



Features

- Surface Mount SOD-123FL package
- Standoff Voltage: 5 to 85 volts
- Power Dissipation: 400 watts
- RoHS compliant*



Shaded models are currently available but not recommended for new designs.

SMF4L Transient Voltage Suppressor Diode Series

General Information

Bourns offers Transient Voltage Suppressor Diodes for surge and ESD protection applications, in compact chip package SOD-123FL size format. The Transient Voltage Suppressor series offers a choice of Working Peak Reverse Voltage from 5 V up to 85 V. Typical fast response times are less than 1.0 picosecond from 0 V to Breakdown Voltage.

Bourns® Chip Diodes conform to JEDEC standards, are easy to handle with standard pick and place equipment and the flat configuration minimizes roll away.

Additional Information

Click these links for more information:



Absolute Maximum Ratings (@ T_A = 25 °C Unless Otherwise Noted)

Parameter	Symbol	Value	Unit
Maximum Peak Pulse Power Dissipation (10/1000 μs) ¹	P _{PPM}	400	W
Peak Forward Surge Current 8.3 ms Single Half Sine Wave Superimposed on Rated Load (JEDEC Method)	I _{FSM}	50	A
Operating Temperature Range	T _J	-55 to +150	°C
Storage Temperature Range	T _{STG}	-55 to +150	°C

¹ Non-repetitive current pulse, per Pulse Waveform graph and derated above T_A = 25 °C.

Electrical Characteristics (@ T_A = 25 °C Unless Otherwise Noted)

Unidirectional Device		Breakdown Voltage V _{BR} (Volts)			Working Peak Reverse Voltage	Maximum Reverse Leakage @ V _{RWM}	Maximum Reverse Voltage @ I _{RSM}	Maximum Reverse Surge Current
Part No.	Marking	Min.	Max.	@ I _T (mA)	V _{RWM} (V)	I _R (μA)	V _{RSM} (V)	I _{RSM} (A)
SMF4L5.0A	KE	6.4	7.00	10	5	400	9.2	21.7
SMF4L6.0A	KG	6.67	7.37	10	6	400	10.3	19.4
SMF4L6.5A	KK	7.22	7.98	10	6.5	250	11.2	17.9
SMF4L7.0A	KM	7.78	8.6	10	7	100	12.0	16.7
SMF4L7.5A	KP	8.33	9.21	1.0	7.5	50	12.9	15.5
SMF4L8.0A	KR	8.89	9.83	1.0	8	25	13.6	14.7
SMF4L8.5A	KT	9.44	10.4	1.0	8.5	10	14.4	13.9
SMF4L9.0A	KV	10	11.1	1.0	9	5	15.4	13.0
SMF4L10A	KX	11.1	12.3	1.0	10	2.5	17.0	11.8
SMF4L11A	KZ	12.2	13.5	1.0	11	2.5	18.2	11.0
SMF4L12A	LE	13.3	14.7	1.0	12	1.0	19.9	20.1
SMF4L13A	LG	14.4	15.9	1.0	13	1.0	21.5	18.6
SMF4L14A	LK	15.6	17.2	1.0	14	1.0	23.2	17.2
SMF4L15A	LM	16.7	18.5	1.0	15	1.0	24.4	16.4
SMF4L16A	LP	17.8	19.7	1.0	16	1.0	26.0	15.4
SMF4L17A	LR	18.9	20.9	1.0	17	1.0	27.6	14.5
SMF4L18A	LT	20.0	22.1	1.0	18	1.0	29.2	13.7

~ Continued on next page ~



WARNING Cancer and Reproductive Harm - www.P65Warnings.ca.gov

*RoHS Directive 2015/863, Mar 31, 2015 and Annex.

Specifications are subject to change without notice.

Users should verify actual device performance in their specific applications.

The products described herein and this document are subject to specific legal disclaimers as set forth on the last page of this document, and at www.bourns.com/docs/legal/disclaimer.pdf.

Applications

- Protection of power buses
- Protection of I/O interfaces
- Overvoltage transient protection
- Telecom, computer, industrial and consumer electronics applications



Shaded models are currently available but not recommended for new designs.

SMF4L Transient Voltage Suppressor Diode Series

BOURNS®

Electrical Characteristics - Continued (@ T_A = 25 °C Unless Otherwise Noted)

Unidirectional Device		Breakdown Voltage V _{BR} (Volts)			Working Peak Reverse Voltage	Maximum Reverse Leakage @ V _{RWM}	Maximum Reverse Voltage @ I _{RSM}	Maximum Reverse Surge Current
Part No.	Marking	Min.	Max.	@ I _T (mA)	V _{RWM} (V)	I _R (μA)	V _{RSM} (V)	I _{RSM} (A)
SMF4L20A	LV	22.2	24.5	1.0	20	1.0	32.4	12.3
SMF4L22A	LX	24.4	26.9	1.0	22	1.0	35.5	11.3
SMF4L24A	LZ	26.7	29.5	1.0	24	1.0	38.9	10.3
SMF4L26A	ME	28.9	31.9	1.0	26	1.0	42.1	9.5
SMF4L28A	MG	31.1	34.4	1.0	28	1.0	45.4	8.8
SMF4L30A	MK	33.3	36.8	1.0	30	1.0	48.4	8.3
SMF4L33A	MM	36.7	40.6	1.0	33	1.0	53.3	7.5
SMF4L36A	MP	40.0	44.2	1.0	36	1.0	58.1	6.9
SMF4L40A	MR	44.4	49.1	1.0	40	1.0	64.5	6.2
SMF4L43A	MT	47.8	52.8	1.0	43	1.0	69.4	5.8
SMF4L45A	MV	50.0	55.3	1.0	45	1.0	72.7	5.5
SMF4L48A	MX	53.3	58.9	1.0	48	1.0	77.4	5.2
SMF4L51A	MZ	56.7	62.7	1.0	51	1.0	82.4	4.9
SMF4L54A	NE	60.0	66.3	1.0	54	1.0	87.1	4.6
SMF4L58A	NG	64.4	71.2	1.0	58	1.0	93.6	4.3
SMF4L60A	NK	66.7	73.7	1.0	60	1.0	96.8	3.6
SMF4L64A	NM	71.1	78.6	1.0	64	1.0	103.0	3.4
SMF4L70A	NP	77.8	86.0	1.0	70	1.0	113.0	3.0
SMF4L75A	NR	83.3	92.1	1.0	75	1.0	121.0	2.8
SMF4L78A	NT	86.7	95.8	1.0	78	1.0	126.0	2.8
SMF4L85A	NV	94.4	104.0	1.0	85	1.0	137.0	2.6

Specifications are subject to change without notice.

Users should verify actual device performance in their specific applications.

The products described herein and this document are subject to specific legal disclaimers as set forth on the last page of this document, and at www.bourns.com/docs/legal/disclaimer.pdf.

SMF4L Transient Voltage Suppressor Diode Series



Performance Graphs

Peak Pulse Power Derating Curve

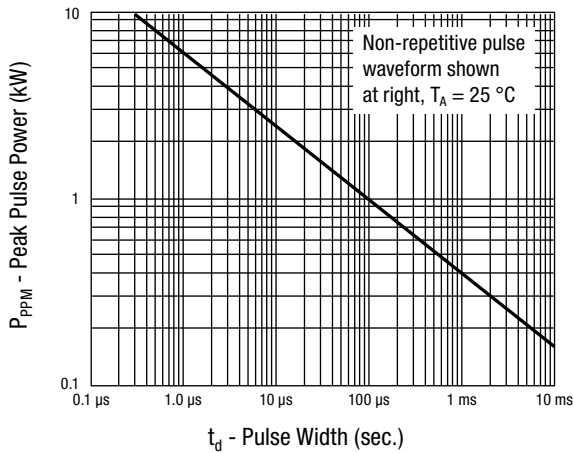

Maximum Non-Repetitive Surge Current

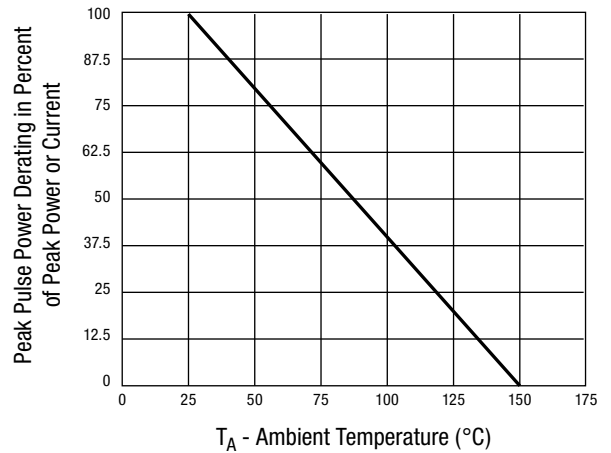

Pulse Waveform

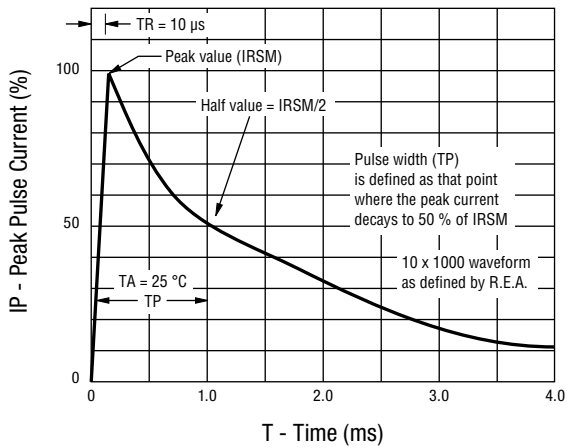

Steady State Power Derating Curve

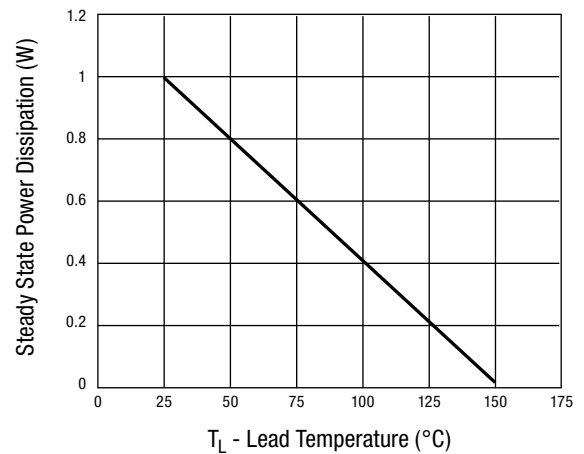

Typ. Junction Capacitance vs. Reverse Breakdown Voltage

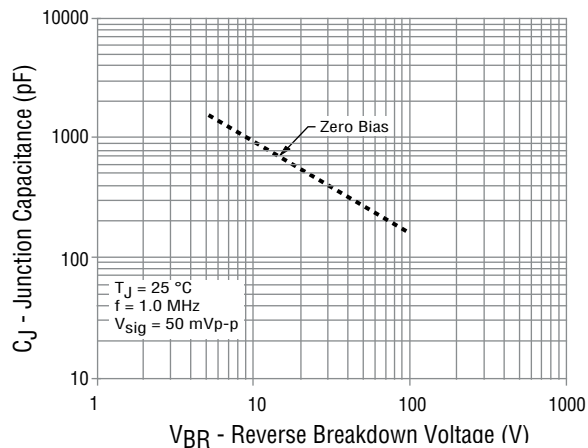

Specifications are subject to change without notice. Users should verify actual device performance in their specific applications. The products described herein and this document are subject to specific legal disclaimers as set forth on the last page of this document, and at www.bourns.com/docs/legal/disclaimer.pdf.

SMF4L Transient Voltage Suppressor Diode Series



Product Dimensions

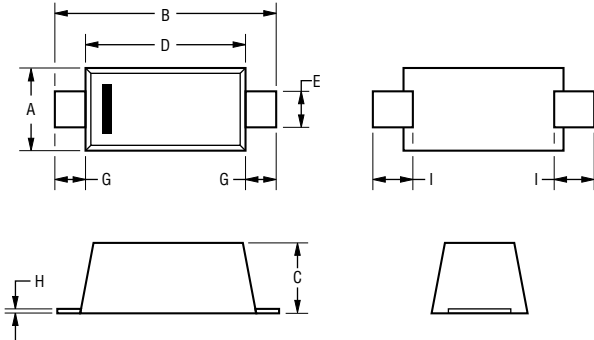

Dimension	SMF (SOD-123FL)
A	1.65 ± 0.25 (0.065 ± 0.01)
B	3.70 ± 0.15 (0.146 ± 0.006)
C	1.125 ± 0.225 (0.044 ± 0.009)
D	2.825 ± 0.275 (0.111 ± 0.011)
E	0.775 ± 0.275 (0.031 ± 0.011)
G	0.400 ± 0.15 (0.016 ± 0.006)
H	0.175 ± 0.075 (0.007 ± 0.003)
I	0.550 ± 0.15 (0.022 ± 0.006)

DIMENSIONS: $\frac{\text{MM}}{\text{(INCHES)}}$

Typical Part Marking

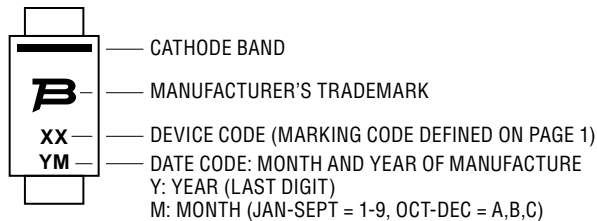

Recommended Footprint

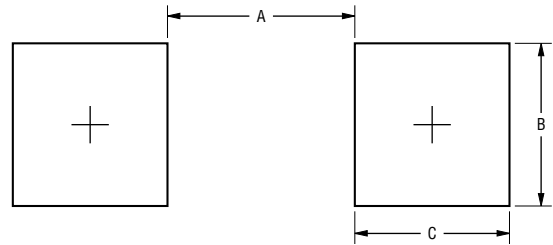

Dimension	SMF (SOD-123FL)
A (Max.)	$\frac{2.36}{(0.093)}$
B (Min.)	$\frac{1.22}{(0.048)}$
C (Min.)	$\frac{0.91}{(0.036)}$

DIMENSIONS: $\frac{\text{MM}}{\text{(INCHES)}}$

Physical Specifications

Case Molded plastic per UL Class 94V-0
Polarity.....Cathode band indicates unidirectional device

How to Order

Package _____ **SMF4L 5.0 A**
SMF4L = 400 W SMF/SOD-123FL Package
Working Peak Reverse Voltage _____
5.0 = 5 V_{RWM} (Volts)
Suffix _____
A = 5 % Tolerance Unidirectional Device

Environmental Specifications

Moisture Sensitivity Level..... 1
ESD Classification (HBM).....3B

SMF4L Transient Voltage Suppressor Diode Series

BOURNS®

Packaging Information

The product will be dispensed in tape and reel format (see diagram below).

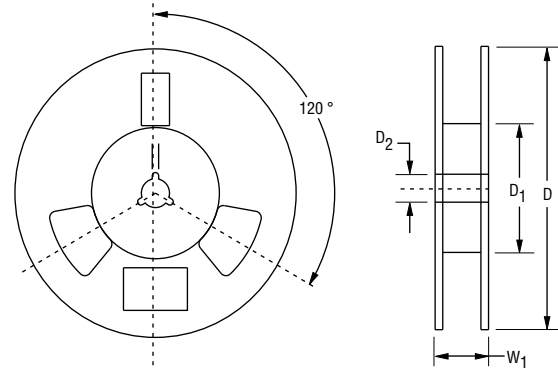
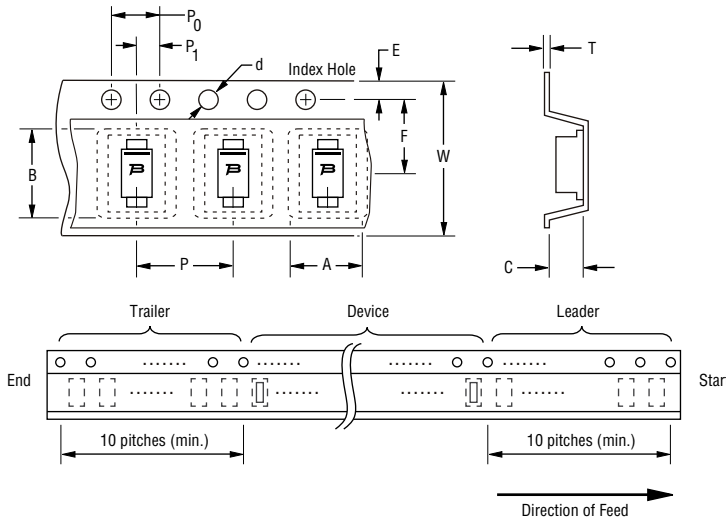

DIMENSIONS: $\frac{\text{MM}}{\text{(INCHES)}}$

Devices are packed in accordance with EIA 481 standard specifications shown here.

Item	Symbol	SMF4L Series
Carrier Width	A	$\frac{1.9 \pm 0.20}{(0.075 \pm 0.008)}$
Carrier Length	B	$\frac{4.01 \pm 0.20}{(0.158 \pm 0.008)}$
Carrier Depth	C	$\frac{1.32 \pm 0.20}{(0.052 \pm 0.008)}$
Sprocket Hole	d	$\frac{1.50 + 0.10 / - 0.00}{(0.059 + 0.004 / - 0.00)}$
Reel Outside Diameter	D	$\frac{178}{(7.008)}$
Reel Inner Diameter	D ₁	$\frac{50.0}{(1.969)}$ MIN.
Feed Hole Diameter	D ₂	$\frac{13.0 + 0.50 / - 0.20}{(0.512 + 0.020 / - 0.008)}$
Sprocket Hole Position	E	$\frac{1.75 \pm 0.10}{(0.069 \pm 0.004)}$
Punch Hole Position	F	$\frac{3.50 \pm 0.05}{(0.138 \pm 0.002)}$
Punch Hole Pitch	P	$\frac{4.00 \pm 0.10}{(0.157 \pm 0.004)}$
Sprocket Hole Pitch	P ₀	$\frac{4.00 \pm 0.10}{(0.157 \pm 0.004)}$
Embossment Center	P ₁	$\frac{2.00 \pm 0.05}{(0.079 \pm 0.002)}$
Overall Tape Thickness	T	$\frac{0.40}{(0.016)}$ MAX.
Tape Width	W	$\frac{8.00 \pm 0.30}{(0.315 \pm 0.012)}$
Reel Width	W ₁	$\frac{14.4}{(5.669)}$ MAX.
Quantity per Reel	--	2,500

BOURNS®

Asia-Pacific:

Tel: +886-2 2562-4117

Email: asiacus@bourns.com

Europe:

Tel: +36 88 885 877

Email: eurocus@bourns.com

The Americas:

Tel: +1-951 781-5500

Email: americus@bourns.com

www.bourns.com

REV. 12/21

Specifications are subject to change without notice.

Users should verify actual device performance in their specific applications.

The products described herein and this document are subject to specific legal disclaimers as set forth on the last page of this document, and at www.bourns.com/docs/legal/disclaimer.pdf.

This legal disclaimer applies to purchasers and users of Bourns® products manufactured by or on behalf of Bourns, Inc. and its affiliates (collectively, "Bourns").

Unless otherwise expressly indicated in writing, Bourns® products and data sheets relating thereto are subject to change without notice. Users should check for and obtain the latest relevant information and verify that such information is current and complete before placing orders for Bourns® products.

The characteristics and parameters of a Bourns® product set forth in its data sheet are based on laboratory conditions, and statements regarding the suitability of products for certain types of applications are based on Bourns' knowledge of typical requirements in generic applications. The characteristics and parameters of a Bourns® product in a user application may vary from the data sheet characteristics and parameters due to (i) the combination of the Bourns® product with other components in the user's application, or (ii) the environment of the user application itself. The characteristics and parameters of a Bourns® product also can and do vary in different applications and actual performance may vary over time. Users should always verify the actual performance of the Bourns® product in their specific devices and applications, and make their own independent judgments regarding the amount of additional test margin to design into their device or application to compensate for differences between laboratory and real world conditions.

Unless Bourns has explicitly designated an individual Bourns® product as meeting the requirements of a particular industry standard (e.g., ISO/TS 16949) or a particular qualification (e.g., UL listed or recognized), Bourns is not responsible for any failure of an individual Bourns® product to meet the requirements of such industry standard or particular qualification. Users of Bourns® products are responsible for ensuring compliance with safety-related requirements and standards applicable to their devices or applications.

Bourns® products are not recommended, authorized or intended for use in nuclear, lifesaving, life-critical or life-sustaining applications, nor in any other applications where failure or malfunction may result in personal injury, death, or severe property or environmental damage. Unless expressly and specifically approved in writing by two authorized Bourns representatives on a case-by-case basis, use of any Bourns® products in such unauthorized applications might not be safe and thus is at the user's sole risk. Life-critical applications include devices identified by the U.S. Food and Drug Administration as Class III devices and generally equivalent classifications outside of the United States.

Bourns expressly identifies those Bourns® standard products that are suitable for use in automotive applications on such products' data sheets in the section entitled "Applications." Unless expressly and specifically approved in writing by two authorized Bourns representatives on a case-by-case basis, use of any other Bourns® standard products in an automotive application might not be safe and thus is not recommended, authorized or intended and is at the user's sole risk. If Bourns expressly identifies a sub-category of automotive application in the data sheet for its standard products (such as infotainment or lighting), such identification means that Bourns has reviewed its standard product and has determined that if such Bourns® standard product is considered for potential use in automotive applications, it should only be used in such sub-category of automotive applications. Any reference to Bourns® standard product in the data sheet as compliant with the AEC-Q standard or "automotive grade" does not by itself mean that Bourns has approved such product for use in an automotive application.

Bourns® standard products are not tested to comply with United States Federal Aviation Administration standards generally or any other generally equivalent governmental organization standard applicable to products designed or manufactured for use in aircraft or space applications. Bourns expressly identifies Bourns® standard products that are suitable for use in aircraft or space applications on such products' data sheets in the section entitled "Applications." Unless expressly and specifically approved in writing by two authorized Bourns representatives on a case-by-case basis, use of any other Bourns® standard product in an aircraft or space application might not be safe and thus is not recommended, authorized or intended and is at the user's sole risk.

The use and level of testing applicable to Bourns® custom products shall be negotiated on a case-by-case basis by Bourns and the user for which such Bourns® custom products are specially designed. Absent a written agreement between Bourns and the user regarding the use and level of such testing, the above provisions applicable to Bourns® standard products shall also apply to such Bourns® custom products.

Users shall not sell, transfer, export or re-export any Bourns® products or technology for use in activities which involve the design, development, production, use or stockpiling of nuclear, chemical or biological weapons or missiles, nor shall they use Bourns® products or technology in any facility which engages in activities relating to such devices. The foregoing restrictions apply to all uses and applications that violate national or international prohibitions, including embargos or international regulations. Further, Bourns® products and Bourns technology and technical data may not under any circumstance be exported or re-exported to countries subject to international sanctions or embargoes. Bourns® products may not, without prior authorization from Bourns and/or the U.S. Government, be resold, transferred, or re-exported to any party not eligible to receive U.S. commodities, software, and technical data.

To the maximum extent permitted by applicable law, Bourns disclaims (i) any and all liability for special, punitive, consequential, incidental or indirect damages or lost revenues or lost profits, and (ii) any and all implied warranties, including implied warranties of fitness for particular purpose, non-infringement and merchantability.

For your convenience, copies of this Legal Disclaimer Notice with German, Spanish, Japanese, Traditional Chinese and Simplified Chinese bilingual versions are available at:

Web Page: <http://www.bourns.com/legal/disclaimers-terms-and-policies>

PDF: <http://www.bourns.com/docs/Legal/disclaimer.pdf>

单击下面可查看定价，库存，交付和生命周期等信息

[>>Bourns\(伯恩斯\)](#)