

SPECIFICATION

PROD. NAME	SHIELDED POWER INDUCTOR	PART NO.	SRN2512-4R7M
		REF	20150618

I. CONFIGURATION & DIMENSIONS :

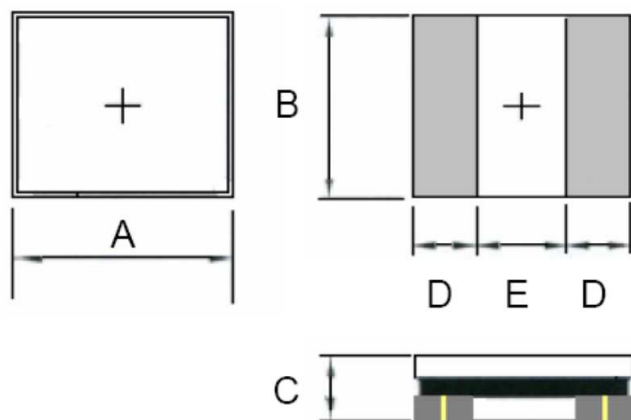

Chip Size:mm
 A: 2.5 -0.1/+0.2
 B: 2.0 -0.05/+ 0.35
 C: 1.2 max.
 D: 0.85 ref.
 E: 0.80 ref.

II. SCHEMATIC DIAGRAM:

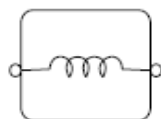

III. RECOMMENDED PCB PATTERN:

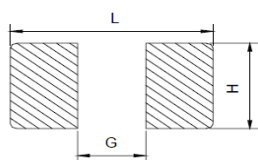

Unit:mm
 G: 0.8
 H: 2.1
 L: 2.6

IV. GENERAL SPECIFICATION :

- a. Temp. rise : 40°Cmax.(ΔT)
- b. All test data referenced to 25°C ambient.
- c. Operating Temperature : -40~+125°C
- d. Storage temperature and Humidity range : -40~+125°C ; 50~60%RH
- e. 100% Lead(Pb) & Halogen-Free and RoHS compliant.
- f. Reflow times: 3times max.

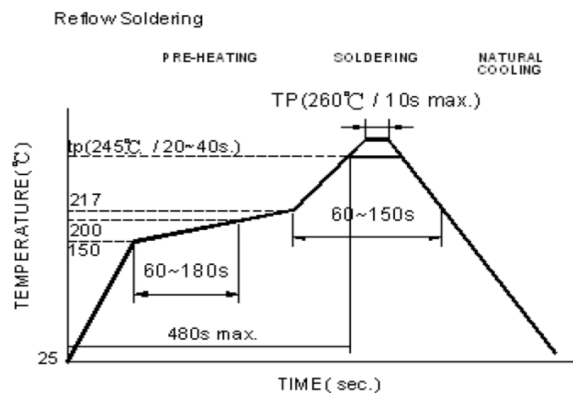

BOURNS INDUCTIVE COMPONENTS

SPECIFICATION

PROD. NAME	SHIELDED POWER INDUCTOR	PART NO.	SRN2512-4R7M
		REF	20150618

V. ELECTRICAL CHARACTERISTICS :

PART NO.	Inductance L (uH)	Rdc(Ω) max. $\pm 20\%$	Isat(A) typ.	Irms(A) typ.
	$\pm 20\%$ @0A			
SRN2512-4R7M	4.7	0.176	1.5	1.2

Note:

1. Test frequency of L : 1MHz / 0.1V
2. Saturation Current (Isat) will cause L to drop approximately 30% typical.
3. Heat Rated Current (Irms) will cause the coil temperature rise approximately $\Delta t \leq 40.^\circ\text{C}$

VI. TYPICAL PERFORMANCE CURVES:

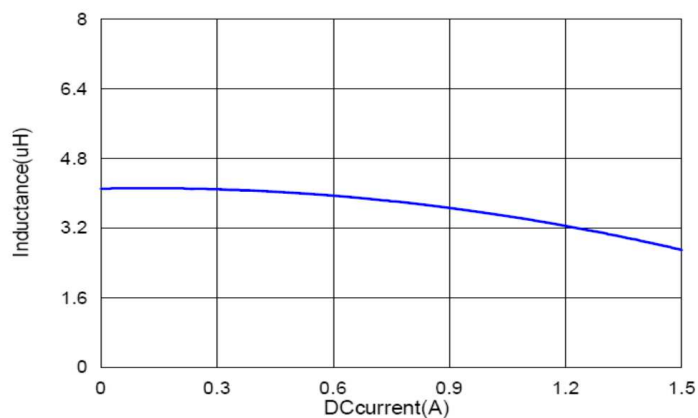

SPECIFICATION

PROD. NAME	SHIELDED POWER INDUCTOR	PART NO.	SRN2512-4R7M
		REF	20150618

VII. PACKAGING INFORMATION

(1) Tape packaging dimensions

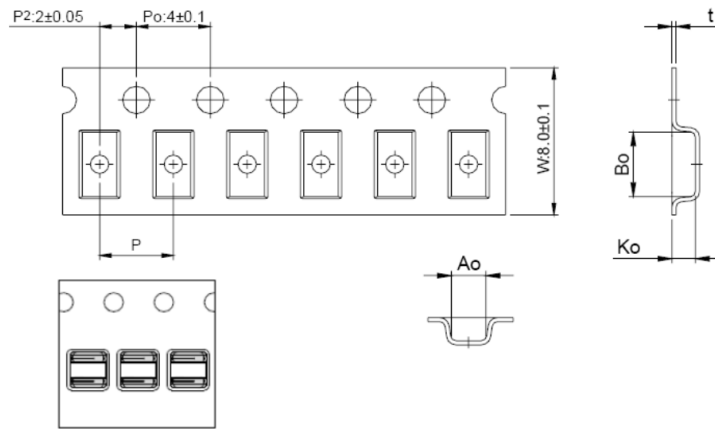

Bottom View

unit:mm

Bo(mm)	Ao(mm)	Ko(mm)	P(mm)	t(mm)
2.85±0.1	2.45±0.1	1.40±0.1	4.0±0.1	0.23±0.05

(2) Reel dimensions

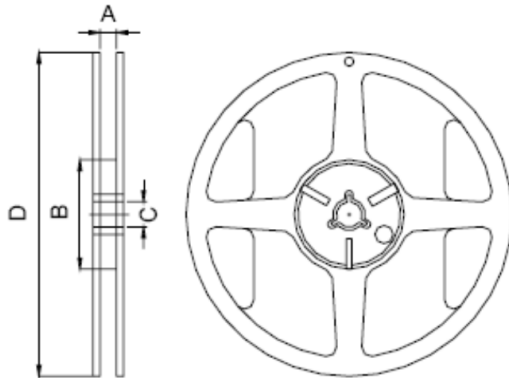

7"x8mm

Type	A(mm)	B(mm)	C(mm)	D(mm)
7"x8mm	8.4±1.0	50 min.	13±0.8	178±2

(3) Packaging Quantity

reel type : 2000 pcs./reel

SPECIFICATION

PROD. NAME	SHIELDED POWER INDUCTOR	PART NO.	SRN2512-4R7M
		REF	20150618

VIII. RELIABILITY TEST :

Test item	Specification and Requirement	Test Conditions			
Solder Heat Resistance	Appearance : No damage. Inductance : within±10% of initial value Q : Shall not exceed the specification value. RDC : within ±15% of initial value and shall not exceed the specification value	Temperature (°C)	Time (s)	Temperature ramp/immersion and emersion rate	Number of heat cycles
		200 ±5 (solder temp)	10 ±1	25mm/s±8 mm/s	1
		Depth: completely cover the termination			
Solderability Test	More than 95% of terminal electrode should be covered with solder.	Preheat: 150°C,60sec. ° Solder: Sn99.5%-Cu0. 5% ° Temperature: 245±5°C ° Flux for lead free: Rosin. 9.5% ° Dip time: 4±1sec ° Depth: completely cover the termination			
Life Test		Preconditioning:Run through IR reflow for 2 times.(IPC/JEDEC J-STD-020DClassification Reflow Profiles Temperature : 125±2°C (Bead) Temperature : 85±2°C (Inductor) Applied current : rated current Duration : 1000±12hrs Measured at room temperature after placing for 24±2 hrs			
Thermal shock	Appearance : No damage. Inductance : within±10% of initial value Q : Shall not exceed the specification value. RDC : within ±15% of initial value and shall not exceed the specification value	Preconditioning:Run through IR reflow for 2 times.(IPC/JEDEC J-STD-020DClassification Reflow Profiles Step1 : -40±2°C 30±5min Step2 : 25±2°C ≤0.5min Step3 : 105±2°C 30±5min Number of cycles : 500 Measured at room femprature after placing for 24±2 hrs			
Humidity Resistance Test		Preconditioning:Run through IR reflow for 2 times.(IPC/JEDEC J-STD-020DClassification Reflow Profiles Humidity : 85±2% R.H, Temperature : 85°C ±2°C Duration : 1000hrs Min. with 100% rated current Measured at room temperature after placing for 24±2			
Vibration Test		Preconditioning:Run through IR reflow for 2 times.(IPC/JEDEC J-STD-020DClassification Reflow Profiles Oscillation Frequency: 10~2K~10Hz for 20 minutes Equipment : Vibration checker Total Amplitude:1.52mm±10% Testing Time : 12 hours(20 minutes, 12 cycles each of 3 orientations) °			

BOURNS INDUCTIVE COMPONENTS

单击下面可查看定价，库存，交付和生命周期等信息

[>>Bourns\(伯恩斯\)](#)