

## Features

- Lead free device (RoHS Compliant\*)
- Protects 8 lines
- Unidirectional & bidirectional configurations
- ESD protection

## Applications

- Audio/video inputs
- RS-232, RS-422 & RS-423 data lines
- Portable electronics
- Medical sensors

# CDNBS16-T03~T36C – TVS Diode Array Series

### General Information

The markets of portable communications, computing and video equipment are challenging the semiconductor industry to develop increasingly smaller electronic components.

Bourns offers Transient Voltage Suppressor Array diodes for surge and ESD protection applications, in 16 Lead Narrow Body SOIC package size format. The Transient Voltage Suppressor Array series offer a choice of voltage types ranging from 3 V to 36 V in unidirectional and bidirectional configurations. Bourns® Chip Diodes conform to JEDEC standards, are easy to handle on standard pick and place equipment and their flat configuration minimizes roll away.

The Bourns® device will meet IEC 61000-4-2 (ESD), IEC 61000-4-4 (EFT) and IEC 61000-4-5 (Surge) requirements.

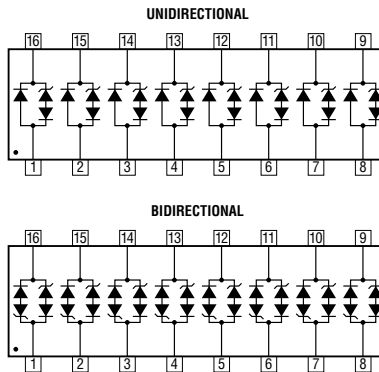

### Additional Information

Click these links for more information:



**WARNING**  
Cancer and Reproductive Harm  
[www.P65Warnings.ca.gov](http://www.P65Warnings.ca.gov)

\*RoHS Directive 2015/863, Mar 31, 2015 and Annex. Specifications are subject to change without notice. Users should verify actual device performance in their specific applications. The products described herein and this document are subject to specific legal disclaimers as set forth on the last page of this document, and at [www.bourns.com/docs/legal/disclaimer.pdf](http://www.bourns.com/docs/legal/disclaimer.pdf).

### Thermal Characteristics (T<sub>A</sub> = 25 °C (Unless Otherwise Noted))

Parameter	Symbol	Max.	Unit
Operating Temperature	T <sub>J</sub>	-55 °C to +150	°C
Storage Temperature	T <sub>STG</sub>	-55 °C to +150	°C

### Electrical Characteristics (@ T<sub>A</sub> = 25 °C Unless Otherwise Noted)

Parameter	Symbol	CDNBS16-														Unit
		Uni-T03	Bi-T03C	Uni-T05	Bi-T05C	Uni-T08	Bi-T08C	Uni-T12	Bi-T12C	Uni-T15	Bi-T15C	Uni-T24	Bi-T24C	Uni-T36	Bi-T36C	
Min. Breakdown Voltage @ 1 mA	V <sub>BR</sub>	4.5	6.0	8.5	13.3	16.7	26.7	40.0							V	
Working Peak Voltage	V <sub>WM</sub>	3.0	5.0	8.0	12.0	15.0	24.0	36.0							V	
Max. Clamping Voltage V <sub>C</sub> @ I <sub>P</sub> = 1 A <sup>1</sup>	V <sub>C</sub>	8.0	9.8	13.4	19.0	25.5	40.0	53.0							V	
Typ. Clamping Voltage @ 8/20 μs V <sub>C</sub> @ I <sub>PP</sub> <sup>1</sup>	V <sub>C</sub>	23 V @ 43 A	24 V @ 42 A	26 V @ 30 A	33 V @ 21 A	39 V @ 15 A	57 V @ 10 A	72 V @ 7 A							V	
Max. Leakage Current @ V <sub>WM</sub>	I <sub>D</sub>	125	20	10	2	2	2	2							μA	
Maximum Capacitance @ 0 V, 1 MHz	C <sub>J(SD)</sub>	15														pF
Temperature Coefficient of V <sub>BR</sub>		-3	3	9	16	17	26	36							mv/°C	
Peak Pulse Power (t <sub>p</sub> = 8/20 μs) <sup>2</sup>	P <sub>PP</sub>	500														W
Forward Voltage @ 100 mA, 300 μs - Square Wave <sup>3</sup>	V <sub>F</sub>	1.5														V

Notes:

1. See Pulse Wave Form.
2. See Peak Pulse Power vs. Pulse Time.
3. Only applies to unidirectional devices.
4. Part numbers with a "C" suffix are bidirectional devices, i.e. CDNBS16-T03C

# CDNBS16-T03~T36C – TVS Diode Array Series



## Mechanical Characteristics

This is a molded JEDEC Narrow Body SO-16 package with lead free 100 % Sn plating on the lead frame. It weighs approximately 30 mg and has a flammability rating of UL 94V-0.

### Product Dimensions

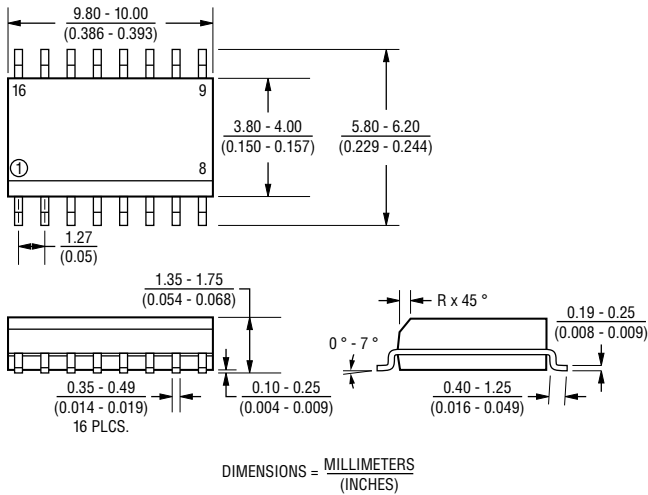

### Recommended Footprint

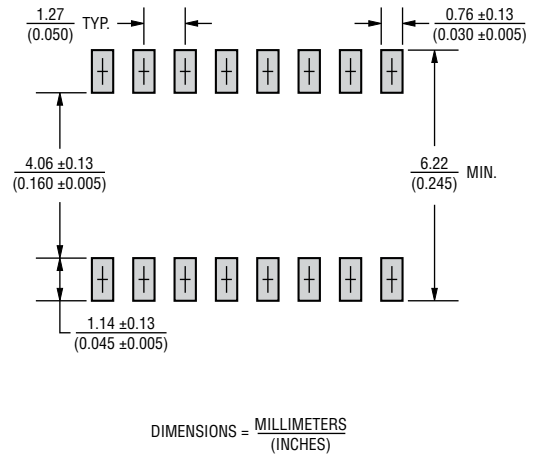

### Typical Part Marking

CDNBS16-T03.....	CDNBS16-T03
CDNBS16-T05.....	CDNBS16-T05
CDNBS16-T08.....	CDNBS16-T08
CDNBS16-T12.....	CDNBS16-T12
CDNBS16-T15.....	CDNBS16-T15
CDNBS16-T24.....	CDNBS16-T24
CDNBS16-T36.....	CDNBS16-T36
CDNBS16-T03C.....	CDNBS16-T03C
CDNBS16-T05C.....	CDNBS16-T05C
CDNBS16-T08C.....	CDNBS16-T08C
CDNBS16-T12C.....	CDNBS16-T12C
CDNBS16-T15C.....	CDNBS16-T15C
CDNBS16-T24C.....	CDNBS16-T24C
CDNBS16-T36C.....	CDNBS16-T36C

### How to Order

Common Code	CD NBS16 - T 03 C
Package	NBS16 = 16L NSOIC Package
Model	T = Transient Voltage Suppressor
Working Peak Reverse Voltage	03 = 3 V <sub>RWM</sub> (Volts)
Suffix	C = Bidirectional Diode

Specifications are subject to change without notice.

Users should verify actual device performance in their specific applications.

The products described herein and this document are subject to specific legal disclaimers as set forth on the last page of this document, and at [www.bourns.com/docs/legal/disclaimer.pdf](http://www.bourns.com/docs/legal/disclaimer.pdf).

## Performance Graphs

### Peak Pulse Power vs Pulse Time

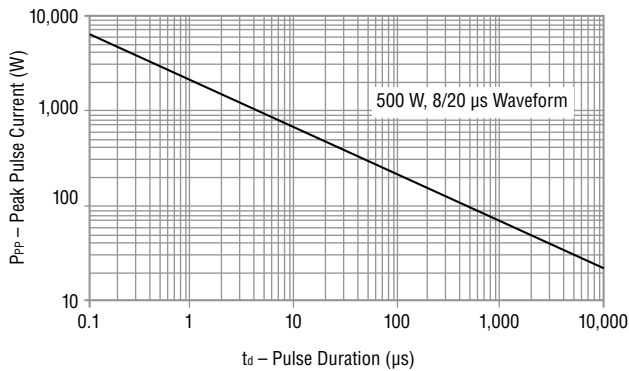

### Pulse Wave Form

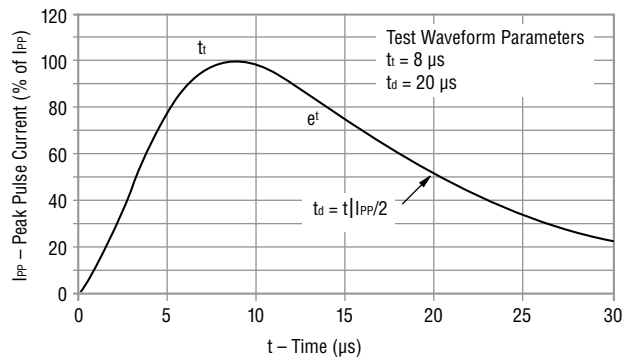

### Block Diagram

The device block diagrams below include the pin names and basic electrical connections associated with each channel.

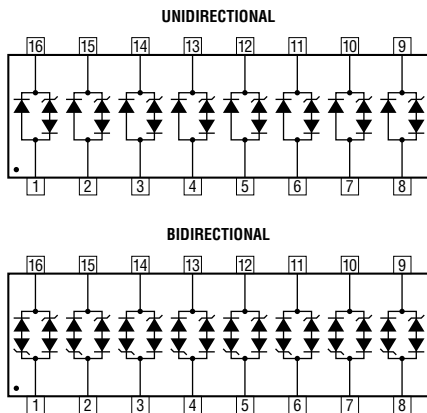

### Power Derating Curve

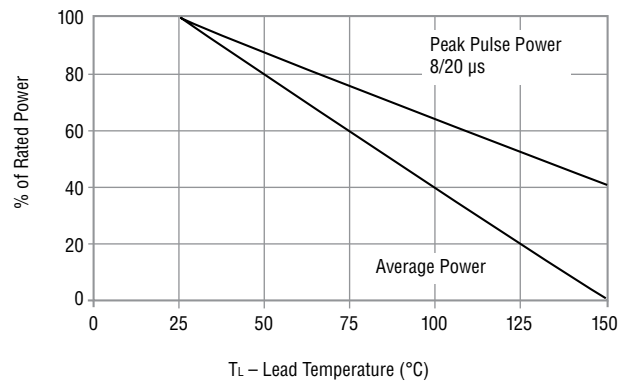

### Device Pinout

Pin	Function	Pin	Function
1	GND	1	I/O 1
2	GND	2	I/O 2
3	GND	3	I/O 3
4	GND	4	I/O 4
5	GND	5	I/O 5
6	GND	6	I/O 6
7	GND	7	I/O 7
8	GND	8	I/O 8

Specifications are subject to change without notice.

Users should verify actual device performance in their specific applications.

The products described herein and this document are subject to specific legal disclaimers as set forth on the last page of this document, and at [www.bourns.com/docs/legal/disclaimer.pdf](http://www.bourns.com/docs/legal/disclaimer.pdf).

# CDNBS16-T03~T36C – TVS Diode Array Series

**BOURNS®**

## Packaging Information

The product will be dispensed in Tape and Reel format (see diagram below).

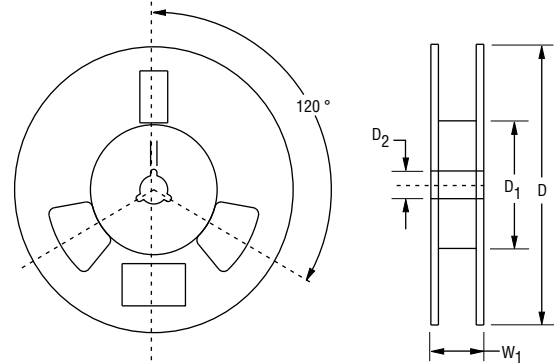
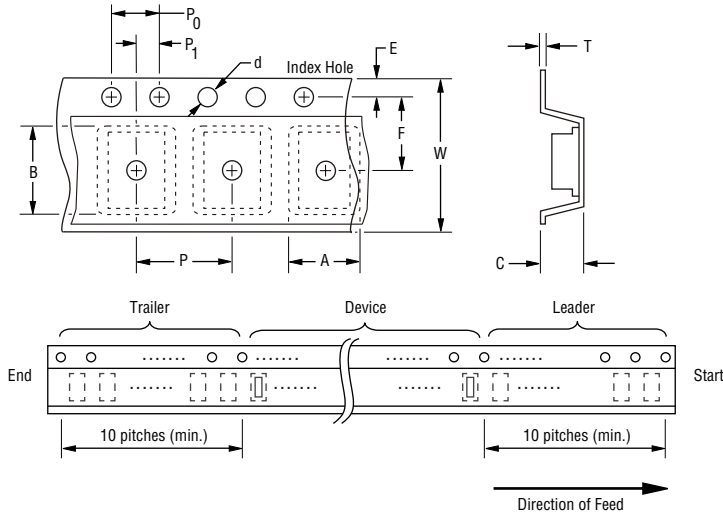

DIMENSIONS:  $\frac{\text{MM}}{\text{(INCHES)}}$

Devices are packed in accordance with EIA standard RS-481-A.

Item	Symbol	NSOIC 16L
Carrier Width	A	$\frac{6.7 \pm 0.10}{(0.264 \pm 0.004)}$
Carrier Length	B	$\frac{10.5 \pm 0.10}{(0.413 \pm 0.004)}$
Carrier Depth	C	$\frac{2.10 \pm 0.10}{(0.083 \pm 0.004)}$
Sprocket Hole	d	$\frac{1.55 \pm 0.05}{(0.061 \pm 0.002)}$
Reel Outside Diameter	D	$\frac{330}{(12.992)}$
Reel Inner Diameter	D <sub>1</sub>	$\frac{80.0}{(3.150)}$ Min.
Feed Hole Diameter	D <sub>2</sub>	$\frac{13.0 \pm 0.20}{(0.512 \pm 0.008)}$
Sprocket Hole Position	E	$\frac{1.75 \pm 0.10}{(0.069 \pm 0.004)}$
Punch Hole Position	F	$\frac{3.50 \pm 0.05}{(0.138 \pm 0.002)}$
Punch Hole Pitch	P	$\frac{8.00 \pm 0.10}{(0.314 \pm 0.004)}$
Sprocket Hole Pitch	P <sub>0</sub>	$\frac{4.00 \pm 0.10}{(0.157 \pm 0.004)}$
Embossment Center	P <sub>1</sub>	$\frac{2.00 \pm 0.05}{(0.079 \pm 0.002)}$
Overall Tape Thickness	T	$\frac{0.20 \pm 0.10}{(0.008 \pm 0.004)}$
Tape Width	W	$\frac{16.00 \pm 0.20}{(0.630 \pm 0.008)}$
Reel Width	W <sub>1</sub>	$\frac{18.4}{(0.724)}$ Max.
Quantity per Reel	—	2,500

**BOURNS®**

**Asia-Pacific:** Tel: +886-2 2562-4117  
Email: asiacus@bourns.com

**EMEA:** Tel: +36 88 885 877  
Email: eurocus@bourns.com

**The Americas:** Tel: +1-951 781-5500  
Email: americus@bourns.com

**www.bourns.com**

REV. 07/11

Specifications are subject to change without notice.  
Users should verify actual device performance in their specific applications.  
The products described herein and this document are subject to specific legal disclaimers as set forth on the last page of this document, and at [www.bourns.com/docs/legal/disclaimer.pdf](http://www.bourns.com/docs/legal/disclaimer.pdf).

This legal disclaimer applies to purchasers and users of Bourns® products manufactured by or on behalf of Bourns, Inc. and its affiliates (collectively, "Bourns").

Unless otherwise expressly indicated in writing, Bourns® products and data sheets relating thereto are subject to change without notice. Users should check for and obtain the latest relevant information and verify that such information is current and complete before placing orders for Bourns® products.

The characteristics and parameters of a Bourns® product set forth in its data sheet are based on laboratory conditions, and statements regarding the suitability of products for certain types of applications are based on Bourns' knowledge of typical requirements in generic applications. The characteristics and parameters of a Bourns® product in a user application may vary from the data sheet characteristics and parameters due to (i) the combination of the Bourns® product with other components in the user's application, or (ii) the environment of the user application itself. The characteristics and parameters of a Bourns® product also can and do vary in different applications and actual performance may vary over time. Users should always verify the actual performance of the Bourns® product in their specific devices and applications, and make their own independent judgments regarding the amount of additional test margin to design into their device or application to compensate for differences between laboratory and real world conditions.

Unless Bourns has explicitly designated an individual Bourns® product as meeting the requirements of a particular industry standard (e.g., ISO/TS 16949) or a particular qualification (e.g., UL listed or recognized), Bourns is not responsible for any failure of an individual Bourns® product to meet the requirements of such industry standard or particular qualification. Users of Bourns® products are responsible for ensuring compliance with safety-related requirements and standards applicable to their devices or applications.

Bourns® products are not recommended, authorized or intended for use in nuclear, lifesaving, life-critical or life-sustaining applications, nor in any other applications where failure or malfunction may result in personal injury, death, or severe property or environmental damage. Unless expressly and specifically approved in writing by two authorized Bourns representatives on a case-by-case basis, use of any Bourns® products in such unauthorized applications might not be safe and thus is at the user's sole risk. Life-critical applications include devices identified by the U.S. Food and Drug Administration as Class III devices and generally equivalent classifications outside of the United States.

Bourns expressly identifies those Bourns® standard products that are suitable for use in automotive applications on such products' data sheets in the section entitled "Applications." Unless expressly and specifically approved in writing by two authorized Bourns representatives on a case-by-case basis, use of any other Bourns® standard products in an automotive application might not be safe and thus is not recommended, authorized or intended and is at the user's sole risk. If Bourns expressly identifies a sub-category of automotive application in the data sheet for its standard products (such as infotainment or lighting), such identification means that Bourns has reviewed its standard product and has determined that if such Bourns® standard product is considered for potential use in automotive applications, it should only be used in such sub-category of automotive applications. Any reference to Bourns® standard product in the data sheet as compliant with the AEC-Q standard or "automotive grade" does not by itself mean that Bourns has approved such product for use in an automotive application.

Bourns® standard products are not tested to comply with United States Federal Aviation Administration standards generally or any other generally equivalent governmental organization standard applicable to products designed or manufactured for use in aircraft or space applications. Bourns expressly identifies Bourns® standard products that are suitable for use in aircraft or space applications on such products' data sheets in the section entitled "Applications." Unless expressly and specifically approved in writing by two authorized Bourns representatives on a case-by-case basis, use of any other Bourns® standard product in an aircraft or space application might not be safe and thus is not recommended, authorized or intended and is at the user's sole risk.

The use and level of testing applicable to Bourns® custom products shall be negotiated on a case-by-case basis by Bourns and the user for which such Bourns® custom products are specially designed. Absent a written agreement between Bourns and the user regarding the use and level of such testing, the above provisions applicable to Bourns® standard products shall also apply to such Bourns® custom products.

Users shall not sell, transfer, export or re-export any Bourns® products or technology for use in activities which involve the design, development, production, use or stockpiling of nuclear, chemical or biological weapons or missiles, nor shall they use Bourns® products or technology in any facility which engages in activities relating to such devices. The foregoing restrictions apply to all uses and applications that violate national or international prohibitions, including embargos or international regulations. Further, Bourns® products and Bourns technology and technical data may not under any circumstance be exported or re-exported to countries subject to international sanctions or embargoes. Bourns® products may not, without prior authorization from Bourns and/or the U.S. Government, be resold, transferred, or re-exported to any party not eligible to receive U.S. commodities, software, and technical data.

To the maximum extent permitted by applicable law, Bourns disclaims (i) any and all liability for special, punitive, consequential, incidental or indirect damages or lost revenues or lost profits, and (ii) any and all implied warranties, including implied warranties of fitness for particular purpose, non-infringement and merchantability.

*For your convenience, copies of this Legal Disclaimer Notice with German, Spanish, Japanese, Traditional Chinese and Simplified Chinese bilingual versions are available at:*

*Web Page:* <http://www.bourns.com/legal/disclaimers-terms-and-policies>

*PDF:* <http://www.bourns.com/docs/Legal/disclaimer.pdf>

单击下面可查看定价，库存，交付和生命周期等信息

[>>Bourns\(伯恩斯\)](#)