



## Features

- RoHS compliant\*
- Surface Mount SMC package
- Standoff Voltage: 5.0 to 170 volts
- Power Dissipation: 3000 watts
- Typical temperature coefficient:  
 $\Delta V_{BR} = 0.1 \% \times V_{BR} @ 25\text{ }^{\circ}\text{C} \times \Delta T$

## Applications

- IEC 61000-4-2 ESD (Min. Level 4)
- IEC 61000-4-4 EFT
- IEC 61000-4-5 Surge

# SMLJ Transient Voltage Suppressor Diode Series

### General Information

The markets of portable communications, computing and video equipment are challenging the semiconductor industry to develop increasingly smaller electronic components.

Bourns offers Transient Voltage Suppressor Diodes for surge and ESD protection applications, in compact chip package DO-214AB (SMC) size format. The Transient Voltage Suppressor series offers a choice of Working Peak Reverse Voltage from 5 V up to 170 V and Breakdown Voltage up to 200 V. Typical fast response times are less than 1.0 ps for unidirectional devices and less than 5.0 ps for bidirectional devices from 0 V to Minimum Breakdown Voltage.

Bourns® Chip Diodes conform to JEDEC standards, are easy to handle with standard pick and place equipment and the flat configuration minimizes roll away.

### Additional Information

Click these links for more information:



### Agency Recognition

Description	
UL	File Number: <a href="#">E153537</a>

### Electrical Characteristics (@ T<sub>A</sub> = 25 °C Unless Otherwise Noted)

Parameter	Symbol	Value	Unit
Minimum Peak Pulse Power Dissipation (T <sub>p</sub> = 1 ms) (Note 1,2)	P <sub>PK</sub>	3000	Watts
Peak Forward Surge Current 8.3 ms Single Half Sine Wave Superimposed on Rated Load (JEDEC Method) (Note 3)	I <sub>FSM</sub>	300	Amps
Steady State Power Dissipation @ T <sub>L</sub> = 75 °C	P <sub>M(AV)</sub>	5.0	Watts
Maximum Instantaneous Forward Voltage @ I <sub>pp</sub> = 100 A (For Unidirectional Units Only)	V <sub>F</sub>	3.5 5.0	Volts
Operating Temperature Range	T <sub>J</sub>	-55 to +150	°C
Storage Temperature Range	T <sub>STG</sub>	-55 to +150	°C

1. Non-repetitive current pulse, per Pulse Waveform graph and derated above T<sub>A</sub> = 25 °C per Pulse Derating Curve.
2. Thermal Resistance Junction to Lead.
3. 8.3 ms Single Sine Wave duty cycle = 4 pulses maximum per minute (unidirectional units only).



**Asia-Pacific:** Tel: +886-2 2562-4117 • Email: [asiacus@bourns.com](mailto:asiacus@bourns.com)

**EMEA:** Tel: +36 88 885 877 • Email: [eurocus@bourns.com](mailto:eurocus@bourns.com)

**The Americas:** Tel: +1-951 781-5500 • Email: [americus@bourns.com](mailto:americus@bourns.com)

[www.bourns.com](http://www.bourns.com)

### How to Order

	<b>SMLJ 5.0 CA - H</b>
Package	SMLJ = SMC/DO-214AB
Working Peak Reverse Voltage	5.0 = 5.0 V <sub>RWM</sub> (Volts)
Suffix	A = 5 % Tolerance Unidirectional Device CA = 5 % Tolerance Bidirectional Device
Reel	(blank) = 13 inch reel -H = 7 inch reel



**WARNING Cancer and Reproductive Harm - [www.P65Warnings.ca.gov](http://www.P65Warnings.ca.gov)**

\*RoHS Directive 2015/863, Mar 31, 2015 and Annex.

Specifications are subject to change without notice.

Users should verify actual device performance in their specific applications.

The products described herein and this document are subject to specific legal disclaimers as set forth on the last page of this document, and at [www.bourns.com/docs/legal/disclaimer.pdf](http://www.bourns.com/docs/legal/disclaimer.pdf).

# SMLJ Transient Voltage Suppressor Diode Series

**BOURNS®**

## Electrical Characteristics (@ T<sub>A</sub> = 25 °C Unless Otherwise Noted)

Unidirectional Device		Bidirectional Device		Breakdown Voltage V <sub>BR</sub> (Volts)			Working Peak Reverse Voltage	Maximum Reverse Leakage @ V <sub>RWM</sub>	Maximum Clamping Voltage @ I <sub>pp</sub> (10/1000 μs)	Maximum Peak Pulse Current (10/1000 μs)	Maximum Clamping Voltage @ I <sub>pp</sub> (8/20 μs)	Maximum Peak Pulse Current (8/20 μs)
Part Number	Part Marking	Part Number	Part Marking	Min.	Max.	@ I <sub>T</sub> (mA)	V <sub>RWM</sub> (V)	I <sub>R</sub> (μA)	V <sub>C</sub> (V)	I <sub>pp</sub> (A)	V <sub>C</sub> (V)	I <sub>pp</sub> (A)
SMLJ5.0A	HDE	SMLJ5.0CA	IDE	6.40	7.00	10	5	1000	9.2	326.00	12.00	1630.50
SMLJ6.0A	HDG	SMLJ6.0CA	IDG	6.67	7.37	10	6	1000	10.3	291.30	13.40	1456.50
SMLJ6.5A	HDK	SMLJ6.5CA	IDK	7.22	7.98	10	6.5	500	11.2	267.90	14.60	1339.50
SMLJ7.0A	HDM	SMLJ7.0CA	IDM	7.78	8.60	10	7	200	12	250.00	15.60	1250.00
SMLJ7.5A	HDP	SMLJ7.5CA	IDP	8.33	9.21	1	7.5	100	12.9	232.60	16.80	1163.00
SMLJ8.0A	HDR	SMLJ8.0CA	IDR	8.89	9.83	1	8	50	13.6	220.60	17.70	1103.00
SMLJ8.5A	HDT	SMLJ8.5CA	IDT	9.44	10.4	1	8.5	25	14.4	208.40	18.70	1041.50
SMLJ9.0A	HDV	SMLJ9.0CA	IDV	10.0	11.1	1	9	10	15.4	194.80	20.00	974.00
SMLJ10A	HDX	SMLJ10CA	IDX	11.1	12.3	1	10	5	17	176.40	22.10	882.50
SMLJ11A	HDZ	SMLJ11CA	IDZ	12.2	13.5	1	11	5	18.2	164.80	23.70	824.00
SMLJ12A	HEE	SMLJ12CA	IEE	13.3	14.7	1	12	2	19.9	150.60	25.90	754.00
SMLJ13A	HEG	SMLJ13CA	IEG	14.4	15.9	1	13	2	21.5	139.40	28.00	697.50
SMLJ14A	HEK	SMLJ14CA	IEK	15.6	17.2	1	14	2	23.2	129.40	30.20	646.50
SMLJ15A	HEM	SMLJ15CA	IEM	16.7	18.5	1	15	2	24.4	123.00	31.70	615.00
SMLJ16A	HEP	SMLJ16CA	IEP	17.8	19.7	1	16	2	26	115.40	33.80	577.00
SMLJ17A	HER	SMLJ17CA	IER	18.9	20.9	1	17	2	27.6	106.60	35.90	543.50
SMLJ18A	HET	SMLJ18CA	IET	20.0	22.1	1	18	2	29.2	102.80	38.00	513.50
SMLJ20A	HEV	SMLJ20CA	IEV	22.2	24.5	1	20	2	32.4	92.60	42.10	463.00
SMLJ22A	HEX	SMLJ22CA	IEX	24.4	26.9	1	22	2	35.5	84.40	46.20	422.50
SMLJ24A	HEZ	SMLJ24CA	IEZ	26.7	29.5	1	24	2	38.9	77.20	50.60	385.50
SMLJ26A	HFE	SMLJ26CA	IFE	28.9	31.9	1	26	2	42.1	71.20	54.70	356.50
SMLJ28A	HFG	SMLJ28CA	IFG	31.1	34.4	1	28	2	45.4	66.00	59.00	330.50
SMLJ30A	HFK	SMLJ30CA	IFK	33.3	36.8	1	30	2	48.4	62.00	62.90	310.00
SMLJ33A	HFM	SMLJ33CA	IFM	36.7	40.6	1	33	2	53.3	56.20	69.30	281.50
SMLJ36A	HFP	SMLJ36CA	IFP	40	44.2	1	36	2	58.1	51.60	75.50	258.00
SMLJ40A	HFR	SMLJ40CA	IFR	44.4	49.1	1	40	2	64.5	46.40	83.90	232.50
SMLJ43A	HFT	SMLJ43CA	IFT	47.8	52.8	1	43	2	69.4	43.20	90.20	216.00
SMLJ45A	HFV	SMLJ45CA	IFV	50	55.3	1	45	2	72.7	41.20	94.50	206.50
SMLJ48A	HFX	SMLJ48CA	IFX	53.3	58.9	1	48	2	77.4	38.80	100.60	194.00
SMLJ51A	HFZ	SMLJ51CA	IFZ	56.7	62.7	1	51	2	82.4	36.40	107.10	182.00
SMLJ54A	HGE	SMLJ54CA	IGE	60	66.3	1	54	2	87.1	34.40	113.20	172.00
SMLJ58A	HGG	SMLJ58CA	IGG	64.4	71.2	1	58	2	93.6	32.00	121.70	160.50
SMLJ60A	HGK	SMLJ60CA	IGK	66.7	73.7	1	60	2	96.8	31.00	125.80	155.00
SMLJ64A	HGM	SMLJ64CA	IGM	71.1	78.6	1	64	2	103	29.20	133.90	145.50
SMLJ70A	HGP	SMLJ70CA	IGP	77.8	86.0	1	70	2	113	26.60	146.90	132.50
SMLJ75A	HGR	SMLJ75CA	IGR	83.3	92.1	1	75	2	121	24.80	157.30	124.00
SMLJ78A	HGT	SMLJ78CA	IGT	86.7	95.8	1	78	2	126	22.80	163.80	119.00
SMLJ85A	HGV	SMLJ85CA	IGV	94.4	104	1	85	2	137	20.80	178.10	109.50
SMLJ90A	HGX	SMLJ90CA	IGX	100	111	1	90	2	146	20.60	189.80	102.50
SMLJ100A	HGZ	SMLJ100CA	IGZ	111	123	1	100	2	162	18.60	210.60	92.50
SMLJ110A	HHE	SMLJ110CA	IHE	122	135	1	110	2	177	16.80	230.10	84.50
SMLJ120A	HHG	SMLJ120CA	IHG	133	147	1	120	2	193	15.60	250.90	77.50
SMLJ130A	HHH	SMLJ130CA	IHH	144	159	1	130	2	209	14.40	271.70	72.00
SMLJ150A	HHM	SMLJ150CA	IHM	167	185	1	150	2	243	12.40	315.90	61.50
SMLJ160A	HHP	SMLJ160CA	IHP	178	197	1	160	2	259	11.60	336.70	58.00
SMLJ170A	HHR	SMLJ170CA	IHR	189	209	1	170	2	275	11.00	357.50	54.50

**Notes:**

1. Suffix 'A' denotes a 5 % tolerance unidirectional device.
2. Suffix 'CA' denotes a 5 % tolerance bidirectional device.
3. For bidirectional devices with a V<sub>R</sub> of 10 volts or less, the I<sub>R</sub> limit is double.

Specifications are subject to change without notice.

Users should verify actual device performance in their specific applications.

The products described herein and this document are subject to specific legal disclaimers as set forth on the last page of this document, and at [www.bourns.com/docs/legal/disclaimer.pdf](http://www.bourns.com/docs/legal/disclaimer.pdf).

# SMLJ Transient Voltage Suppressor Diode Series



## Product Dimensions

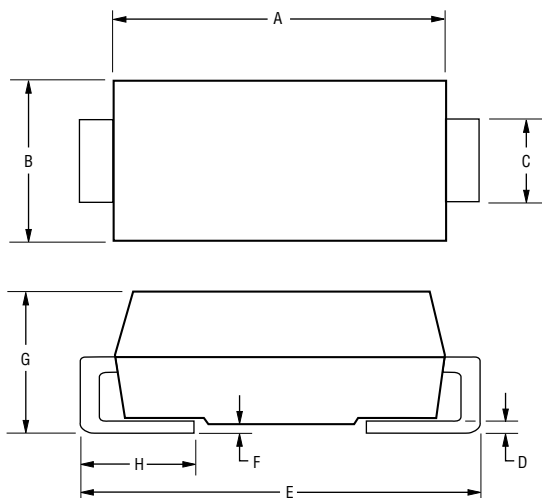

Dimension	SMC (DO-214AB)
A	$\frac{6.60 - 7.11}{(0.260 - 0.280)}$
B	$\frac{5.59 - 6.22}{(0.220 - 0.245)}$
C	$\frac{2.90 - 3.20}{(0.114 - 0.126)}$
D	$\frac{0.15 - 0.31}{(0.006 - 0.012)}$
E	$\frac{7.75 - 8.13}{(0.305 - 0.320)}$
F	$\frac{0.05 - 0.20}{(0.002 - 0.008)}$
G	$\frac{2.00 - 2.62}{(0.079 - 0.103)}$
H	$\frac{0.76 - 1.52}{(0.030 - 0.060)}$

DIMENSIONS:  $\frac{\text{MM}}{\text{(INCHES)}}$

## Recommended Footprint

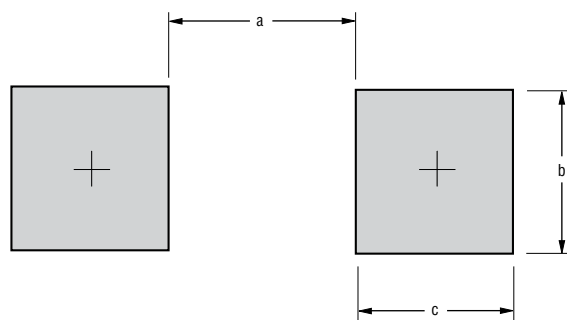

Dimension	SMC (DO-214AB)
a (Max.)	$\frac{4.69}{(0.185)}$
b (Min.)	$\frac{3.07}{(0.121)}$
c (Min.)	$\frac{1.52}{(0.060)}$

DIMENSIONS:  $\frac{\text{MM}}{\text{(INCHES)}}$

## Physical Specifications

Case ..... Molded plastic per UL Class 94V-0  
 Polarity.....Cathode band indicates unidirectional device  
 No cathode band indicates bidirectional device

Specifications are subject to change without notice.

Users should verify actual device performance in their specific applications.

The products described herein and this document are subject to specific legal disclaimers as set forth on the last page of this document, and at [www.bourns.com/docs/legal/disclaimer.pdf](http://www.bourns.com/docs/legal/disclaimer.pdf).

# SMLJ Transient Voltage Suppressor Diode Series



## Rating & Characteristic Curves

### Pulse Derating Curve

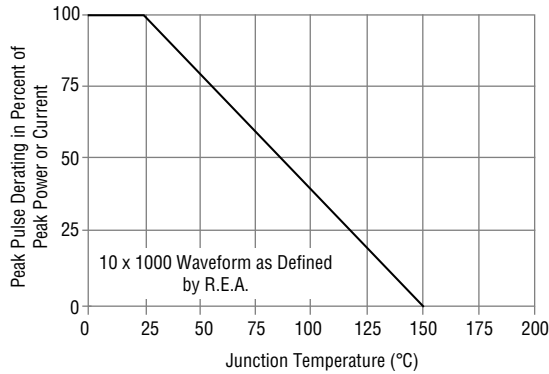

### Maximum Non-Repetitive Surge Current

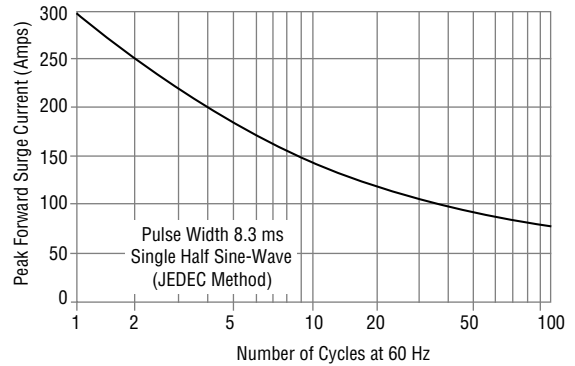

### Pulse Waveform

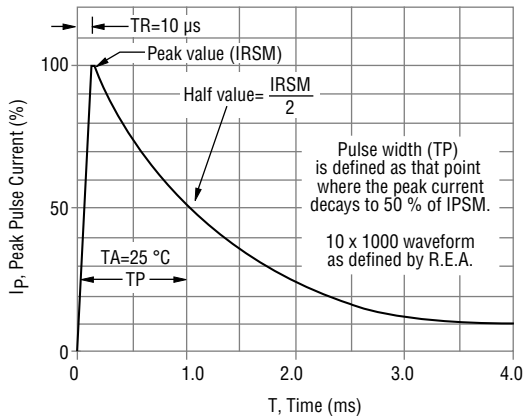

### Typical Junction Capacitance

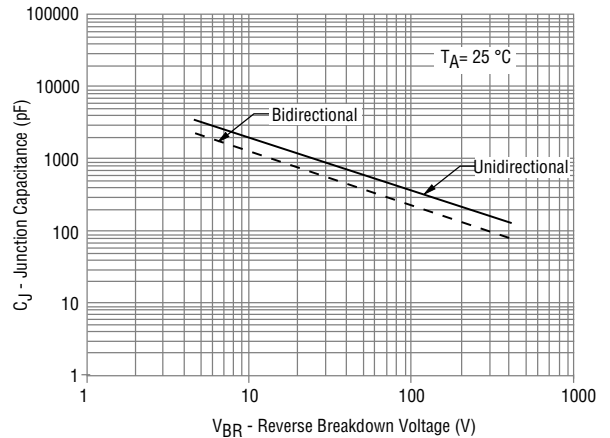

### Pulse Rating Curve

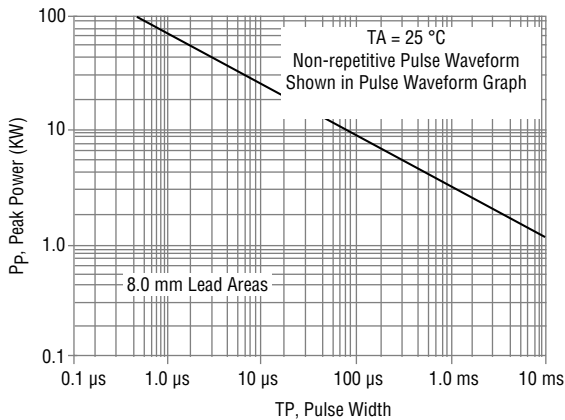

### Steady State Power Derating Curve

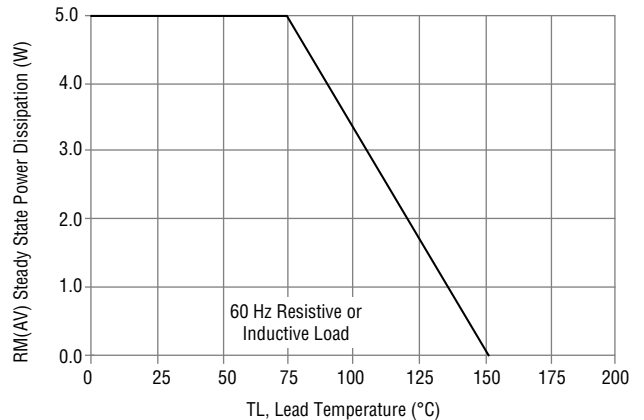

Specifications are subject to change without notice.

Users should verify actual device performance in their specific applications.

The products described herein and this document are subject to specific legal disclaimers as set forth on the last page of this document, and at [www.bourns.com/docs/legal/disclaimer.pdf](http://www.bourns.com/docs/legal/disclaimer.pdf).

# SMLJ Transient Voltage Suppressor Diode Series

**BOURNS®**

## Packaging Information

The product will be dispensed in tape and reel format (see diagram below).

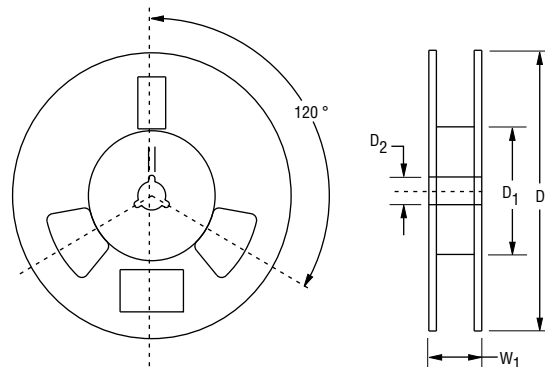
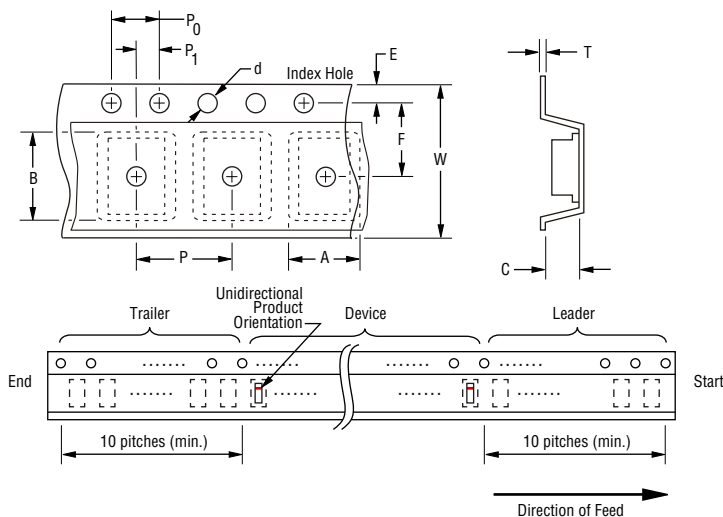

DIMENSIONS:  $\frac{\text{MM}}{\text{(INCHES)}}$

Devices are packed in accordance with EIA standard RS-481-A and specifications shown here.

Item	Symbol	SMC (DO-214AB)	
		7 Inch Reel	13 Inch Reel
Carrier Width	A	$\frac{6.0 \pm 2.0}{(0.236 - 0.079)}$	
Carrier Length	B	$\frac{8.3 \pm 0.20}{(0.327 \pm 0.008)}$	
Carrier Depth	C	$\frac{2.5 \pm 0.20}{(0.098 \pm 0.008)}$	
Sprocket Hole	d	$\frac{1.50 \pm 0.10}{(0.059 \pm 0.004)}$	
Reel Outside Diameter	D	$\frac{178}{(7.008)}$	$\frac{330}{(12.992)}$
Reel Inner Diameter	D <sub>1</sub>	$\frac{50.0}{(1.969)}$ MIN.	
Feed Hole Diameter	D <sub>2</sub>	$\frac{13.0 + 0.50/-0.20}{(0.512 + 0.020/-0.008)}$	
Sprocket Hole Position	E	$\frac{1.75 \pm 0.10}{(0.069 \pm 0.004)}$	
Punch Hole Position	F	$\frac{7.50 \pm 0.10}{(0.295 \pm 0.004)}$	
Punch Hole Pitch	P	$\frac{8.00 \pm 0.10}{(0.315 \pm 0.004)}$	
Sprocket Hole Pitch	P <sub>0</sub>	$\frac{4.00 \pm 0.10}{(0.157 \pm 0.004)}$	
Embossment Center	P <sub>1</sub>	$\frac{2.00 \pm 0.10}{(0.079 \pm 0.004)}$	
Overall Tape Thickness	T	$\frac{0.30 \pm 0.10}{(0.012 \pm 0.004)}$	
Tape Width	W	$\frac{16.00 \pm 0.30}{(0.630 \pm 0.012)}$	
Reel Width	W <sub>1</sub>	$\frac{22.4}{(0.882)}$ MAX.	
Quantity per Reel	--	500	3,000

REV. 02/21

Specifications are subject to change without notice.

Users should verify actual device performance in their specific applications.

The products described herein and this document are subject to specific legal disclaimers as set forth on the last page of this document, and at [www.bourns.com/docs/legal/disclaimer.pdf](http://www.bourns.com/docs/legal/disclaimer.pdf).

This legal disclaimer applies to purchasers and users of Bourns® products manufactured by or on behalf of Bourns, Inc. and its affiliates (collectively, "Bourns").

Unless otherwise expressly indicated in writing, Bourns® products and data sheets relating thereto are subject to change without notice. Users should check for and obtain the latest relevant information and verify that such information is current and complete before placing orders for Bourns® products.

The characteristics and parameters of a Bourns® product set forth in its data sheet are based on laboratory conditions, and statements regarding the suitability of products for certain types of applications are based on Bourns' knowledge of typical requirements in generic applications. The characteristics and parameters of a Bourns® product in a user application may vary from the data sheet characteristics and parameters due to (i) the combination of the Bourns® product with other components in the user's application, or (ii) the environment of the user application itself. The characteristics and parameters of a Bourns® product also can and do vary in different applications and actual performance may vary over time. Users should always verify the actual performance of the Bourns® product in their specific devices and applications, and make their own independent judgments regarding the amount of additional test margin to design into their device or application to compensate for differences between laboratory and real world conditions.

Unless Bourns has explicitly designated an individual Bourns® product as meeting the requirements of a particular industry standard (e.g., ISO/TS 16949) or a particular qualification (e.g., UL listed or recognized), Bourns is not responsible for any failure of an individual Bourns® product to meet the requirements of such industry standard or particular qualification. Users of Bourns® products are responsible for ensuring compliance with safety-related requirements and standards applicable to their devices or applications.

Bourns® products are not recommended, authorized or intended for use in nuclear, lifesaving, life-critical or life-sustaining applications, nor in any other applications where failure or malfunction may result in personal injury, death, or severe property or environmental damage. Unless expressly and specifically approved in writing by two authorized Bourns representatives on a case-by-case basis, use of any Bourns® products in such unauthorized applications might not be safe and thus is at the user's sole risk. Life-critical applications include devices identified by the U.S. Food and Drug Administration as Class III devices and generally equivalent classifications outside of the United States.

Bourns expressly identifies those Bourns® standard products that are suitable for use in automotive applications on such products' data sheets in the section entitled "Applications." Unless expressly and specifically approved in writing by two authorized Bourns representatives on a case-by-case basis, use of any other Bourns® standard products in an automotive application might not be safe and thus is not recommended, authorized or intended and is at the user's sole risk. If Bourns expressly identifies a sub-category of automotive application in the data sheet for its standard products (such as infotainment or lighting), such identification means that Bourns has reviewed its standard product and has determined that if such Bourns® standard product is considered for potential use in automotive applications, it should only be used in such sub-category of automotive applications. Any reference to Bourns® standard product in the data sheet as compliant with the AEC-Q standard or "automotive grade" does not by itself mean that Bourns has approved such product for use in an automotive application.

Bourns® standard products are not tested to comply with United States Federal Aviation Administration standards generally or any other generally equivalent governmental organization standard applicable to products designed or manufactured for use in aircraft or space applications. Bourns expressly identifies Bourns® standard products that are suitable for use in aircraft or space applications on such products' data sheets in the section entitled "Applications." Unless expressly and specifically approved in writing by two authorized Bourns representatives on a case-by-case basis, use of any other Bourns® standard product in an aircraft or space application might not be safe and thus is not recommended, authorized or intended and is at the user's sole risk.

The use and level of testing applicable to Bourns® custom products shall be negotiated on a case-by-case basis by Bourns and the user for which such Bourns® custom products are specially designed. Absent a written agreement between Bourns and the user regarding the use and level of such testing, the above provisions applicable to Bourns® standard products shall also apply to such Bourns® custom products.

Users shall not sell, transfer, export or re-export any Bourns® products or technology for use in activities which involve the design, development, production, use or stockpiling of nuclear, chemical or biological weapons or missiles, nor shall they use Bourns® products or technology in any facility which engages in activities relating to such devices. The foregoing restrictions apply to all uses and applications that violate national or international prohibitions, including embargos or international regulations. Further, Bourns® products and Bourns technology and technical data may not under any circumstance be exported or re-exported to countries subject to international sanctions or embargoes. Bourns® products may not, without prior authorization from Bourns and/or the U.S. Government, be resold, transferred, or re-exported to any party not eligible to receive U.S. commodities, software, and technical data.

To the maximum extent permitted by applicable law, Bourns disclaims (i) any and all liability for special, punitive, consequential, incidental or indirect damages or lost revenues or lost profits, and (ii) any and all implied warranties, including implied warranties of fitness for particular purpose, non-infringement and merchantability.

*For your convenience, copies of this Legal Disclaimer Notice with German, Spanish, Japanese, Traditional Chinese and Simplified Chinese bilingual versions are available at:*

*Web Page:* <http://www.bourns.com/legal/disclaimers-terms-and-policies>

*PDF:* <http://www.bourns.com/docs/Legal/disclaimer.pdf>

单击下面可查看定价，库存，交付和生命周期等信息

[>>Bourns\(伯恩斯\)](#)