

Bridgelux® V6 Array

Product Data Sheet DS40



BXPE-27x0400 | 30x0400 | 35x0400 | 40x0400 | 50x0400

Introduction

V Series

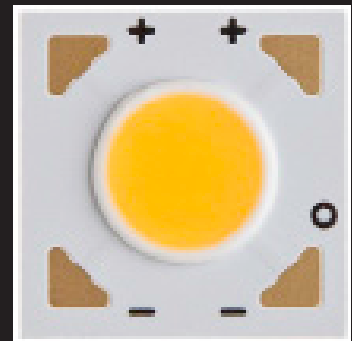

The V Series LED Array products deliver high quality light in a compact and cost-effective solid-state lighting package. These Chip-on-Board (CoB) arrays can be efficiently driven at twice the nominal drive current, enabling design flexibility not previously possible. This high flux density light source is designed to support a wide range of high quality, low cost directional luminaires and replacement lamps for commercial and residential applications.

The V6 LED Array is available in a variety of electrical, CCT and CRI combinations providing substantial design flexibility and energy efficiencies.

Lighting system designs incorporating these LED Arrays deliver comparable performance to 7-13 Watt compact fluorescent and 25 - 50 Watt incandescent and halogen based luminaires, delivering increased system level efficacy and longer service life. Typical applications include, but are not limited to, replacement lamps, task, accent, spot, track, down light, wide area, security, and wall pack.

Features

- Efficacy of 130 lm/W typical
- Compact high flux density light source
- Uniform high quality illumination
- Minimum 70, 80 and 90 CRI options
- Streamlined thermal path
- Energy Star / ANSI compliant color binning structure with 3SDCM and 4SDCM options
- More energy efficient than incandescent, halogen and fluorescent lamps
- Low voltage DC operation
- Instant light with unlimited dimming

Benefits

- Enhanced optical control
- Clean white light without pixilation
- High quality true color reproduction
- Significantly reduced thermal resistance and increased operating temperatures
- Uniform consistent white light
- Lower operating costs
- Easy to use with daylight and motion detectors to enable increased energy savings
- Reduced maintenance costs
- Environmentally friendly, no disposal issue



Contents

Product Feature Map	2
Product Nomenclature	2
Product Selection Guide	3
Performance at Commonly Used Drive Currents	4
Electrical Characteristics	7
Absolute Maximum Ratings	8
Performance Curves	9
Typical Radiation Pattern	13
Typical Color Spectrum	14
Mechanical Dimensions	15
Color Binning Information	16
Packaging and Labeling	17
Design Resources	19
Precautions	19
Disclaimers	19
About Bridgelux	20

Product Selection Guide

The following product configurations are available:

Table 1: Selection Guide, Pulsed Measurement Data ($T_j = T_c = 25^\circ\text{C}$)

Part Number	Nominal CCT ¹ (K)	CRI ²	Nominal Drive Current ³ (mA)	Typical Pulsed Flux ^{4,5,6} $T_c = 25^\circ\text{C}$ (lm)	Minimum Pulsed Flux ^{6,7} $T_c = 25^\circ\text{C}$ (lm)	Typical V_f (V)	Typical Power (W)	Typical Efficacy (lm/W)
BXRE-27E0400-A-2x	2700	80	175	381	362	18.0	3.2	121
BXRE-27E0400-B-2x	2700	80	350	381	362	9.0	3.2	121
BXRE-27G0400-A-2x	2700	90	175	320	283	18.0	3.2	102
BXRE-27G0400-B-2x	2700	90	350	320	283	9.0	3.2	102
BXRE-30E0400-A-2x	3000	80	175	400	372	18.0	3.2	127
BXRE-30E0400-B-2x	3000	80	350	400	372	9.0	3.2	127
BXRE-30G0400-A-2x	3000	90	175	334	309	18.0	3.2	106
BXRE-30G0400-B-2x	3000	90	350	334	309	9.0	3.2	106
BXRE-35E0400-A-2x	3500	80	175	403	371	18.0	3.2	128
BXRE-35E0400-B-2x	3500	80	350	403	371	9.0	3.2	128
BXRE-35G0400-A-2x	3500	90	175	344	310	18.0	3.2	109
BXRE-35G0400-B-2x	3500	90	350	344	310	9.0	3.2	109
BXRE-40E0400-A-2x	4000	80	175	426	411	18.0	3.2	135
BXRE-40E0400-B-2x	4000	80	350	426	411	9.0	3.2	135
BXRE-50C0400-A-24	5000	70	175	439	403	18.0	3.2	139
BXRE-50C0400-B-24	5000	70	350	439	403	9.0	3.2	139
BXRE-50E0400-A-24	5000	80	175	416	400	18.0	3.2	132
BXRE-50E0400-B-24	5000	80	350	416	400	9.0	3.2	132

Table 2: Selection Guide, Stabilized DC Performance ($T_c = 85^\circ\text{C}$)^{8,9}

Part Number	Nominal CCT ¹ (K)	CRI ²	Nominal Drive Current ³ (mA)	Typical DC Flux $T_c = 85^\circ\text{C}$ (lm)	Minimum DC Flux ¹⁰ $T_c = 85^\circ\text{C}$ (lm)	Typical V_f (V)	Typical Power (W)	Typical Efficacy (lm/W)
BXRE-27E0400-A-2x	2700	80	175	337	320	17.6	3.1	110
BXRE-27E0400-B-2x	2700	80	350	337	320	8.8	3.1	110
BXRE-27G0400-A-2x	2700	90	175	283	250	17.6	3.1	92
BXRE-27G0400-B-2x	2700	90	350	283	250	8.8	3.1	92
BXRE-30E0400-A-2x	3000	80	175	354	329	17.6	3.1	115
BXRE-30E0400-B-2x	3000	80	350	354	329	8.8	3.1	115
BXRE-30G0400-A-2x	3000	90	175	295	273	17.6	3.1	96
BXRE-30G0400-B-2x	3000	90	350	295	273	8.8	3.1	96
BXRE-35E0400-A-2x	3500	80	175	356	328	17.6	3.1	116
BXRE-35E0400-B-2x	3500	80	350	356	328	8.8	3.1	116
BXRE-35G0400-A-2x	3500	90	175	304	274	17.6	3.1	99
BXRE-35G0400-B-2x	3500	90	350	304	274	8.8	3.1	99
BXRE-40E0400-A-2x	4000	80	175	380	367	17.6	3.1	124
BXRE-40E0400-B-2x	4000	80	350	380	367	8.8	3.1	124
BXRE-50C0400-A-24	5000	70	175	381	349	17.6	3.1	124
BXRE-50C0400-B-24	5000	70	350	381	349	8.8	3.1	124
BXRE-50E0400-A-24	5000	80	175	361	347	17.6	3.1	118
BXRE-50E0400-B-24	5000	80	350	361	347	8.8	3.1	118

Notes for Tables 1 & 2:

- Nominal CCT as defined by ANSI C78.377-2011.
- CRI Values are minimums. Minimum Rg value for 80 CRI products is 0, the minimum Rg values for 90 CRI products is 50.
- Drive current is referred to as nominal drive current.
- Products tested under pulsed condition (10ms pulse width) at nominal test current where T_j (junction temperature) = T_c (case temperature) = 25°C .
- Typical performance values are provided as a reference only and are not a guarantee of performance.
- Bridgelux maintains a $\pm 7\%$ tolerance on flux measurements.
- Minimum flux values at the nominal test current are guaranteed by 100% test.
- Typical stabilized DC performance values are provided as reference only and are not a guarantee of performance.
- Typical performance is estimated based on operation under DC (direct current) with LED array mounted onto a heat sink with thermal interface material and the case temperature maintained at 85°C . Based on Bridgelux test setup, values may vary depending on the thermal design of the luminaire and/or the exposed environment to which the product is subjected.
- Minimum flux values at elevated temperatures are provided for reference only and are not guaranteed by 100% production testing. Based on Bridgelux test setup, values may vary depending on the thermal design of the luminaire and/or the exposed environment to which the product is subjected.

Performance at Commonly Used Drive Currents

V Series LED arrays are tested to the specifications shown using the nominal drive currents in Table 1. V Series may also be driven at other drive currents dependent on specific application design requirements. The performance at any drive current can be derived from the current vs. voltage characteristics shown in Figures 1 & 2 and the flux vs. current characteristics shown in Figures 3 & 4. The performance at commonly used drive currents is summarized in Table 3.

Table 3: Product Performance at Commonly Used Drive Currents

Part Number	CRI	Drive Current ¹ (mA)	Typical V_f $T_c = 25^\circ\text{C}$ (V)	Typical Power $T_c = 25^\circ\text{C}$ (W)	Typical Flux ² $T_c = 25^\circ\text{C}$ (lm)	Typical Flux ³ $T_c = 85^\circ\text{C}$ (lm)	Typical Efficacy $T_c = 25^\circ\text{C}$ (lm/W)
BXRE-27E0400-A-2x	80	175	18.0	3.2	381	337	121
		250	18.6	4.7	521	461	112
		350	19.4	6.8	689	609	101
BXRE-27E0400-B-2x	80	175	8.6	1.5	203	180	135
		350	9.0	3.2	381	337	121
		500	9.3	4.7	516	457	111
		700	9.7	6.8	668	591	98
BXRE-27G0400-A-2x	90	175	18.0	3.2	320	283	102
		250	18.6	4.7	437	387	94
		350	19.4	6.8	578	512	85
BXRE-27G0400-B-2x	90	175	8.6	1.5	170	151	113
		350	9.0	3.2	320	283	102
		500	9.3	4.7	434	384	93
		700	9.7	6.8	561	496	83
BXRE-30E0400-A-2x	80	175	18.0	3.2	400	354	127
		250	18.6	4.7	547	483	118
		350	19.4	6.8	723	639	106
BXRE-30E0400-B-2x	80	175	8.6	1.5	213	188	142
		350	9.0	3.2	400	354	127
		500	9.3	4.7	542	479	117
		700	9.7	6.8	701	620	103

Notes for Table 3:

1. Alternate drive currents in Table 3 are provided for reference only and are not a guarantee of performance.
2. Bridgelux maintains a $\pm 7\%$ tolerance on flux measurements.
3. Typical stabilized DC performance values are provided as reference only and are not a guarantee of performance.

Performance at Commonly Used Drive Currents

Table 3: Product Performance at Commonly Used Drive Currents (Continued)

Part Number	CRI	Drive Current ¹ (mA)	Typical V _f T _c = 25°C (V)	Typical Power T _c = 25°C (W)	Typical Flux ² T _c = 25°C (lm)	Typical Flux ³ T _c = 85°C (lm)	Typical Efficacy T _c = 25°C (lm/W)
BXRE-30G0400-A-2x	90	175	18.0	3.2	334	295	106
		250	18.6	4.7	456	404	98
		350	19.4	6.8	604	534	89
BXRE-30G0400-B-2x	90	175	8.6	1.5	178	157	118
		350	9.0	3.2	334	295	106
		500	9.3	4.7	453	400	97
		700	9.7	6.8	586	518	86
BXRE-35E0400-A-2x	80	175	18.0	3.2	403	356	128
		250	18.6	4.7	551	487	118
		350	19.4	6.8	728	644	107
BXRE-35E0400-B-2x	80	175	8.6	1.5	215	190	143
		350	9.0	3.2	403	356	128
		500	9.3	4.7	546	483	117
		700	9.7	6.8	707	625	104
BXRE-35G0400-A-2x	90	175	18.0	3.2	344	304	109
		250	18.6	4.7	470	416	101
		350	19.4	6.8	622	550	92
BXRE-35G0400-B-2x	90	175	8.6	1.5	183	162	122
		350	9.0	3.2	344	304	109
		500	9.3	4.7	466	412	100
		700	9.7	6.8	603	533	89

Notes for Table 3:

1. Alternate drive currents in Table 3 are provided for reference only and are not a guarantee of performance.
2. Bridgelux maintains a ± 7% tolerance on flux measurements.
3. Typical stabilized DC performance values are provided as reference only and are not a guarantee of performance.

Performance at Commonly Used Drive Currents

Table 3: Product Performance at Commonly Used Drive Currents (Continued)

Part Number	CRI	Drive Current ¹ (mA)	Typical V_f $T_c = 25^\circ\text{C}$ (V)	Typical Power $T_c = 25^\circ\text{C}$ (W)	Typical Flux ² $T_c = 25^\circ\text{C}$ (lm)	Typical Flux ³ $T_c = 85^\circ\text{C}$ (lm)	Typical Efficacy $T_c = 25^\circ\text{C}$ (lm/W)
BXRE-40E0400-A-2x	80	175	18.0	3.2	426	380	135
		250	18.6	4.7	582	519	125
		350	19.4	6.8	770	687	113
BXRE-40E0400-B-2x	80	175	8.6	1.5	227	203	151
		350	9.0	3.2	426	380	135
		500	9.3	4.7	577	515	124
		700	9.7	6.8	747	667	110
BXRE-50C0400-A-24	70	175	18.0	3.2	439	381	139
		250	18.6	4.7	600	520	129
		350	19.4	6.8	794	688	117
BXRE-50C0400-B-24	70	175	8.6	1.5	234	203	155
		350	9.0	3.2	439	381	139
		500	9.3	4.7	595	516	128
		700	9.7	6.8	770	667	113
BXRE-50E0400-A-24	80	175	18.0	3.2	416	361	132
		250	18.6	4.7	568	493	122
		350	19.4	6.8	752	652	111
BXRE-50E0400-B-24	80	175	8.6	1.5	222	192	147
		350	9.0	3.2	416	361	132
		500	9.3	4.7	564	489	121
		700	9.7	6.8	729	632	107

Notes for Table 3:

1. Alternate drive currents in Table 3 are provided for reference only and are not a guarantee of performance.
2. Bridgelux maintains a $\pm 7\%$ tolerance on flux measurements.
3. Typical stabilized DC performance values are provided as reference only and are not a guarantee of performance.

Electrical Characteristics

Table 4: Electrical Characteristics

Part Number	Drive Current (mA)	Forward Voltage Pulsed, $T_c = 25^\circ\text{C}$ (V) ^{1,2,3}			Typical Coefficient of Forward Voltage ⁴ V_f/T (mV/ $^\circ\text{C}$)	Typical Thermal Resistance Junction to Case ^{5,6} R_{j-c} (C/W)	Driver Selection Voltages ⁷ (V)	
		Minimum	Typical	Maximum			Vf Min. Hot $T_c = 105^\circ\text{C}$ (V)	Vf Max. Cold $T_c = -40^\circ\text{C}$ (V)
BXRE-xxx0400-A-2x	175	16.7	18.0	19.3	-7	1.25	16.1	19.8
	350	17.8	19.4	20.8	-7	1.72	17.2	21.3
BXRE-xxx0400-B-2x	350	8.3	9.0	9.7	-4	1.25	8.0	10.0
	700	8.9	9.8	10.5	-4	1.72	8.6	10.8

Notes for Table 4:

1. Parts are tested in pulsed conditions, $T_c = 25^\circ\text{C}$. Pulse width is 10ms.
2. Voltage minimum and maximum are provided for reference only and are not a guarantee of performance.
3. Bridgelux maintains a tester tolerance of $\pm 0.10\text{V}$ on forward voltage measurements.
4. Typical coefficient of forward voltage tolerance is $\pm 0.1\text{mV}$ for nominal current.
5. Thermal resistance values are based from test data of a 3000K 80 CRI product.
6. Thermal resistance value was calculated using total electrical input power; optical power was not subtracted from input power. The thermal interface material used during testing is not included in the thermal resistance value.
7. Vf min hot and max cold values are provided as reference only and are not guaranteed by test. These values are provided to aid in driver design and selection over the operating range of the product.

Absolute Maximum Ratings

Table 5: Maximum Ratings

Parameter	Maximum Rating	
	BXRE-xxx0400-A-2x	BXRE-xxx0400-B-2x
LED Junction Temperature (T_j)	150°C	
Storage Temperature	-40°C to +105°C	
Operating Case Temperature ¹ (T_c)	105°C	
Soldering Temperature ²	350°C or lower for a maximum of 10 seconds	
	BXRE-xxx0400-A-2x	BXRE-xxx0400-B-2x
Maximum Drive Current ^{3,4,5}	350 mA	700 mA
Maximum Peak Pulsed Drive Current ⁶	500 mA	1000 mA
Maximum Reverse Voltage ⁷	-30 V	-15 V

Notes for Table 5:

1. For IEC 62717 requirement, please consult your Bridgelux sales representative.
2. Refer to Bridgelux Application Note AN41: Assembly Considerations for Bridgelux V Series LED Arrays.
3. DC Forward Current for LM-80 is the maximum drive current for which LM-80 data is currently available.
4. Lumen maintenance (L70) and lifetime predictions are valid for drive current and case temperature conditions used for LM-80 testing as included in the applicable LM-80 test report for these arrays. Contact your Bridgelux sales representatives for LM-80 report.
5. Arrays may be driven at higher currents however lumen maintenance may be reduced.
6. Bridgelux recommends a maximum duty cycle of 10% and pulse width of 20 ms when operating LED Arrays at maximum peak pulsed current specified. Maximum peak pulsed currents indicate values where LED Arrays can be driven without catastrophic failures.
7. Light emitting diodes are not designed to be driven in reverse voltage and will not produce light under this condition. Maximum rating provided for reference only.

Performance Curves

Figure 1: Drive Current vs. Voltage ($T_j = T_c = 25^\circ\text{C}$) - BXRE-xxx0400-A-2x

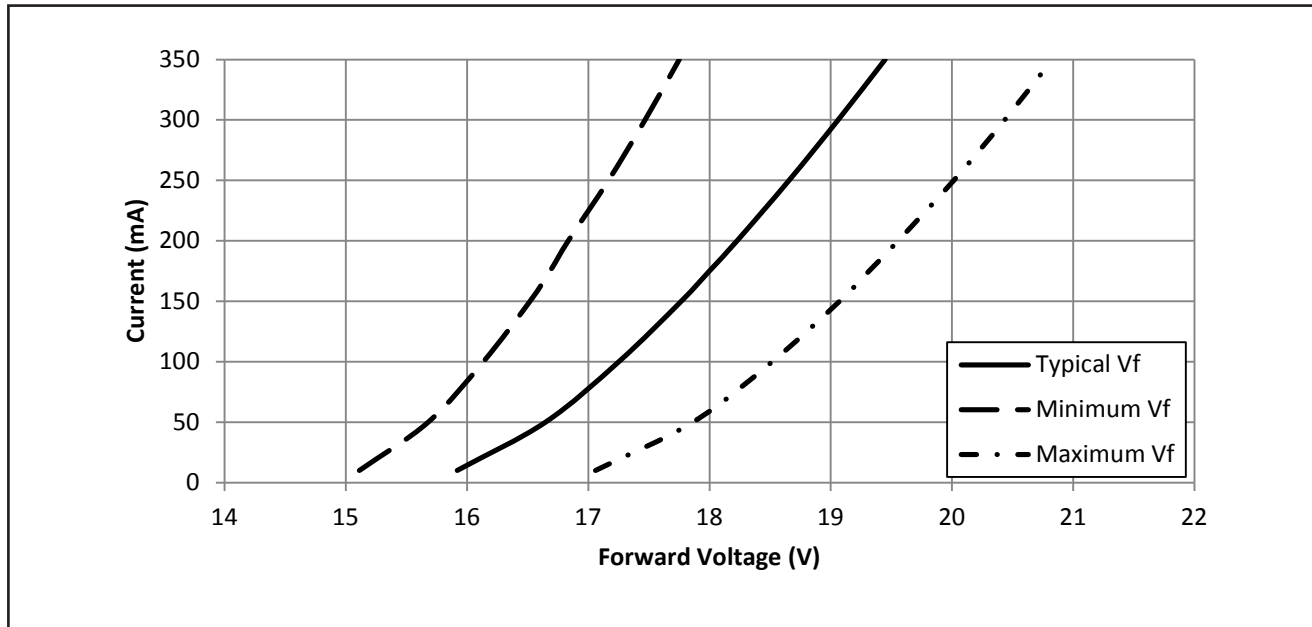
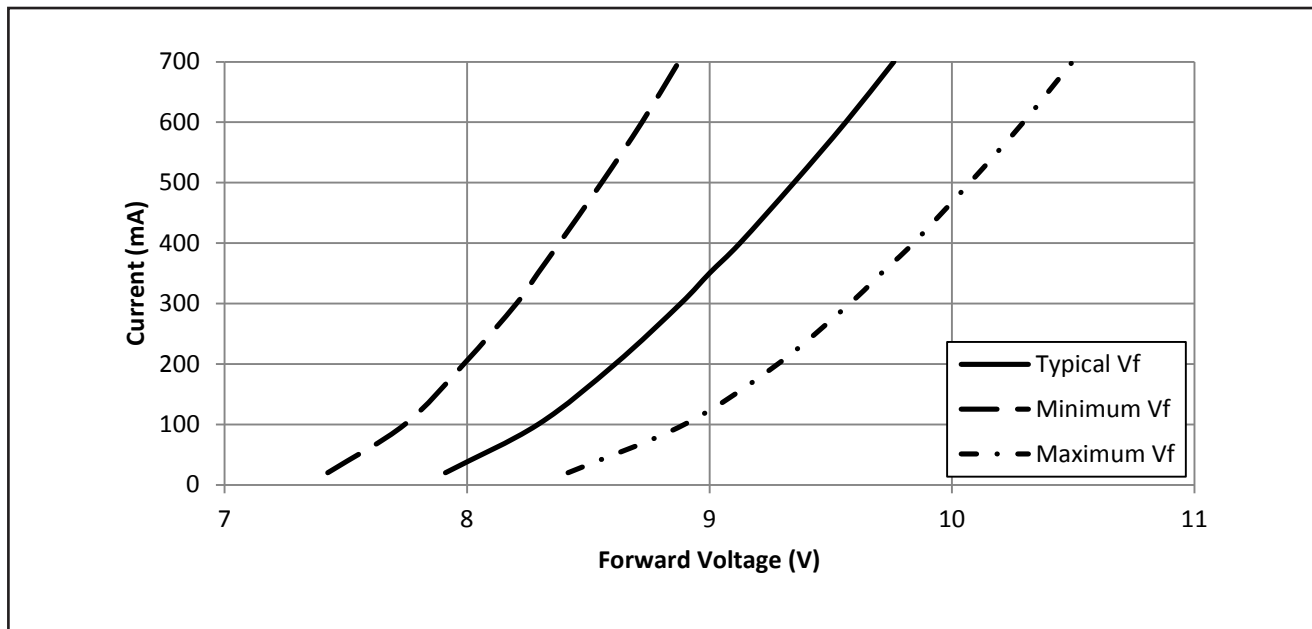

Figure 2: Drive Current vs. Voltage ($T_j = T_c = 25^\circ\text{C}$) - BXRE-xxx0400-B-2x



Performance Curves

Figure 3: Typical Relative Luminous Flux vs. Current - BXRE-xxx0400-A-2x

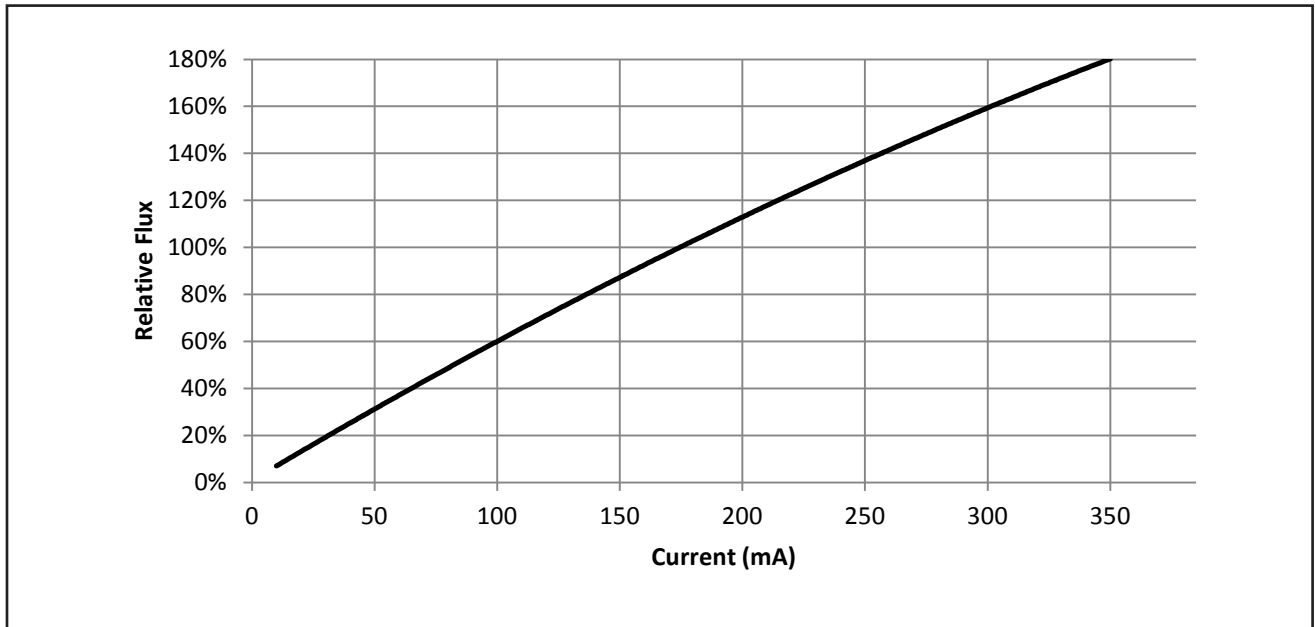
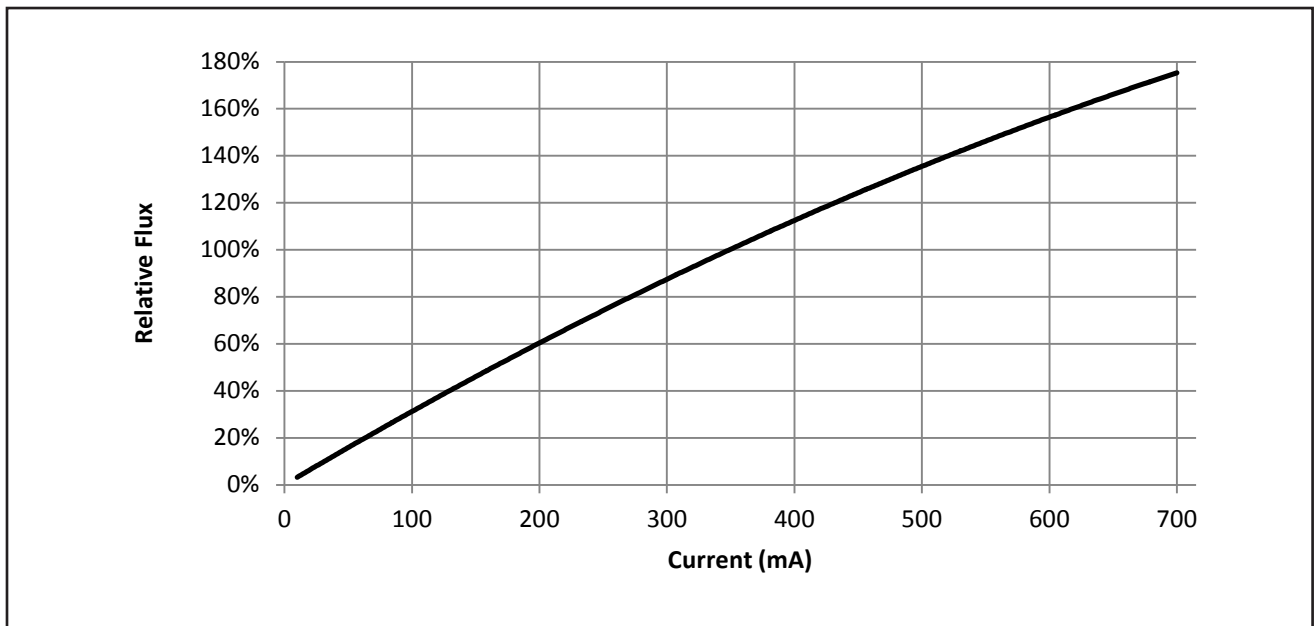

Figure 4: Typical Relative Luminous Flux vs. Current - BXRE-xxx0400-B-2x



Performance Curves

Figure 5: Typical DC Flux vs. Case Temperature

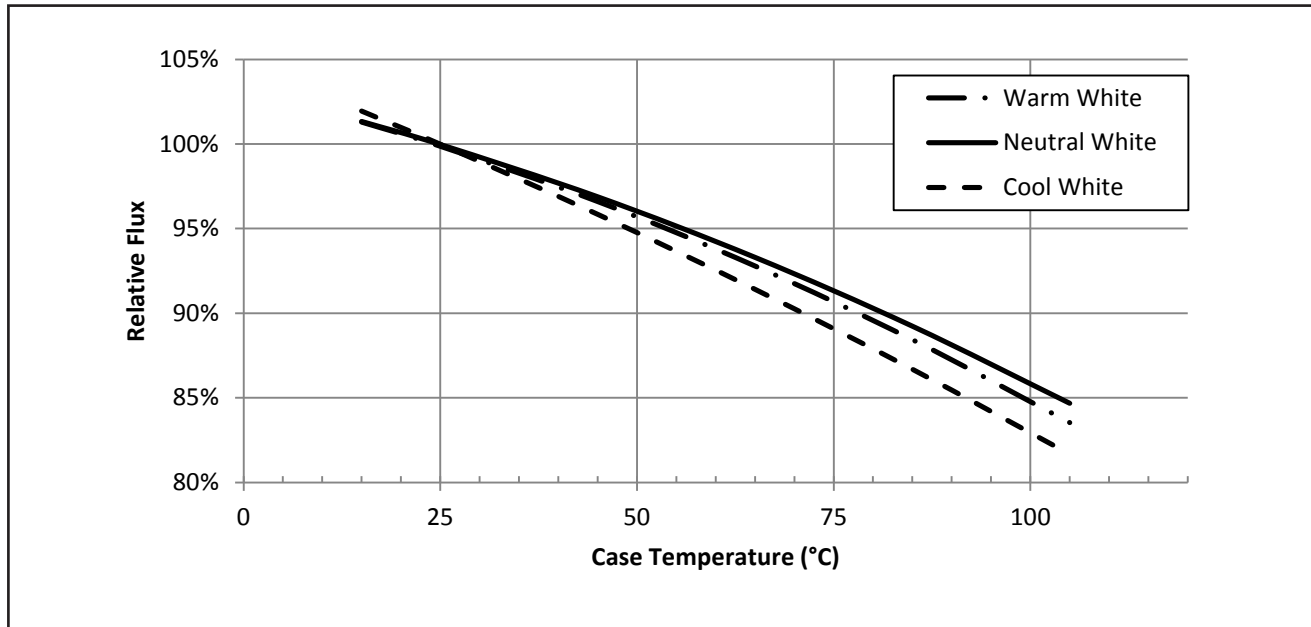
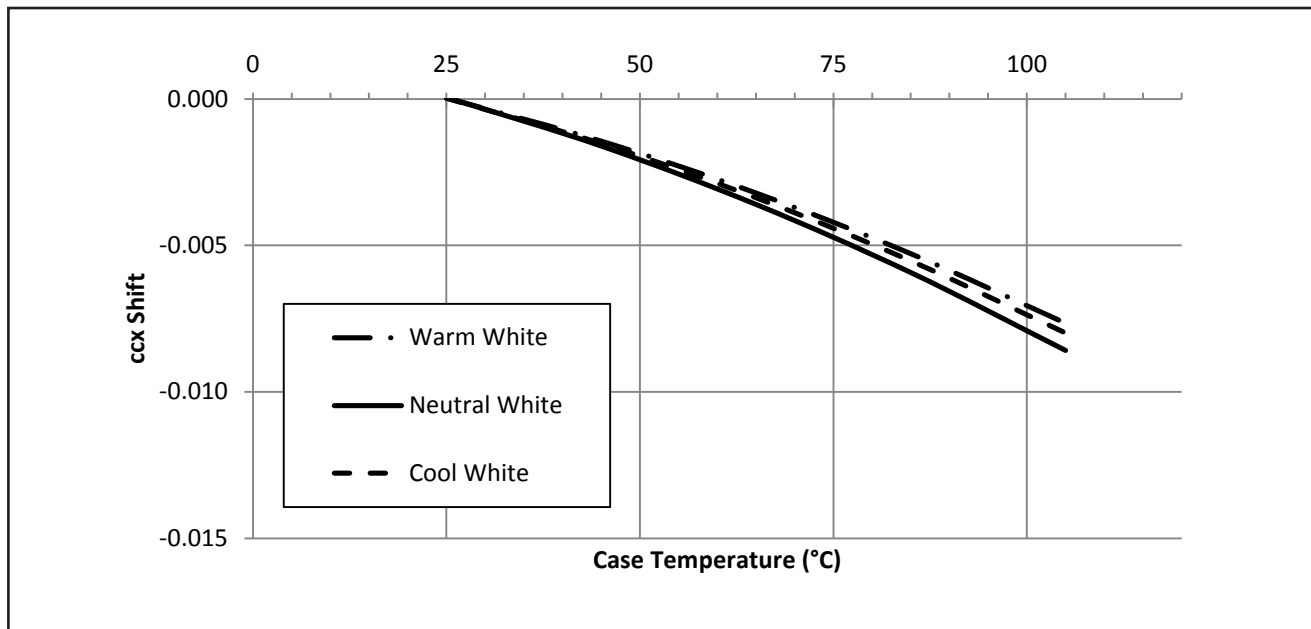

Figure 6: Typical DC ccx Shift vs. Case Temperature



Notes for Figure 5-6:

1. Characteristics shown for warm white based on 3000K and 80 CRI.
2. Characteristics shown for neutral white based on 4000K and 80 CRI.
3. Characteristics shown for cool white based on 5000K and 70 CRI.
4. For other color SKUs, the shift in color will vary. Please contact your Bridgelux Sales Representative for more information.

Performance Curves

Figure 7: Typical DC ccy Shift vs. Case Temperature

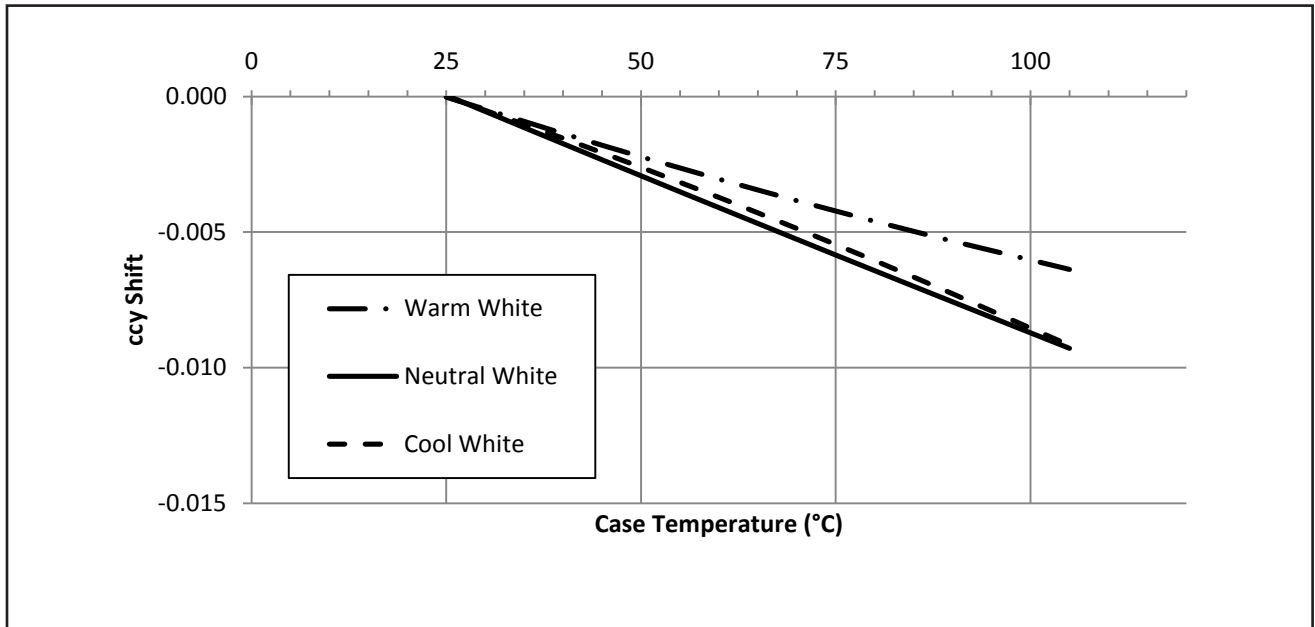

Notes for Figure 7:

1. Characteristics shown for warm white based on 3000K and 80 CRI.
2. Characteristics shown for neutral white based on 4000K and 80 CRI.
3. Characteristics shown for cool white based on 5000K and 70 CRI.
4. For other color SKUs, the shift in color will vary. Please contact your Bridgelux Sales Representative for more information.

Typical Radiation Pattern

Figure 8: Typical Spatial Radiation Pattern

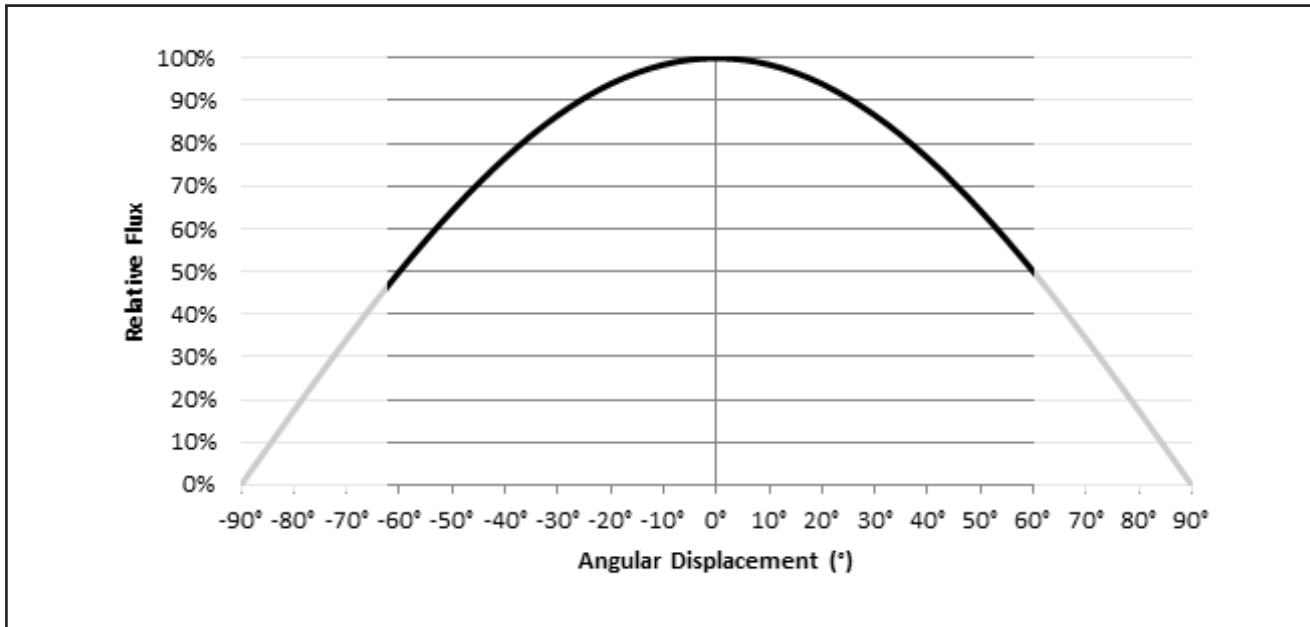

Notes for Figure 8:

1. Typical viewing angle is 120°.
2. The viewing angle is defined as the off axis angle from the centerline where iv is ½ of the peak value.

Figure 9: Typical Polar Radiation Pattern

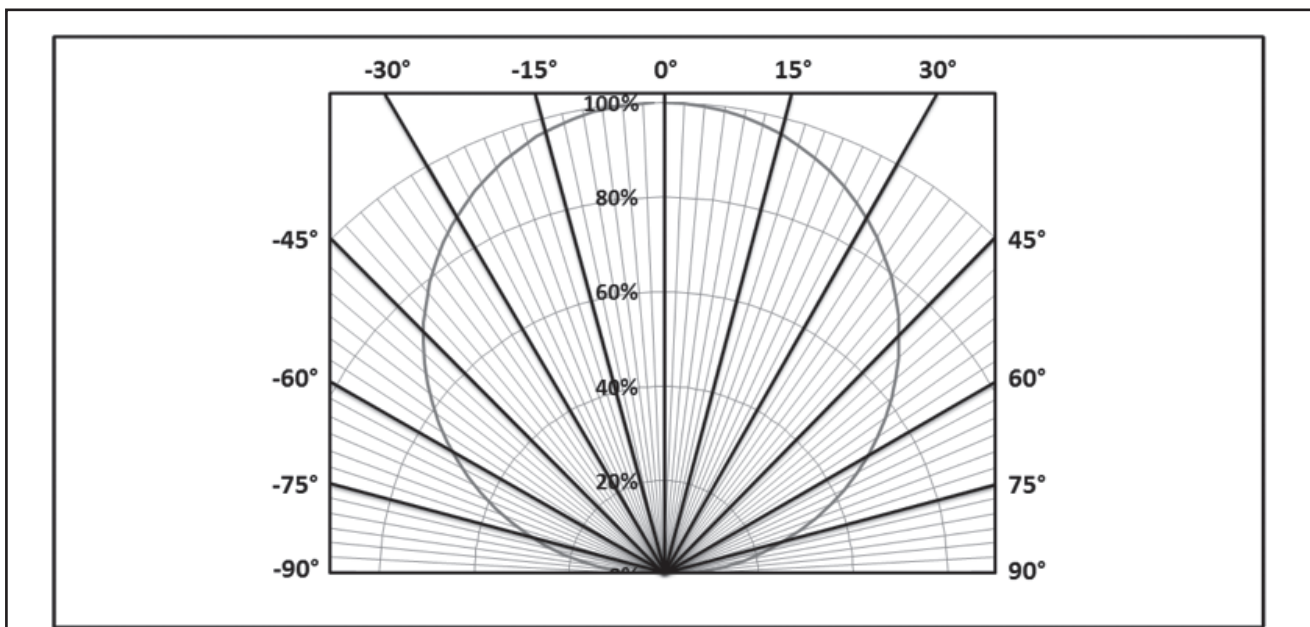

Typical Color Spectrum

Figure 10: Typical Color Spectrum

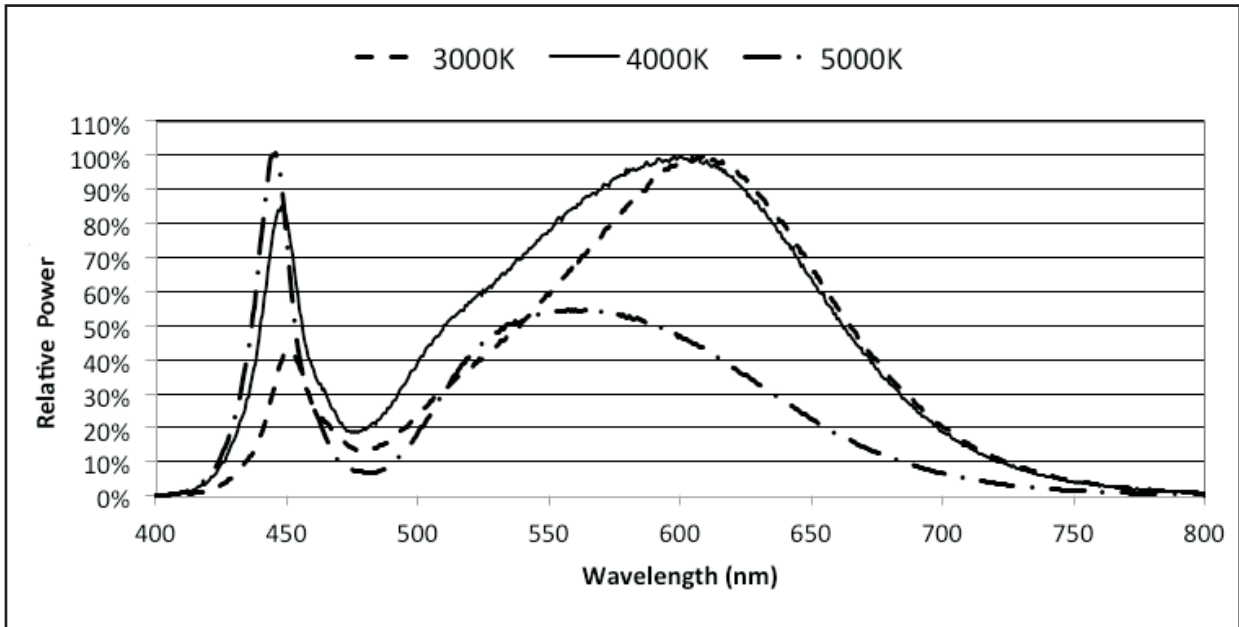

Notes for Figure 10:

1. Characteristics shown for warm white based on 3000K and 80 CRI.
2. Characteristics shown for neutral white based on 4000K and 80 CRI.
3. Characteristics shown for cool white based on 5000K and 70 CRI.
4. For other color SKUs, the shift in color will vary. Please contact your Bridgelux Sales Representative for more information.

Mechanical Dimensions

Figure 11: Drawing for V6 Arrays

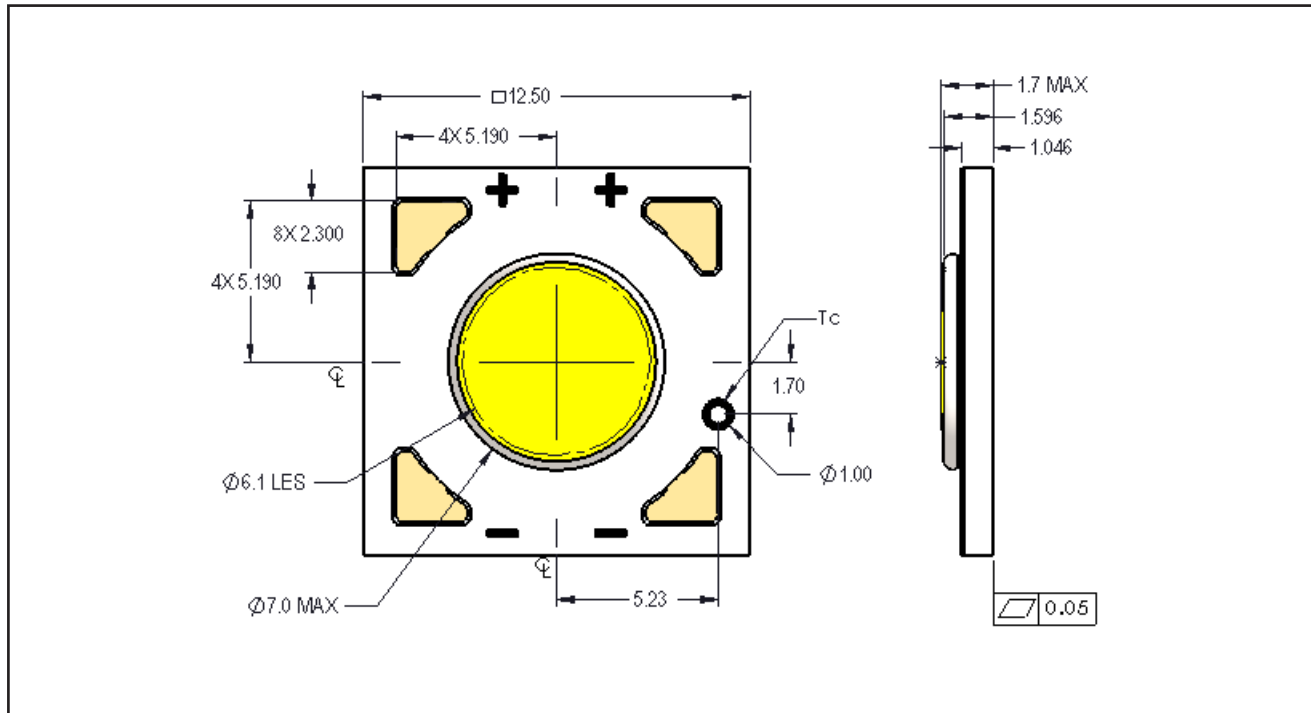

Notes for Figure 11:

1. Solder pads are labeled "+" and "-" to denote positive and negative polarity, respectively.
2. It is not necessary to provide electrical connections to both sets of solder pads. Either set may be used depending on application specific design requirements.
3. Drawings are not to scale.
4. Drawing dimensions are in millimeters.
5. Unless otherwise specified, tolerances are $\pm 0.10\text{mm}$.
6. The optical center of the LED Array is nominally defined by the mechanical center of the array. The light emitting surface (LES) is centered on the mechanical center of the array to a tolerance of $\pm 0.2\text{ mm}$
7. Bridgelux maintains a flatness of 0.1 mm across the mounting surface of the array. Refer to Application Notes AN40 and AN41 for product handling, mounting and heat sink recommendations.

Color Binning Information

Figure 12: Graph of Warm and Neutral White Test Bins in xy Color Space

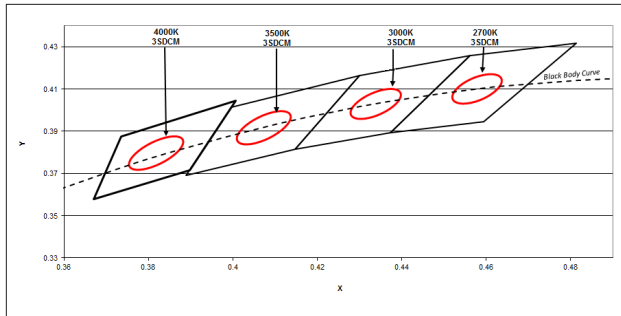

Note: Pulsed Test Conditions, $T_c = 25^\circ\text{C}$

Table 6: Warm and Neutral White xy Bin Coordinates and Associated Typical CCT

Bin Code	2700K	3000K	3500K	4000K
ANSI Bin (for reference only)	(2580K - 2870K)	(2870K - 3220K)	(3220K - 3710K)	(3710K - 4260K)
23 (3SDCM)	(2651K - 2794K)	(2968K - 3136K)	(3369K - 3586K)	(3851K - 4130K)
Center Point (x,y)	(0.4578, 0.4101)	(0.4338, 0.403)	(0.4073, 0.3917)	(0.3818, 0.3797)

Figure 13: Graph of Cool White Test Bins in xy Color Space

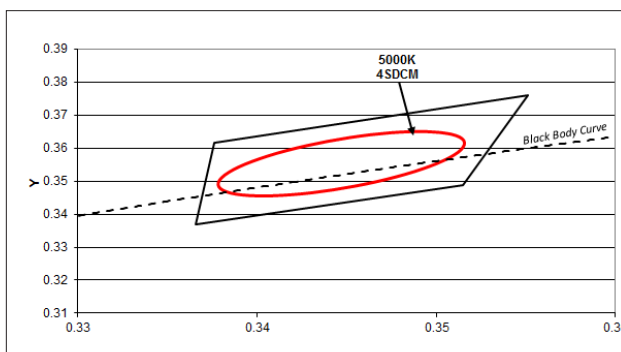

Note: Pulsed Test Conditions, $T_c = 25^\circ\text{C}$

Table 7: Cool White xy Bin Coordinates and Associated Typical CCT

Bin Code	5000K
ANSI Bin (for reference only)	(4745K - 5311K)
24 (4SDCM)	(4801K - 5282K)
Center Point (x,y)	(0.3447, 0.3553)

Packaging and Labeling

Figure 14: Drawing for V6 Packaging Tray

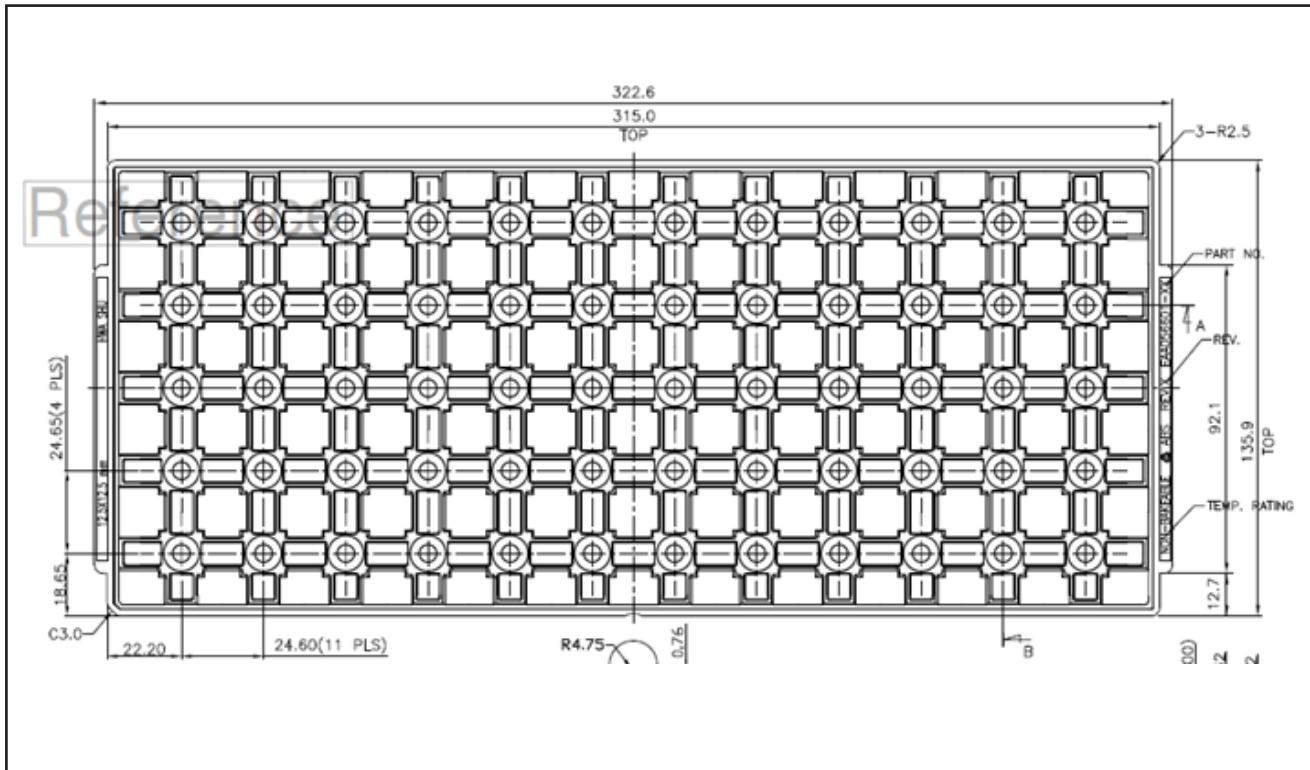

Notes for Figure 14:

1. Dimensions are in millimeters
2. Tolerances: XX - ± 0.25 , XXX - ± 0.13 , X'o' - $\pm 0'30'$
3. Trays are stackable without interference and will not stick together during unstacking operation

Packaging and Labeling

Figure 15: V Series Packaging and Labeling

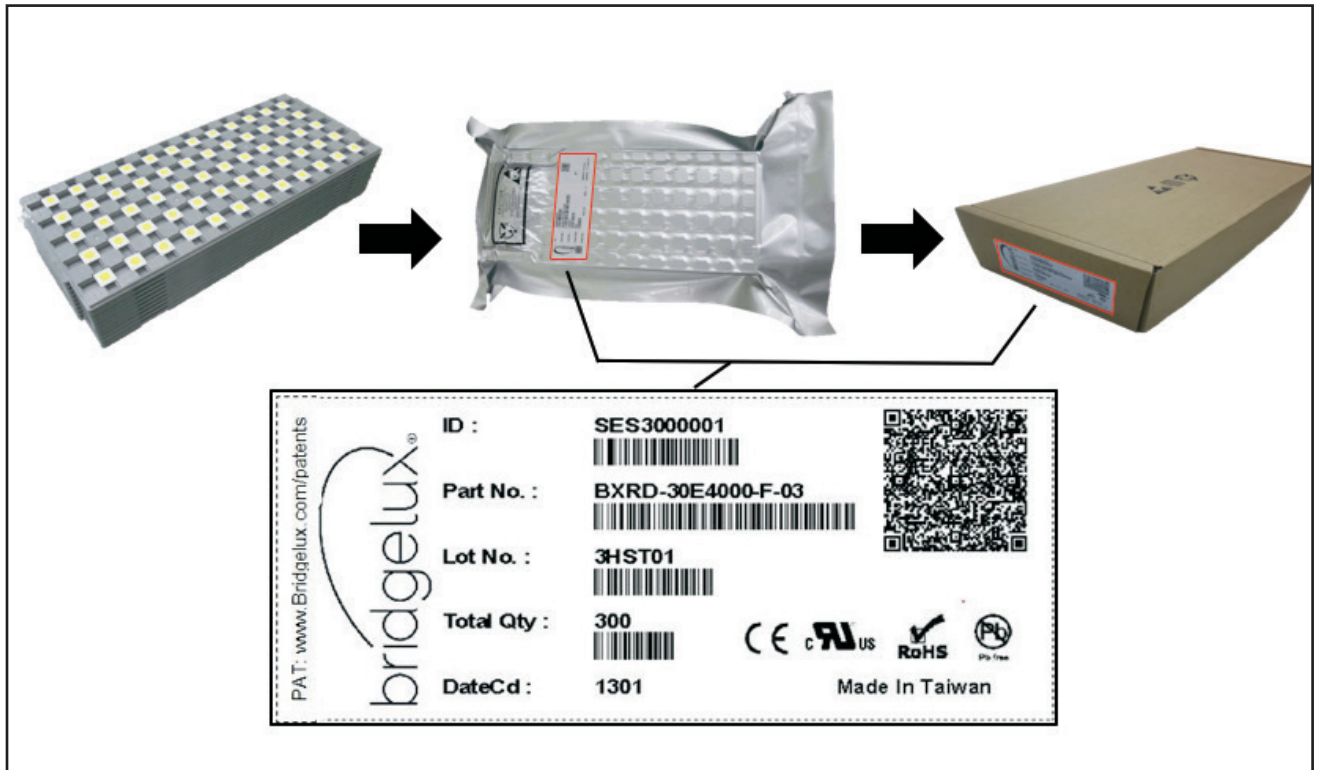

Notes for Figure 15:

1. Each tray holds 60 COB arrays, 10 trays are stacked and one empty tray placed on top to cover the top tray.
2. Stacked trays are to contain only 1 part number and be vacuum sealed in an anti-static bag and placed in its own individual box.
3. Each bag and box is to be labeled as shown above.

Figure 16: Product Labeling

Bridgelux COB arrays have laser markings on the back side of the substrate to help with product identification. In addition to the product identification markings, Bridgelux COB arrays also contain markings for internal Bridgelux manufacturing use only. The image below shows which markings are for customer use and which ones are for Bridgelux internal use only. The Bridgelux internal manufacturing markings are subject to change without notice, however these will not impact the form, function or performance of the COB array.



Design Resources

Application Notes

Bridgelux has developed a comprehensive set of application notes and design resources to assist customers in successfully designing with the V Series product family of LED array products. For a list of resources under development, visit www.bridgelux.com.

Optical Source Models

Optical source models and ray set files are available for all Bridgelux products. For a list of available formats, visit www.bridgelux.com.

3D CAD Models

Three dimensional CAD models depicting the product outline of all Bridgelux V Series LED arrays are available in both IGS and STEP formats. Please contact your Bridgelux sales representative for assistance.

Precautions

CAUTION: CHEMICAL EXPOSURE HAZARD

Exposure to some chemicals commonly used in luminaire manufacturing and assembly can cause damage to the LED array. Please consult Bridgelux Application Note AN41 for additional information.

CAUTION: EYE SAFETY

Eye safety classification for the use of Bridgelux V Series LED arrays is in accordance with IEC specification EN62471: Photobiological Safety of Lamps and Lamp Systems. V Series LED arrays are classified as Risk Group 1 (Low Risk) when operated at or below the maximum drive current. Please use appropriate precautions. It is important that employees working with LEDs are trained to use them safely.

CAUTION: RISK OF BURN

Do not touch the V Series LED array during operation. Allow the array to cool for a sufficient period of time before handling. The V Series LED array may reach elevated temperatures such that could burn skin when touched.

CAUTION

CONTACT WITH LIGHT EMITTING SURFACE (LES)

Avoid any contact with the LES. Do not touch the LES of the LED array or apply stress to the LES (yellow phosphor resin area). Contact may cause damage to the LED array.

Optics and reflectors must not be mounted in contact with the LES (yellow phosphor resin area). Use the mechanical features of the LED array housing, edges and/or mounting holes to locate and secure optical devices as needed.

Disclaimers

MINOR PRODUCT CHANGE POLICY

The rigorous qualification testing on products offered by Bridgelux provides performance assurance. Slight cosmetic changes that do not affect form, fit, or function may occur as Bridgelux continues product optimization.

STANDARD TEST CONDITIONS

Unless otherwise stated, array testing is performed under pulsed conditions at the nominal drive current.

About Bridgelux: We Build Light That Transforms

At Bridgelux, we help companies, industries and people experience the power and possibility of light. Since 2002, we've designed LED solutions that are high performing, energy efficient, cost effective and easy to integrate. Our focus is on light's impact on human behavior, delivering products that create better environments, experiences and returns—both experiential and financial. And our patented technology drives new platforms for commercial and industrial luminaires.

**For more information about the company, please
visit
bridgelux.com
twitter.com/Bridgelux
facebook.com/Bridgelux
WeChat ID: [BridgeluxInChina](#)**



101 Portola Avenue
Livermore, CA 94551
Tel (925) 583-8400
Fax (925) 583-8410
www.bridgelux.com

© 2016 Bridgelux, Inc. All rights reserved 2016. Product specifications are subject to change without notice. Bridgelux, the Bridgelux stylized logo design and V Series are registered trademarks of Bridgelux, Inc. All other trademarks are the property of their respective owners.

Bridgelux V6 Array Series Product Data Sheet DS40 Rev. F (06/2016)

单击下面可查看定价，库存，交付和生命周期等信息

[>>Bridgelux\(普瑞光电\)](#)