

Bridgelux® Vesta™ Tunable Linear Gen 3 1 SMD Row

Product Data Sheet DS136

Lengths: 280mm, 560mm, 1120mm

CRIs: 80, 90

CCT Ranges: 1800K-3000K, 1800K-4000K, 2700-5000K, 2700-6500K



Product Feature Map

Bridgelux Vesta Series Tunable White Linear (TL) modules are fully engineered devices that provide consistent thermal and optical performance on an engineered mechanical platform. The linear products incorporate several features to simplify design integration and assembly. Please visit www.bridgelux.com for more information on the Vesta Series family of products.

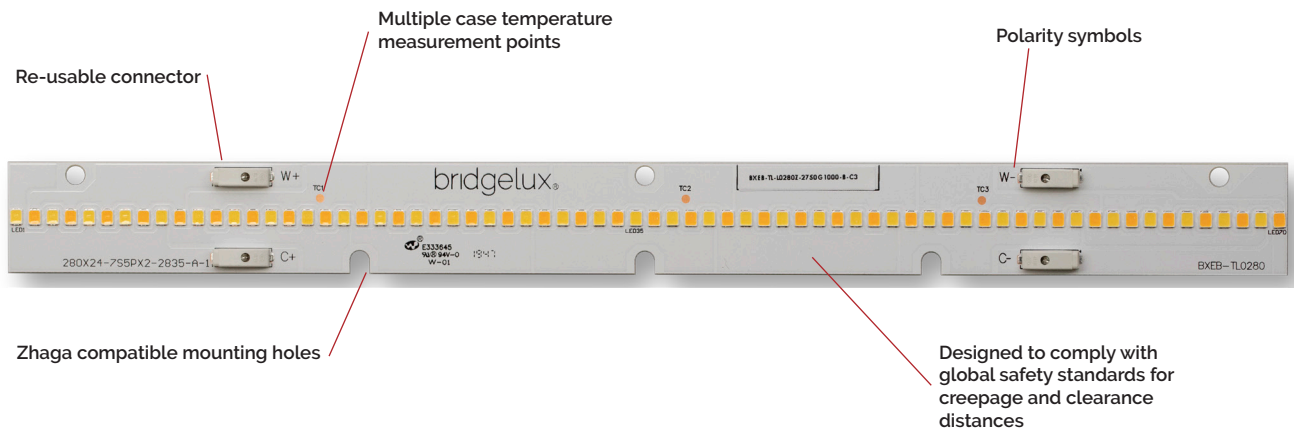

Product Nomenclature

The part number designation for Bridgelux Vesta Series TL Gen 3 with 1 SMD row is explained as follows:

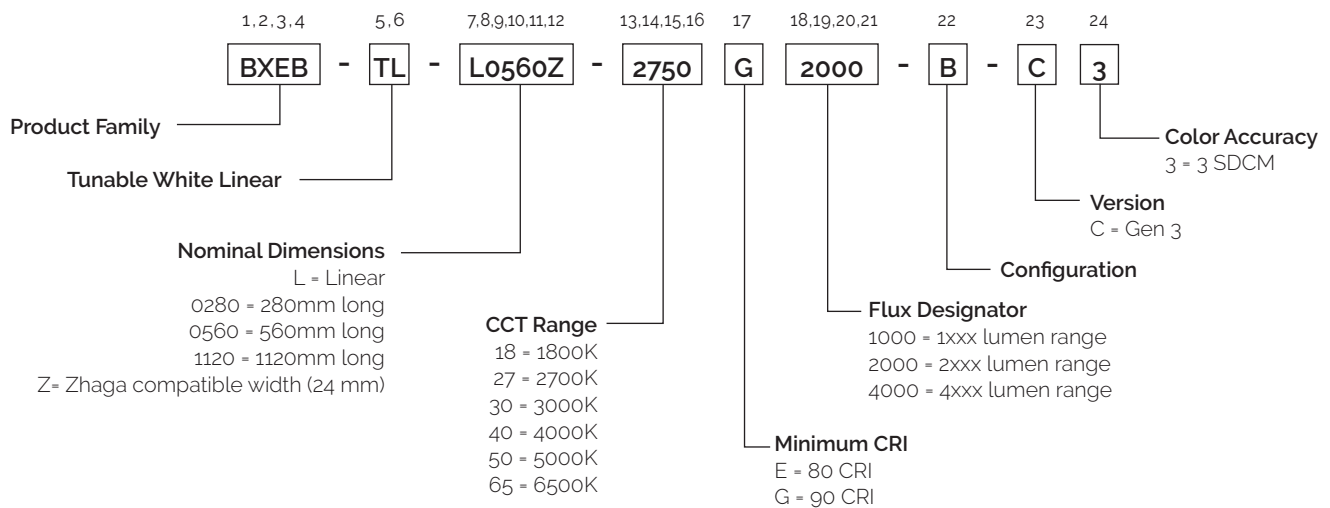

Product Selection Guide

Table 1: Product Performance ($T_c = 25^\circ\text{C}$)

| Part Number | Nominal CCT ¹ (K) | Minimum CRI | Typical Flux ^{2,3} (lm) | Nominal Drive Current (mA) | Typical V_f (V) | Typical Power (W) | Typical Efficacy (lm/W) | | | | | | | | | | | | | | | | | | | | | | | | |
|-------------------------------|------------------------------|-------------|----------------------------------|----------------------------|-------------------|-------------------|-------------------------|------|------|------|------|------|------|------|------|------|------|-----|------|------|------|-----|------|------|------|------|------|------|------|------|-----|
| BXEB-TL-L0280Z-2750E1000-B-C3 | 2700 | 80 | 1219 | 375 | 19.7 | 7.4 | 165 | | | | | | | | | | | | | | | | | | | | | | | | |
| | 5000 | | 1362 | | | | 184 | | | | | | | | | | | | | | | | | | | | | | | | |
| BXEB-TL-L0280Z-2765E1000-B-C3 | 2700 | 80 | 1219 | | | | 375 | 19.7 | 7.4 | 165 | | | | | | | | | | | | | | | | | | | | | |
| | 6500 | | 1346 | | | | | | | 182 | | | | | | | | | | | | | | | | | | | | | |
| BXEB-TL-L0280Z-1830G1000-B-C3 | 1800 | 90 | 755 | | | | | | | 375 | 19.7 | 7.4 | 102 | | | | | | | | | | | | | | | | | | |
| | 3000 | | 1081 | | | | | | | | | | 146 | | | | | | | | | | | | | | | | | | |
| BXEB-TL-L0280Z-1840G1000-B-C3 | 1800 | | 90 | | | | | | | | | | 755 | 375 | 19.7 | 7.4 | 102 | | | | | | | | | | | | | | |
| | 4000 | | | | | | | | | | | | 1153 | | | | 156 | | | | | | | | | | | | | | |
| BXEB-TL-L0280Z-2750G1000-B-C3 | 2700 | | | | | | | | | | | | 90 | | | | 1040 | 375 | 19.7 | 7.4 | 141 | | | | | | | | | | |
| | 5000 | | | | | | | | | | | | | | | | 1153 | | | | 156 | | | | | | | | | | |
| BXEB-TL-L0280Z-2765G1000-B-C3 | 2700 | | | | | | | | | | | | | | | | 90 | | | | 1040 | 375 | 19.7 | 7.4 | 141 | | | | | | |
| | 6500 | | | | | | | | | | | | | | | | | | | | 1153 | | | | 156 | | | | | | |
| BXEB-TL-L0560Z-2750E2000-B-C3 | 2700 | 80 | | | | | | | | | | | | | | | | | | | 2438 | | | | 750 | 19.7 | 14.8 | 165 | | | |
| | 5000 | | | | | | | | | | | | | | | | | | | | 2723 | | | | | | | 184 | | | |
| BXEB-TL-L0560Z-2765E2000-B-C3 | 2700 | | 80 | | | | | | | | | | | | | | | | | | 2438 | | | | | | | 750 | 19.7 | 14.8 | 165 |
| | 6500 | | | | | | | | | | | | | | | | | | | | 2693 | | | | | | | | | | 182 |
| BXEB-TL-L0560Z-1830G2000-B-C3 | 1800 | 90 | | 1510 | 750 | 19.7 | | | | | | | 14.8 | | | | | | | | 102 | | | | | | | | | | |
| | 3000 | | | 2162 | | | | | | | | | | | | | | | | | 146 | | | | | | | | | | |
| BXEB-TL-L0560Z-1840G2000-B-C3 | 1800 | | 90 | 1510 | | | 750 | 19.7 | 14.8 | | | | | | | | 102 | | | | | | | | | | | | | | |
| | 4000 | | | 2305 | | | | | | | | | | | | | 156 | | | | | | | | | | | | | | |
| BXEB-TL-L0560Z-2750G2000-B-C3 | 2700 | | | 90 | | | | | | 2081 | 750 | 19.7 | | | | | 14.8 | | | | 141 | | | | | | | | | | |
| | 5000 | | | | | | | | | 2305 | | | | | | | | | | | 156 | | | | | | | | | | |
| BXEB-TL-L0560Z-2765G2000-B-C3 | 2700 | | | | | | | | | 90 | | | | 2081 | 750 | 19.7 | | | | | 14.8 | | | | | | | | | | 141 |
| | 6500 | | | | | | | | | | | | | 2305 | | | | | | | | | | | | | | | | | 156 |
| BXEB-TL-L1120Z-2750E4000-B-C3 | 2700 | 80 | | | | | | | | | | | | 4876 | | | | 750 | 39.4 | 29.6 | | | | | | | | | | | 165 |
| | 5000 | | | | | | | | | | | | | 5447 | | | | | | | | | | | | | | | | | 184 |
| BXEB-TL-L1120Z-2765E4000-B-C3 | 2700 | | 80 | | | | | | | | | | | 4876 | | | | | | | | 750 | 39.4 | 29.6 | | | | | | | 165 |
| | 6500 | | | | | | | | | | | | | 5386 | | | | | | | | | | | | | | | | | 182 |
| BXEB-TL-L1120Z-1830G4000-B-C3 | 1800 | 90 | | 3019 | | | | | | | | | | 750 | | | | | | | | | | | 39.4 | 29.6 | 102 | | | | |
| | 3000 | | | 4325 | | | | | | | | | | | | | | | | | | | | | | | 146 | | | | |
| BXEB-TL-L1120Z-1840G4000-B-C3 | 1800 | | 90 | 3019 | | | | | | 750 | | | | | | | | | | | | | | | | | 39.4 | 29.6 | 102 | | |
| | 4000 | | | 4610 | | | | | | | | | | | | | | | | | | | | | | | | | 156 | | |
| BXEB-TL-L1120Z-2750G4000-B-C3 | 2700 | | | 90 | 4162 | 750 | | | | | | | 39.4 | | | | | | | | | | | | | | | | 29.6 | 141 | |
| | 5000 | | | | 4610 | | | | | | | | | | | | | | | | | | | | | | | | | 156 | |
| BXEB-TL-L1120Z-2765G4000-B-C3 | 2700 | | | | 90 | | 4162 | 750 | 39.4 | | | | | | | | | | | | | | | | | | | | | 29.6 | 141 |
| | 6500 | | | | | | 4610 | | | | | | | | | | | | | | | | | | | | | | | | 156 |

Notes for Table 1:

1. Nominal CCT as defined by ANSI C78.377-2011.
2. Data is at nominal test current where temperature of center case temperature point $T_c = 25^\circ\text{C}$.
3. Bridgelux maintains a $\pm 7\%$ tolerance on typical flux data (typical SMD flux bins)

Electrical Characteristics

Table 2: Electrical Characteristics

| Part Number | Drive Current (mA) | Forward Voltage $T_{c2} = 25^{\circ}\text{C}$ (V) ^{1, 2, 3} | | | Typical Coefficient of Forward Voltage ⁴ $\Delta V_f / \Delta T$ (mV/ $^{\circ}\text{C}$) | Driver Selection Voltages ⁵ (V) | |
|-------------------------------|--------------------|---|---------|---------|--|---|---|
| | | Minimum | Typical | Maximum | | V_f Min, Hot $T_{c2} = 85^{\circ}\text{C}$ (V) | V_f Max, Cold $T_{c2} = -40^{\circ}\text{C}$ (V) |
| BXEB-TL-L0280Z-xxxxE1000-B-C3 | 375 | 18.3 | 19.7 | 21.1 | -5.4 | 18.0 | 21.4 |
| | 750 | 19.3 | 20.8 | 22.3 | | 19.0 | 22.6 |
| BXEB-TL-L0280Z-xxxxG1000-B-C3 | 375 | 18.3 | 19.7 | 21.1 | -5.4 | 18.0 | 21.4 |
| | 750 | 19.3 | 20.8 | 22.3 | | 19.0 | 22.6 |
| BXEB-TL-L0560Z-xxxxE2000-B-C3 | 750 | 18.3 | 19.7 | 21.1 | -5.4 | 18.0 | 21.4 |
| | 1500 | 19.3 | 20.8 | 22.3 | | 19.0 | 22.6 |
| BXEB-TL-L0560Z-xxxxG2000-B-C3 | 750 | 18.3 | 19.7 | 21.1 | -5.4 | 18.0 | 21.4 |
| | 1500 | 19.3 | 20.8 | 22.3 | | 19.0 | 22.6 |
| BXEB-TL-L1120Z-xxxxE4000-B-C3 | 750 | 36.6 | 39.4 | 42.2 | -10.8 | 36.0 | 42.9 |
| | 1500 | 38.7 | 41.6 | 44.5 | | 38.0 | 45.2 |
| BXEB-TL-L1120Z-xxxxG4000-B-C3 | 750 | 36.6 | 39.4 | 42.2 | -10.8 | 36.0 | 42.9 |
| | 1500 | 38.7 | 41.6 | 44.5 | | 38.0 | 45.2 |

Notes for Table 2:

1. Voltage minimum and maximum are provided for reference only and are not a guarantee of performance.
2. Bridgelux maintains a tolerance of ± 0.1 V on forward voltage data.
3. This product has been designed and manufactured per IEC 62031:2014. The working voltage designated for the insulation is 60 Vdc. The maximum allowable voltage across the module must be determined in the end product application.
4. Typical coefficient of forward voltage tolerance is ± 0.1 mV for nominal current.
5. V_f min hot and max cold values are provided as reference only and are not guaranteed. These values are provided to aid in driver design and selection over the operating range of the product.

Absolute Maximum Ratings

Table 3: Maximum Ratings

| Parameter | Maximum Rating | | |
|---|---|-------------------------------|-------------------------------|
| Storage Temperature | -40°C to +85°C | | |
| Operating Case Temperature ² (T _c) | 85°C | | |
| Soldering Temperature | 350°C or lower for a maximum of 5 seconds | | |
| Maximum Reverse Voltage | Modules are not designed to be driven in reverse bias | | |
| | BXEB-TL-L0280Z-xxxxy1000-B-C3 | BXEB-TL-L0560Z-xxxxy2000-B-C3 | BXEB-TL-L1120Z-xxxxy4000-B-C3 |
| Drive Current, Maximum Combined ³ | 750 mA | 1500 mA | 1500 mA |
| Drive Current, Maximum Per Channel ³ | 750 mA | 1500 mA | 1500 mA |

Notes for Table 3

- For IEC 62717 requirement, please consult your Bridgelux sales representative.
- Lumen maintenance (L70) and lifetime predictions are valid for drive current and case temperature conditions used for LM-80 testing as included in the applicable LM-80 test report for the SMDs used in the modules. Contact your Bridgelux sales representatives for LM-80 report.
- The Maximum Combined Drive Current is defined as the sum of the drive currents in both channels.
 - Example #1: If 750mA is applied to the 2700K (warm white) channel of the BXEB-TL-L0280Z-27xy1000-B-C3 module, then 0mA may be applied to the alternate cool white channel.
 - Example #2: If 1000mA is applied to the cool white channel of the BXEB-TL-L0560Z-27xy2000-B-C3 module, then a maximum of 500mA may be applied to the warm white channel.

Performance Curves

Figure 1: Current vs. Forward Voltage (280mm only)

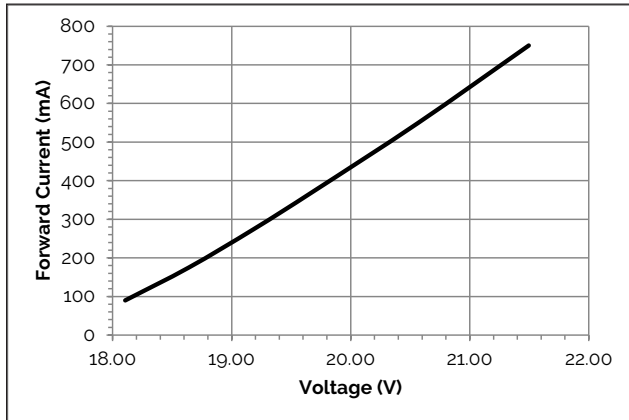

Figure 2: Flux vs. Current (280mm only)

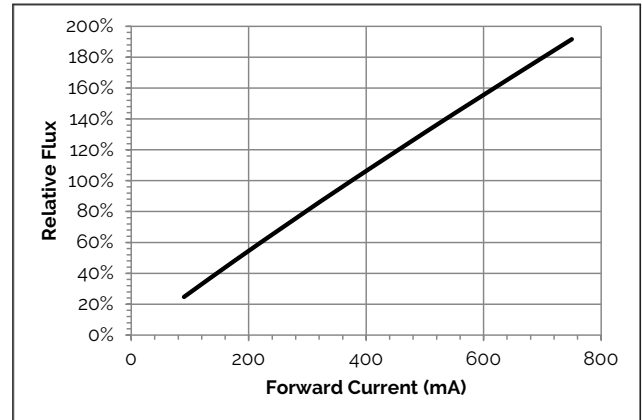

Figure 3: Current vs. Forward Voltage (560mm only)

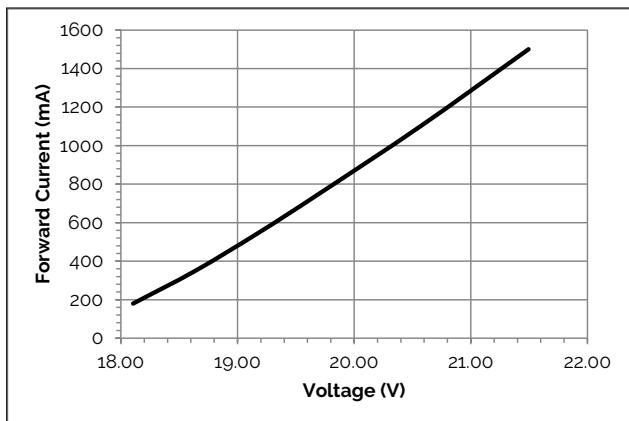

Figure 4: Flux vs. Current (560mm only)

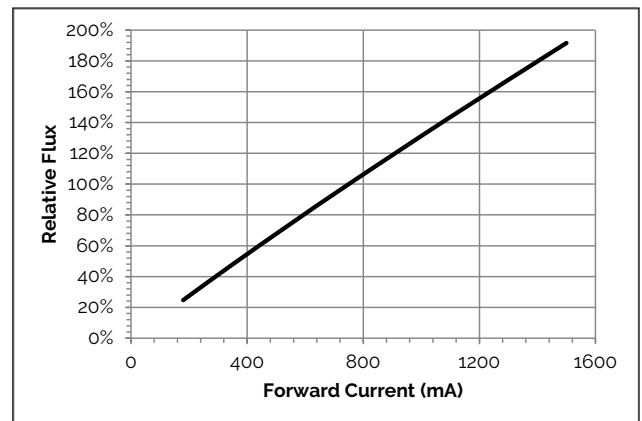

Figure 5: Current vs. Forward Voltage (1120mm only)

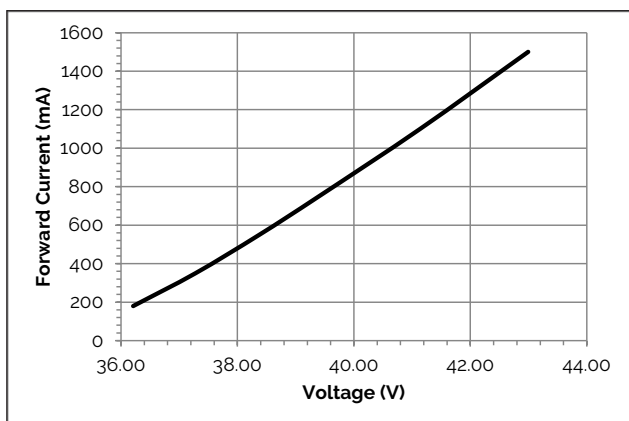
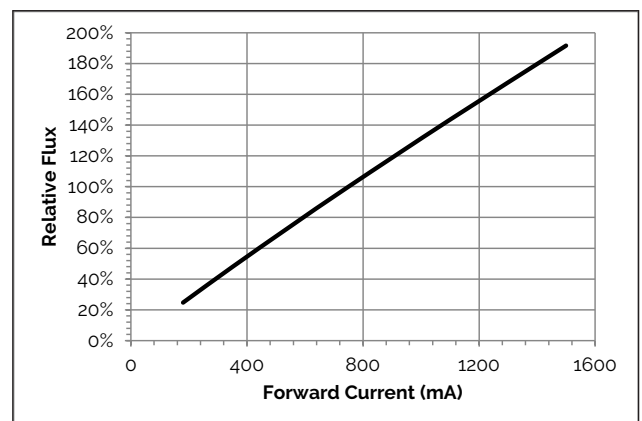

Figure 6: Flux vs. Current (1120mm only)



Notes for Figures 1-6:

1. All measurements were performed at $T_c=25^\circ\text{C}$

Performance Curves

Figure 7: Flux vs. Current Ratio (2700K-5000K)

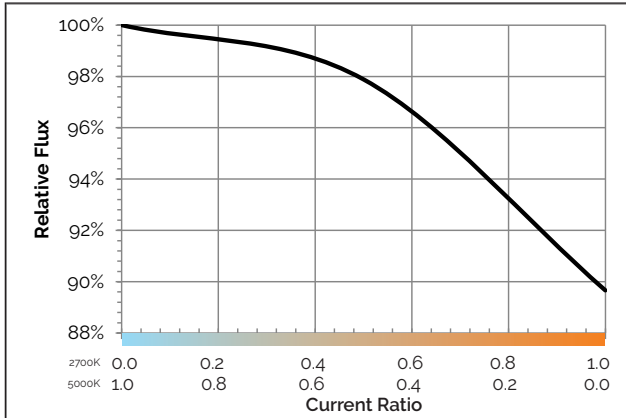

Figure 8: CCT vs. Current Ratio (2700K-5000K)

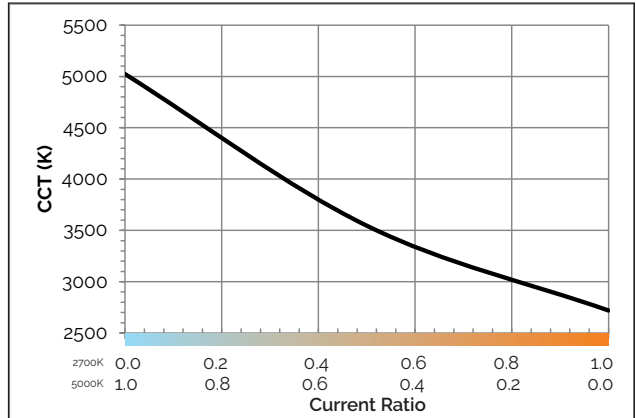

Figure 9: Flux vs. Current Ratio (2700K-6500K)

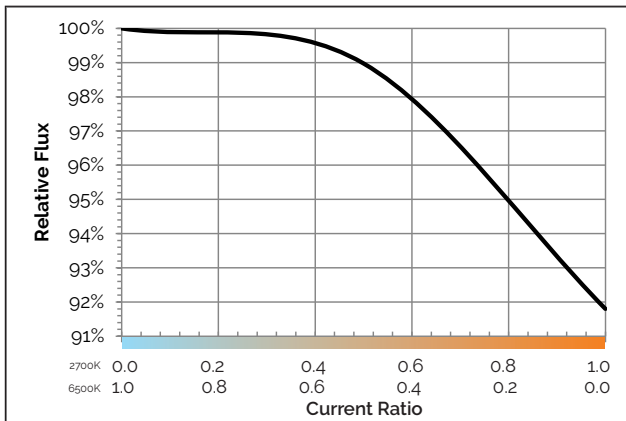

Figure 10: CCT vs. Current Ratio (2700K-6500K)

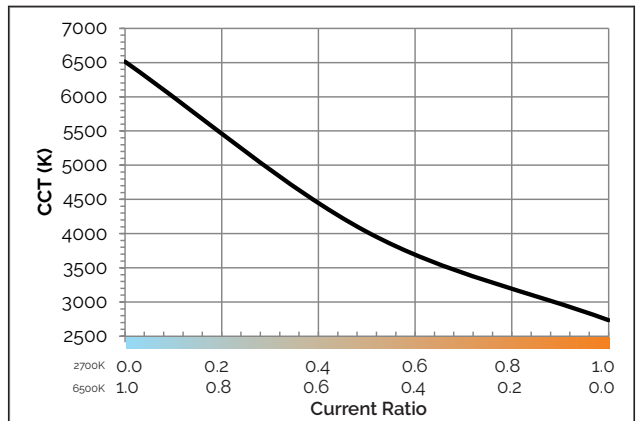

Figure 11: Flux vs. Current Ratio (1800K-3000K)

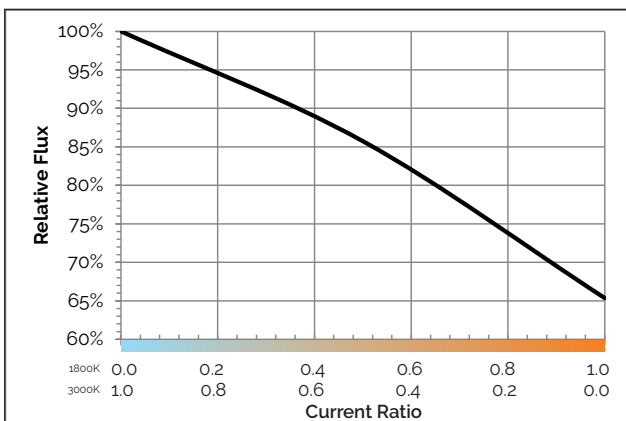
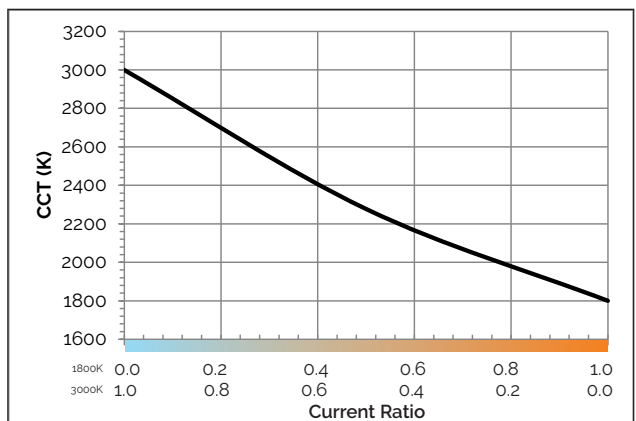

Figure 12: CCT vs. Current Ratio (1800K-3000K)



Notes for Figures 7-12:

1. All measurements were performed at $T_c = 25^\circ\text{C}$
2. Current Ratio is calculated by dividing the channel with the lower drive current by the channel with the higher drive current. For example if the CW channel is operated at 1200mA and the WW channel is operated at 300mA, then the WW current ratio = $300/1200 = 0.25$

Performance Curves

Figure 13: Flux vs. Current Ratio (1800K-4000K)

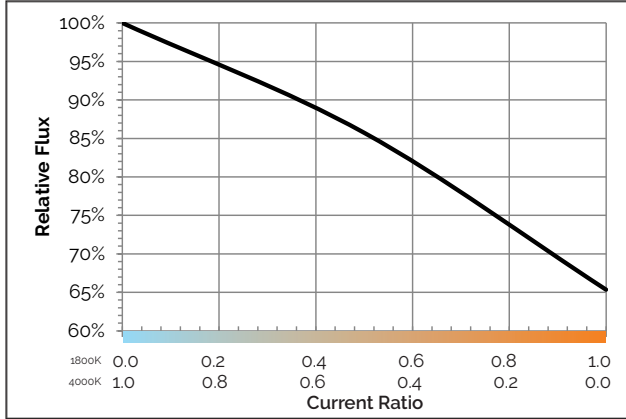
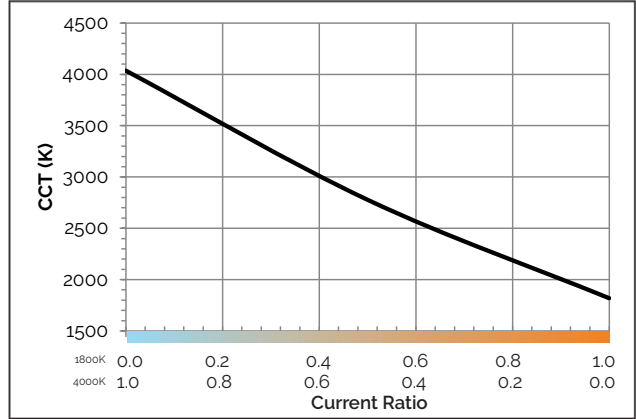

Figure 14: CCT vs. Current Ratio (1800K-4000K)



Notes for Figures 13-14:

1. All measurements were performed at $T_c = 25^\circ\text{C}$
2. Current Ratio is calculated by dividing the channel with the lower drive current by the channel with the higher drive current. For example if the CW channel is operated at 1200mA and the WW channel is operated at 300mA, then the WW current ratio = $300/1200 = 0.25$

Figure 15: Voltage vs Case Temperature

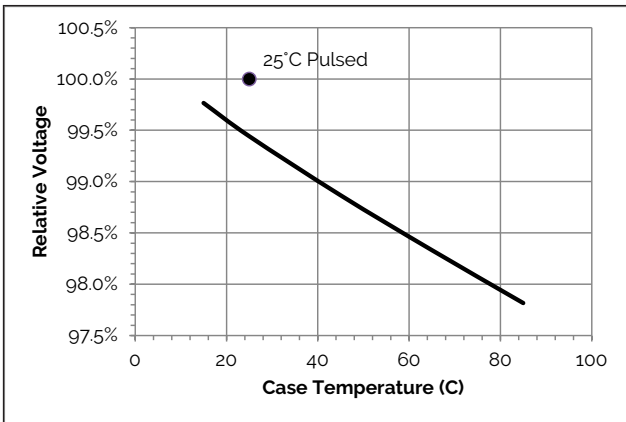

Figure 16: Flux vs Case Temperature (2700K-5000K)

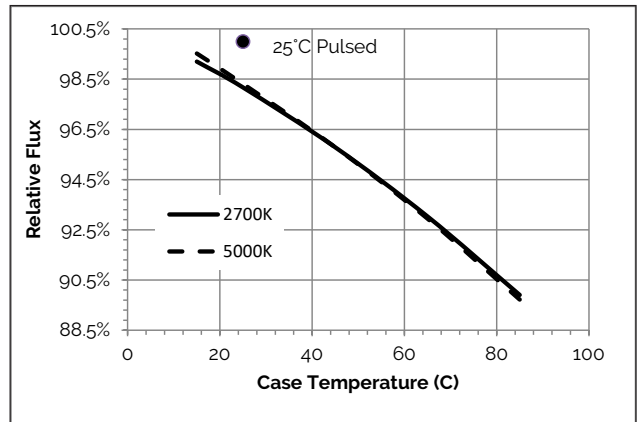

Figure 17: Flux vs Case Temperature (2700K-6500K)

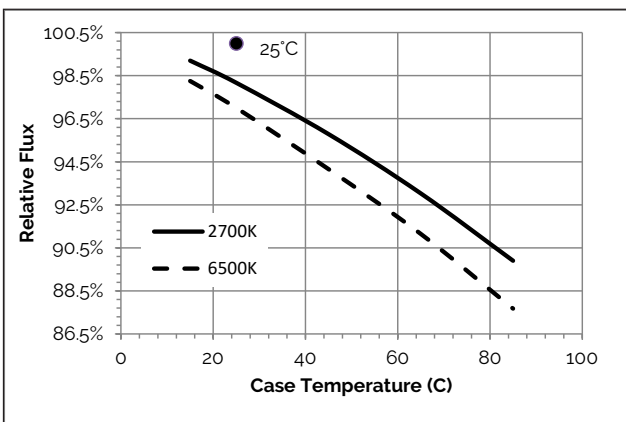
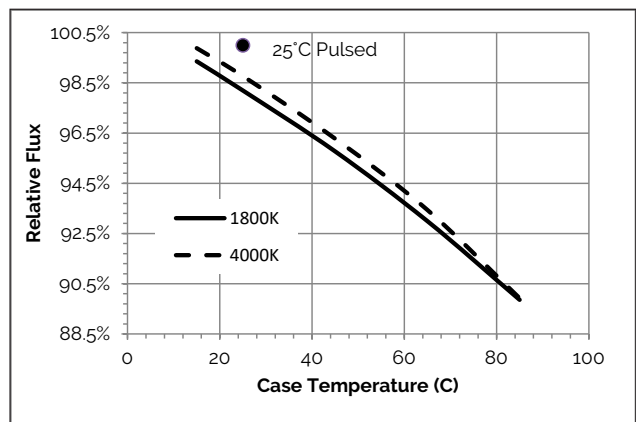
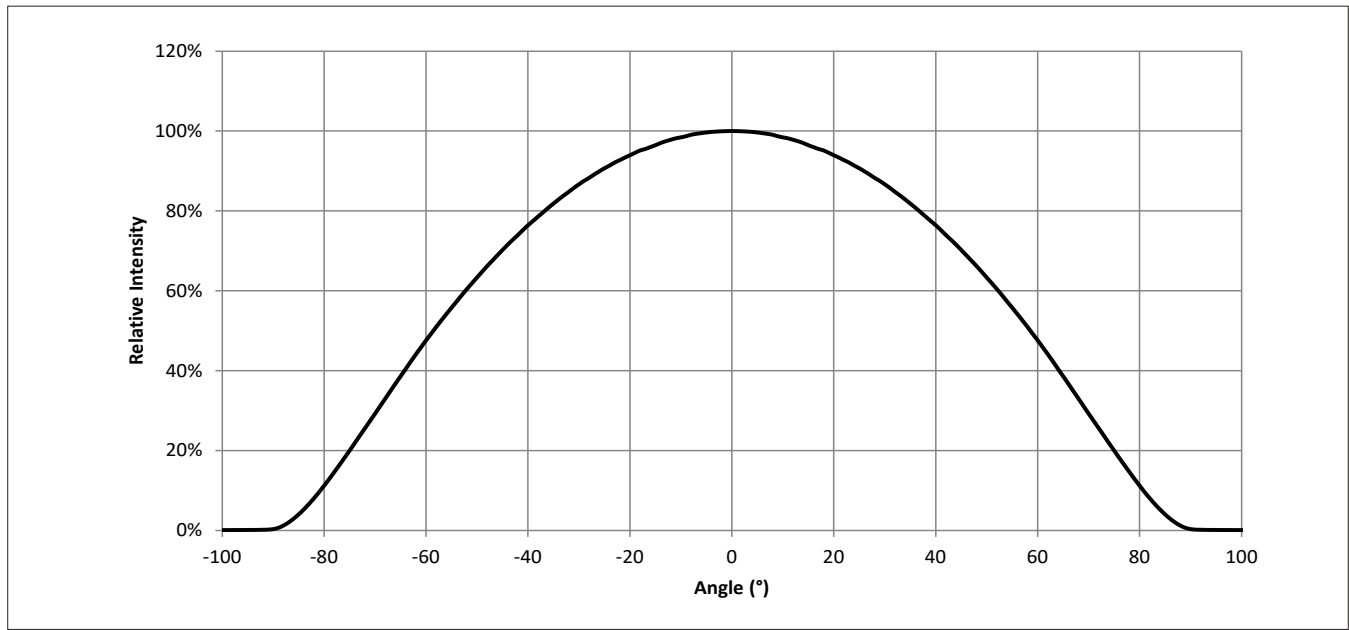

Figure 18: Flux vs Case Temperature (1800K-4000K)



Typical Radiation Pattern

Figure 19: Typical Spatial Radiation Pattern



Notes for Figure 19:

1. Typical viewing angle is 120°.FWHM
2. The viewing angle is defined as the full-width off-axis angle where the intensity is 50% of the peak value.

Typical Color Spectrum

Figure 20: Typical Color Spectra, 80 CRI

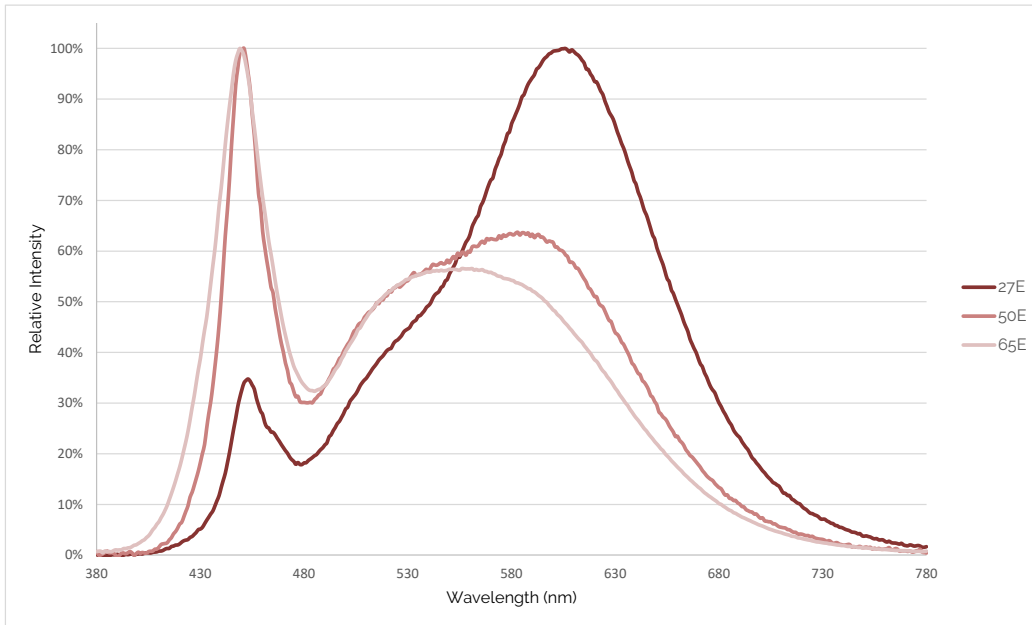
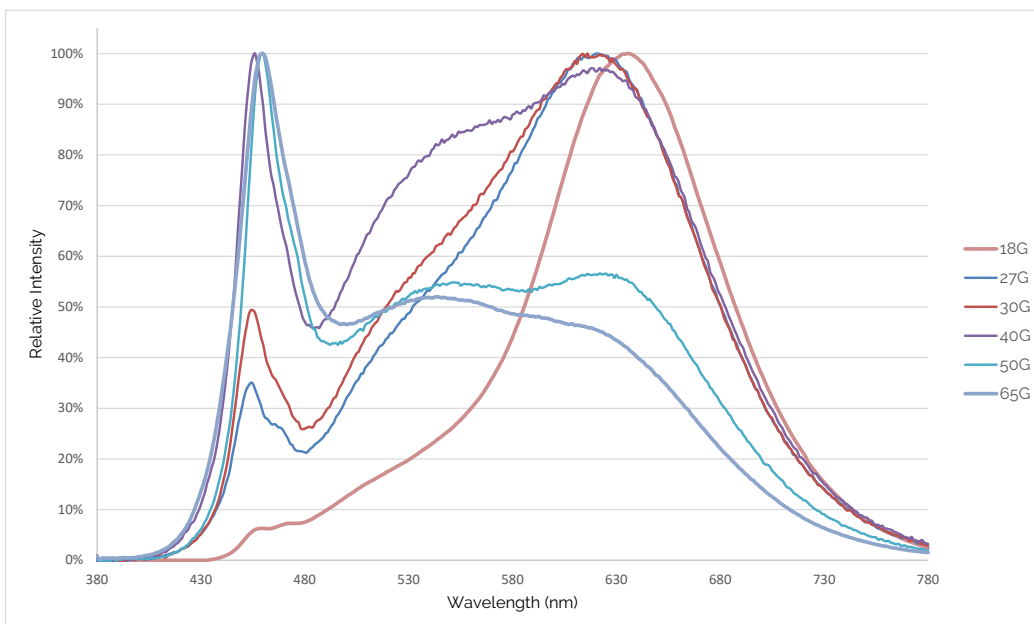

Figure 21: Typical Color Spectra, 90 CRI



Note for Figures 20 & 21:

1. Color spectra measured at nominal current for $T_c = 65^\circ\text{C}$

Mechanical Dimensions

Figure 22: Drawing Overview for 280mm

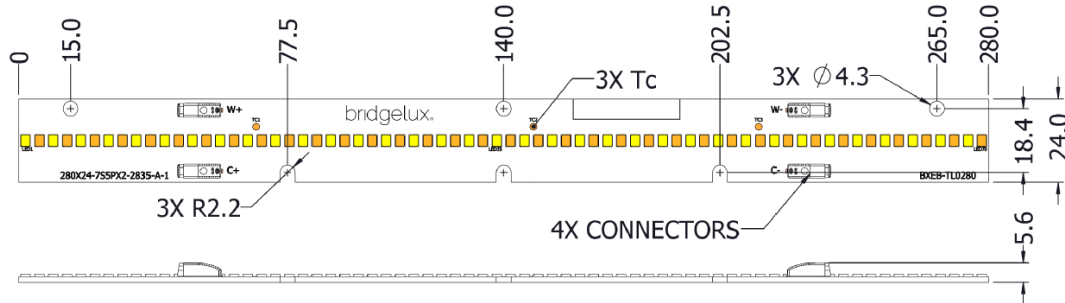

Figure 23: Drawing Overview for 560mm

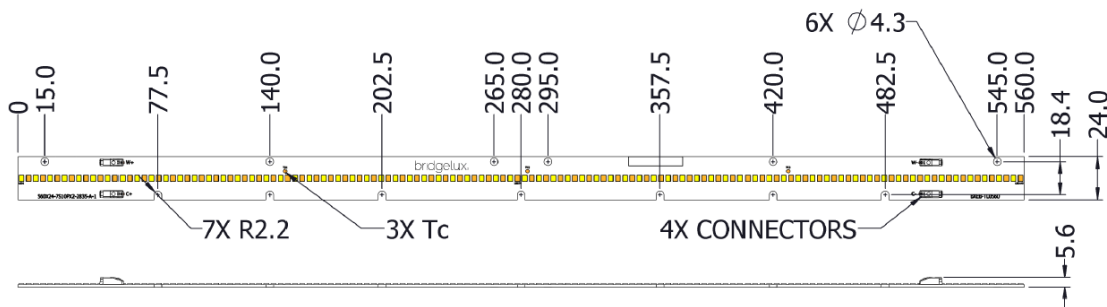
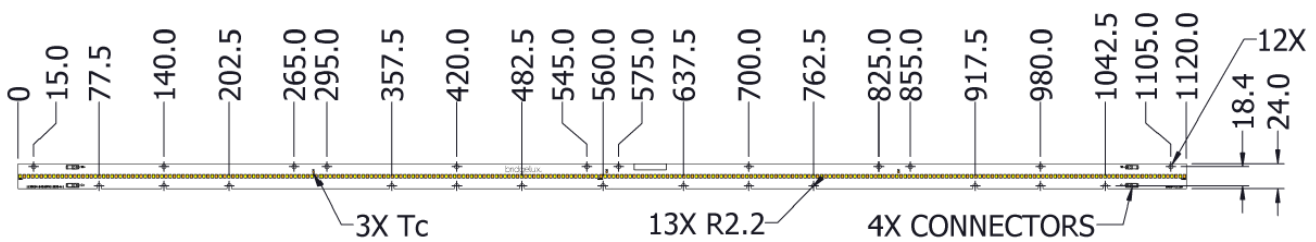

Figure 24: Drawing Overview for 1120mm



Notes for Figures 22, 23 & 24:

1. Solder pads are labeled "+" to denote positive polarity, and "-" to denote negative polarity.
2. "W" labels stand for Warm White and refer to the low CCT SMDs on the module (i.e. 1800K or 2700K). "CW" labels stand for Cool White and refer to the high CCT SMDs on the module (i.e. 3000K, 4000K, 5000K, or 6500K)
3. Dimensions are in millimeters.
4. Refer to Bridgelux assembly drawing 15-000718, 15-000719, and 15-000720 for complete product configuration

Table 5: Module Dimensions & Connector Wiring

| Parameter | BXEB-TL-L0280Z-xxxxxy1000-B-C3 | BXEB-TL-L0560Z-xxxxxy2000-B-C3 | BXEB-TL-L1120Z-xxxxxy4000-B-C3 |
|--------------------------|--------------------------------|--------------------------------|--------------------------------|
| Linear length | 280.0 mm | 560.0 mm | 1120.0 mm |
| Linear width | 24 mm | | |
| Overall thickness | 5.6 mm | | |
| PCB thickness | 1.6 mm | | |
| Input wire cross-section | 18-24 AWG | | |
| Wire strip length | 7-9 mm | | |

Color Binning Information

Figure 25: 3 SDCM Color Bins in CIE 1931 xy Color Space

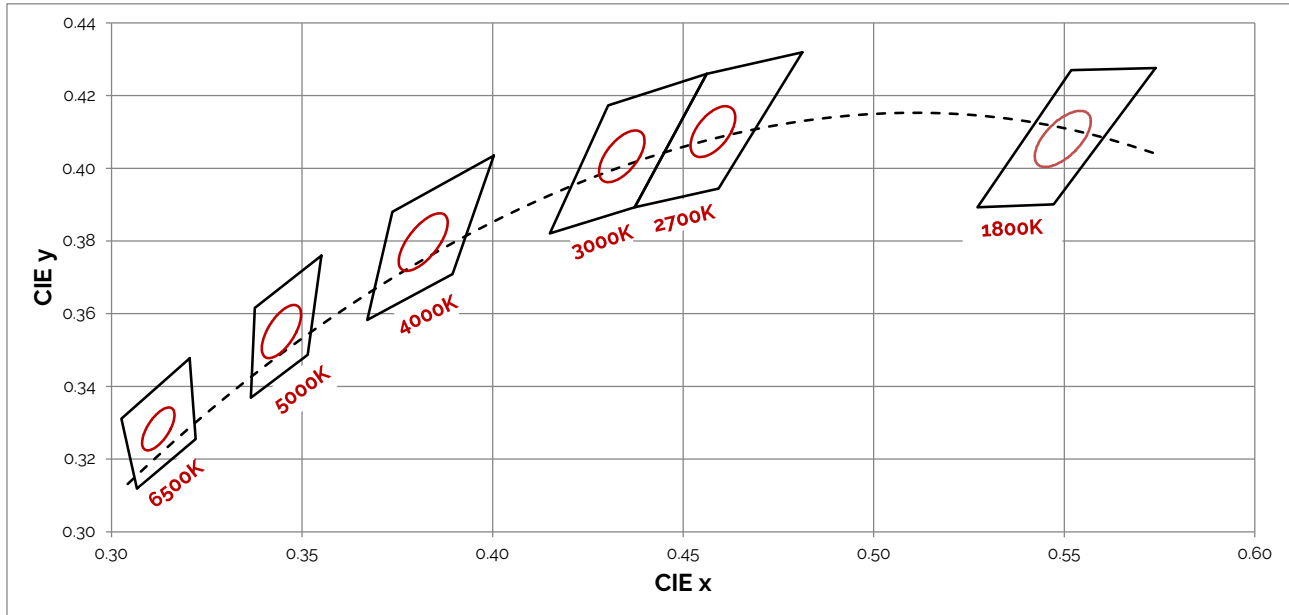

Table 6: Bin Coordinates and Associated Typical CCT

| CCT | Color Consistency | CIE Center Point (x, y) | Corresponding CCT Range |
|-------|-------------------|-------------------------|-------------------------|
| 1800K | 3 SDCM | (0.550, 0.408) | 1750K - 1840K |
| 2700K | 3 SDCM | (0.458, 0.410) | 2651K - 2794K |
| 3000K | 3 SDCM | (0.434, 0.403) | 2968K - 3136K |
| 4000K | 3 SDCM | (0.382, 0.380) | 3851K - 4130K |
| 5700K | 3 SDCM | (0.345, 0.355) | 4835K - 5215K |
| 6500K | 3 SDCM | (0.312, 0.328) | 6250K - 6745K |

Notes for Table 6

1. Color binning at solder point temperature Tsp of SMDs at 25°C for 80 CRI and 85°C for 90 CRI.
2. Bridgelux maintains a tolerance of ± 0.007 on x and y color coordinates in the CIE 1931 color space.
3. Quadrangular ANSI bins shown for reference only

Packaging and Labeling

Figure 26: Vesta Series Packaging and Labeling

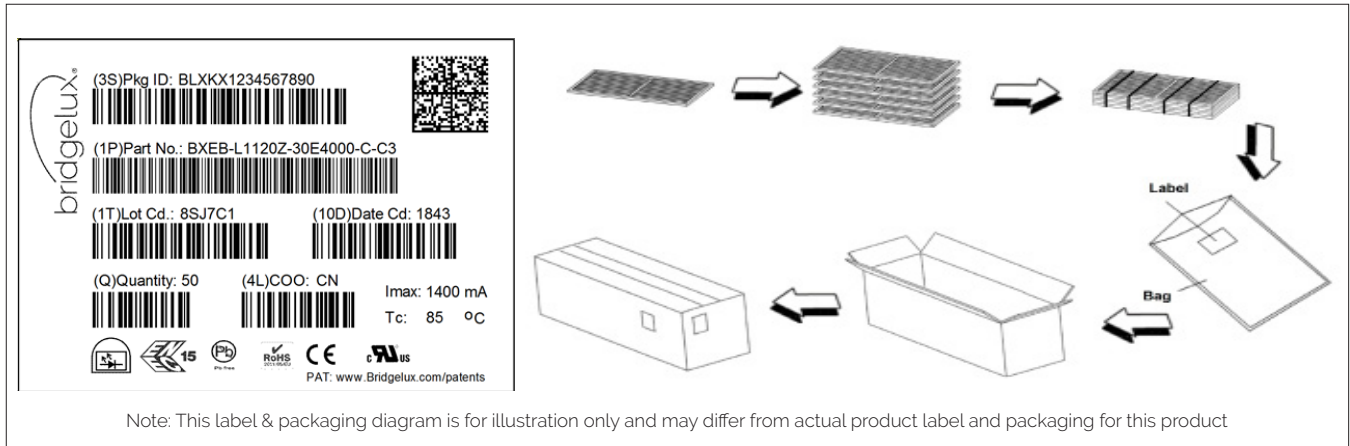

Table 7: Packaging Structure

| Box Parameter | L0280 modules | L0560 modules | L1120 modules |
|---------------|-----------------------------|-----------------------------|------------------------------|
| Quantity | 200 | 100 | 100 |
| Dimension | 34.6 cm x 29.6 cm x 16.9 cm | 60.0 cm x 19.4 cm x 16.9 cm | 115.9 cm x 19.4 cm x 16.9 cm |

Figure 27: Product Labeling

Bridgelux Vesta Series modules contain a label on the front to help with product identification. In addition to the product identification markings, Bridgelux Vesta Series modules also contain markings for internal Bridgelux manufacturing use only. The image below shows which markings are for customer use and which ones are for Bridgelux internal use only. The Bridgelux internal manufacturing markings are subject to change without notice, however these will not impact the form, function or performance of the module.



Vesta Series Gen3
280mm 1000lm 375mA

Customer Use- 2D Barcode
Scannable barcode provides
product part number and other
Bridgelux internal production
information.

Design Resources

Application Notes

Bridgelux has developed a comprehensive set of application notes and design resources to assist customers in successfully designing with the Vesta Series product family. For a list of resources under development, visit www.bridgelux.com.

Optical Source Models

Optical source models and ray set files are available for all Bridgelux products. For a list of available formats, visit www.bridgelux.com.

3D CAD Models

Three dimensional CAD models depicting the product outline of all Bridgelux Vesta Series modules are available in both IGES and STEP formats. Please contact your Bridgelux sales representative for assistance.

Precautions

CAUTION: CHEMICAL EXPOSURE HAZARD

Exposure to some chemicals commonly used in luminaire manufacturing and assembly can cause damage to the LED linear. Please consult Bridgelux Application Note for additional information.

CAUTION: EYE SAFETY

Eye safety classification for the use of Bridgelux Vesta Series is in accordance with IEC/TR62778: Application of IEC 62471 for the assessment of blue light hazard to light sources and luminaires. Vesta Series linears are classified as Risk Group 1 (TBD) when operated at or below the maximum drive current. Please use appropriate precautions. It is important that employees working with LEDs are trained to use them safely.

CAUTION: RISK OF BURN

Do not touch the Vesta Series modules during operation. Allow the linear to cool for a sufficient period of time before handling. The Vesta Series modules may reach elevated temperatures such that could burn skin when touched.

CAUTION

CONTACT WITH LIGHT EMITTING SURFACE (LES)

Avoid any contact with the LES. Do not touch or apply stress to the module SMD LESs (yellow phosphor resin area). Contact may cause damage to the module.

Optics and reflectors must not be mounted in contact with the LES (yellow phosphor resin area).

Optical devices may be mounted on the top surface of the module. Use the mechanical features of the module housing, edges and/or mounting holes to locate and secure optical devices as needed.

Disclaimers

STANDARD TEST CONDITIONS

Unless otherwise stated, module testing is performed at the nominal drive current.

MINOR PRODUCT CHANGE POLICY

The rigorous qualification testing on products offered by Bridgelux provides performance assurance. Slight cosmetic changes that do not affect form, fit, or function may occur as Bridgelux continues product optimization.

About Bridgelux: Bridging Light and Life™

At Bridgelux, we help companies, industries and people experience the power and possibility of light. Since 2002, we've designed LED solutions that are high performing, energy efficient, cost effective and easy to integrate. Our focus is on light's impact on human behavior, delivering products that create better environments, experiences and returns—both experiential and financial. And our patented technology drives new platforms for commercial and industrial luminaires.

For more information about the company, please visit

bridgelux.com

twitter.com/Bridgelux

facebook.com/Bridgelux

youtube.com/user/Bridgelux

linkedin.com/company/Bridgelux

WeChat ID: BridgeluxInChina



46430 Fremont Blvd
Fremont, CA 94538 USA
Tel (925) 583-8400
Fax (925) 583-8401
www.bridgelux.com

© 2020 Bridgelux, Inc. All rights reserved. Product specifications are subject to change without notice. Bridgelux and the Bridgelux stylized logo design and Vesta are registered trademarks of Bridgelux, Inc. EB Series and Bridging Light and Life are trademarks of Bridgelux, Inc. All other trademarks are the property of their respective owners.

Bridgelux Vesta TL Gen3 1R Data Sheet DS136 Rev. A (06/2020)

单击下面可查看定价，库存，交付和生命周期等信息

[>>Bridgelux\(普瑞光电\)](#)