

Bridgelux® V8 Array Series

Product Data Sheet DS41



BXPE-27x0800 | 20x0800 | 35x0800 | 40x0800 | 50x0800

Introduction

V Series

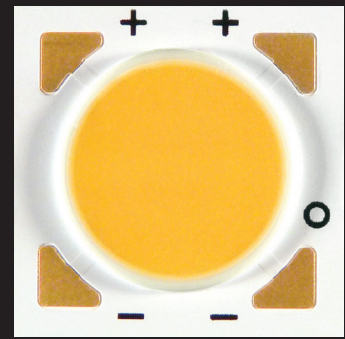

The V Series LED Array products deliver high quality light in a compact and cost-effective solid-state lighting package. These Chip-on-Board (CoB) arrays can be efficiently driven at twice the nominal drive current, enabling design flexibility not previously possible. This high flux density light source is designed to support a wide range of high quality, low cost directional luminaires and replacement lamps for commercial and residential applications.

The V8 LED Array is available in a variety of electrical, CCT and CRI combinations providing substantial design flexibility and energy efficiencies.

Lighting system designs incorporating these LED Arrays deliver comparable performance to 7-13 Watt compact fluorescent and 40-75 Watt incandescent and halogen based luminaires, delivering increased system level efficacy and longer service life. Typical applications include, but are not limited to, replacement lamps, task, accent, spot, track, down light, wide area, security, and wall pack.

Features

- Efficacy of 130 lm/W typical
- Compact high flux density light source
- Uniform high quality illumination
- Minimum 70, 80 and 90 CRI options
- Streamlined thermal path
- Energy Star / ANSI compliant color binning structure with 3SDCM and 4SDCM options
- More energy efficient than incandescent, halogen and fluorescent lamps
- Low voltage DC operation
- Instant light with unlimited dimming

Benefits

- Enhanced optical control
- Clean white light without pixilation
- High quality true color reproduction
- Significantly reduced thermal resistance and increased operating temperatures
- Uniform consistent white light
- Lower operating costs
- Easy to use with daylight and motion detectors to enable increased energy savings
- Reduced maintenance costs
- Environmentally friendly, no disposal issue



Contents

Product Feature Map	2
Product Nomenclature	2
Product Selection Guide	3
Performance at Commonly Used Drive Currents	4
Electrical Characteristics	7
Absolute Maximum Ratings	8
Performance Curves	9
Typical Radiation Pattern	13
Typical Color Spectrum	14
Mechanical Dimensions	15
Color Binning Information	16
Packaging and Labeling	17
Design Resources	19
Precautions	19
Disclaimers	19
About Bridgelux	20

Product Feature Map

Bridgelux arrays are fully engineered devices that provide consistent thermal and optical performance on an engineered mechanical platform. The V Series arrays are the most compact chip-on-board devices across

all of Bridgelux's LED Array products. The arrays incorporate several features to simplify design integration and assembly.

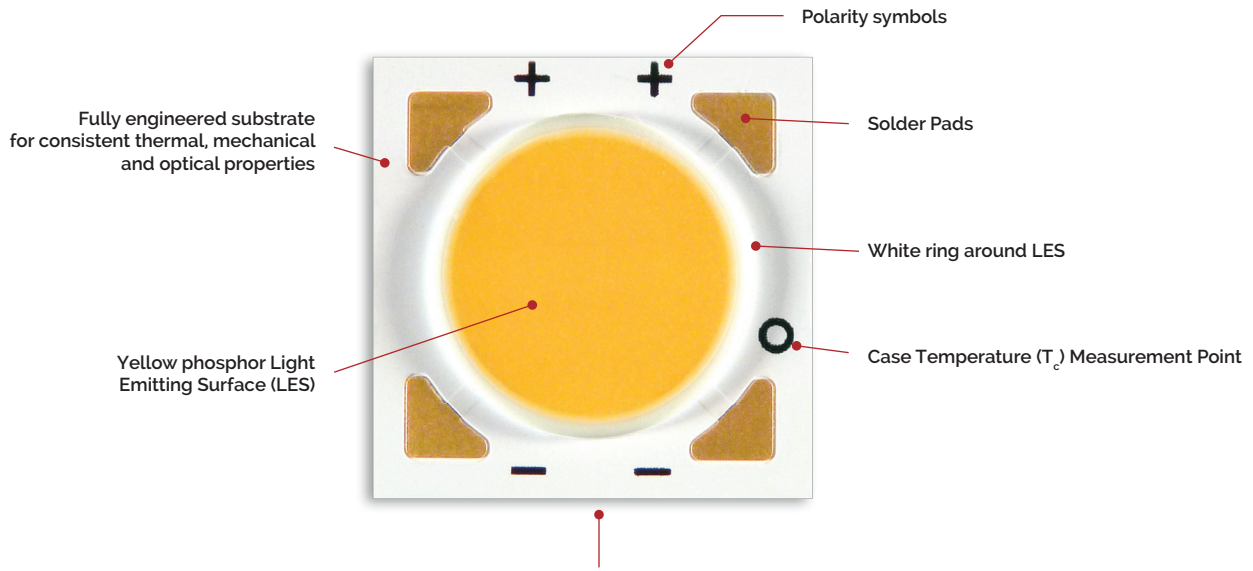

Note: Part number and lot codes are scribed on back of array

Product Nomenclature

The part number designation for Bridgelux V Series LED arrays is explained as follows:

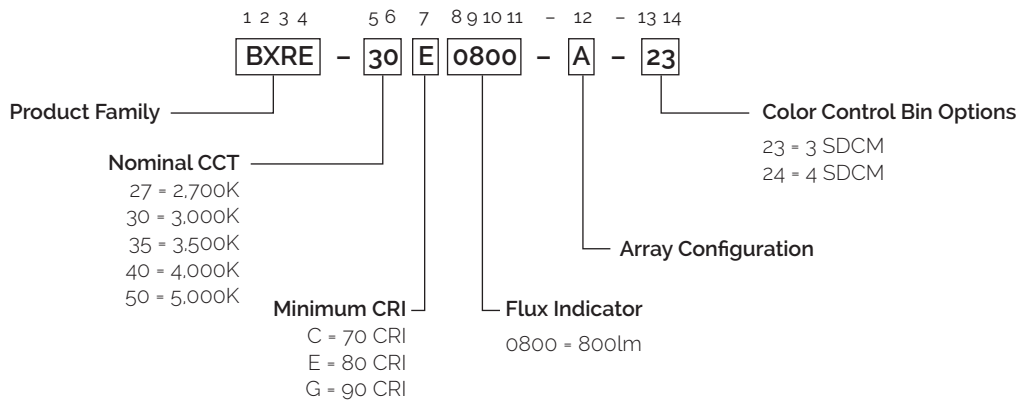

Product Selection Guide

The following product configurations are available:

Table 1: Selection Guide, Pulsed Measurement Data ($T_j = T_c = 25^\circ\text{C}$)

Part Number	Nominal CCT ¹ (K)	CRI ²	Nominal Drive Current ³ (mA)	Typical Pulsed Flux ^{4,5,6} $T_c = 25^\circ\text{C}$ (lm)	Minimum Pulsed Flux ^{6,7} $T_c = 25^\circ\text{C}$ (lm)	Typical V_f (V)	Typical Power (W)	Typical Efficacy (lm/W)
BXRE-27E0800-A-2x	2700	80	175	742	699	35.6	6.2	119
BXRE-27E0800-B-2x	2700	80	350	742	699	17.8	6.2	119
BXRE-27G0800-A-2x	2700	90	175	642	600	35.6	6.2	103
BXRE-27G0800-B-2x	2700	90	350	642	600	17.8	6.2	103
BXRE-30E0800-A-2x	3000	80	175	785	708	35.6	6.2	126
BXRE-30E0800-B-2x	3000	80	350	785	708	17.8	6.2	126
BXRE-30G0800-A-2x	3000	90	175	657	617	35.6	6.2	105
BXRE-30G0800-B-2x	3000	90	350	657	617	17.8	6.2	105
BXRE-35E0800-A-2x	3500	80	175	807	736	35.6	6.2	130
BXRE-35E0800-B-2x	3500	80	350	807	736	17.8	6.2	130
BXRE-35G0800-A-2x	3500	90	175	679	595	35.6	6.2	109
BXRE-35G0800-B-2x	3500	90	350	679	595	17.8	6.2	109
BXRE-40E0800-A-2x	4000	80	175	831	772	35.6	6.2	133
BXRE-40E0800-B-2x	4000	80	350	831	772	17.8	6.2	133
BXRE-40G0800-A-2x	4000	90	175	724	632	35.6	6.2	116
BXRE-40G0800-B-2x	4000	90	350	724	632	17.8	6.2	116
BXRE-50C0800-A-24	5000	70	175	896	834	35.6	6.2	144
BXRE-50C0800-B-24	5000	70	350	896	834	17.8	6.2	144
BXRE-50E0800-A-24	5000	80	175	853	811	35.6	6.2	137
BXRE-50E0800-B-24	5000	80	350	853	811	17.8	6.2	137

Table 2: Selection Guide, Stabilized DC Performance ($T_c = 85^\circ\text{C}$)^{8,9}

Part Number	Nominal CCT ¹ (K)	CRI ²	Nominal Drive Current ³ (mA)	Typical DC Flux $T_c = 85^\circ\text{C}$ (lm)	Minimum DC Flux ¹⁰ $T_c = 85^\circ\text{C}$ (lm)	Typical V_f (V)	Typical Power (W)	Typical Efficacy (lm/W)
BXRE-27E0800-A-2x	2700	80	175	666	628	34.6	6.1	110
BXRE-27E0800-B-2x	2700	80	350	666	628	17.4	6.1	110
BXRE-27G0800-A-2x	2700	90	175	565	528	34.6	6.1	93
BXRE-27G0800-B-2x	2700	90	350	565	528	17.4	6.1	93
BXRE-30E0800-A-2x	3000	80	175	703	634	34.6	6.1	116
BXRE-30E0800-B-2x	3000	80	350	703	634	17.4	6.1	116
BXRE-30G0800-A-2x	3000	90	175	578	543	34.6	6.1	96
BXRE-30G0800-B-2x	3000	90	350	578	543	17.4	6.1	96
BXRE-35E0800-A-2x	3500	80	175	723	659	34.6	6.1	119
BXRE-35E0800-B-2x	3500	80	350	723	659	17.4	6.1	119
BXRE-35G0800-A-2x	3500	90	175	598	524	34.6	6.1	99
BXRE-35G0800-B-2x	3500	90	350	598	524	17.4	6.1	99
BXRE-40E0800-A-2x	4000	80	175	749	696	34.6	6.1	124
BXRE-40E0800-B-2x	4000	80	350	749	696	17.4	6.1	124
BXRE-40G0800-A-2x	4000	90	175	637	556	34.6	6.1	105
BXRE-40G0800-B-2x	4000	90	350	637	556	17.4	6.1	105
BXRE-50C0800-A-24	5000	70	175	788	734	34.6	6.1	130
BXRE-50C0800-B-24	5000	70	350	788	734	17.4	6.1	130
BXRE-50E0800-A-24	5000	80	175	751	714	34.6	6.1	124
BXRE-50E0800-B-24	5000	80	350	751	714	17.4	6.1	124

Notes for Tables 1 & 2:

- Nominal CCT as defined by ANSI C78.377-2011.
- CRI Values are minimums. Minimum Rg value for 80 CRI products is 0, the minimum Rg values for 90 CRI products is 50.
- Drive current is referred to as nominal drive current.
- Products tested under pulsed condition (10ms pulse width) at nominal test current where T_j (junction temperature) - T_c (case temperature) = 25°C .
- Typical performance values are provided as a reference only and are not a guarantee of performance.
- Bridgelux maintains a $\pm 7\%$ tolerance on flux measurements.
- Minimum flux values at the nominal test current are guaranteed by 100% test.
- Typical stabilized DC performance values are provided as reference only and are not a guarantee of performance.
- Typical performance is estimated based on operation under DC (direct current) with LED array mounted onto a heat sink with thermal interface material and the case temperature maintained at 85°C . Based on Bridgelux test setup, values may vary depending on the thermal design of the luminaire and/or the exposed environment to which the product is subjected.
- Minimum flux values at elevated temperatures are provided for reference only and are not guaranteed by 100% production testing. Based on Bridgelux test setup, values may vary depending on the thermal design of the luminaire and/or the exposed environment to which the product is subjected.

Performance at Commonly Used Drive Currents

V Series LED arrays are tested to the specifications shown using the nominal drive currents in Table 1. V Series may also be driven at other drive currents dependent on specific application design requirements. The performance at any drive current can be derived from the current vs. voltage characteristics shown in Figures 1 & 2 and the flux vs. current characteristics shown in Figures 3 & 4. The performance at commonly used drive currents is summarized in Table 3.

Table 3: Product Performance at Commonly Used Drive Currents

Part Number	CRI	Drive Current ¹ (mA)	Typical V_f $T_c = 25^\circ\text{C}$ (V)	Typical Power $T_c = 25^\circ\text{C}$ (W)	Typical Flux ² $T_c = 25^\circ\text{C}$ (lm)	Typical DC Flux ³ $T_c = 85^\circ\text{C}$ (lm)	Typical Efficacy $T_c = 25^\circ\text{C}$ (lm/W)
BXRE-27E0800-A-2x	80	175	35.6	6.2	742	666	119
		250	36.7	9.2	998	895	109
		350	38.1	13.3	1288	1151	97
BXRE-27E0800-B-2x	80	175	16.9	3.0	396	358	134
		350	17.8	6.2	742	666	119
		500	18.4	9.2	998	895	108
BXRE-27G0800-A-2x	90	175	16.9	3.0	343	304	116
		350	17.8	6.2	642	565	103
		500	18.4	9.2	863	759	94
BXRE-27G0800-B-2x	90	700	19.2	13.4	1115	976	83
		175	35.6	6.2	642	565	103
		250	36.7	9.2	863	759	94
BXRE-30E0800-A-2x	80	350	38.1	13.3	1363	1215	102
		175	35.6	6.2	785	703	126
		250	36.7	9.2	1056	945	115
BXRE-30E0800-B-2x	80	700	19.2	13.4	1363	1215	101
		350	17.8	6.2	785	703	126
		500	18.4	9.2	1056	945	115
		175	16.9	3.0	419	378	142
BXRE-30G0800-A-2x	90	175	35.6	6.2	657	578	105
		250	36.7	9.2	883	777	96
		350	38.1	13.3	1141	998	86

Notes for Table 3:

1. Alternate drive currents in Table 3 are provided for reference only and are not a guarantee of performance.
2. Bridgelux maintains a $\pm 7\%$ tolerance on flux measurements.
3. Typical stabilized DC performance values are provided as reference only and are not a guarantee of performance.

Performance at Commonly Used Drive Currents

Table 3: Product Performance at Commonly Used Drive Currents (Continued)

Part Number	CRI	Drive Current ¹ (mA)	Typical V_f $T_c = 25^\circ\text{C}$ (V)	Typical Power $T_c = 25^\circ\text{C}$ (W)	Typical Flux ² $T_c = 25^\circ\text{C}$ (lm)	Typical DC Flux ³ $T_c = 85^\circ\text{C}$ (lm)	Typical Efficacy $T_c = 25^\circ\text{C}$ (lm/W)
BXRE-30G0800-B-03	90	175	16.9	3.0	351	311	119
		350	17.8	6.2	657	578	105
		500	18.4	9.2	883	777	96
		700	19.2	13.4	1141	998	85
BXRE-35E0800-A-2x	80	175	35.6	6.2	807	723	130
		250	36.7	9.2	1085	972	118
		350	38.1	13.3	1401	1249	105
BXRE-35E0800-B-2x	80	175	16.9	3.0	431	389	146
		350	17.8	6.2	807	723	130
		500	18.4	9.2	1085	972	118
		700	19.2	13.4	1401	1249	104
BXRE-35G0800-A-2x	90	175	35.6	6.2	679	598	109
		250	36.7	9.2	913	803	100
		350	38.1	13.3	1179	1032	88
BXRE-35G0800-B-03	90	175	16.9	3.0	362	321	123
		350	17.8	6.2	679	598	109
		500	18.4	9.2	913	803	99
		700	19.2	13.4	1179	1032	88
BXRE-40E0800-A-24	80	175	35.6	6.2	831	749	133
		250	36.7	9.2	1117	1006	122
		350	38.1	13.3	1443	1293	108
BXRE-40E0800-B-2x	80	175	16.9	3.0	444	403	150
		350	17.8	6.2	831	749	133
		500	18.4	9.2	1117	1006	121
		700	19.2	13.4	1443	1293	107

Notes for Table 3:

1. Alternate drive currents in Table 3 are provided for reference only and are not a guarantee of performance.
2. Bridgelux maintains a $\pm 7\%$ tolerance on flux measurements.
3. Typical stabilized DC performance values are provided as reference only and are not a guarantee of performance.

Performance at Commonly Used Drive Currents

Table 3: Product Performance at Commonly Used Drive Currents (Continued)

Part Number	CRI	Drive Current ¹ (mA)	Typical V_f $T_c = 25^\circ\text{C}$ (V)	Typical Power $T_c = 25^\circ\text{C}$ (W)	Typical Flux ² $T_c = 25^\circ\text{C}$ (lm)	Typical DC Flux ³ $T_c = 85^\circ\text{C}$ (lm)	Typical Efficacy $T_c = 25^\circ\text{C}$ (lm/W)
BXRE-40G0800-A-2x	90	175	35.6	6.2	724	637	116
		250	36.7	9.2	974	856	106
		350	38.1	13.3	1257	1100	94
BXRE-40G0800-B-2x	90	175	16.9	3.0	386	343	131
		350	17.8	6.2	724	637	116
		500	18.4	9.2	974	856	106
		700	19.2	13.4	1257	1100	94
BXRE-50C0800-A-24	70	175	35.6	6.2	896	788	144
		250	36.7	9.2	1205	1060	131
		350	38.1	13.3	1555	1362	117
BXRE-50C0800-B-24	70	175	16.9	3.0	478	424	162
		350	17.8	6.2	896	788	144
		500	18.4	9.2	1205	1060	131
		700	19.2	13.4	1555	1362	116
BXRE-50E0800-A-24	80	175	35.6	6.2	853	751	137
		250	36.7	9.2	1147	1009	125
		350	38.1	13.3	1481	1296	111
BXRE-50E0800-B-24	80	175	16.9	3.0	455	404	154
		350	17.8	6.2	853	751	137
		500	18.4	9.2	1147	1009	125
		700	19.2	13.4	1481	1296	110

Notes for Table 3:

1. Alternate drive currents in Table 3 are provided for reference only and are not a guarantee of performance.
2. Bridgelux maintains a $\pm 7\%$ tolerance on flux measurements.
3. Typical stabilized DC performance values are provided as reference only and are not a guarantee of performance.

Electrical Characteristics

Table 4: Electrical Characteristics

Part Number	Drive Current (mA)	Forward Voltage Pulsed, $T_c = 25^\circ\text{C}$ (V) ^{1,2}			Typical Coefficient of Forward Voltage ³ $\Delta V_f / \Delta T_c$ (mV/ $^\circ\text{C}$)	Typical Thermal Resistance Junction to Case ⁴ R_{j-c} ($^\circ\text{C}/\text{W}$)	Driver Selection Voltages ⁵ (V)	
		Minimum	Typical	Maximum			V_f Min. Hot $T_c = 105^\circ\text{C}$ (V)	V_f Max. Cold $T_c = -40^\circ\text{C}$ (V)
BXRE-xxx0800-A-2x	175	32.9	35.6	38.3	-17	0.71	31.5	39.4
	350	35.1	38.1	41.4	-17	0.81	33.7	42.5
BXRE-xxx0800-B-2x	350	16.5	17.8	19.2	-7	0.71	15.9	19.7
	700	17.7	19.3	20.8	-7	0.81	17.1	21.3

Notes for Table 4:

- Parts are tested in pulsed conditions, $T_c = 25^\circ\text{C}$. Pulse width is 10ms.
- Voltage minimum and maximum are provided for reference only and are not a guarantee of performance.
- Bridgelux maintains a tester tolerance of $\pm 0.10\text{V}$ on forward voltage measurements.
- Typical coefficient of forward voltage tolerance is $\pm 0.1\text{mV}$ for nominal current.
- Thermal resistance values are based from test data of a 3000K 80 CRI product.
- Thermal resistance value was calculated using total electrical input power; optical power was not subtracted from input power. The thermal interface material used during testing is not included in the thermal resistance value.
- V_f min hot and max cold values are provided as reference only and are not guaranteed by test. These values are provided to aid in driver design and selection over the operating range of the product.

Absolute Maximum Ratings

Table 5: Maximum Ratings

Parameter	Maximum Rating	
	LED Junction Temperature (T_j)	150°C
Storage Temperature	-40°C to +105°C	
Operating Case Temperature ¹ (T_c)	105°C	
Soldering Temperature ²	350°C or lower for a maximum of 10 seconds	
	BXRE-xxx0800-A-2x	BXRE-xxx0800-B-2x
Maximum Drive Current ^{3,4,5}	350 mA	700 mA
Maximum Peak Pulsed Drive Current ⁶	500 mA	1000mA
Maximum Reverse Voltage ⁷	-60 V	-30 V

Notes for Table 5:

1. For IEC 62717 requirement, please consult your Bridgelux sales representative.
2. Refer to Bridgelux Application Note AN41: Assembly Considerations for Bridgelux V Series LED Arrays.
3. DC Forward Current for LM-80 is the maximum drive current for which LM-80 data is currently available.
4. Lumen maintenance (L70) and lifetime predictions are valid for drive current and case temperature conditions used for LM-80 testing as included in the applicable LM-80 test report for these arrays. Contact your Bridgelux sales representatives for LM-80 report.
5. Arrays may be driven at higher currents however lumen maintenance may be reduced.
6. Bridgelux recommends a maximum duty cycle of 10% and pulse width of 20 ms when operating LED Arrays at maximum peak pulsed current specified. Maximum peak pulsed currents indicate values where LED Arrays can be driven without catastrophic failures.
7. Light emitting diodes are not designed to be driven in reverse voltage and will not produce light under this condition. Maximum rating provided for reference only.

Performance Curves

Figure 1: Drive Current vs. Voltage ($T_j=T_c=25^\circ\text{C}$) – BXRE-xxx0800-A-2x

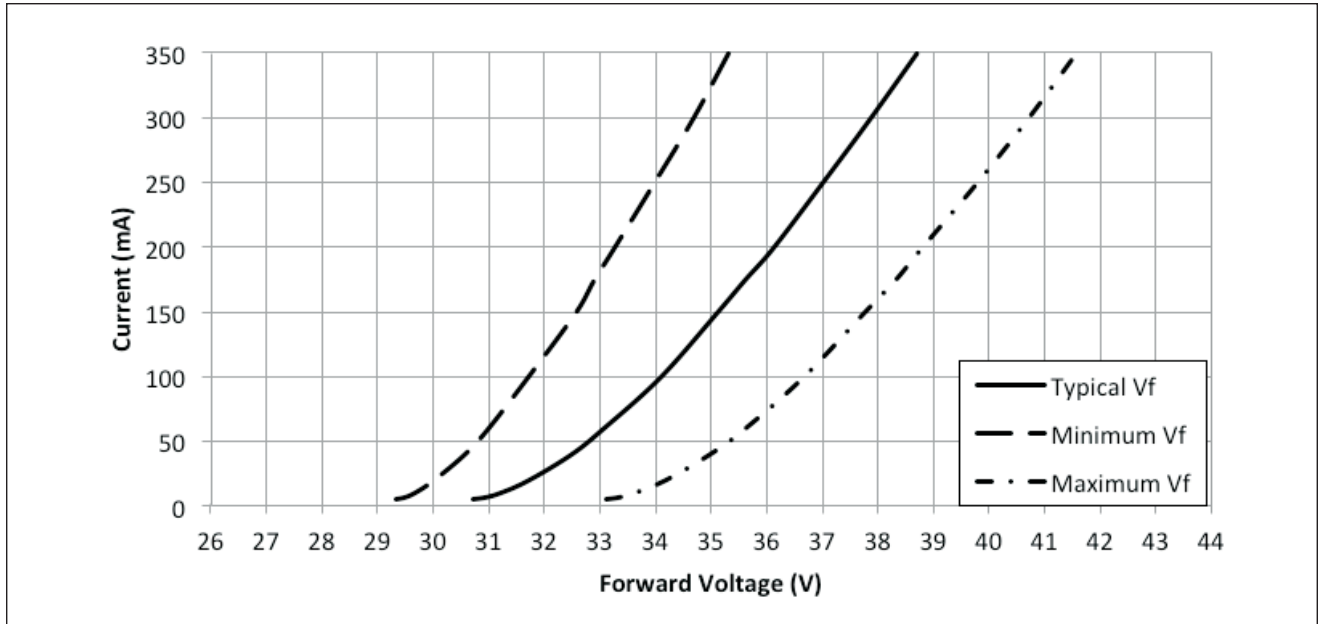
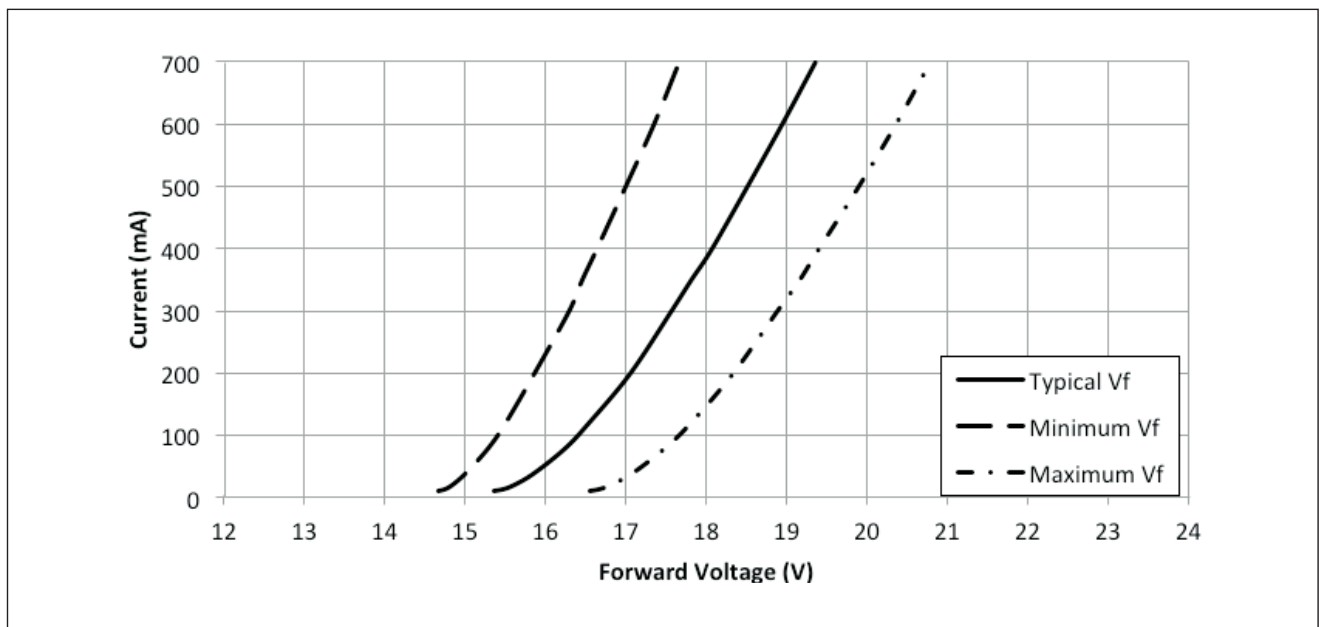

Figure 2: Drive Current vs. Voltage ($T_j=T_c=25^\circ\text{C}$) – BXRE-xxx0800-B-2x



Performance Curves

Figure 3: Typical Relative Luminous Flux vs. Current – BXRE-xxx0800-A-2x

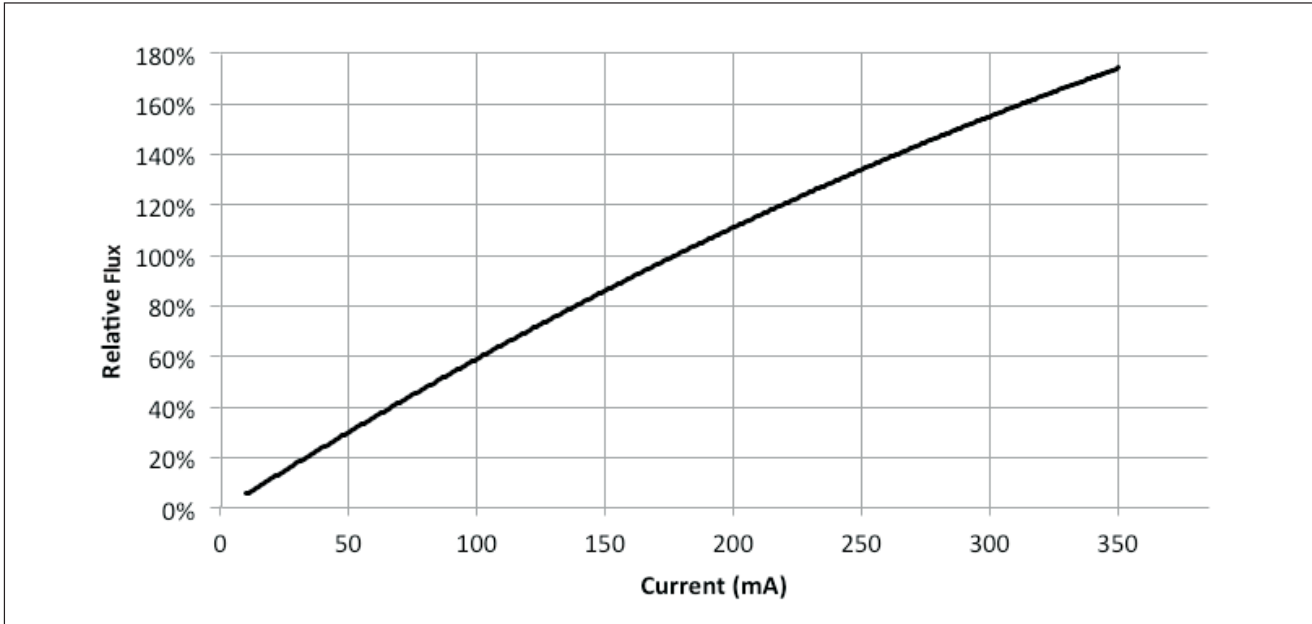
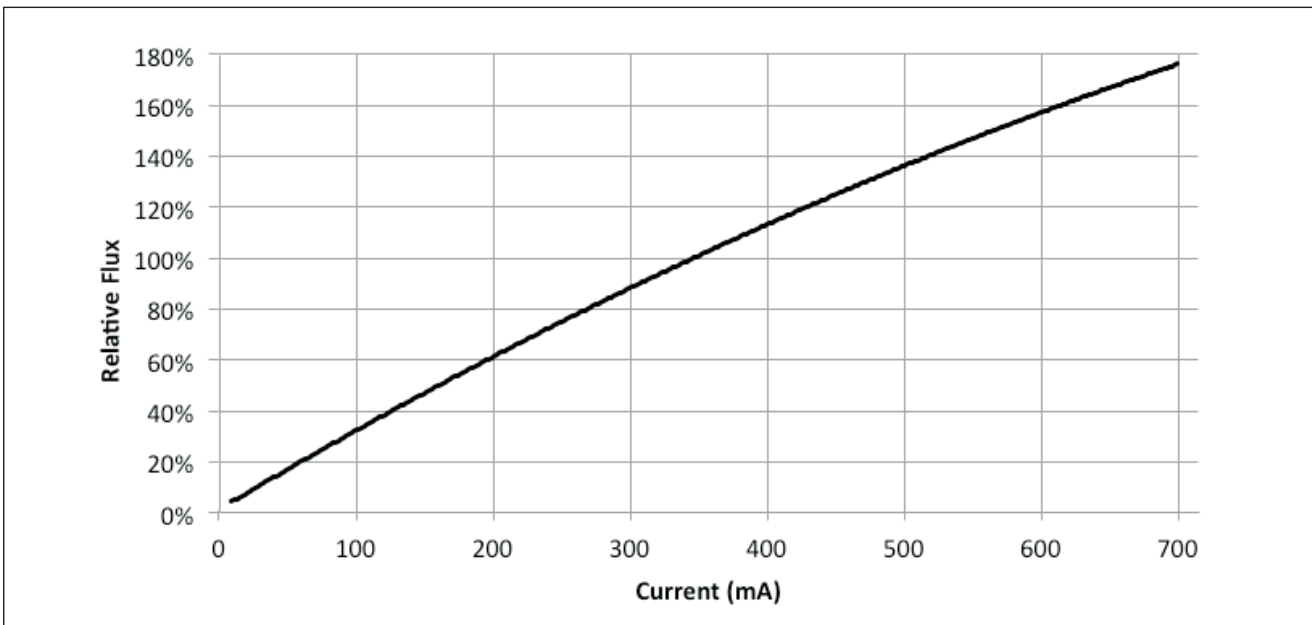

Figure 4: Typical Relative Luminous Flux vs. Current – BXRE-xxx0800-B-2x



Note for Figures 3-4:

1. Bridgelux does not recommend driving high power LEDs at low currents. Doing so may produce unpredictable results. Pulse width modulation (PWM) is recommended for dimming effects.

Performance Curves

Figure 5: Typical DC Flux vs. Case Temperature

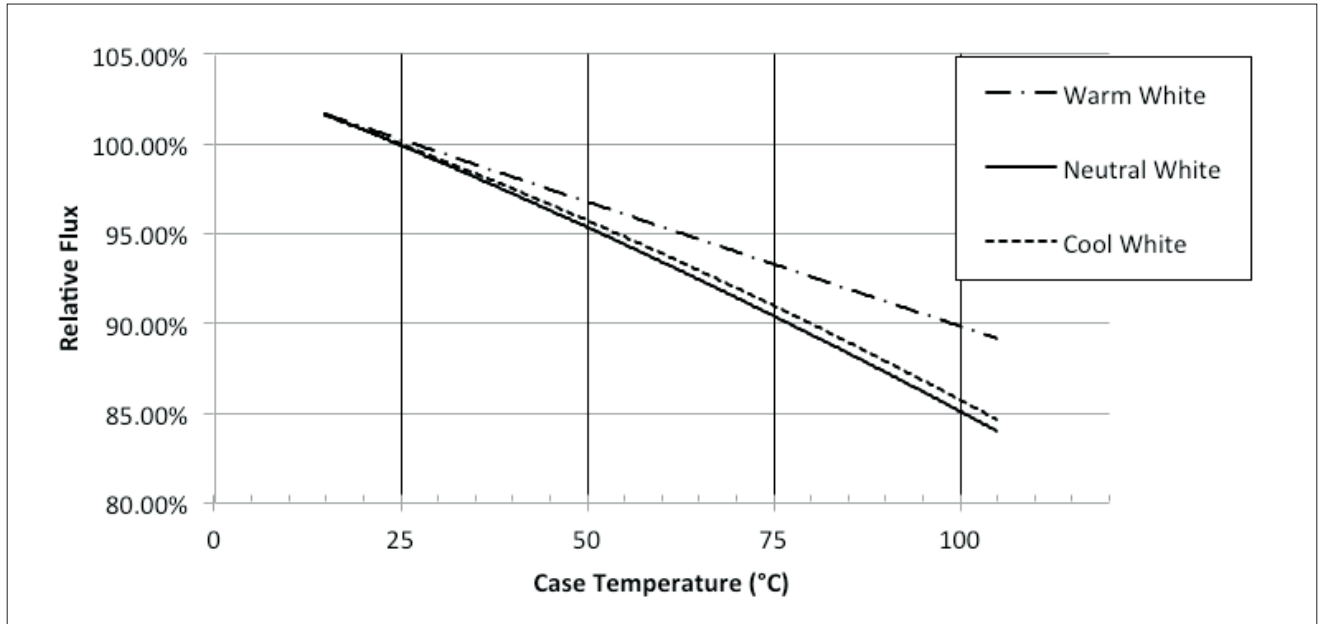
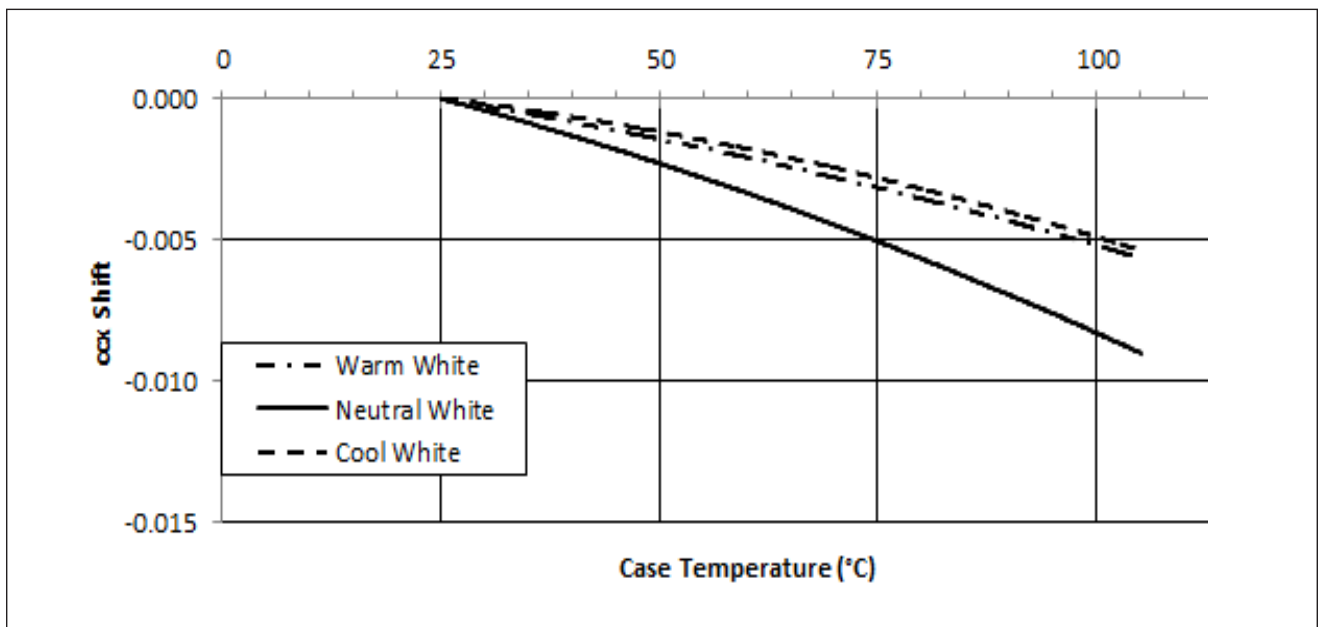

Figure 6: Typical DC cxx Shift vs. Case Temperature



Notes for Figures 5-6:

1. Characteristics shown for warm white based on 3000K and 80 CRI.
2. Characteristics shown for neutral white based on 4000K and 80 CRI.
3. Characteristics shown for cool white based on 5000K and 70 CRI.
4. For other color SKUs, the shift in color will vary. Please contact your Bridgelux Sales Representative for more information.

Performance Curves

Figure 7: Typical DC ccy Shift vs. Case Temperature

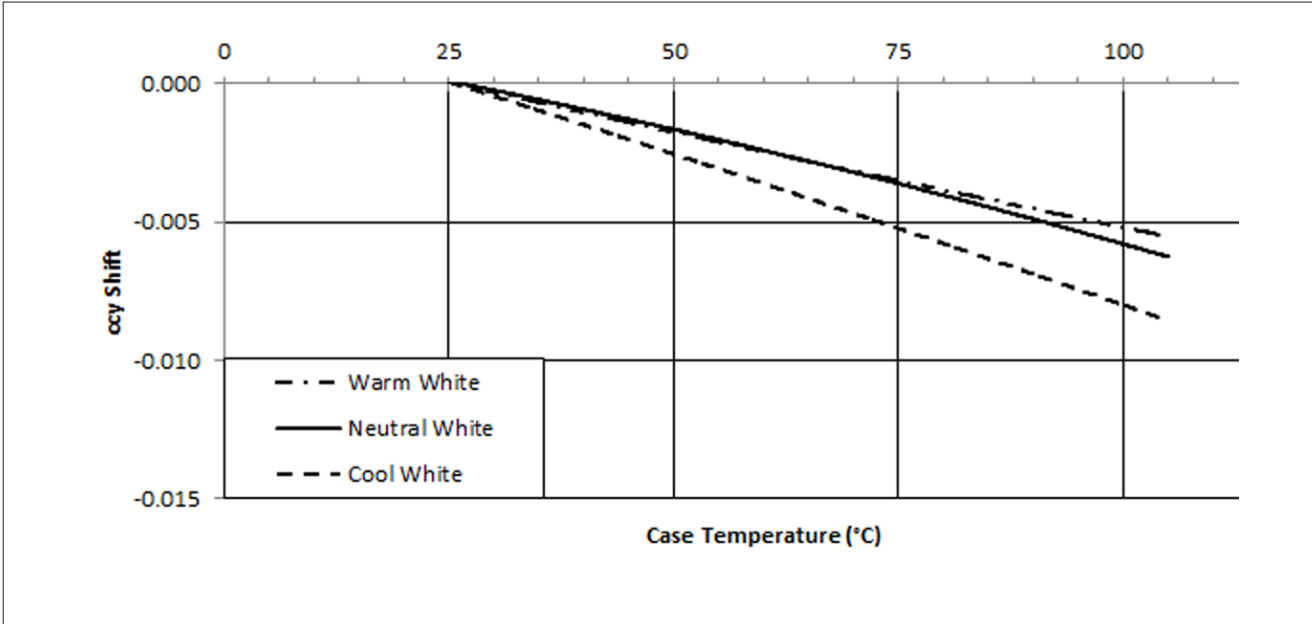

Notes for Figure 7:

- 1. Characteristics shown for warm white based on 3000K and 80 CRI.
- 2. Characteristics shown for neutral white based on 4000K and 80 CRI.
- 3. Characteristics shown for cool white based on 5000K and 70 CRI.
- 4. For other color SKUs, the shift in color will vary. Please contact your Bridgelux Sales Representative for more information.

Typical Radiation Pattern

Figure 8: Typical Spatial Radiation Pattern

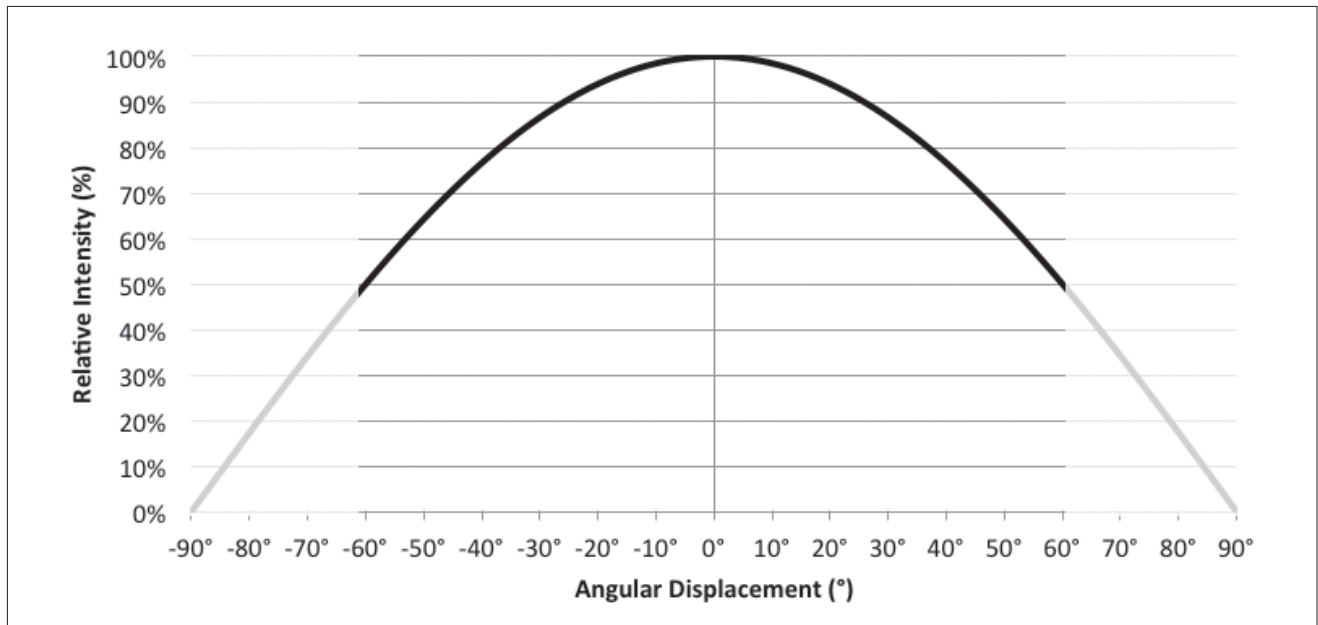

Notes for Figure 8:

1. Typical viewing angle is 120°.
2. The viewing angle is defined as the off axis angle from the centerline where I_v is $\frac{1}{2}$ of the peak value.

Figure 9: Typical Polar Radiation Pattern

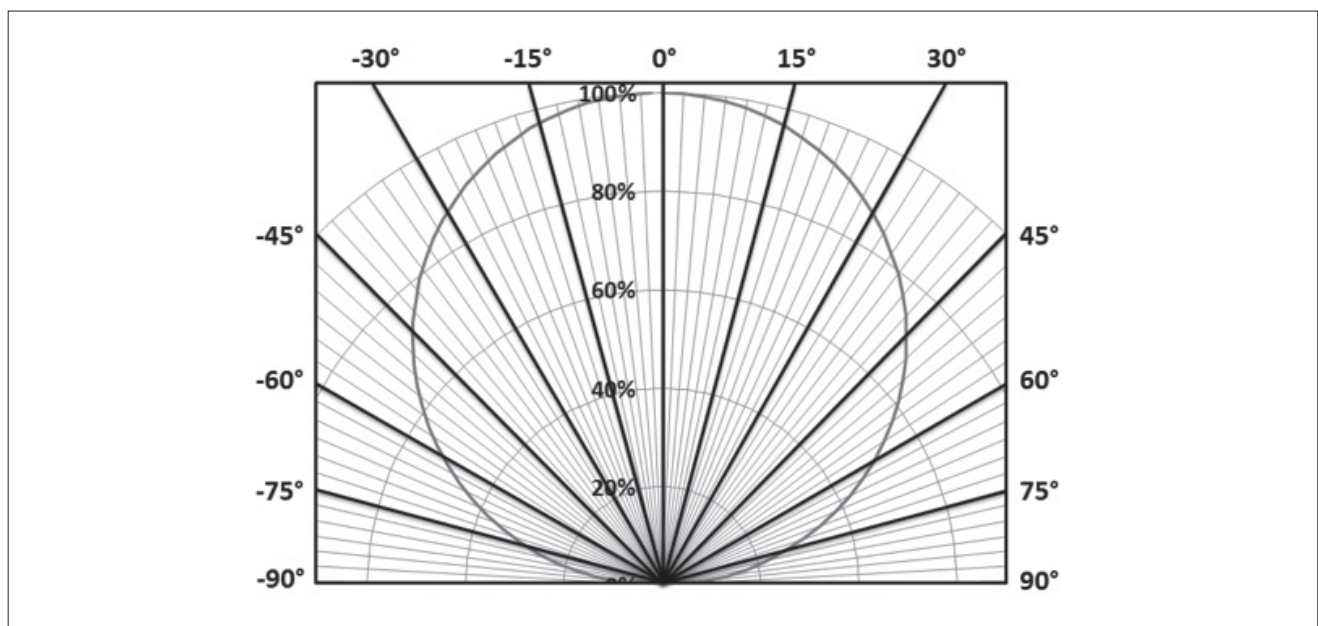

Typical Color Spectrum

Figure 10: Typical Color Spectrum

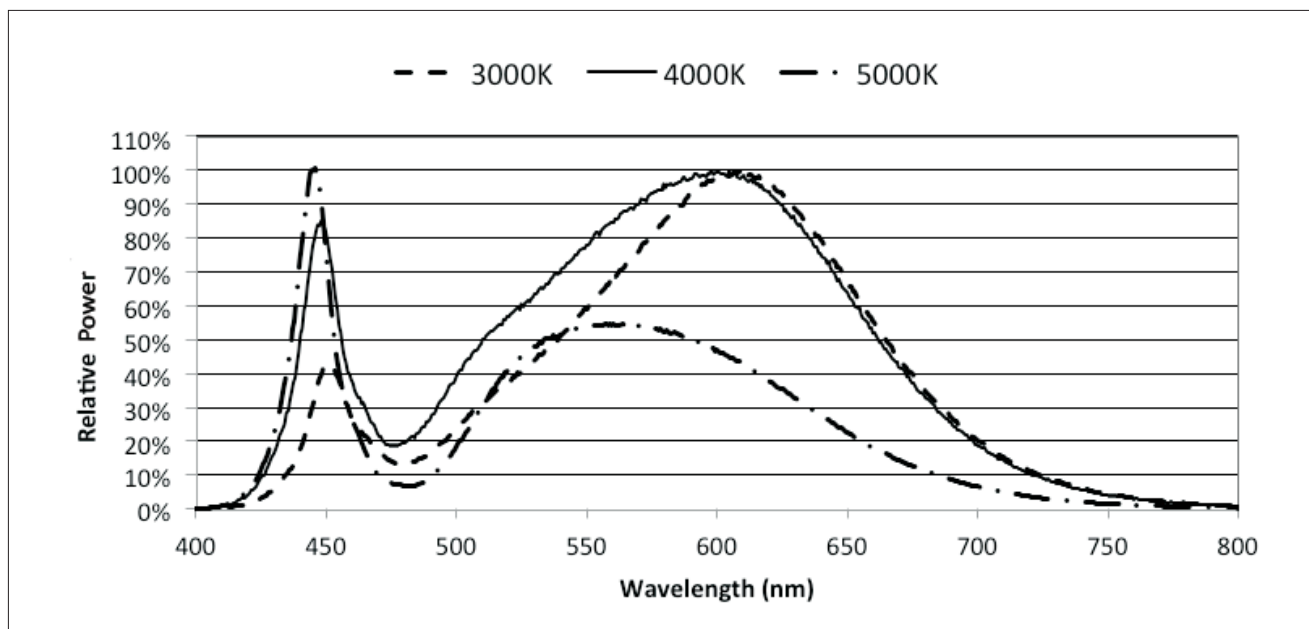

Notes for Figure 10:

1. Color spectra measured at nominal current for $T_j = T_c = 25^\circ\text{C}$.
2. Color spectra shown for warm white is 3000K and 80 CRI.
3. Color spectra shown for neutral white is 4000K and 80 CRI.
4. Color spectra shown for cool white is 5000K and 70 CRI.

Color Binning Information

Figure 12: Graph of Warm and Neutral White Test Bins in xy Color Space

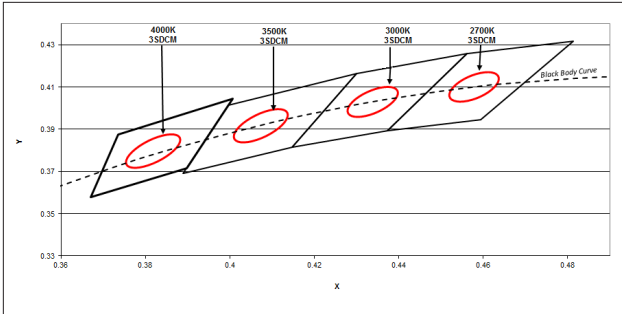

Note: Pulsed Test Conditions, $T_c = 25^\circ\text{C}$

Table 6: Warm and Neutral White xy Bin Coordinates and Associated Typical CCT

Bin Code	2700K	3000K	3500K	4000K
ANSI Bin (for reference only)	(2580K - 2870K)	(2870K - 3220K)	(3220K - 3710K)	(3710K - 4260K)
23 (3SDCM)	(2651K - 2794K)	(2968K - 3136K)	(3369K - 3586K)	(3851K - 4130K)
Center Point (x,y)	(0.4578, 0.4101)	(0.4338, 0.403)	(0.4073, 0.3917)	(0.3818, 0.3797)

Figure 13: Graph of Cool White Test Bins in xy Color Space

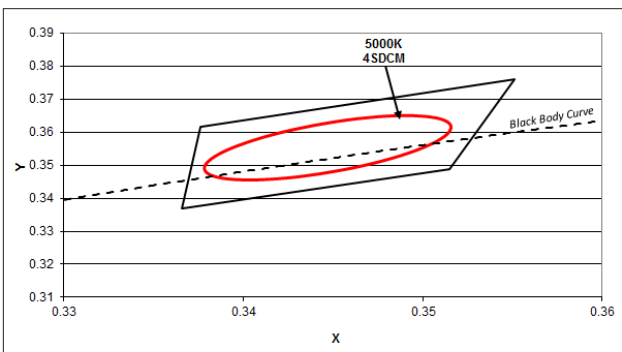

Note: Pulsed Test Conditions, $T_c = 25^\circ\text{C}$

Table 7: Cool White xy Bin Coordinates and Associated Typical CCT

Bin Code	5000K
ANSI Bin (for reference only)	(4745K - 5311K)
24 (4SDCM)	(4801K - 5282K)
Center Point (x,y)	(0.3447, 0.3553)

Packaging and Labeling

Figure 14: Drawing for V8 Packaging Tray

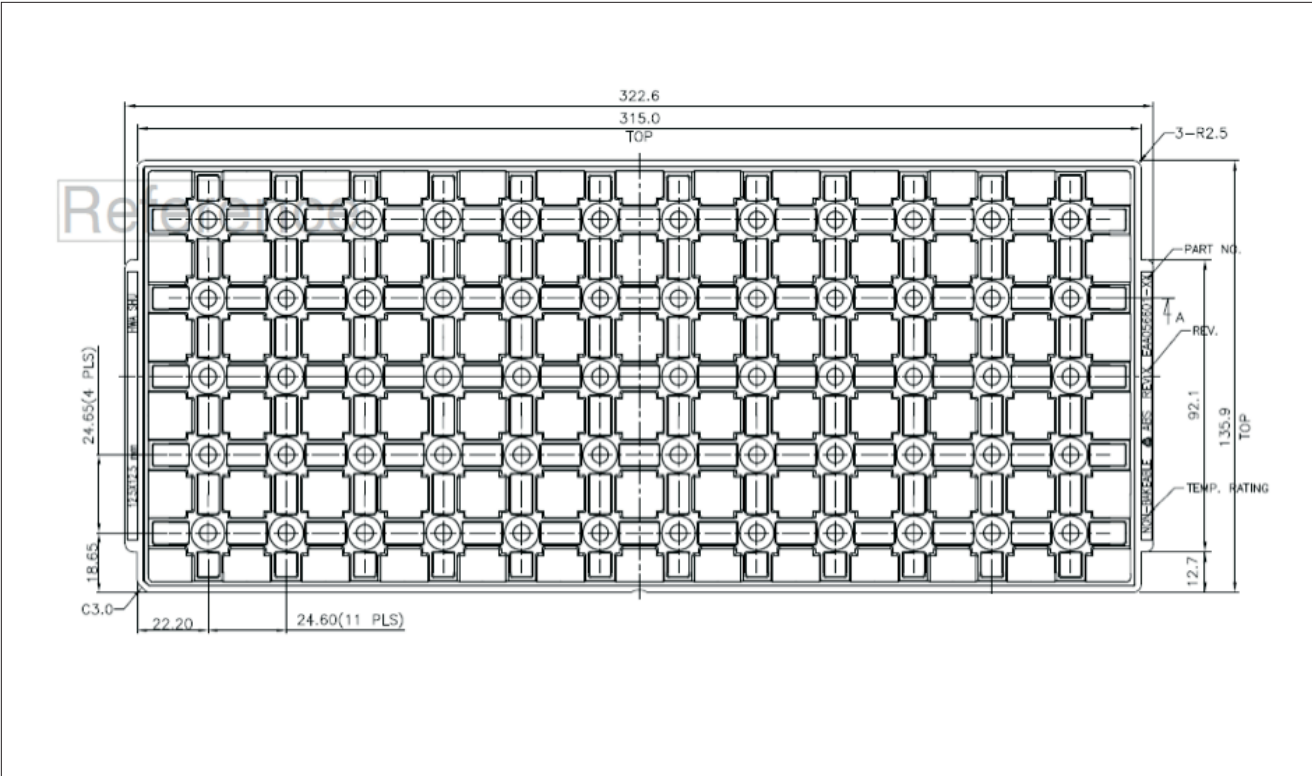

Notes for Figure 14:

1. Dimensions are in millimeters
2. Tolerances: XX = ± 0.25, XXX = ± 0.13, X'o' = ±0'30'
3. Trays are stackable without interference and will not stick together during unstacking operation

Packaging and Labeling

Figure 15: V Series Packaging and Labeling

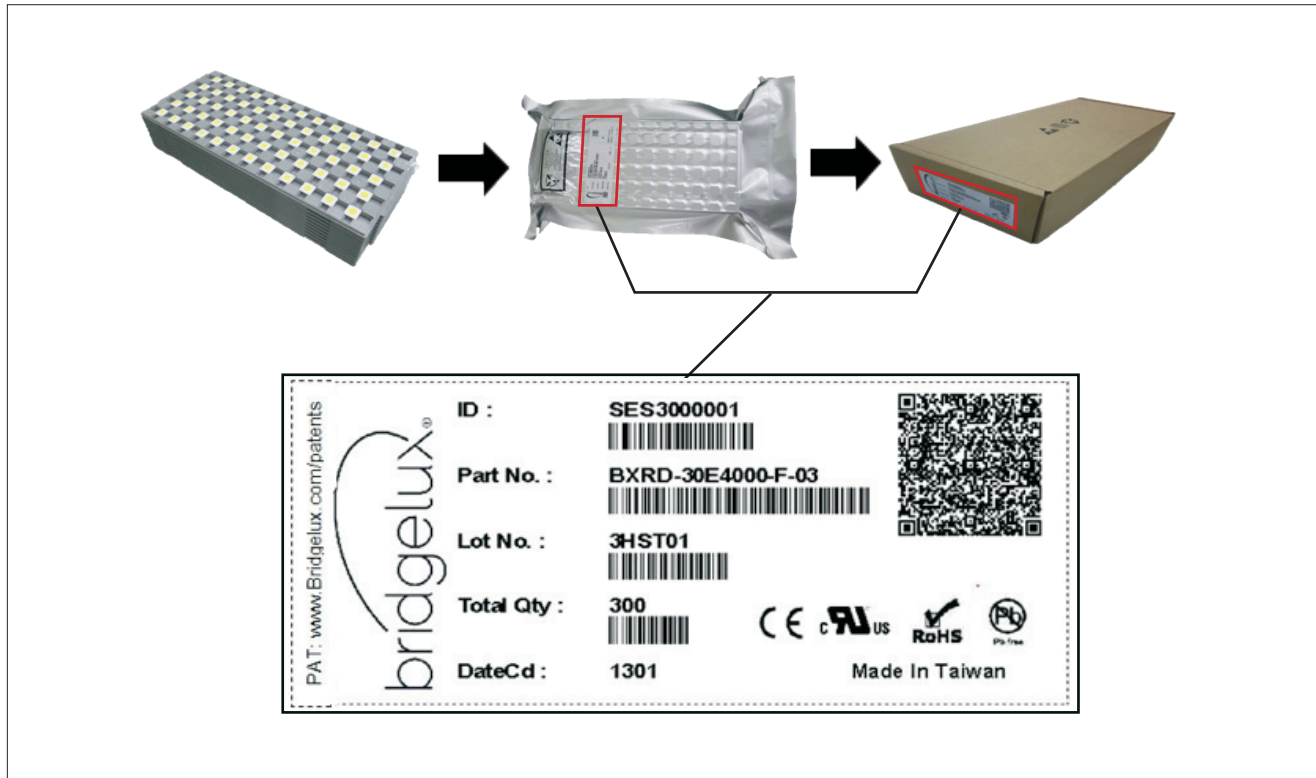

Notes for Figure 15:

1. Each tray holds 60 COB arrays, 10 trays are stacked and one empty tray placed on top to cover the top tray.
2. Stacked trays are to contain only 1 part number and be vacuum sealed in an anti-static bag and placed in its own individual box.
3. Each bag and box is to be labeled as shown above.

Figure 16: Product Labeling

Bridgelux COB arrays have laser markings on the back side of the substrate to help with product identification. In addition to the product identification markings, Bridgelux COB arrays also contain markings for internal Bridgelux manufacturing use only. The image below shows which markings are for customer use and which ones are for Bridgelux internal use only. The Bridgelux internal manufacturing markings are subject to change without notice, however these will not impact the form, function or performance of the COB array.



Design Resources

Application Notes

Bridgelux has developed a comprehensive set of application notes and design resources to assist customers in successfully designing with the V Series product family of LED array products. For a list of resources under development, visit www.bridgelux.com.

Optical Source Models

Optical source models and ray set files are available for all Bridgelux products. For a list of available formats, visit www.bridgelux.com.

3D CAD Models

Three dimensional CAD models depicting the product outline of all Bridgelux V Series LED arrays are available in both IGS and STEP formats. Please contact your Bridgelux sales representative for assistance.

Precautions

CAUTION: CHEMICAL EXPOSURE HAZARD

Exposure to some chemicals commonly used in luminaire manufacturing and assembly can cause damage to the LED array. Please consult Bridgelux Application Note AN41 for additional information.

CAUTION: EYE SAFETY

Eye safety classification for the use of Bridgelux V Series LED arrays is in accordance with IEC specification EN62471: Photobiological Safety of Lamps and Lamp Systems. V Series LED arrays are classified as Risk Group 1 (Low Risk) when operated at or below the maximum drive current. Please use appropriate precautions. It is important that employees working with LEDs are trained to use them safely.

CAUTION: RISK OF BURN

Do not touch the V Series LED array during operation. Allow the array to cool for a sufficient period of time before handling. The V Series LED array may reach elevated temperatures such that could burn skin when touched.

CAUTION

CONTACT WITH LIGHT EMITTING SURFACE (LES)

Avoid any contact with the LES. Do not touch the LES of the LED array or apply stress to the LES (yellow phosphor resin area). Contact may cause damage to the LED array.

Optics and reflectors must not be mounted in contact with the LES (yellow phosphor resin area). Use the mechanical features of the LED array housing, edges and/or mounting holes to locate and secure optical devices as needed.

Disclaimers

MINOR PRODUCT CHANGE POLICY

The rigorous qualification testing on products offered by Bridgelux provides performance assurance. Slight cosmetic changes that do not affect form, fit, or function may occur as Bridgelux continues product optimization.

STANDARD TEST CONDITIONS

Unless otherwise stated, array testing is performed at the nominal drive current.

About Bridgelux: We Build Light That Transforms

At Bridgelux, we help companies, industries and people experience the power and possibility of light. Since 2002, we've designed LED solutions that are high performing, energy efficient, cost effective and easy to integrate. Our focus is on light's impact on human behavior, delivering products that create better environments, experiences and returns—both experiential and financial. And our patented technology drives new platforms for commercial and industrial luminaires.

For more information about the company, please visit
bridgelux.com
twitter.com/Bridgelux
facebook.com/Bridgelux
WeChat ID: BridgeluxInChina



101 Portola Avenue
Livermore, CA 94551
Tel (925) 583-8400
Fax (925) 583-8410
www.bridgelux.com

© 2016 Bridgelux, Inc. All rights reserved 2016. Product specifications are subject to change without notice. Bridgelux, the Bridgelux stylized logo design and V Series are registered trademarks of Bridgelux, Inc. All other trademarks are the property of their respective owners.

Bridgelux V8 Array Series Product Data Sheet DS41 Rev. F (06/2016)

单击下面可查看定价，库存，交付和生命周期等信息

[>>Bridgelux\(普瑞光电\)](#)