



# Bridgelux® Gen 7 V13 Array Series

Product Data Sheet DS101



# Introduction

V Series



The V Series™ LED Array products deliver high quality light in a compact and cost-effective solid-state lighting package. These chip on board (CoB) arrays can be efficiently driven at twice the nominal drive current, enabling design flexibility not previously possible. This high flux density light source is designed to support a wide range of high quality, low cost directional luminaires and replacement lamps for commercial and residential applications.

The V13 LED Array is available in a variety of electrical, CCT and CRI combinations providing substantial design flexibility and energy efficiencies.

Lighting system designs incorporating these LED arrays deliver increased system level efficacy and longer service life. Typical applications include, replacement lamps, and task, accent, spot, track, wide area, security, wall pack and down lights.

Bridgelux Décor Series is our state of the art color line designed specifically for premium applications, producing unmatched LED light quality with brilliant color-rendering options and offer pleasing and inspiring lighting palettes. Bridgelux Décor Series color points are available on Vero® SE Series, Vero® Series, V Series™ and H Series™.

**Décor Series Class A** is based on human response testing, providing color points with a combined GAI and CRI metric.

**Décor Series™ Ultra** products provide a high CRI of 97 and a minimum R9 value of 93, which emphasizes the reds and color tones to which the human eye is most receptive - perfect for the most luxurious retail shops and world renowned museums. Décor Series Ultra is designed as a replacement for halogen lamps.

**Décor Series™ Street and Landmark** is designed to be a direct replacement for high pressure sodium lamps.

**Décor Series™ Showcase** is the optimal solution for replacing ceramic metal halide lamps, incorporating the same pure white light with enhanced spectrum coverage and higher efficacy.

## Features

- Efficacy of 160 lm/W typical
- Compact high flux density light source
- Uniform high quality illumination
- Minimum 65, 70, 80, 90 and 95 CRI options
- Streamlined thermal path
- ENERGY STAR® / ANSI compliant color binning structure with 2, 3 and 4 SDCM options
- More energy efficient than incandescent, halogen and fluorescent lamps
- Low voltage DC operation
- Instant light with unlimited dimming
- V<sub>f</sub> bin code backside marking

## Benefits

- Enhanced optical control
- Clean white light without pixilation
- High quality true color reproduction
- Significantly reduced thermal resistance and increased operating temperatures
- Uniform consistent white light
- Lower operating costs
- Easy to use with daylight and motion detectors to enable increased energy savings
- Reduced maintenance costs
- Environmentally friendly, no disposal issue



# Contents

Product Feature Map	2
Product Nomenclature	2
Product Selection Guide	3
Performance at Commonly Used Drive Currents	8
Electrical Characteristics	14
Eye Safety	15
Absolute Maximum Ratings	16
Performance Curves	17
Typical Radiation Pattern	20
Typical Color Spectrum	21
Mechanical Dimensions	22
Color Binning Information	23
Packaging and Labeling	24
Design Resources	26
Precautions	26
Disclaimers	26
About Bridgelux	27

# Product Feature Map

Bridgelux arrays are fully engineered devices that provide consistent thermal and optical performance on an engineered mechanical platform. The V Series arrays are the most compact chip-on-board devices across all of

Bridgelux's LED Array products. The arrays incorporate several features to simplify design integration and assembly. Please visit [www.bridgelux.com](http://www.bridgelux.com) for more information on the V Series family of products.

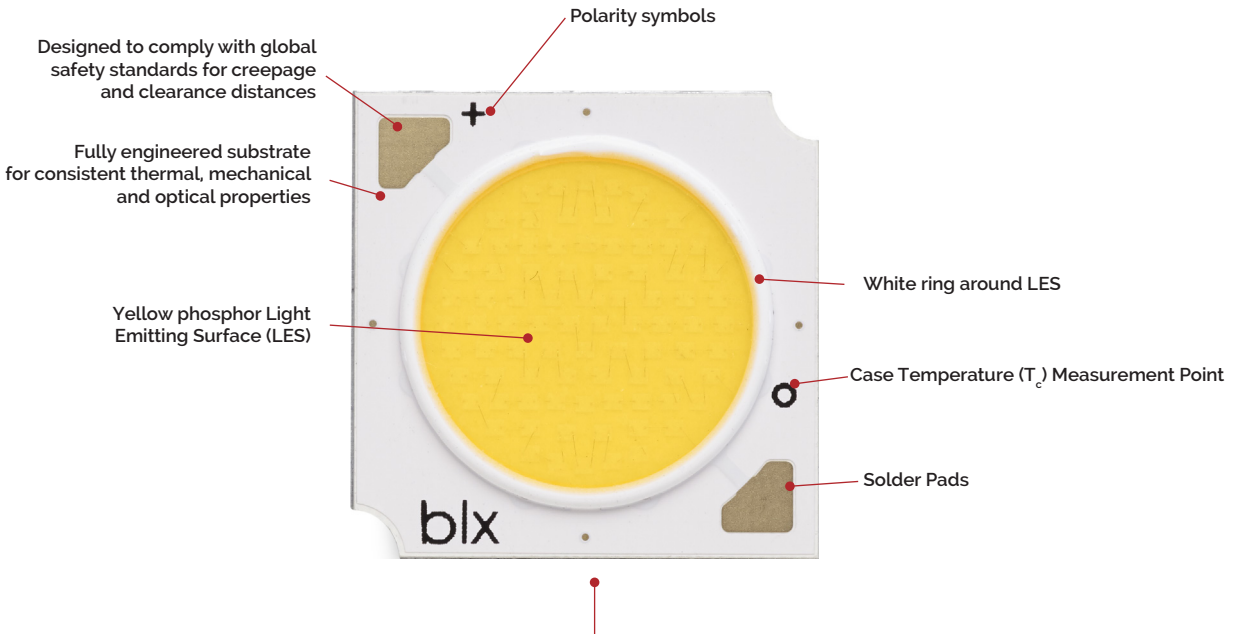

Note: Part number and lot codes are scribed on back of array

## Product Nomenclature

The part number designation for Bridgelux V Series LED arrays is explained as follows:

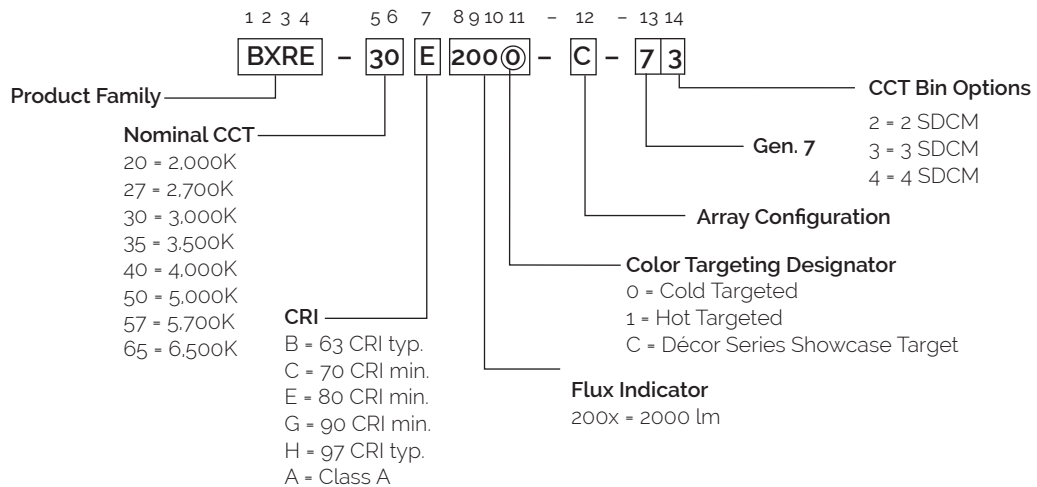

# Product Selection Guide

The following product configurations are available:

**Table 1:** Selection Guide, Pulsed Measurement Data ( $T_j = T_c = 25^\circ\text{C}$ )

Part Number	Nominal CCT <sup>1</sup> (K)	CRI <sup>2</sup>	Nominal Drive Current <sup>3</sup> (mA)	Typical Pulsed Flux <sup>4,5,6</sup> $T_c = 25^\circ\text{C}$ (lm)	Minimum Pulsed Flux <sup>6,7</sup> $T_c = 25^\circ\text{C}$ (lm)	Typical $V_f$ (V)	Typical Power (W)	Typical Efficacy (lm/W)
BXRE-17E2000-C-74	1750	80	630	1939	1745	34.8	21.9	89
BXRE-20B2001-B-73	2000	65	450	2335	1992	34.8	15.6	149
BXRE-20B2001-C-73	2000	65	630	3270	2853	34.8	21.9	149
BXRE-25E2000-C-74	2500	80	630	3134	2821	34.8	21.9	143
BXRE-27E2000-B-7X	2700	80	450	2400	2090	34.8	15.6	153
BXRE-27E2000-C-7X	2700	80	630	3360	2926	34.8	21.9	153
BXRE-27G20H0-B-7X	2700	90	450	2080	1872	34.8	15.6	133
BXRE-27G20H0-C-7X	2700	90	630	2912	2621	34.8	21.9	133
BXRE-27G2000-B-7X	2700	90	450	1997	1797	34.8	15.6	128
BXRE-27G2000-C-7X	2700	90	630	2796	2516	34.8	21.9	128
BXRE-27H2000-B-7X	2700	97	450	1740	1566	34.8	15.6	111
BXRE-30C2001-B-74	3000	70	450	2752	2477	34.8	15.6	176
BXRE-30C2001-C-74	3000	70	630	3853	3468	34.8	21.9	176
BXRE-30E2000-B-7X	3000	80	450	2497	2247	34.8	15.6	160
BXRE-30E2000-C-7X	3000	80	630	3495	3146	34.8	21.9	160
BXRE-30G20H0-B-7X	3000	90	450	2174	1956	34.8	15.6	139
BXRE-30G20H0-C-7X	3000	90	630	3043	2739	34.8	21.9	139
BXRE-30G2000-B-7X	3000	90	450	2078	1870	34.8	15.6	133
BXRE-30G2000-C-7X	3000	90	630	2909	2618	34.8	21.9	133
BXRE-30G200C-B-73	3000	90	450	1933	1740	34.8	15.6	124
BXRE-30G200C-C-73	3000	90	630	2706	2435	34.8	21.9	124
BXRE-30A2001-B-73 <sup>8,9</sup>	3000	93	450	1877	1689	34.8	15.6	120
BXRE-30A2001-C-73 <sup>8,9</sup>	3000	93	630	2627	2364	34.8	21.9	120
BXRE-30H2000-B-7X	3000	97	450	1852	1667	34.8	15.6	118
BXRE-35E2000-B-7X	3500	80	450	2577	2319	34.8	15.6	165
BXRE-35E2000-C-7X	3500	80	630	3608	3247	34.8	21.9	165
BXRE-35G2000-B-7X	3500	90	450	2142	1928	34.8	15.6	137
BXRE-35G2000-C-7X	3500	90	630	2999	2699	34.8	21.9	137
BXRE-35A2001-B-73 <sup>8,9</sup>	3500	93	450	2017	1816	34.8	15.6	129
BXRE-35A2001-C-73 <sup>8,9</sup>	3500	93	630	2824	2542	34.8	21.9	129
BXRE-40C2001-B-74	4000	70	450	2799	2519	34.8	15.6	179
BXRE-40C2001-C-74	4000	70	630	3919	3527	34.8	21.9	179
BXRE-40E2000-B-7X	4000	80	450	2593	2265	34.8	15.6	166
BXRE-40E2000-C-7X	4000	80	630	3630	3170	34.8	21.9	166

Notes for Table 1:

- Nominal CCT as defined by ANSI C78.377-2011. Products with a CCT of 5000K-6500K are hot targeted to  $T_c = 85^\circ\text{C}$ .
- CRI values are typical for Decor Series Ultra, Décor Series Street and Landmark and Decor Series Class A products. CRI values are minimums for all other products. Minimum Rg value for 80 CRI products is 0, the minimum Rg values for 90 CRI products is 50, the minimum Rg values for 97 CRI products is 93. Bridgelux maintains a  $\pm 3$  tolerance on Rg values.
- Drive current is referred to as nominal drive current.
- Products tested under pulsed condition (10ms pulse width) at nominal test current where  $T_j$  (junction temperature) -  $T_c$  (case temperature) =  $25^\circ\text{C}$ .
- Typical performance values are provided as a reference only and are not a guarantee of performance.
- Bridgelux maintains a  $\pm 7\%$  tolerance on flux measurements.
- Minimum flux values at the nominal test current are guaranteed by 100% test.
- Nominal CCT is defined by the Lighting Research Center's Class A definition. The center of the Class A color bin is on the corresponding isothermal line.
- GAI value is 80. To help ensure optimal fixture level performance, GAI is measured at the fixture level, on axis, at a case temperature of  $70^\circ\text{C}$ . GAI may vary depending on fixture design and performance.

# Product Selection Guide

The following product configurations are available:

**Table 1:** Selection Guide, Pulsed Measurement Data ( $T_j = T_c = 25^\circ\text{C}$ )

Part Number	Nominal CCT <sup>1</sup> (K)	CRI <sup>2</sup>	Nominal Drive Current <sup>3</sup> (mA)	Typical Pulsed Flux <sup>4,5,6</sup> $T_c = 25^\circ\text{C}$ (lm)	Minimum Pulsed Flux <sup>6,7</sup> $T_c = 25^\circ\text{C}$ (lm)	Typical $V_f$ (V)	Typical Power (W)	Typical Efficacy (lm/W)
BXRE-40G2000-B-7X	4000	90	450	2223	1938	34.8	15.6	142
BXRE-40G2000-C-7X	4000	90	630	3112	2713	34.8	21.9	142
BXRE-50C2001-B-7X	5000	70	450	2851	2482	34.8	15.6	182
BXRE-50C2001-C-7X	5000	70	630	3991	3475	34.8	21.9	182
BXRE-50E2001-B-7X	5000	80	450	2674	2334	34.8	15.6	171
BXRE-50E2001-C-7X	5000	80	630	3743	3266	34.8	21.9	171
BXRE-50G2001-B-7X	5000	90	450	2271	1986	34.8	15.6	145
BXRE-50G2001-C-7X	5000	90	630	3179	2780	34.8	21.9	145
BXRE-57C2001-B-7X	5700	70	450	2754	2395	34.8	15.6	176
BXRE-57C2001-C-7X	5700	70	630	3856	3353	34.8	21.9	176
BXRE-57E2001-B-7X	5700	80	450	2643	2374	34.8	15.6	169
BXRE-57E2001-C-7X	5700	80	630	3700	3322	34.8	21.9	169
BXRE-65C2001-B-7X	6500	70	450	2803	2439	34.8	15.6	179
BXRE-65C2001-C-7X	6500	70	630	3924	3414	34.8	21.9	179
BXRE-65E2001-B-7X	6500	80	450	2690	2417	34.8	15.6	172
BXRE-65E2001-C-7X	6500	80	630	3766	3383	34.8	21.9	172

Notes for Table 1:

- Nominal CCT as defined by ANSI C78.377-2011. Products with a CCT of 5000K-6500K are hot targeted to  $T_c = 85^\circ\text{C}$ .
- CRI values are typical for Decor Series Ultra, Décor Series Street and Landmark and Decor Series Class A products. CRI values are minimums for all other products. Minimum Rg value for 80 CRI products is 0, the minimum Rg values for 90 CRI products is 50, the minimum Rg values for 97 CRI products is 93. Bridgelux maintains a  $\pm 3$  tolerance on Rg values.
- Drive current is referred to as nominal drive current.
- Products tested under pulsed condition (10ms pulse width) at nominal test current where  $T_j$  (junction temperature) -  $T_c$  (case temperature) =  $25^\circ\text{C}$ .
- Typical performance values are provided as a reference only and are not a guarantee of performance.
- Bridgelux maintains a  $\pm 7\%$  tolerance on flux measurements.
- Minimum flux values at the nominal test current are guaranteed by 100% test.
- Nominal CCT is defined by the Lighting Research Center's Class A definition. The center of the Class A color bin is on the corresponding isothermal line.
- GAI value is 80. To help ensure optimal fixture level performance, GAI is measured at the fixture level, on axis, at a case temperature of  $70^\circ\text{C}$ . GAI may vary depending on fixture design and performance.

# Product Selection Guide

**Table 2:** Selection Guide, Stabilized DC Performance ( $T_c = 70^\circ\text{C}$ ) <sup>7,8</sup>

Part Number	Nominal CCT <sup>1</sup> (K)	GAI <sup>2</sup>	CRI <sup>3</sup>	Nominal Drive Current <sup>4</sup> (mA)	Typical DC Flux <sup>5,6</sup> $T_c = 70^\circ\text{C}$ (lm)	Minimum DC Flux <sup>6,9</sup> $T_c = 70^\circ\text{C}$ (lm)	Typical $V_f$ (V)	Typical Power (W)	Typical Efficacy (lm/W)
BXRE-30A2001-B-73	3000	80	93	450	1751	1576	34.4	15.5	113
BXRE-30A2001-C-73	3000	80	93	630	2452	2207	34.4	21.7	113
BXRE-35A2001-B-73	3500	80	93	450	1876	1688	34.4	15.5	121
BXRE-35A2001-C-73	3500	80	93	630	2622	2360	34.4	21.7	121

Notes for Table 2:

- Nominal CCT is defined by the Lighting Research Center's Class A definition. The center of the Class A color bin is on the corresponding isothermal line.
- To help ensure optimal fixture level performance, GAI is measured at the fixture level, on axis, at a case temperature of  $70^\circ\text{C}$ . GAI may vary depending on fixture design and performance.
- All CRI values are measured at  $T_j = T_c = 25^\circ\text{C}$ . CRI Values are specified as typical.
- Drive current is referred to as nominal drive current.
- Typical performance values are provided as a reference only and are not a guarantee of performance.
- Bridgelux maintains a  $\pm 7\%$  tolerance on flux measurements.
- Typical stabilized DC performance values are provided as reference only and are not a guarantee of performance.
- Typical performance is estimated based on operation under DC (direct current) with LED array mounted onto a heat sink with thermal interface material and the case temperature maintained at specified temperature. Based on Bridgelux test setup, values may vary depending on the thermal design of the luminaire and/or the exposed environment to which the product is subjected.
- Minimum flux values at elevated temperatures are provided for reference only and are not guaranteed by 100% production testing. Based on Bridgelux test setup, values may vary depending on the thermal design of the luminaire and/or the exposed environment to which the product is subjected.

# Product Selection Guide

**Table 3:** Selection Guide, Stabilized DC Performance ( $T_c = 85^\circ\text{C}$ )<sup>4,5</sup>

Part Number	Nominal CCT <sup>1</sup> (K)	CRI <sup>2</sup>	Nominal Drive Current <sup>3</sup> (mA)	Typical DC Flux <sup>4,5</sup> $T_c = 85^\circ\text{C}$ (lm)	Minimum DC Flux <sup>6</sup> $T_c = 85^\circ\text{C}$ (lm)	Typical $V_f$ (V)	Typical Power (W)	Typical Efficacy (lm/W)
BXRE-17E2000-C-74	1750	80	630	1745	1571	33.9	21.4	82
BXRE-20B2001-B-73	2000	65	450	2102	1892	33.9	15.3	138
BXRE-20B2001-C-73	2000	65	630	2943	2648	33.9	21.4	138
BXRE-25E2000-C-74	2500	80	630	2821	2539	33.9	21.4	132
BXRE-27E2000-B-7x	2700	80	450	2160	1944	33.9	15.3	142
BXRE-27E2000-C-7x	2700	80	630	3024	2721	33.9	21.4	142
BXRE-27G20H0-B-7x	2700	90	450	1872	1685	33.9	15.3	123
BXRE-27G20H0-C-7x	2700	90	630	2621	2358	33.9	21.4	123
BXRE-27G2000-B-7x	2700	90	450	1797	1618	33.9	15.3	118
BXRE-27G2000-C-7x	2700	90	630	2516	2265	33.9	21.4	118
BXRE-27H2000-B-7x	2700	97	450	1566	1409	33.9	15.3	103
BXRE-30C2001-B-74	3000	70	450	2477	2229	33.9	15.3	162
BXRE-30C2001-C-74	3000	70	630	3468	3121	33.9	21.4	162
BXRE-30E2000-B-7x	3000	80	450	2247	2022	33.9	15.3	147
BXRE-30E2000-C-7x	3000	80	630	3146	2831	33.9	21.4	147
BXRE-30G20H0-B-7x	3000	90	450	1956	1761	33.9	15.3	128
BXRE-30G20H0-C-7x	3000	90	630	2739	2465	33.9	21.4	128
BXRE-30G2000-B-7x	3000	90	450	1870	1683	33.9	15.3	123
BXRE-30G2000-C-7x	3000	90	630	2618	2356	33.9	21.4	123
BXRE-30G200C-B-73	3000	90	450	1740	1566	33.9	15.3	114
BXRE-30G200C-C-73	3000	90	630	2435	2192	33.9	21.4	114
BXRE-30A2001-B-73 <sup>8,9</sup>	3000	93	450	1689	1520	33.9	15.3	111
BXRE-30A2001-C-73 <sup>8,9</sup>	3000	93	630	2364	2128	33.9	21.4	111
BXRE-30H2000-B-7x	3000	97	450	1667	1500	33.9	15.3	109
BXRE-35E2000-B-7x	3500	80	450	2319	2087	33.9	15.3	152
BXRE-35E2000-C-7x	3500	80	630	3247	2922	33.9	21.4	152
BXRE-35G2000-B-7x	3500	90	450	1928	1735	33.9	15.3	126
BXRE-35G2000-C-7x	3500	90	630	2699	2429	33.9	21.4	126
BXRE-35A2001-B-73 <sup>8,9</sup>	3500	93	450	1816	1634	33.9	15.3	119
BXRE-35A2001-C-73 <sup>8,9</sup>	3500	93	630	2542	2288	33.9	21.4	119
BXRE-40C2001-B-74	4000	70	450	2519	2267	33.9	15.3	165
BXRE-40C2001-C-74	4000	70	630	3527	3174	33.9	21.4	165
BXRE-40E2000-B-7x	4000	80	450	2334	2100	33.9	15.3	153

Notes for Table 3:

- Nominal CCT as defined by ANSI C78.377-2011. Products with a CCT of 5000K-6500K are hot targeted to  $T_c = 85^\circ\text{C}$ .
- All CRI values are measured at  $T_1 = T_c = 25^\circ\text{C}$ . CRI values are typical for Decor Series Ultra, Décor Series Street and Landmark and Decor Series Class A products. CRI values are minimums for all other products. Minimum Rg value for 80 CRI products is 0, the minimum Rg values for 90 CRI products is 50, the minimum Rg values for 97 CRI products is 93. Bridgelux maintains a  $\pm 3$  tolerance on Rg values.
- Drive current is referred to as nominal drive current.
- Typical stabilized DC performance values are provided as reference only and are not a guarantee of performance.
- Typical performance is estimated based on operation under DC (direct current) with LED array mounted onto a heat sink with thermal interface material and the case temperature maintained at  $85^\circ\text{C}$ . Based on Bridgelux test setup, values may vary depending on the thermal design of the luminaire and/or the exposed environment to which the product is subjected.
- Minimum flux values at elevated temperatures are provided for reference only and are not guaranteed by 100% production testing. Based on Bridgelux test setup, values may vary depending on the thermal design of the luminaire and/or the exposed environment to which the product is subjected.
- Nominal CCT is defined by the Lighting Research Center's Class A definition. The center of the Class A color bin is on the corresponding isothermal line.
- GAI value is 80. To help ensure optimal fixture level performance, GAI is measured at the fixture level, on axis, at a case temperature of  $70^\circ\text{C}$ . GAI may vary depending on fixture design and performance.



# Product Selection Guide

**Table 3:** Selection Guide, Stabilized DC Performance ( $T_c = 85^\circ\text{C}$ )<sup>4,5</sup> (continued)

Part Number	Nominal CCT <sup>1</sup> (K)	CRI <sup>2</sup>	Nominal Drive Current <sup>3</sup> (mA)	Typical DC Flux <sup>4,5</sup> $T_c = 85^\circ\text{C}$ (lm)	Minimum DC Flux <sup>6</sup> $T_c = 85^\circ\text{C}$ (lm)	Typical $V_f$ (V)	Typical Power (W)	Typical Efficacy (lm/W)
BXRE-40E2000-C-7x	4000	80	630	3267	2941	33.9	21.4	153
BXRE-40G2000-B-7x	4000	90	450	2000	1800	33.9	15.3	131
BXRE-40G2000-C-7x	4000	90	630	2801	2521	33.9	21.4	131
BXRE-50C2001-B-7x	5000	70	450	2566	2309	33.9	15.3	168
BXRE-50C2001-C-7x	5000	70	630	3592	3233	33.9	21.4	168
BXRE-50E2001-B-7x	5000	80	450	2406	2166	33.9	15.3	158
BXRE-50E2001-C-7x	5000	80	630	3369	3032	33.9	21.4	158
BXRE-50G2001-B-7x	5000	90	450	2044	1840	33.9	15.3	134
BXRE-50G2001-C-7x	5000	90	630	2862	2575	33.9	21.4	134
BXRE-57C2001-B-7x	5700	70	450	2479	2231	33.9	15.3	162
BXRE-57C2001-C-7x	5700	70	630	3470	3123	33.9	21.4	162
BXRE-57E2001-B-7x	5700	80	450	2378	2141	33.9	15.3	156
BXRE-57E2001-C-7x	5700	80	630	3330	2997	33.9	21.4	156
BXRE-65C2001-B-7x	6500	70	450	2522	2270	33.9	15.3	165
BXRE-65C2001-C-7x	6500	70	630	3531	3178	33.9	21.4	165
BXRE-65E2001-B-7x	6500	80	450	2421	2179	33.9	15.3	159
BXRE-65E2001-C-7x	6500	80	630	3389	3050	33.9	21.4	159

Notes for Table 3:

- Nominal CCT as defined by ANSI C78.377-2011. Products with a CCT of 5000K-6500K are hot targeted to  $T_c = 85^\circ\text{C}$ .
- All CRI values are measured at  $T_c = T_a = 25^\circ\text{C}$ . CRI values are typical for Decor Series Ultra, Décor Series Street and Landmark and Decor Series Class A products. CRI values are minimums for all other products. Minimum Rg value for 80 CRI products is 0, the minimum Rg values for 90 CRI products is 50, the minimum Rg values for 97 CRI products is 93. Bridgelux maintains a  $\pm 3$  tolerance on Rg values.
- Drive current is referred to as nominal drive current.
- Typical stabilized DC performance values are provided as reference only and are not a guarantee of performance.
- Typical performance is estimated based on operation under DC (direct current) with LED array mounted onto a heat sink with thermal interface material and the case temperature maintained at  $85^\circ\text{C}$ . Based on Bridgelux test setup, values may vary depending on the thermal design of the luminaire and/or the exposed environment to which the product is subjected.
- Minimum flux values at elevated temperatures are provided for reference only and are not guaranteed by 100% production testing. Based on Bridgelux test setup, values may vary depending on the thermal design of the luminaire and/or the exposed environment to which the product is subjected.
- Nominal CCT is defined by the Lighting Research Center's Class A definition. The center of the Class A color bin is on the corresponding isothermal line.
- GAI value is 80. To help ensure optimal fixture level performance, GAI is measured at the fixture level, on axis, at a case temperature of  $70^\circ\text{C}$ . GAI may vary depending on fixture design and performance.

# Performance at Commonly Used Drive Currents

V Series LED arrays are tested to the specifications shown using the nominal drive currents in Table 1. V Series may also be driven at other drive currents dependent on specific application design requirements. The performance at any drive current can be derived from the current vs. voltage characteristics shown in Figures 1 & 2 and the flux vs. current characteristics shown in Figures 3 & 4. The performance at commonly used drive currents is summarized in Table 4.

**Table 4:** Product Performance at Commonly Used Drive Currents

Part Number	CRI	Drive Current <sup>1</sup> (mA)	Typical $V_f$ $T_c = 25^\circ\text{C}$ (V)	Typical Power $T_c = 25^\circ\text{C}$ (W)	Typical Flux <sup>2</sup> $T_c = 25^\circ\text{C}$ (lm)	Typical DC Flux <sup>3</sup> $T_c = 85^\circ\text{C}$ (lm)	Typical Efficacy $T_c = 25^\circ\text{C}$ (lm/W)
BXRE-17E2000-C-74	80	158	32.3	5.1	527	499	104
		315	33.2	10.4	1018	959	97
		<b>630</b>	<b>34.8</b>	<b>21.9</b>	<b>1939</b>	<b>1745</b>	<b>89</b>
		945	36.1	34.1	2787	2606	82
		1260	37.3	47.0	3556	3314	76
BXRE-20B2001-B-7x	65	113	32.3	3.6	640	591	176
		225	33.2	7.5	1235	1133	165
		<b>450</b>	<b>34.8</b>	<b>15.6</b>	<b>2335</b>	<b>1992</b>	<b>149</b>
		675	36.0	24.3	3379	3067	139
		900	37.2	33.5	4309	3892	129
BXRE-20B2001-C-73	65	158	32.3	5.1	889	842	175
		315	33.2	10.4	1716	1617	164
		<b>630</b>	<b>34.8</b>	<b>21.9</b>	<b>3270</b>	<b>2853</b>	<b>149</b>
		945	36.1	34.1	4698	4394	138
		1260	37.3	47.0	5995	5588	128
BXRE-25E2000-C-74	80	158	32.3	5.1	852	807	167
		315	33.2	10.4	1645	1550	157
		<b>630</b>	<b>34.8</b>	<b>21.9</b>	<b>3134</b>	<b>2821</b>	<b>143</b>
		945	36.1	34.1	4504	4212	132
		1260	37.3	47.0	5747	5357	122
BXRE-27E2000-B-7x	80	113	32.3	3.6	658	607	181
		225	33.2	7.5	1269	1165	170
		<b>450</b>	<b>34.8</b>	<b>15.6</b>	<b>2400</b>	<b>2160</b>	<b>153</b>
		675	36.0	24.3	3472	3152	143
		900	37.2	33.5	4428	3999	132
BXRE-27E2000-C-7x	80	158	32.3	5.1	914	865	179
		315	33.2	10.4	1763	1662	169
		<b>630</b>	<b>34.8</b>	<b>21.9</b>	<b>3360</b>	<b>3024</b>	<b>153</b>
		945	36.1	34.1	4828	4515	142
		1260	37.3	47.0	6161	5742	131
BXRE-27G20H0-B-7x	90	113	32.3	3.6	570	526	157
		225	33.2	7.5	1100	1009	147
		<b>450</b>	<b>34.8</b>	<b>15.6</b>	<b>2080</b>	<b>1872</b>	<b>133</b>
		675	36.0	24.3	3009	2731	124
		900	37.2	33.5	3837	3466	115
BXRE-27G20H0-C-7x	90	158	32.3	5.1	792	750	156
		315	33.2	10.4	1528	1440	146
		<b>630</b>	<b>34.8</b>	<b>21.9</b>	<b>2912</b>	<b>2621</b>	<b>133</b>
		945	36.1	34.1	4184	3913	123
		1260	37.3	47.0	5339	4976	114

Notes for Table 4:

1. Alternate drive currents are provided for reference only and are not a guarantee of performance.
2. Bridgelux maintains a  $\pm 7\%$  tolerance on flux measurements.
3. Typical stabilized DC performance values are provided as reference only and are not a guarantee of performance.

# Performance at Commonly Used Drive Currents

**Table 4:** Product Performance at Commonly Used Drive Currents (Continued)

Part Number	CRI	Drive Current <sup>1</sup> (mA)	Typical V <sub>f</sub> T <sub>c</sub> = 25°C (V)	Typical Power T <sub>c</sub> = 25°C (W)	Typical Flux <sup>2</sup> T <sub>c</sub> = 25°C (lm)	Typical DC Flux <sup>3</sup> T <sub>c</sub> = 85°C (lm)	Typical Efficacy T <sub>c</sub> = 25°C (lm/W)
BXRE-27G2000-B-7x	90	113	32.3	3.6	547	505	151
		225	33.2	7.5	1056	969	142
		<b>450</b>	<b>34.8</b>	<b>15.6</b>	<b>1997</b>	<b>1797</b>	<b>128</b>
		675	36.0	24.3	2890	2623	119
		900	37.2	33.5	3685	3328	110
BXRE-27G2000-C-7x	90	158	32.3	5.1	760	720	149
		315	33.2	10.4	1467	1383	140
		<b>630</b>	<b>34.8</b>	<b>21.9</b>	<b>2796</b>	<b>2516</b>	<b>128</b>
		945	36.1	34.1	4018	3758	118
		1260	37.3	47.0	5127	4778	109
BXRE-27H2000-B-7x	97	113	32.3	3.6	477	440	131
		225	33.2	7.5	920	844	123
		<b>450</b>	<b>34.8</b>	<b>15.6</b>	<b>1740</b>	<b>1566</b>	<b>111</b>
		675	36.0	24.3	2517	2284	103
		900	37.2	33.5	3210	2899	96
BXRE-30C2001-B-74	70	113	32.3	3.6	748	709	206
		225	33.2	7.5	1444	1361	194
		<b>450</b>	<b>34.8</b>	<b>15.6</b>	<b>2752</b>	<b>2477</b>	<b>176</b>
		675	36.0	24.3	3955	3699	163
		900	37.2	33.5	5046	4703	151
BXRE-30C2001-C-74	70	158	32.3	5.1	1056	975	207
		315	33.2	10.4	2038	1870	195
		<b>630</b>	<b>34.8</b>	<b>21.9</b>	<b>3853</b>	<b>3468</b>	<b>176</b>
		945	36.1	34.1	5575	5060	163
		1260	37.3	47.0	7109	6421	151
BXRE-30E2000-B-7x	80	113	32.3	3.6	684	631	188
		225	33.2	7.5	1320	1211	177
		<b>450</b>	<b>34.8</b>	<b>15.6</b>	<b>2497</b>	<b>2247</b>	<b>160</b>
		675	36.0	24.3	3612	3279	148
		900	37.2	33.5	4606	4160	138
BXRE-30E2000-C-7x	80	158	32.3	5.1	950	900	187
		315	33.2	10.4	1834	1729	176
		<b>630</b>	<b>34.8</b>	<b>21.9</b>	<b>3495</b>	<b>3146</b>	<b>160</b>
		945	36.1	34.1	5022	4697	147
		1260	37.3	47.0	6409	5973	136
BXRE-30G20H0-B-7x	90	113	32.3	3.6	596	550	164
		225	33.2	7.5	1150	1055	154
		<b>450</b>	<b>34.8</b>	<b>15.6</b>	<b>2174</b>	<b>1956</b>	<b>139</b>
		675	36.0	24.3	3145	2854	129
		900	37.2	33.5	4011	3622	120
BXRE-30G20H0-C-7x	90	158	32.3	5.1	827	784	163
		315	33.2	10.4	1597	1505	153
		<b>630</b>	<b>34.8</b>	<b>21.9</b>	<b>3043</b>	<b>2739</b>	<b>139</b>
		945	36.1	34.1	4373	4090	128
		1260	37.3	47.0	5580	5201	119

Notes for Table 4:

1. Alternate drive currents are provided for reference only and are not a guarantee of performance.
2. Bridgelux maintains a ± 7% tolerance on flux measurements.
3. Typical stabilized DC performance values are provided as reference only and are not a guarantee of performance.

# Performance at Commonly Used Drive Currents

**Table 4:** Product Performance at Commonly Used Drive Currents (Continued)

Part Number	CRI	Drive Current <sup>1</sup> (mA)	Typical V <sub>f</sub> T <sub>c</sub> = 25°C (V)	Typical Power T <sub>c</sub> = 25°C (W)	Typical Flux <sup>2</sup> T <sub>c</sub> = 25°C (lm)	Typical DC Flux <sup>3</sup> T <sub>c</sub> = 85°C (lm)	Typical Efficacy T <sub>c</sub> = 25°C (lm/W)
BXRE-30G2000-B-7x	90	113	32.3	3.6	569	526	157
		225	33.2	7.5	1099	1008	147
		<b>450</b>	<b>34.8</b>	<b>15.6</b>	<b>2078</b>	<b>1870</b>	<b>133</b>
		675	36.0	24.3	3006	2729	124
		900	37.2	33.5	3834	3463	115
BXRE-30G2000-C-7x	90	158	32.3	5.1	791	749	155
		315	33.2	10.4	1526	1439	146
		<b>630</b>	<b>34.8</b>	<b>21.9</b>	<b>2909</b>	<b>2618</b>	<b>133</b>
		945	36.1	34.1	4180	3909	123
		1260	37.3	47.0	5334	4971	113
BXRE-30G200C-B-73	90	113	32.3	3.6	530	489	146
		225	33.2	7.5	1022	938	137
		<b>450</b>	<b>34.8</b>	<b>15.6</b>	<b>1933</b>	<b>1740</b>	<b>124</b>
		675	36.0	24.3	2796	2538	115
		900	37.2	33.5	3566	3221	107
BXRE-30G200C-C-73	90	158	32.3	5.1	742	684	146
		315	33.2	10.4	1431	1313	137
		<b>630</b>	<b>34.8</b>	<b>21.9</b>	<b>2706</b>	<b>2435</b>	<b>124</b>
		945	36.1	34.1	3915	3554	115
		1260	37.3	47.0	4993	4509	106
BXRE-30A2001-B-73	93	113	32.3	3.6	514	475	141
		225	33.2	7.5	992	911	133
		<b>450</b>	<b>34.8</b>	<b>15.6</b>	<b>1877</b>	<b>1689</b>	<b>120</b>
		675	36.0	24.3	2715	2464	112
		900	37.2	33.5	3462	3127	103
BXRE-30A2001-C-73	93	158	32.3	5.1	720	664	141
		315	33.2	10.4	1389	1275	133
		<b>630</b>	<b>34.8</b>	<b>21.9</b>	<b>2627</b>	<b>2364</b>	<b>120</b>
		945	36.1	34.1	3801	3450	111
		1260	37.3	47.0	4847	4378	103
BXRE-30H2000-B-7x	97	113	32.3	3.6	508	469	140
		225	33.2	7.5	980	899	131
		<b>450</b>	<b>34.8</b>	<b>15.6</b>	<b>1852</b>	<b>1667</b>	<b>118</b>
		675	36.0	24.3	2680	2432	110
		900	37.2	33.5	3418	3087	102
BXRE-35E2000-B-7x	80	113	32.3	3.6	706	652	194
		225	33.2	7.5	1363	1251	183
		<b>450</b>	<b>34.8</b>	<b>15.6</b>	<b>2577</b>	<b>2319</b>	<b>165</b>
		675	36.0	24.3	3729	3384	153
		900	37.2	33.5	4755	4295	142
BXRE-35E2000-C-7x	80	158	32.3	5.1	981	929	193
		315	33.2	10.4	1893	1785	181
		<b>630</b>	<b>34.8</b>	<b>21.9</b>	<b>3608</b>	<b>3247</b>	<b>165</b>
		945	36.1	34.1	5185	4849	152
		1260	37.3	47.0	6615	6166	141

Notes for Table 4:

1. Alternate drive currents are provided for reference only and are not a guarantee of performance.
2. Bridgelux maintains a ± 7% tolerance on flux measurements.
3. Typical stabilized DC performance values are provided as reference only and are not a guarantee of performance.

# Performance at Commonly Used Drive Currents

**Table 4:** Product Performance at Commonly Used Drive Currents (Continued)

Part Number	CRI	Drive Current <sup>1</sup> (mA)	Typical V <sub>f</sub> T <sub>c</sub> = 25°C (V)	Typical Power T <sub>c</sub> = 25°C (W)	Typical Flux <sup>2</sup> T <sub>c</sub> = 25°C (lm)	Typical DC Flux <sup>3</sup> T <sub>c</sub> = 85°C (lm)	Typical Efficacy T <sub>c</sub> = 25°C (lm/W)
BXRE-35G2000-B-7x	90	113	32.3	3.6	587	542	161
		225	33.2	7.5	1133	1039	152
		<b>450</b>	<b>34.8</b>	<b>15.6</b>	<b>2142</b>	<b>1928</b>	<b>137</b>
		675	36.0	24.3	3099	2813	127
		900	37.2	33.5	3953	3570	118
BXRE-35G2000-C-7x	90	158	32.3	5.1	815	772	160
		315	33.2	10.4	1574	1483	151
		<b>630</b>	<b>34.8</b>	<b>21.9</b>	<b>2999</b>	<b>2699</b>	<b>137</b>
		945	36.1	34.1	4310	4030	126
		1260	37.3	47.0	5499	5125	117
BXRE-35A2001-B-73	93	113	32.3	3.6	553	510	152
		225	33.2	7.5	1067	979	143
		<b>450</b>	<b>34.8</b>	<b>15.6</b>	<b>2017</b>	<b>1816</b>	<b>129</b>
		675	36.0	24.3	2919	2649	120
		900	37.2	33.5	3722	3362	111
BXRE-35A2001-C-73	93	158	32.3	5.1	768	727	151
		315	33.2	10.4	1482	1397	142
		<b>630</b>	<b>34.8</b>	<b>21.9</b>	<b>2824</b>	<b>2542</b>	<b>129</b>
		945	36.1	34.1	4058	3795	119
		1260	37.3	47.0	5178	4826	110
BXRE-40C2001-B-74	70	113	32.3	3.6	767	708	211
		225	33.2	7.5	1480	1358	198
		<b>450</b>	<b>34.8</b>	<b>15.6</b>	<b>2799</b>	<b>2519</b>	<b>179</b>
		675	36.0	24.3	4050	3676	166
		900	37.2	33.5	5165	4665	154
BXRE-40C2001-C-74	70	158	32.3	5.1	1065	1009	209
		315	33.2	10.4	2056	1938	197
		<b>630</b>	<b>34.8</b>	<b>21.9</b>	<b>3919</b>	<b>3527</b>	<b>179</b>
		945	36.1	34.1	5631	5266	165
		1260	37.3	47.0	7185	6697	153
BXRE-40E2000-B-7x	80	113	32.3	3.6	711	656	195
		225	33.2	7.5	1371	1258	184
		<b>450</b>	<b>34.8</b>	<b>15.6</b>	<b>2593</b>	<b>2334</b>	<b>166</b>
		675	36.0	24.3	3752	3405	154
		900	37.2	33.5	4785	4322	143
BXRE-40E2000-C-7x	80	158	32.3	5.1	987	935	194
		315	33.2	10.4	1905	1796	182
		<b>630</b>	<b>34.8</b>	<b>21.9</b>	<b>3630</b>	<b>3267</b>	<b>166</b>
		945	36.1	34.1	5217	4879	153
		1260	37.3	47.0	6657	6204	142
BXRE-40G2000-B-7x	90	113	32.3	3.6	609	562	168
		225	33.2	7.5	1175	1079	158
		<b>450</b>	<b>34.8</b>	<b>15.6</b>	<b>2223</b>	<b>2000</b>	<b>142</b>
		675	36.0	24.3	3216	2919	132
		900	37.2	33.5	4101	3704	123

Notes for Table 4:

1. Alternate drive currents are provided for reference only and are not a guarantee of performance.
2. Bridgelux maintains a ± 7% tolerance on flux measurements.
3. Typical stabilized DC performance values are provided as reference only and are not a guarantee of performance.

# Performance at Commonly Used Drive Currents

**Table 4:** Product Performance at Commonly Used Drive Currents (Continued)

Part Number	CRI	Drive Current <sup>1</sup> (mA)	Typical V <sub>f</sub> T <sub>c</sub> = 25°C (V)	Typical Power T <sub>c</sub> = 25°C (W)	Typical Flux <sup>2</sup> T <sub>c</sub> = 25°C (lm)	Typical DC Flux <sup>3</sup> T <sub>c</sub> = 85°C (lm)	Typical Efficacy T <sub>c</sub> = 25°C (lm/W)
BXRE-40G2000-C-7x	90	158	32.3	5.1	846	801	166
		315	33.2	10.4	1633	1539	156
		<b>630</b>	<b>34.8</b>	<b>21.9</b>	<b>3112</b>	<b>2801</b>	<b>142</b>
		945	36.1	34.1	4472	4182	131
		1260	37.3	47.0	5706	5318	121
BXRE-50C2001-B-7x	70	113	32.3	3.6	781	721	215
		225	33.2	7.5	1508	1383	202
		<b>450</b>	<b>34.8</b>	<b>15.6</b>	<b>2851</b>	<b>2566</b>	<b>182</b>
		675	36.0	24.3	4125	3744	170
		900	37.2	33.5	5260	4751	157
BXRE-50C2001-C-7x	70	158	32.3	5.1	1085	1028	213
		315	33.2	10.4	2094	1974	200
		<b>630</b>	<b>34.8</b>	<b>21.9</b>	<b>3991</b>	<b>3592</b>	<b>182</b>
		945	36.1	34.1	5735	5364	168
		1260	37.3	47.0	7318	6821	156
BXRE-50E2001-B-7x	80	113	32.3	3.6	733	676	201
		225	33.2	7.5	1414	1297	189
		<b>450</b>	<b>34.8</b>	<b>15.6</b>	<b>2674</b>	<b>2406</b>	<b>171</b>
		675	36.0	24.3	3868	3511	159
		900	37.2	33.5	4933	4456	147
BXRE-50E2001-C-7x	80	158	32.3	5.1	1018	964	200
		315	33.2	10.4	1964	1852	188
		<b>630</b>	<b>34.8</b>	<b>21.9</b>	<b>3743</b>	<b>3369</b>	<b>171</b>
		945	36.1	34.1	5379	5030	158
		1260	37.3	47.0	6863	6397	146
BXRE-50G2001-B-7x	90	113	32.3	3.6	622	574	171
		225	33.2	7.5	1201	1102	161
		<b>450</b>	<b>34.8</b>	<b>15.6</b>	<b>2271</b>	<b>2044</b>	<b>145</b>
		675	36.0	24.3	3286	2982	135
		900	37.2	33.5	4190	3785	125
BXRE-50G2001-C-7x	90	158	32.3	5.1	864	819	170
		315	33.2	10.4	1668	1573	160
		<b>630</b>	<b>34.8</b>	<b>21.9</b>	<b>3179</b>	<b>2862</b>	<b>145</b>
		945	36.1	34.1	4569	4273	134
		1260	37.3	47.0	5830	5434	124
BXRE-57C2001-B-7x	70	113	32.3	3.6	755	697	208
		225	33.2	7.5	1457	1336	195
		<b>450</b>	<b>34.8</b>	<b>15.6</b>	<b>2754</b>	<b>2479</b>	<b>176</b>
		675	36.0	24.3	3985	3617	164
		900	37.2	33.5	5082	4590	152
BXRE-57C2001-C-7x	70	158	32.3	5.1	1048	993	206
		315	33.2	10.4	2023	1907	194
		<b>630</b>	<b>34.8</b>	<b>21.9</b>	<b>3856</b>	<b>3470</b>	<b>176</b>
		945	36.1	34.1	5541	5182	162
		1260	37.3	47.0	7070	6590	150

Notes for Table 4:

1. Alternate drive currents are provided for reference only and are not a guarantee of performance.
2. Bridgelux maintains a ± 7% tolerance on flux measurements.
3. Typical stabilized DC performance values are provided as reference only and are not a guarantee of performance.

# Performance at Commonly Used Drive Currents

**Table 4:** Product Performance at Commonly Used Drive Currents (Continued)

Part Number	CRI	Drive Current <sup>1</sup> (mA)	Typical V <sub>f</sub> T <sub>c</sub> = 25°C (V)	Typical Power T <sub>c</sub> = 25°C (W)	Typical Flux <sup>2</sup> T <sub>c</sub> = 25°C (lm)	Typical DC Flux <sup>3</sup> T <sub>c</sub> = 85°C (lm)	Typical Efficacy T <sub>c</sub> = 25°C (lm/W)
BXRE-57E2001-B-7x	80	113	32.3	3.6	724	668	199
		225	33.2	7.5	1398	1282	187
		<b>450</b>	<b>34.8</b>	<b>15.6</b>	<b>2643</b>	<b>2378</b>	<b>169</b>
		675	36.0	24.3	3824	3471	157
		900	37.2	33.5	4876	4404	146
BXRE-57E2001-C-7x	80	158	32.3	5.1	1006	953	198
		315	33.2	10.4	1942	1830	186
		<b>630</b>	<b>34.8</b>	<b>21.9</b>	<b>3700</b>	<b>3330</b>	<b>169</b>
		945	36.1	34.1	5317	4972	156
		1260	37.3	47.0	6784	6323	144
BXRE-65C2001-B-7x	70	113	32.3	3.6	768	709	211
		225	33.2	7.5	1482	1360	199
		<b>450</b>	<b>34.8</b>	<b>15.6</b>	<b>2803</b>	<b>2522</b>	<b>179</b>
		675	36.0	24.3	4055	3680	167
		900	37.2	33.5	5171	4670	155
BXRE-65C2001-C-7x	70	158	32.3	5.1	1067	1010	210
		315	33.2	10.4	2059	1941	197
		<b>630</b>	<b>34.8</b>	<b>21.9</b>	<b>3924</b>	<b>3531</b>	<b>179</b>
		945	36.1	34.1	5638	5273	165
		1260	37.3	47.0	7194	6705	153
BXRE-65E2001-B-7x	80	113	32.3	3.6	737	680	203
		225	33.2	7.5	1422	1305	191
		<b>450</b>	<b>34.8</b>	<b>15.6</b>	<b>2690</b>	<b>2421</b>	<b>172</b>
		675	36.0	24.3	3892	3532	160
		900	37.2	33.5	4963	4482	148
BXRE-65E2001-C-7x	80	158	32.3	5.1	1024	970	201
		315	33.2	10.4	1976	1863	189
		<b>630</b>	<b>34.8</b>	<b>21.9</b>	<b>3766</b>	<b>3389</b>	<b>172</b>
		945	36.1	34.1	5411	5060	159
		1260	37.3	47.0	6904	6435	147

Notes for Table 4:

1. Alternate drive currents are provided for reference only and are not a guarantee of performance.
2. Bridgelux maintains a ± 7% tolerance on flux measurements.
3. Typical stabilized DC performance values are provided as reference only and are not a guarantee of performance.

# Electrical Characteristics

**Table 5:** Electrical Characteristics

Part Number	Drive Current (mA)	Forward Voltage Pulsed, $T_c = 25^\circ\text{C}$ (V) <sup>1, 2, 3, 8</sup>			Typical Coefficient of Forward Voltage <sup>4</sup> $\Delta V_f / \Delta T_c$ (mV/ $^\circ\text{C}$ )	Typical Thermal Resistance Junction to Case <sup>5,6</sup> $R_{j-c}$ ( $^\circ\text{C}/\text{W}$ )	Driver Selection Voltages <sup>7</sup> (V)	
		Minimum	Typical	Maximum			$V_f$ Min. Hot $T_c = 105^\circ\text{C}$ (V)	$V_f$ Max. Cold $T_c = -40^\circ\text{C}$ (V)
BXRE-xxx200x-B-7x	450	32.1	34.8	37.4	-14.1	0.28	31.0	38.3
	900	34.4	37.2	40.0	-14.1	0.34	33.3	40.9
BXRE-xxx200x-C-7x	630	32.1	34.8	37.4	-14.1	0.20	31.0	38.3
	1260	34.5	37.3	40.1	-14.1	0.24	33.4	41.0

Notes for Table 5:

- Parts are tested in pulsed conditions,  $T_c = 25^\circ\text{C}$ . Pulse width is 10ms.
- Voltage minimum and maximum are provided for reference only and are not a guarantee of performance.
- Bridgelux maintains a tester tolerance of  $\pm 0.10\text{V}$  on forward voltage measurements.
- Typical coefficient of forward voltage tolerance is  $\pm 0.1\text{mV}$  for nominal current.
- Thermal resistance values are based from test data of a 3000K 80 CRI product.
- Thermal resistance value was calculated using total electrical input power; optical power was not subtracted from input power. The thermal interface material used during testing is not included in the thermal resistance value.
- $V_f$  min hot and max cold values are provided as reference only and are not guaranteed by test. These values are provided to aid in driver design and selection over the operating range of the product.
- This product has been designed and manufactured per IEC 62031:2014. This product has passed dielectric withstand voltage testing at 1160 V. The working voltage designated for the insulation is 80V d.c. The maximum allowable voltage across the array must be determined in the end product application.



# Eye Safety

**Table 6:** Eye Safety Risk Group (RG) Classifications

Part Number	Drive Current <sup>5</sup> (mA)	CCT <sup>5</sup>			
		2700K/3000K	4000K <sup>2</sup>	5000K <sup>3</sup>	6500K <sup>4</sup>
BXRE-xxx200x-B-7x	450	RG1	RG1	RG1	RG1
	675	RG1	RG1	RG1	RG2
	900	RG1	RG1	RG2	RG2
BXRE-xxx200x-C-7x	630	RG1	RG1	RG1	RG1
	945	RG1	RG1	RG2	RG2
	1260	RG1	RG2	RG2	RG2

Notes for Table 6:

1. Eye safety classification for the use of Bridgelux V Series LED arrays is in accordance with specification IEC/TR 62778: Application of IEC 62471 for the assessment of blue light hazard to light sources and luminaires.
2. For products classified as RG2 at 4000K,  $E_{thr} = 1847.5$  lx.
3. For products classified as RG2 at 5000K  $E_{thr} = 1315.8$  lx.
4. For products classified as RG2 at 6500K,  $E_{thr} = 1124.5$  lx.
5. Please contact your Bridgelux sales representative for  $E_{thr}$  values at specific drive currents and CCTs not listed.

# Absolute Maximum Ratings

**Table 7:** Maximum Ratings

Parameter	Maximum Rating	
LED Junction Temperature ( $T_j$ )	150°C	
Storage Temperature	-40°C to +105°C	
Operating Case Temperature <sup>1</sup> ( $T_c$ )	105°C	
Soldering Temperature <sup>2</sup>	300°C or lower for a maximum of 6 seconds	
	BXRE-xxx200x-B-7x	BXRE-xxx200x-C-7x
Maximum Drive Current <sup>3</sup>	900mA	1260mA
Maximum Peak Pulsed Drive Current <sup>4</sup>	1290mA	1800mA
Maximum Reverse Voltage <sup>5</sup>	-60V	-60V

Notes for Table 7:

1. For IEC 62717 requirement, please consult your Bridgelux sales representative.
2. Refer to Bridgelux Application Note AN101: Handling and Assembly of Bridgelux V Series LED Arrays
3. Arrays may be driven at higher currents however lumen maintenance may be reduced.
4. Bridgelux recommends a maximum duty cycle of 10% and pulse width of 20 ms when operating LED Arrays at maximum peak pulsed current specified. Maximum peak pulsed currents indicate values where LED Arrays can be driven without catastrophic failures.
5. Light emitting diodes are not designed to be driven in reverse voltage and will not produce light under this condition. Maximum rating provided for reference only.

# Performance Curves

**Figure 1: V13B Drive Current vs. Voltage**

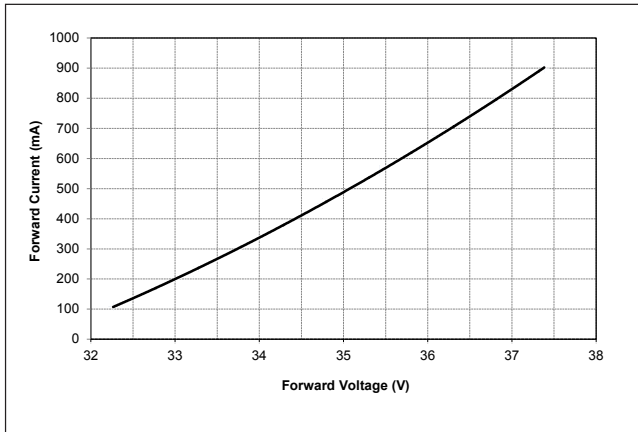

**Figure 2: V13C Drive Current vs. Voltage**

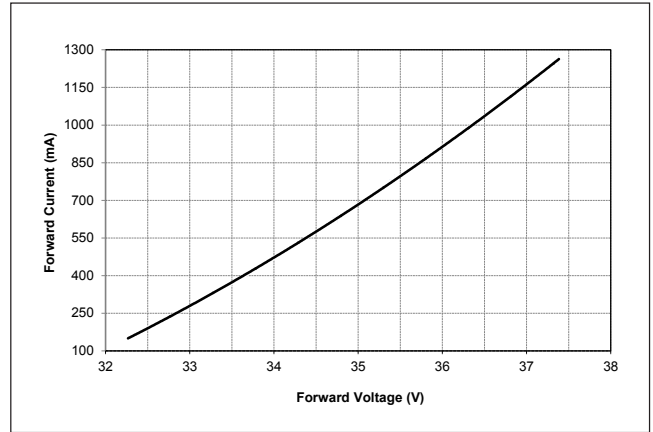

**Figure 3: V13B Drive Current vs. Voltage**

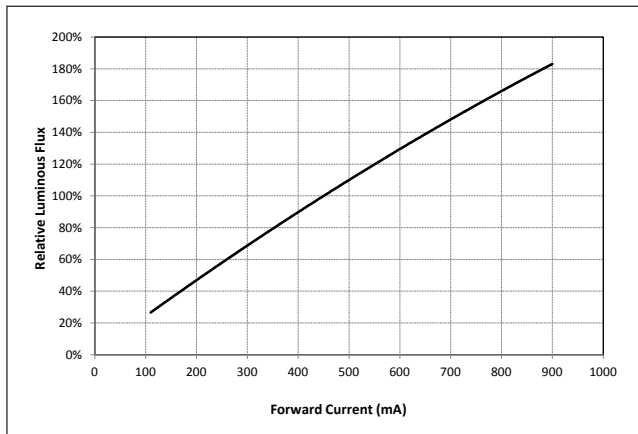

**Figure 4: V13C Typical Relative Flux vs. Current**

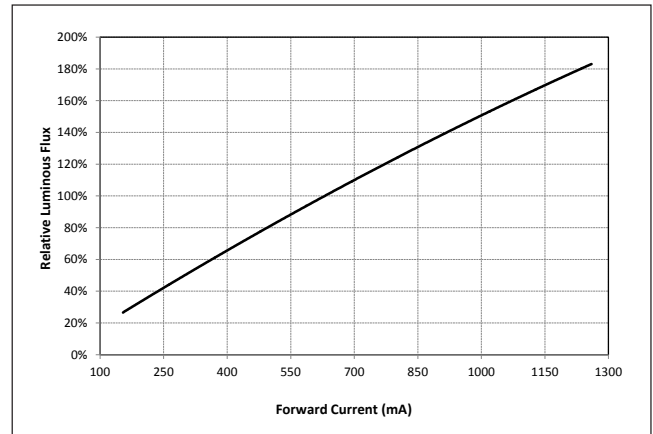

Notes for Figures 1-4:

1. Bridgelux does not recommend driving high power LEDs at low currents. Doing so may produce unpredictable results. Pulse width modulation (PWM) is recommended for dimming effects.
2. Products tested under pulsed condition (10ms pulse width) at nominal test current where  $T_j$  (junction temperature) =  $T_c$  (case temperature) = 25°C.

# Performance Curves

**Figure 5: Typical DC Flux vs. Case Temperature**

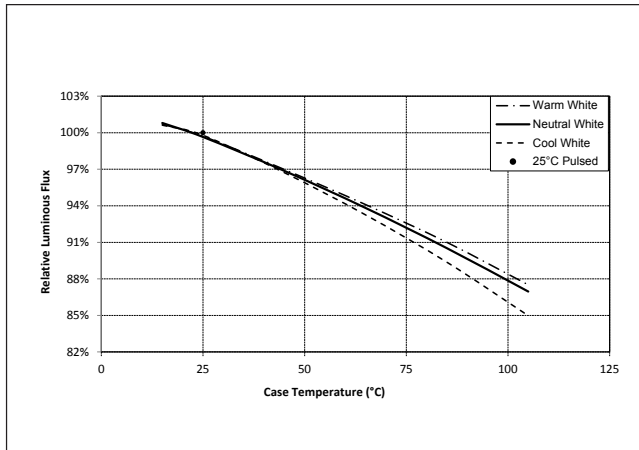

**Figure 6: Typical DC ccy Shift vs. Case Temperature**

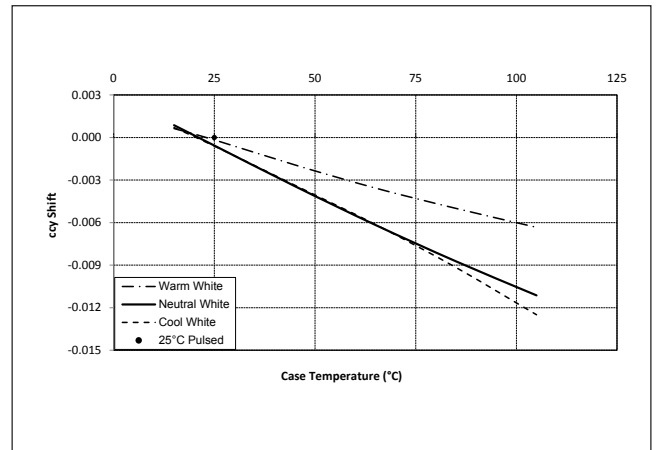

**Figure 7: Typical DC ccx Shift vs. Case Temperature**

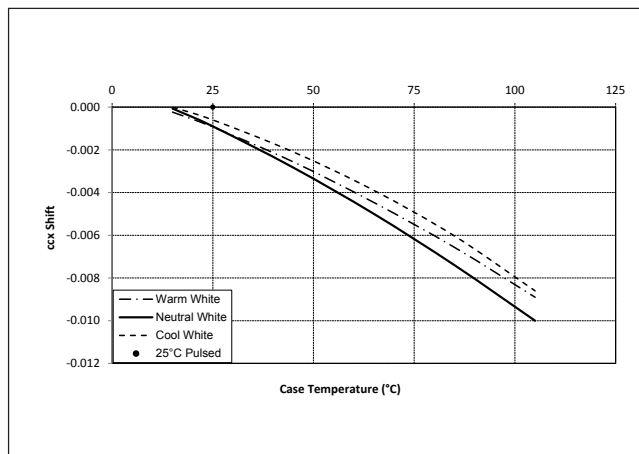

Notes for Figures 5-7:

1. Characteristics shown for warm white based on 3000K and 80 CRI.
2. Characteristics shown for neutral white based on 4000K and 80 CRI.
3. Characteristics shown for cool white based on 5000K and 70 CRI.
4. Characteristics shown for warm white includes Decor Series Class A
5. For other color SKUs, the shift in color will vary. Please contact your Bridgelux Sales Representative for more information.

# Performance Curves

**Figure 8: 2000K, 65 CRI Color Shift vs. Case Temperature**

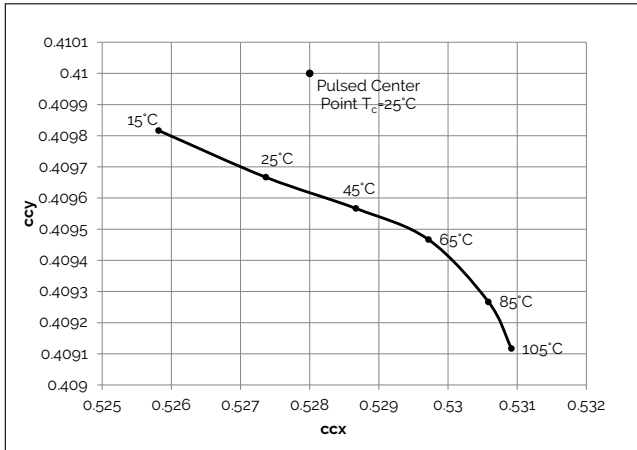

**Figure 9: 3000K, 90 CRI Color Shift vs. Case Temperature<sup>1,3</sup>**

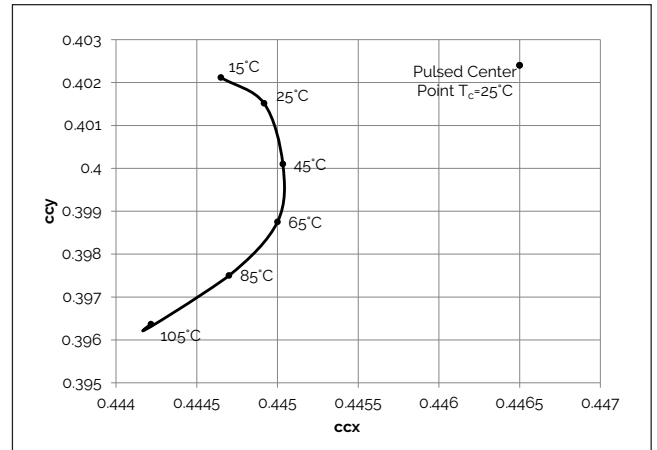

**Figure 10: 2700K, 97 CRI Color Shift vs. Case Temperature<sup>1</sup>**

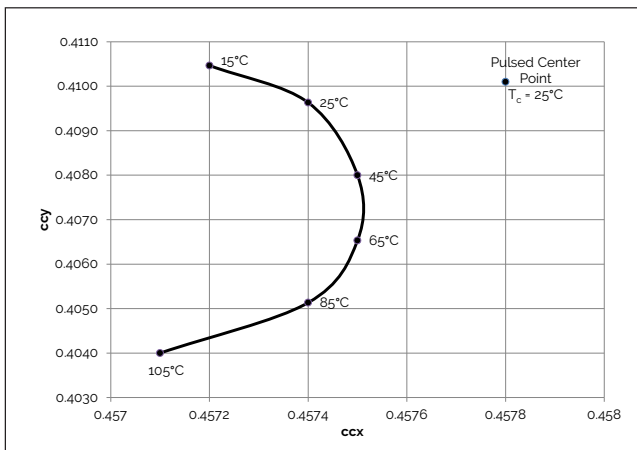

**Figure 11: 3000K, 97 CRI Color Shift vs. Case Temperature<sup>1</sup>**

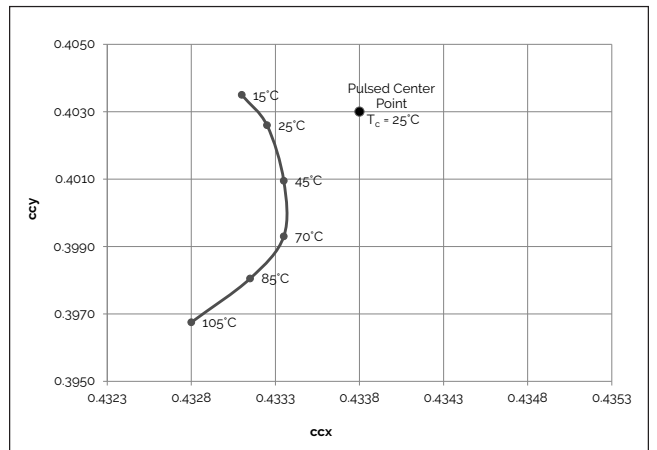

**Figure 12: 3000K Class A Color Shift vs. Case Temperature<sup>1</sup>**

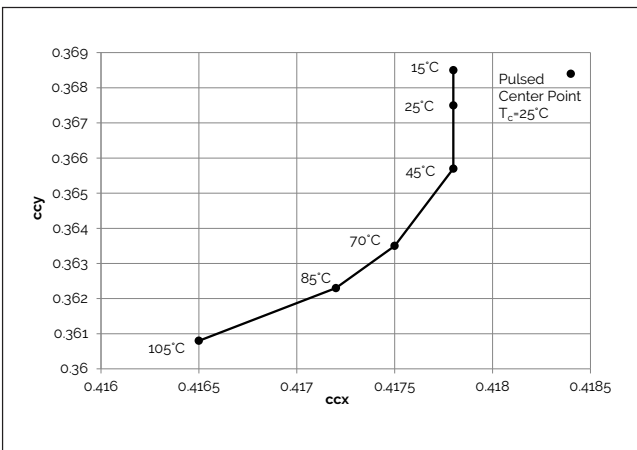

**Figure 13: 3500K Class A Color Shift vs. Case Temperature<sup>1</sup>**

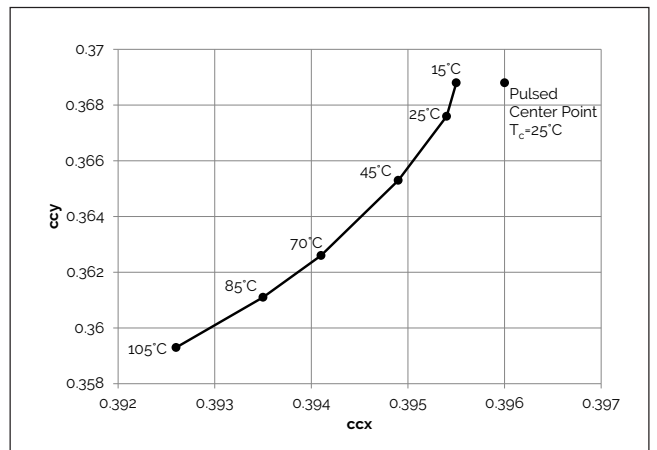

Note for Figures 8-12:

1. Measurements made under DC test conditions at the nominal drive current.
2. Typical color shift is shown with a tolerance of  $\pm 0.002$ .
3. Characteristics shown for Decor Series Showcase products, BXRE-30G200C-x-73

# Typical Radiation Pattern

Figure 13: Typical Spatial Radiation Pattern

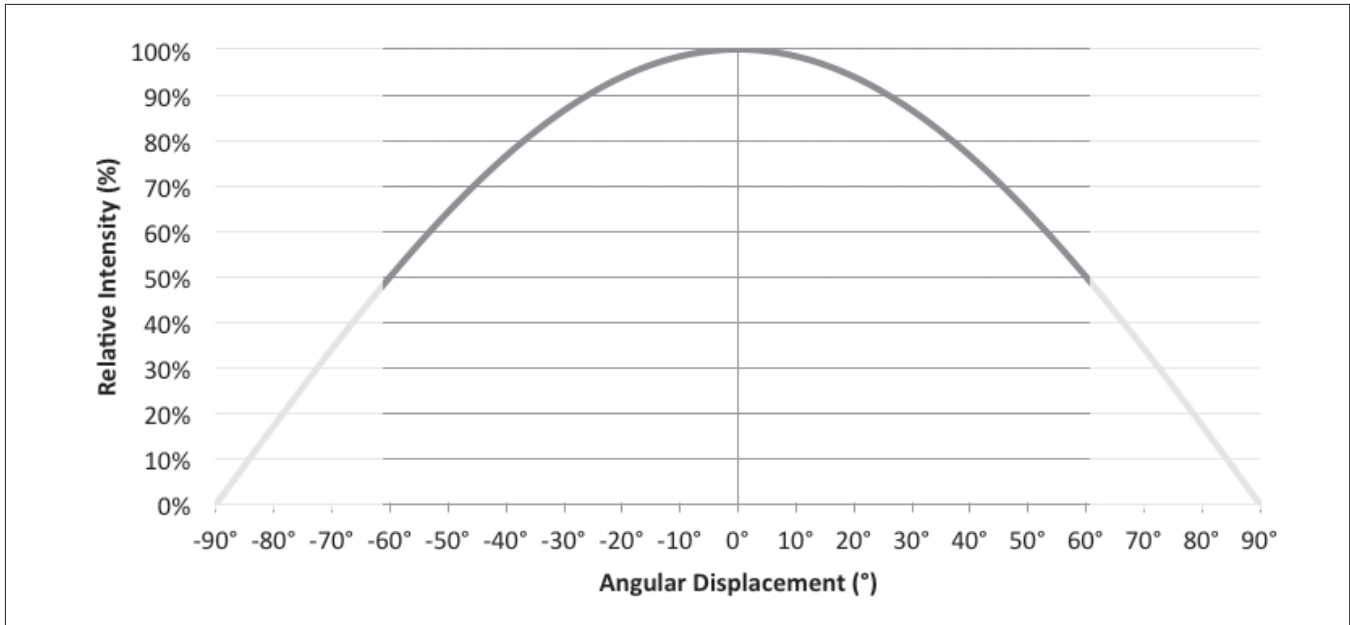

Note for Figure 13:

1. Typical viewing angle is 120°.
2. The viewing angle is defined as the off axis angle from the centerline where intensity is ½ of the peak value.

Figure 14: Typical Polar Radiation Pattern

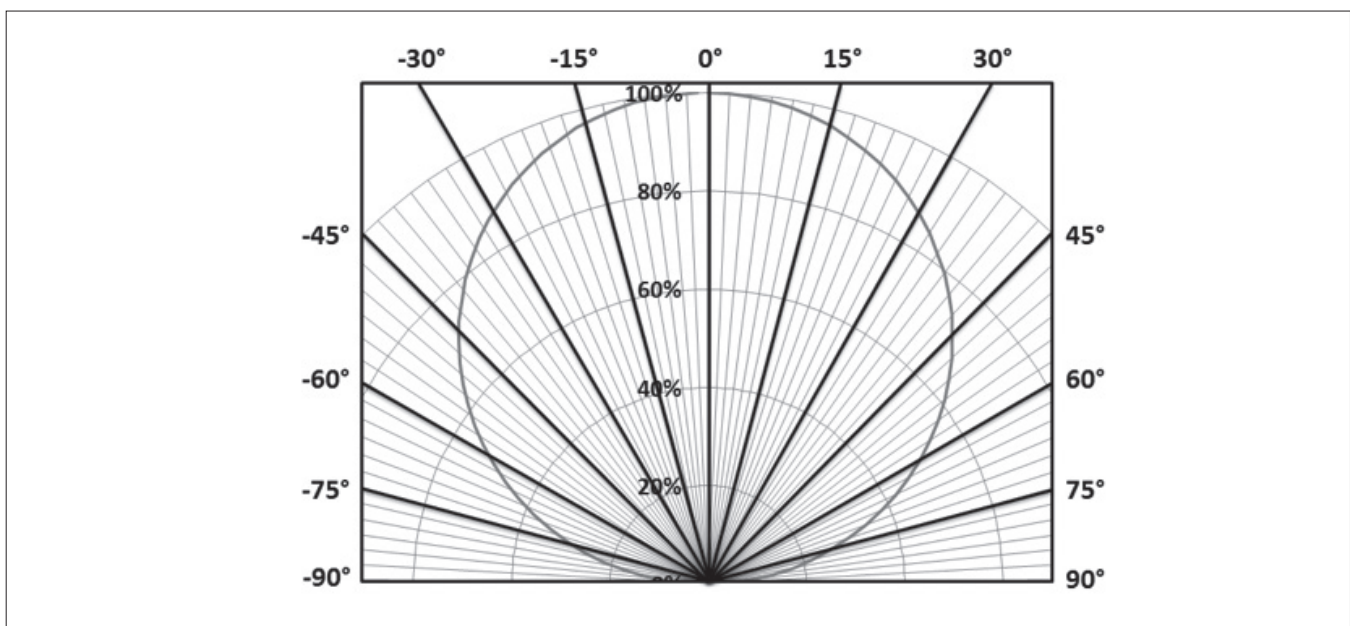

# Typical Color Spectrum

Figure 15: Typical Color Spectrum

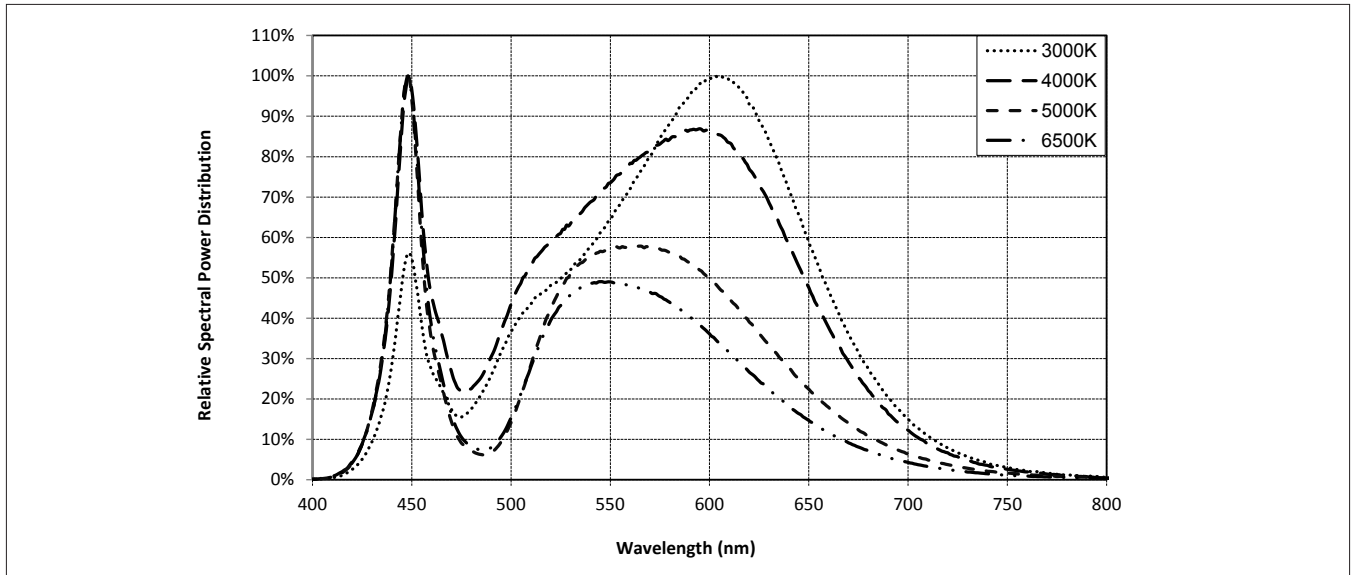

Note for Figure 15:

1. Color spectra measured at nominal current for  $T_j = T_c = 25^\circ\text{C}$ .
2. Color spectra shown is 3000K and 80 CRI.
3. Color spectra shown is 4000K and 80 CRI.
4. Color spectra shown is 5000K and 70 CRI.
4. Color spectra shown is 6500K and 70 CRI.

Figure 16: Typical Color Spectrum for Décor Series

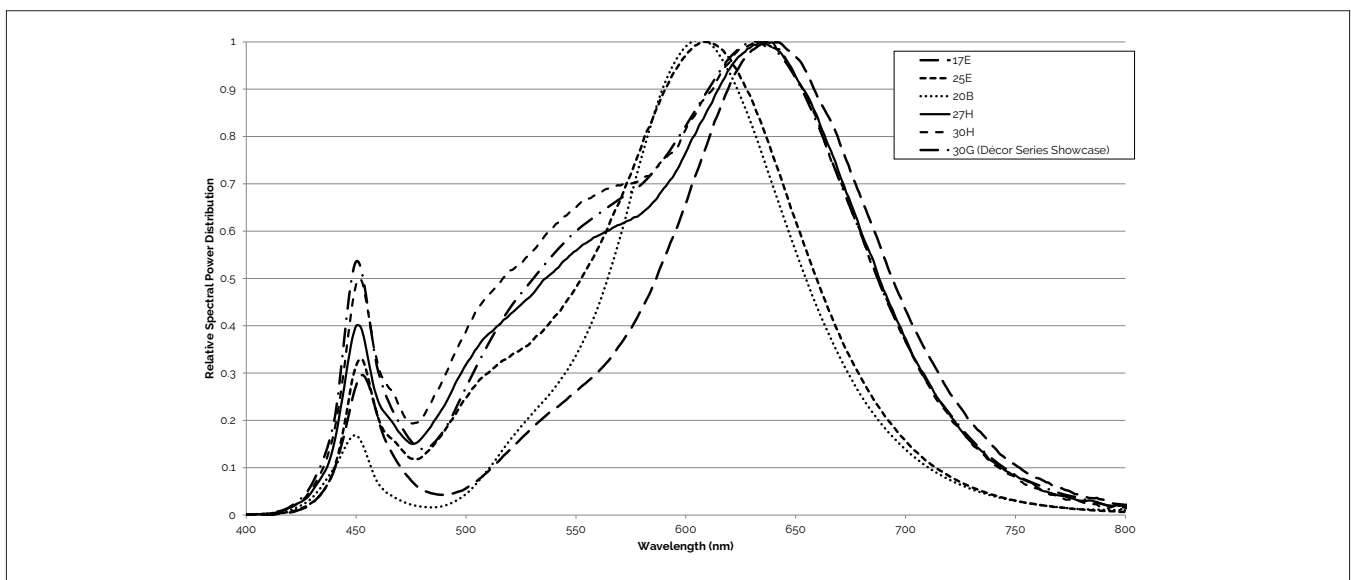

Note for Figure 16:

1. Color spectra measured at nominal current for  $T_j = T_c = 25^\circ\text{C}$ .

# Mechanical Dimensions

Figure 17: Drawing for V13 LED Array

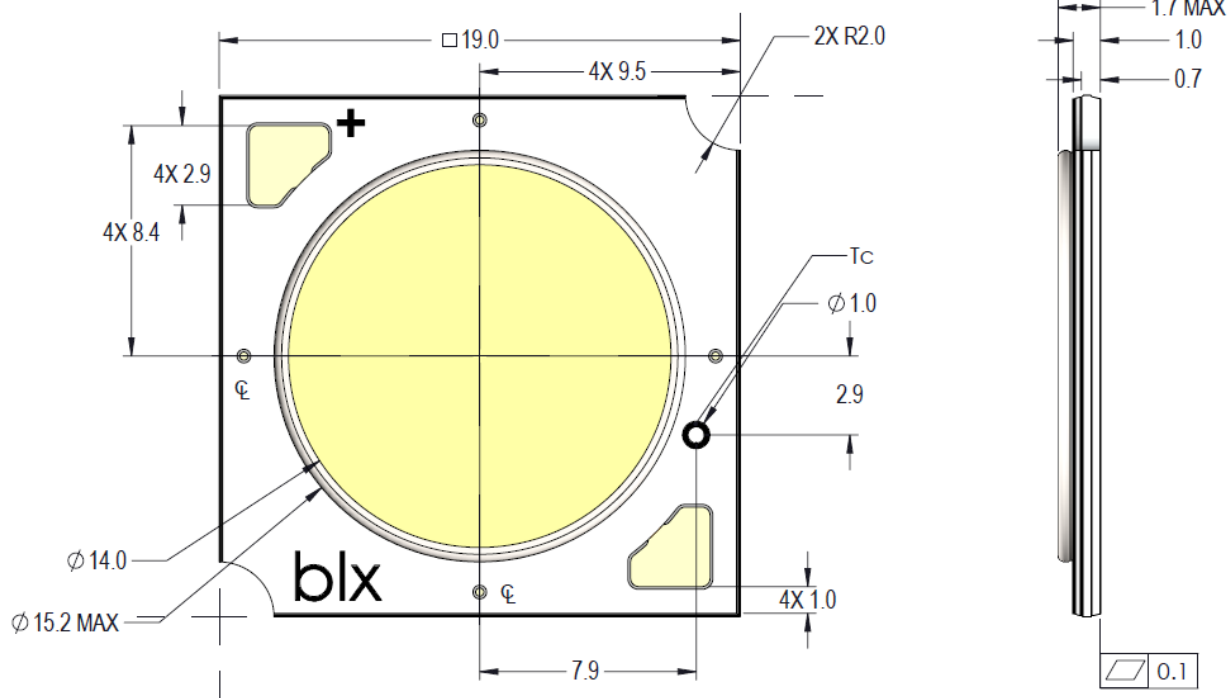

Notes for Figure 17:

1. Drawings are not to scale.
2. Drawing dimensions are in millimeters.
3. Unless otherwise specified, tolerances are  $\pm 0.1\text{mm}$ .
4. Solder pad labeled "+" denotes positive contact.
5. Refer to Application Notes AN101 for product handling, mounting and heat sink recommendations.
6. The optical center of the LED Array is nominally defined by the mechanical center of the array to a tolerance of  $\pm 0.2\text{mm}$ .
7. Bridgelux maintains a flatness of 0.10mm across the mounting surface of the array.



# Color Binning Information

**Figure 18: Warm and Neutral White Test Bins in xy Color Space**

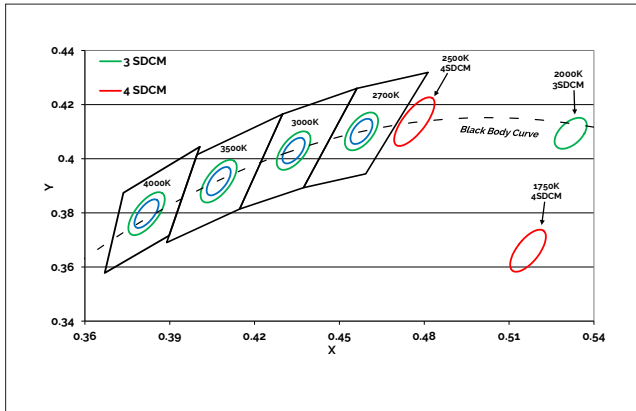

Note: Pulsed Test Conditions,  $T_c = 25^\circ\text{C}$

**Figure 19: Cool White Test Bins in xy Color Space**

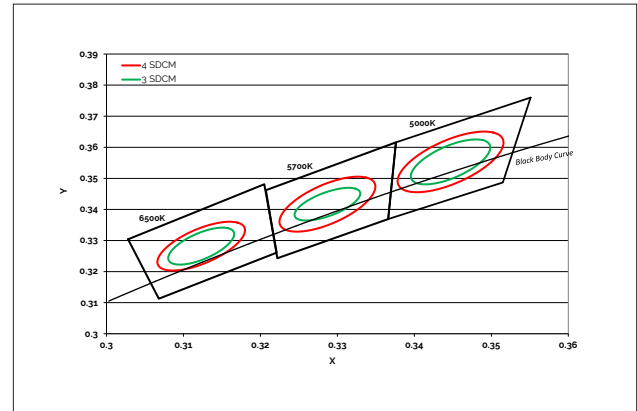

**Table 8: Warm and Neutral White xy Bin Coordinates and Associated Typical CCT**

Bin Code	1750K	2000K	2500K	2700K	3000K <sup>1</sup>	3500K <sup>1</sup>	4000K <sup>1</sup>
ANSI Bin (for reference only)	-	-	-	(2580K - 2870K)	(2870K - 3220K)	(3220K - 3710K)	(3710K - 4260K)
73 (3 SDCM)	-	-	-	(2651K - 2794K)	(2968K - 3136K)	(3369K - 3586K)	(3851K - 4130K)
72 (2 SDCM)	-	-	-	(2674K - 2769K)	(2995K - 3107K)	(3404K - 3548K)	(3895K - 4081K)
Center Point (x,y)	(0.5167, 0.336)	(0.5280, 0.4100)	(0.4765, 0.4137)	(0.4578, 0.4101)	(0.4338, 0.403) (0.4465, 0.4024) <sup>2</sup>	(0.4073, 0.3917)	(0.3818, 0.3797)

Note for Table 8:

1. Color Binning information excludes Décor Series Class A products. Please contact your Bridgelux Sales Representative for more information.
2. Center Point for Décor Series Showcase.

**Table 9: Cool White xy Bin Coordinates and Associated Typical CCT (product is hot targeted to  $T_c = 85^\circ\text{C}$ )**

Bin Code	5000K	5700K	6500K
ANSI Bin (for reference only)	(4745K - 5311K)	(5312K - 6022K)	(6022K - 7042K)
74 (4 SDCM)	(4801K - 5282K)	(5829K - 5481K)	(6270K - 6765K)
73 (3 SDCM)	(4835K - 5215K)	(4590K - 5820K)	(6250K - 6745K)
Center Point (x,y)	(0.3447, 0.3553)	(0.3287, 0.3417)	(0.3123, 0.3282)

# Packaging and Labeling

Figure 20: Drawing for V13 Packaging Tray



Notes for Figure 20:

1. Each tube holds 25 V13 COB arrays.
2. One tube is sealed in an anti-static bag. Four bags are placed in a shipping box. Depending on quantities ordered, a bigger shipping box, containing four boxes may be used to ship products.
3. Each bag and box is to be labeled as shown above.
4. Dimensions for each tube are 21.3 (W) x 9.5(H) x 505 (L). Dimensions for the anti-static bag are 75 (W) x 615 (L) x 3.1 (T) mm. Dimensions for the shipping box are 58.7 x 13.3 x 7.9 cm.

# Packaging and Labeling

**Figure 21: Gen. 7 Product Labeling**

Bridgelux COB arrays have laser markings on the back side of the substrate to help with product identification. In addition to the product identification markings, Bridgelux COB arrays also contain markings for internal Bridgelux manufacturing use only. The image below shows which markings are for customer use and which ones are for Bridgelux internal use only. The Bridgelux internal manufacturing markings are subject to change without notice, however these will not impact the form, function or performance of the COB array.



# Design Resources

## Application Notes

Bridgelux has developed a comprehensive set of application notes and design resources to assist customers in successfully designing with the V Series product family of LED array products. For all available application notes visit [www.bridgelux.com](http://www.bridgelux.com).

## Optical Source Models

Optical source models and ray set files are available for all Bridgelux products. For a list of available formats, visit [www.bridgelux.com](http://www.bridgelux.com).

## 3D CAD Models

Three dimensional CAD models depicting the product outline of all Bridgelux V Series LED arrays are available in both IGS and STEP formats. Please contact your Bridgelux sales representative for assistance.

## LM80

LM80 testing has been completed and the LM80 report is now available. Please contact your Bridgelux sales representative for LM-80 report.

# Precautions

## CAUTION: CHEMICAL EXPOSURE HAZARD

Exposure to some chemicals commonly used in luminaire manufacturing and assembly can cause damage to the LED array. Please consult Bridgelux Application Note AN101 for additional information.

## CAUTION: RISK OF BURN

Do not touch the V Series LED array during operation. Allow the array to cool for a sufficient period of time before handling. The V Series LED array may reach elevated temperatures such that could burn skin when touched.

## CAUTION

### CONTACT WITH LIGHT EMITTING SURFACE (LES)

Avoid any contact with the LES. Do not touch the LES of the LED array or apply stress to the LES (yellow phosphor resin area). Contact may cause damage to the LED array.

Optics and reflectors must not be mounted in contact with the LES (yellow phosphor resin area).

# Disclaimers

## MINOR PRODUCT CHANGE POLICY

The rigorous qualification testing on products offered by Bridgelux provides performance assurance. Slight cosmetic changes that do not affect form, fit, or function may occur as Bridgelux continues product optimization.

## STANDARD TEST CONDITIONS

Unless otherwise stated, array testing is performed at the nominal drive current.

# About Bridgelux: Bridging Light and Life™

At Bridgelux, we help companies, industries and people experience the power and possibility of light. Since 2002, we've designed LED solutions that are high performing, energy efficient, cost effective and easy to integrate. Our focus is on light's impact on human behavior, delivering products that create better environments, experiences and returns—both experiential and financial. And our patented technology drives new platforms for commercial and industrial luminaires.

**For more information about the company, please visit**  
**bridgelux.com**  
**twitter.com/Bridgelux**  
**facebook.com/Bridgelux**  
**youtube.com/user/Bridgelux**  
**linkedin.com/company/bridgelux-inc-\_2**  
**WeChat ID: BridgeluxInChina**



46430 Fremont Boulevard  
Fremont, CA 94538 U.S.A.  
Tel (925) 583-8400  
[www.bridgelux.com](http://www.bridgelux.com)

© 2018 Bridgelux, Inc. All rights reserved 2018. Product specifications are subject to change without notice. Bridgelux, the Bridgelux stylized logo design and Vero are registered trademarks, and Decor Series is a trademark of Bridgelux, Inc. All other trademarks are the property of their respective owners.

Bridgelux Gen 7 V13 Array Series Product Data Sheet DS101 Rev. M (11/2018)

单击下面可查看定价，库存，交付和生命周期等信息

[>>Bridgelux\(普瑞光电\)](#)