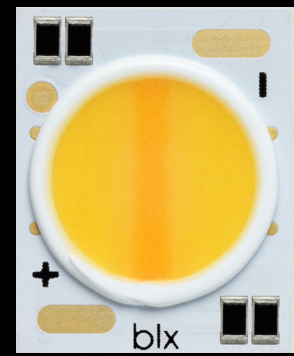


# Bridgelux® Vesta™ Series Dim-To-Warm 9mm Array

Product Data Sheet DS150

# Introduction

Vesta™ Series



Vesta™ Series Dim-To-Warm Array products deliver adaptable light in a cost-effective, solid state lighting package. Vesta™ Series products tap into the powerful mediums of light and color to influence experience, well-being, and human emotion. They allow fixture manufacturers to simulate the familiar glow and dimming of incandescent lamps. This high flux density light source is designed to support a wide range of high quality, low cost directional luminaires and replacement lamps for commercial and residential applications.

Lighting system designs incorporating these LED arrays deliver comparable performance to 150 Watt incandescent-based luminaires, while increasing system level efficacy and prolonging service life. Typical luminaire and lamp types appropriate for this family include replacement lamps, down lights, wall packs and accent, spot and track lights.

## Features

- Dimming range from 3000K to 1800K
- Efficacy of 96-97 lm/W typical
- Uniform, high quality illumination
- Minimum 95 CRI option
- More energy efficient than incandescent, halogen and fluorescent lamps
- Industry standardized dimensions
- Flux packages from 570 to 1400 lumens typical

## Benefits

- Superior color dimming transition
- Compact system design resulting from high lumen density
- High quality, true color reproduction
- Enhanced optical control
- Uniform, consistent white light
- Lower operating costs
- Reduced maintenance costs

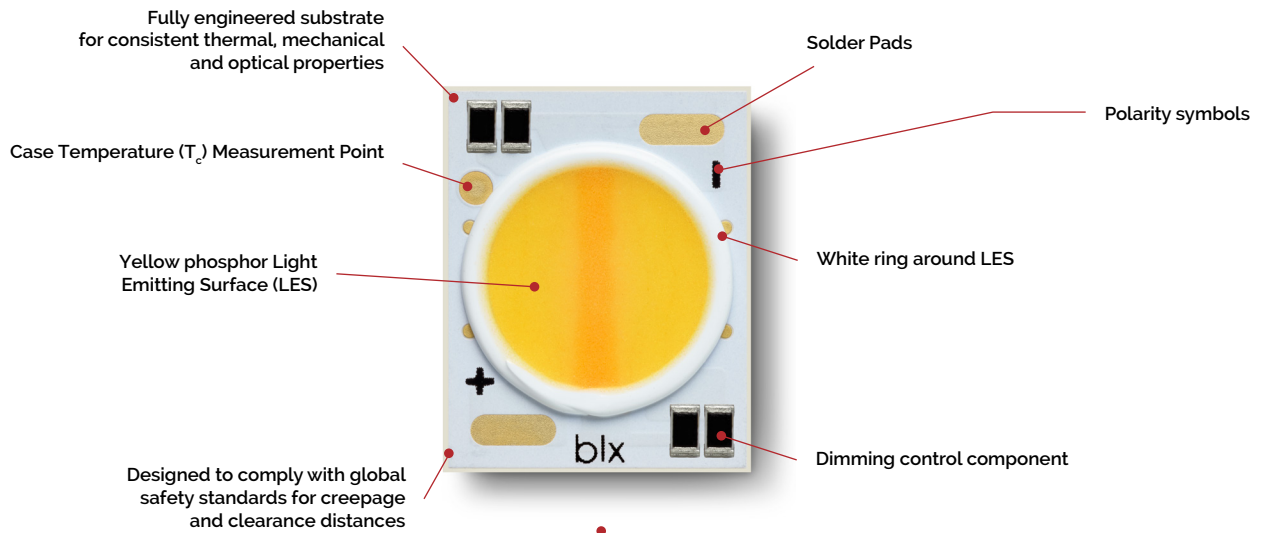


# Contents

Product Feature Map	2
Product Nomenclature	2
Product Selection Guide	3
Electrical Characteristics	4
Absolute Maximum Ratings	5
Performance Curves	6
Typical Radiation Pattern	8
Typical Color Spectrum	9
Mechanical Dimensions	10
Color Binning Information	11
Packaging and Labeling	12
Design Resources	13
Precautions	13
Disclaimers	13
About Bridgelux	14

# Product Feature Map

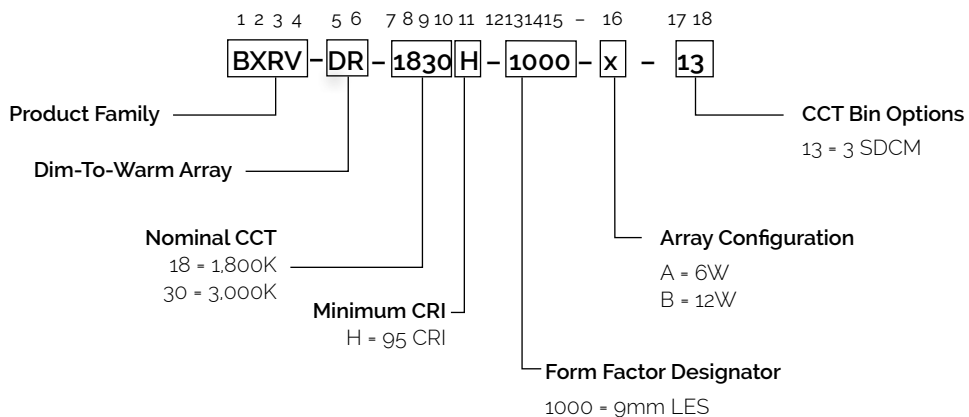
Bridgelux arrays are fully engineered devices that provide consistent thermal and optical performance on an engineered mechanical platform. The arrays incorporate several features to simplify design integration and assembly. Please visit [www.bridgelux.com](http://www.bridgelux.com) for more information on the Vesta Series Family of products.



Note: Part number and lot codes are scribed on back of array

## Product Nomenclature

The part number designation for Bridgelux Vesta Series arrays is explained as follows:



# Product Selection Guide

The following product configurations are available:

**Table 1:** Selection Guide, Measurement Data ( $T_j = T_c = 25^\circ\text{C}$ )

Part Number	Nominal CCT <sup>1</sup> (K)	CRI <sup>2</sup>	Drive Current (mA)	Typical $V_f$ $T_c=25^\circ\text{C}$ (V)	Typical Power $T_c=25^\circ\text{C}$ (W)	Typical Efficacy $T_c=25^\circ\text{C}$ (lm/W)	Typical Pulsed Flux <sup>3,4,5</sup> $T_c=25^\circ\text{C}$ (lm)	Minimum Pulsed Flux <sup>6,7</sup> $T_c=25^\circ\text{C}$ (lm)	Typical DC Flux <sup>7,8</sup> $T_c=85^\circ\text{C}$ (lm)
BXRV-DR-1830H-1000-A-13	3000	95	350	17.0	6.0	96	570	513	518
	1800	95	14	11.2	0.2	83	13	-	12
BXRV-DR-1830H-1000-B-13	3000	95	350	33.8	11.8	97	1150	1035	1045
	1800	95	14	26.9	0.4	82	31	-	28

**Notes for Table 1:**

- Nominal CCT as defined by ANSI C78.377-2011.
- CRI Values are minimums. Minimum Rg value for 95 CRI products is 85. Bridgelux maintains a  $\pm 3$  tolerance on all Rg values.
- Products tested under pulsed condition (10ms pulse width) at nominal test current where  $T_j$  (junction temperature) -  $T_c$  (case temperature) =  $25^\circ\text{C}$ .
- Typical performance values are provided as a reference only and are not a guarantee of performance.
- Bridgelux maintains a  $\pm 7\%$  tolerance on flux measurements.
- Minimum flux values at the nominal test current are guaranteed by 100% test.
- Typical stabilized DC performance values are provided as reference only and are not a guarantee of performance.
- Typical performance is estimated based on operation under DC (direct current) with LED array mounted onto a heat sink with thermal interface material and the case temperature maintained at  $85^\circ\text{C}$ . Based on Bridgelux test setup, values may vary depending on the thermal design of the luminaire and/or the exposed environment to which the product is subjected.

# Electrical Characteristics

**Table 2:** Electrical Characteristics

Part Number	Drive Current (mA)	Forward Voltage Pulsed, $T_c = 25^\circ\text{C}$ (V) <sup>1, 2, 3</sup>			Typical Coefficient of Forward Voltage $\Delta V_f / \Delta T_c$ (mV/ $^\circ\text{C}$ )	Typical Thermal Resistance Junction to Case <sup>4, 5</sup> $R_{j-c}$ ( $^\circ\text{C}/\text{W}$ )	Driver Selection Voltages <sup>6</sup> (V)	
		Minimum	Typical	Maximum			$V_f$ Min. Hot $T_c = 105^\circ\text{C}$ (V)	$V_f$ Max. Cold $T_c = -40^\circ\text{C}$ (V)
BXRV-DR-1830H-1000-A-13	350	15.5	17.0	18.5	-6.1	0.89	15.0	18.9
	420	15.8	17.3	18.8	-6.1	0.92	15.3	19.2
BXRV-DR-1830H-1000-B-13	350	30.6	33.8	37.0	-12.1	0.41	29.6	37.8
	420	31.2	34.4	37.6	-12.1	0.42	30.2	38.4

Notes for Table 2:

- Parts are tested in pulsed conditions.  $T_c = 25^\circ\text{C}$ . Pulse width is 10ms.
- Voltage minimum and maximum are provided for reference only and are not a guarantee of performance.
- Bridgelux maintains a tester tolerance of  $\pm 0.10\text{V}$  on forward voltage measurements.
- Typical coefficient of forward voltage tolerance is  $\pm 0.1\text{mV}$  for nominal current.
- Thermal resistance value was calculated using total electrical input power; optical power was not subtracted from input power. The thermal interface material used during testing is not included in the thermal resistance value.
- $V_f$  min hot and max cold values are provided as reference only and are not guaranteed by test. These values are provided to aid in driver design and selection over the operating range of the product.

# Absolute Maximum Ratings

**Table 3:** Maximum Ratings

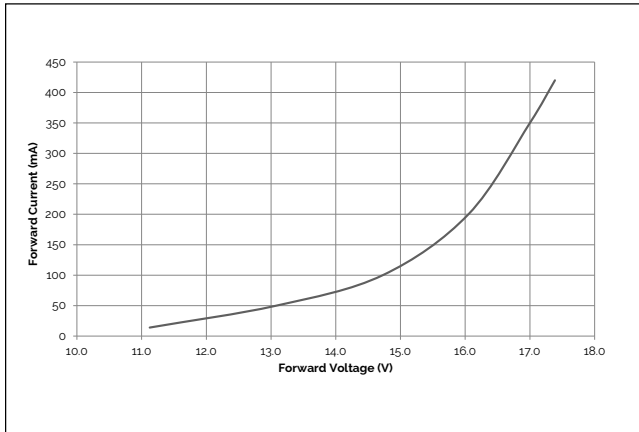
Parameter	Maximum Rating	
LED Junction Temperature ( $T_j$ )	125°C	
Storage Temperature	-40°C to +105°C	
Operating Case Temperature <sup>1</sup> ( $T_c$ )	105°C	
Soldering Temperature <sup>2</sup>	350°C or lower for a maximum of 10 seconds	
Maximum Drive Current <sup>3</sup>	420mA	
Maximum Peak Pulsed Drive Current <sup>4</sup>	600mA	
	BXRV-DR-1830H-1000-A-13	BXRV-DR-1830H-1000-B-13
Maximum Reverse Voltage <sup>5</sup>	-30V	-60V

Notes for Table 3:

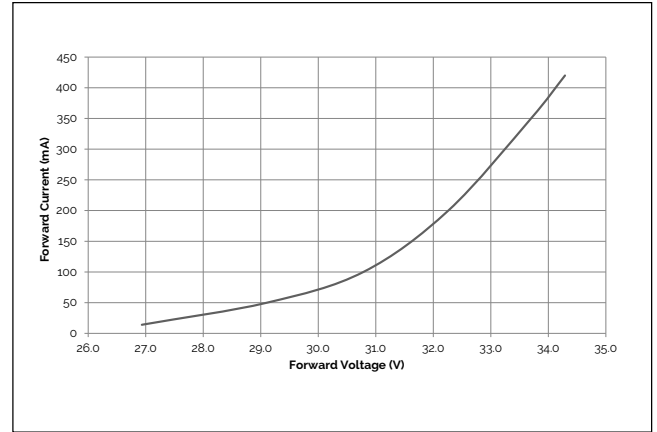
1. For IEC 62717 requirement, please contact Bridgelux Sales Support.
2. See Bridgelux Application Note for more information.
3. Please refer to Figure 11 for drive current derating curve.
4. Bridgelux recommends a maximum duty cycle of 10% and pulse width of 20ms when operating LED arrays at the maximum peak pulsed current specified. Maximum peak pulsed currents indicate values where the LED array can be driven without catastrophic failures.
5. Light emitting diodes are not designed to be driven in reverse voltage and will not produce light under this condition. Maximum rating provided for reference only.

# Performance Curves

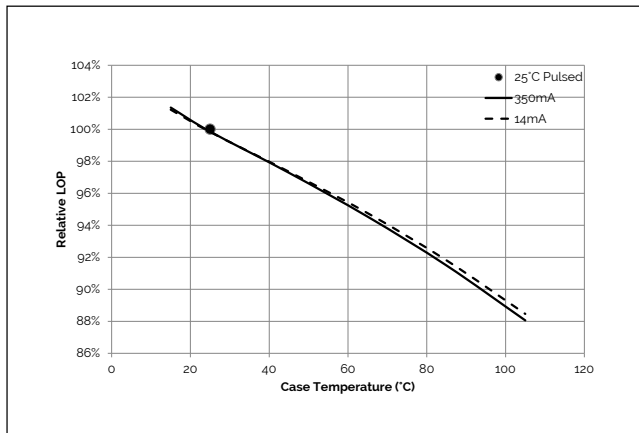
**Figure 1: 6W Forward Voltage vs. Forward Current,  $T_c=25^\circ\text{C}$**



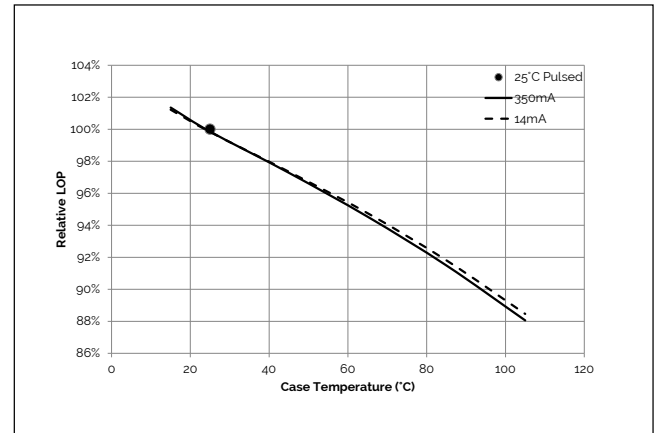
**Figure 2: 12W Forward Voltage vs. Forward Current,  $T_c=25^\circ\text{C}$**



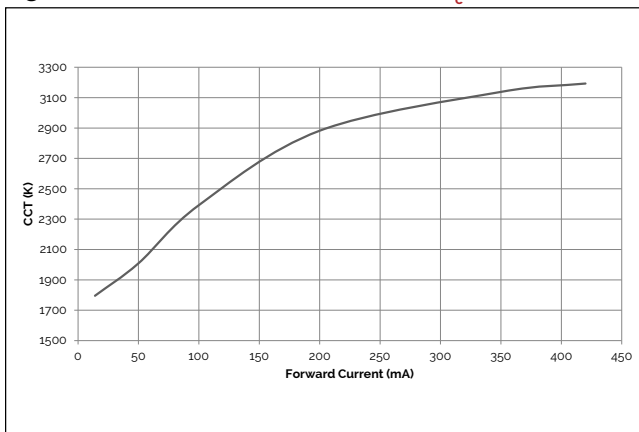
**Figure 3: 6W Relative Flux vs. Case Temperature**



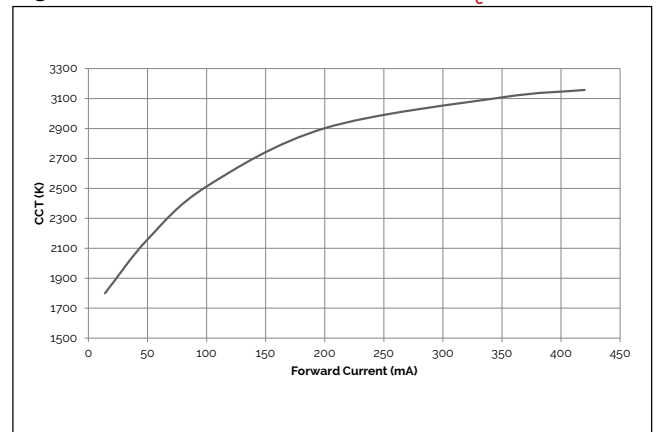
**Figure 4: 12W Relative Flux vs. Case Temperature**



**Figure 5: 6W CCT vs. Forward Current,  $T_c=25^\circ\text{C}$**



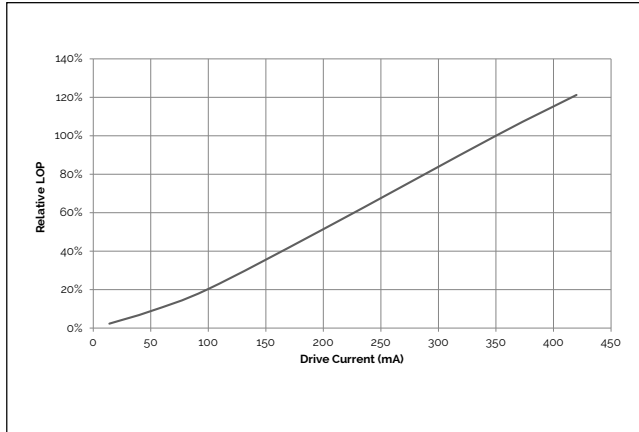
**Figure 6: 12W CCT vs. Forward Current,  $T_c=25^\circ\text{C}$**



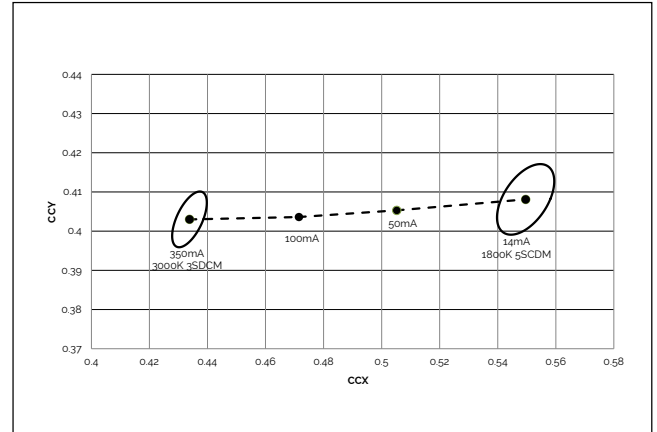


# Performance Curves

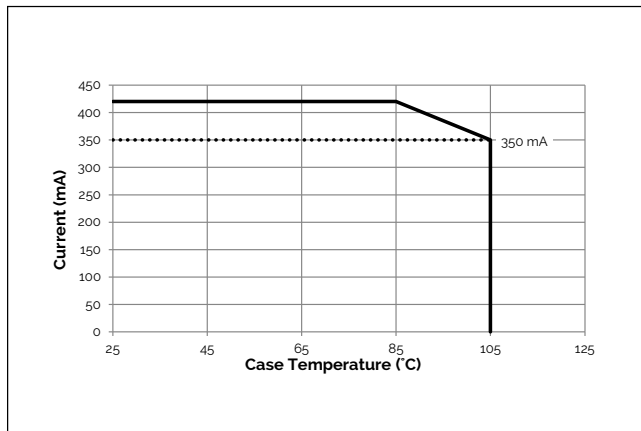
**Figure 7: Relative LOP vs. Drive Current,  $T_c=25^\circ\text{C}$**



**Figure 8: Color shift vs. Forward Current**

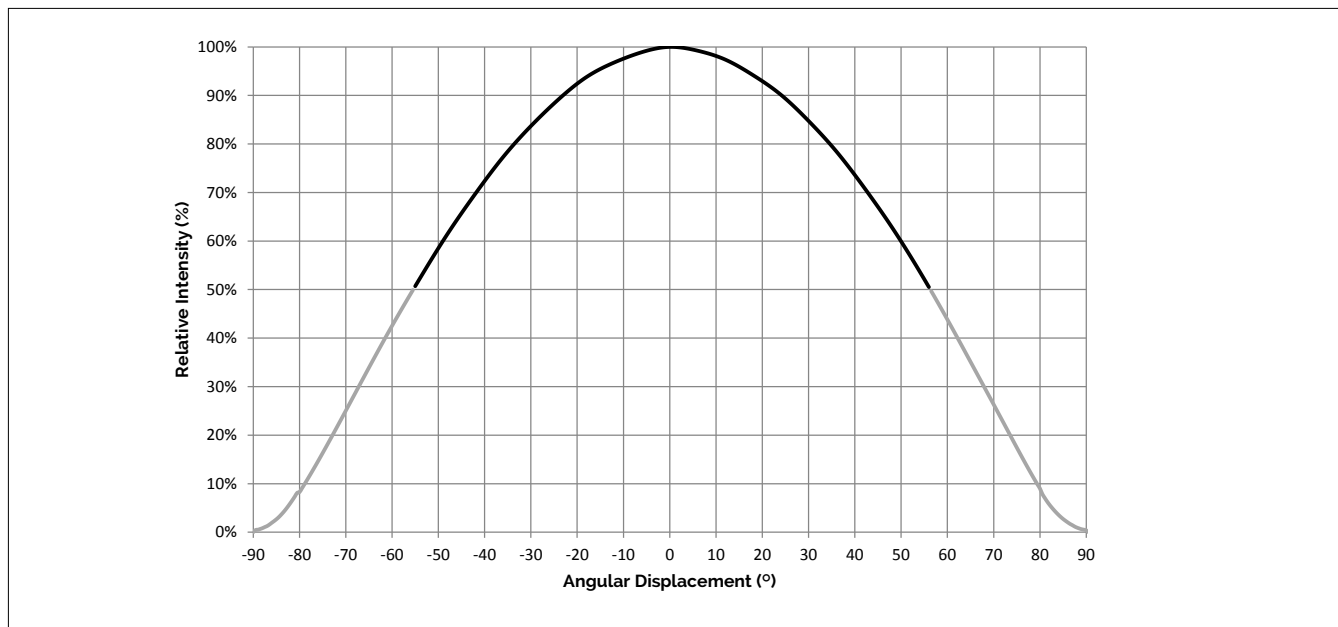


**Figure 9: Derating Curve**



# Typical Radiation Pattern

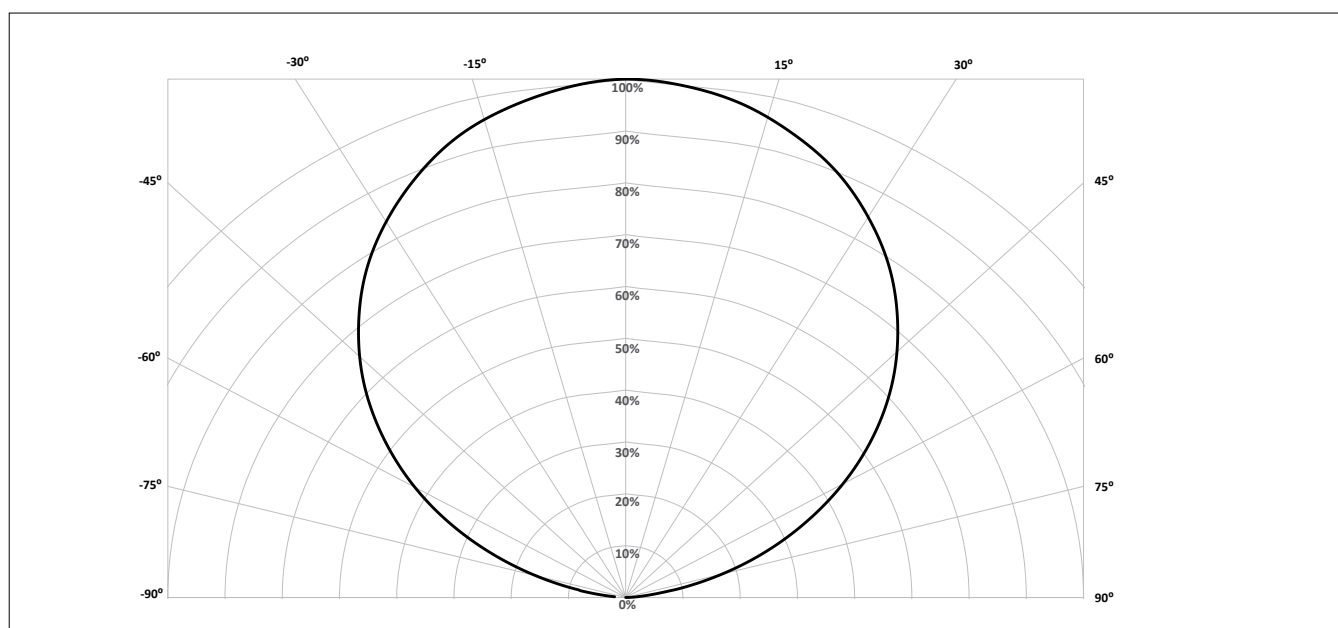
**Figure 10: Typical Spatial Radiation Pattern**



Notes for Figure 10:

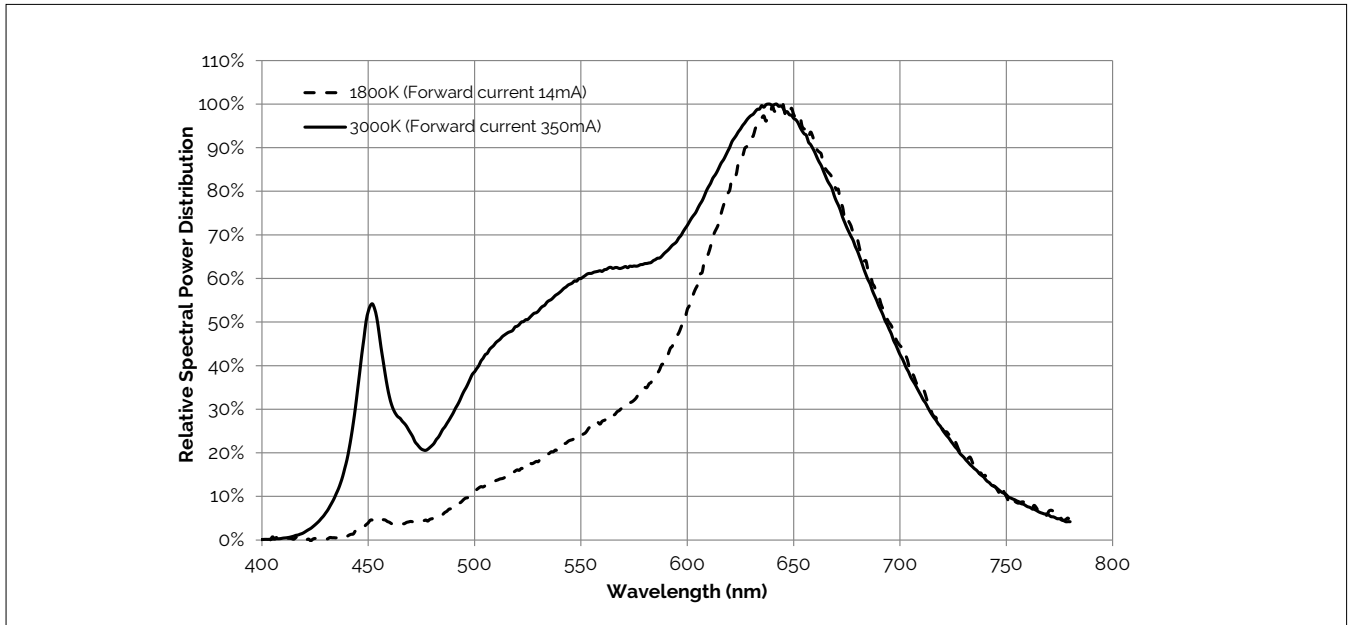
1. Typical viewing angle is 110°.
2. The viewing angle is defined as the off axis angle from the centerline where  $I_v$  is  $\frac{1}{2}$  of the peak value.

**Figure 11: Typical Polar Radiation Pattern**



# Typical Color Spectrum

Figure 12: Typical Color Spectrum

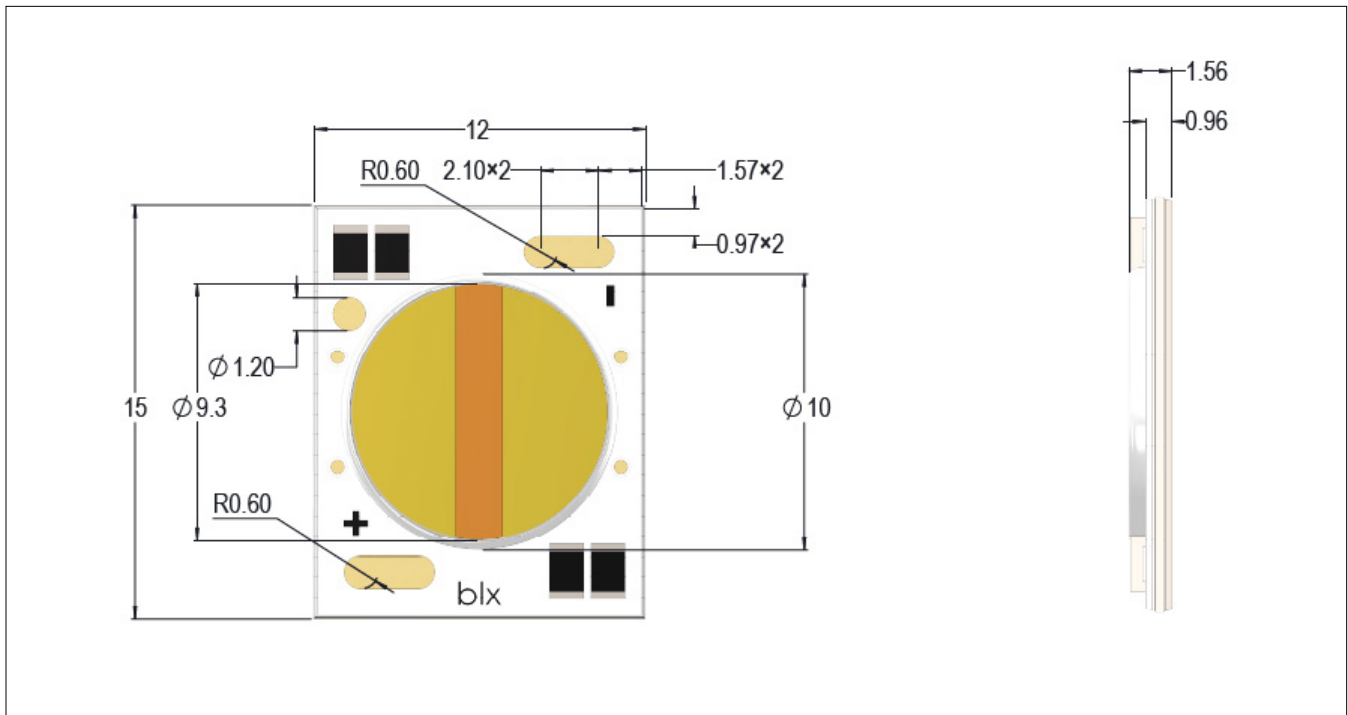


Note for Figure 12:

1. Color spectra measured at nominal current for  $T_j = T_c = 25^\circ\text{C}$ .

# Mechanical Dimensions

**Figure 13: Drawing for Vesta™ Dim-To-Warm gmm Array**

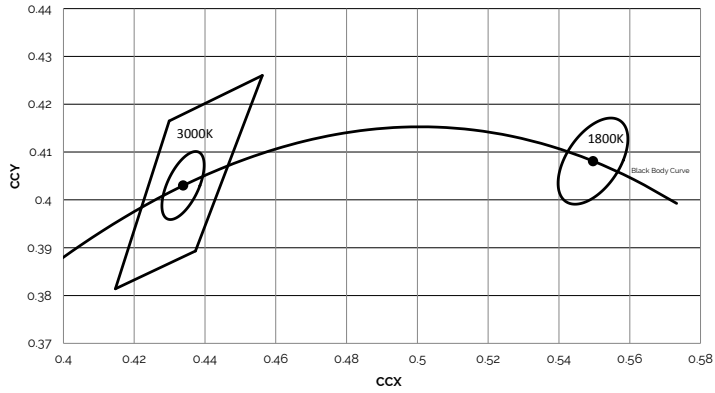


Notes for Figure 13:

1. Solder pads are labeled "+" to denote positive polarity, and "-" to denote negative polarity.
2. Drawings are not to scale.
3. Drawing dimensions are in millimeters.
4. Unless otherwise specified, tolerances are  $\pm 0.10\text{mm}$ .
5. The optical center of the LED array is nominally defined by the mechanical center of the array. The light emitting surface (LES) is centered on the mechanical center of the array to a tolerance of  $\pm 0.2\text{ mm}$ .
6. Bridgelux maintains a flatness of 0.1 mm across the mounting surface of the array. Refer to Application Notes for product handling, mounting and heat sink recommendations.

# Color Binning Information

**Figure 14: Graph of Warm White Test Bins in xy Color Space**



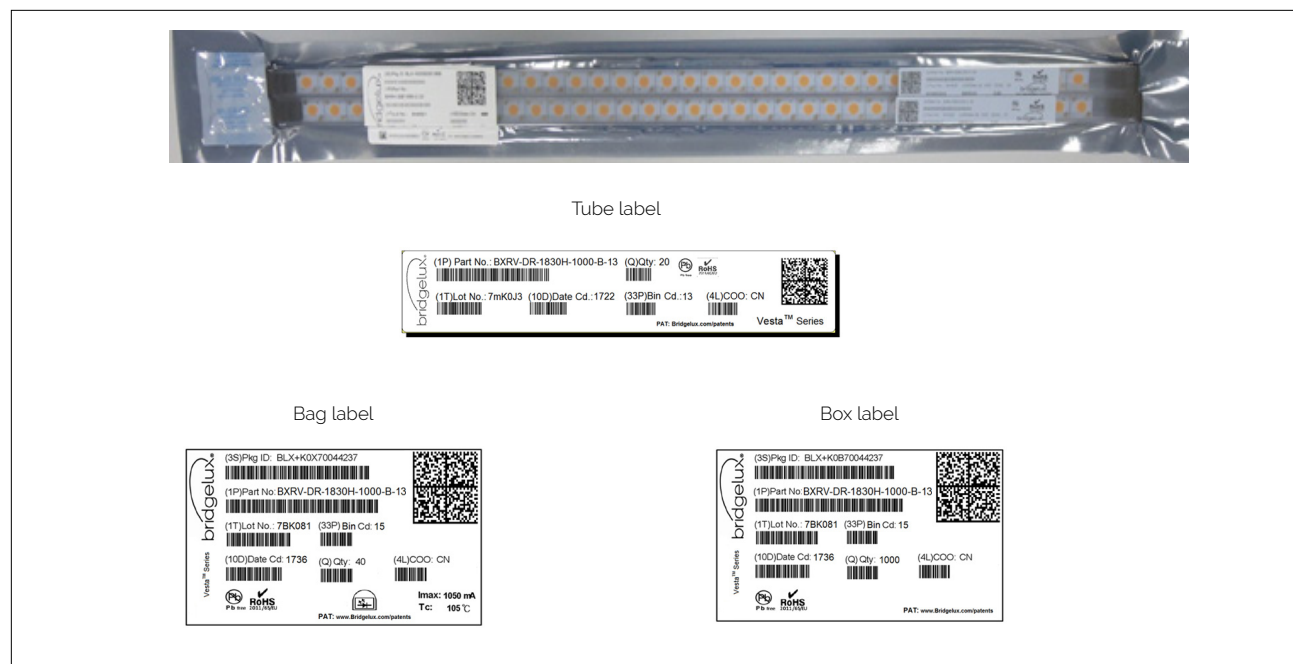
Note: Pulsed Test Conditions,  $T_c = 25^\circ\text{C}$

**Table 4: Bin Coordinates and Associated Typical CCT**

Bin Code	3000K	1800K
ANSI Bin (for reference only)	(2870K - 3220K)	-
3 (3SDCM)	(2968K - 3136K)	-
5 (5SDCM)	-	(1735K - 1880K)
Center Point (x,y)	(0.4338, 0.403)	(0.5496, 0.4081)

# Packaging and Labeling

**Figure 15: Vesta™ Series Dim-To-Warm gmm Packaging and Labeling**



Notes for Figure 15:

1. Each tube holds 35 Vesta™ Series Dim-To-Warm gmm arrays.
2. Two tubes are sealed in an anti-static bag. Ten such bags are placed in a box and shipped. Depending on quantities ordered, a bigger shipping box containing four boxes will be used to ship products.
3. Each bag and box is to be labeled as shown above.
4. Dimensions for each tube are 15,4 (W) x 8,3(H) x 500 (L) mm. Dimensions for the anti-static bag are 75 (W) x 615 (L) x 3,1 (T) mm and that of a shipping box are 58,7 x 13,3 x 7,9 cm.

**Figure 16: Product Labeling**

Bridgelux arrays have laser markings on the back side of the substrate to help with product identification. In addition to the product identification markings, Bridgelux arrays also contain markings for internal Bridgelux manufacturing use only. The image below shows which markings are for customer use and which ones are for Bridgelux internal use only. The Bridgelux internal manufacturing markings are subject to change without notice, however these will not impact the form, function or performance of the array.



# Design Resources

## Application Notes

Bridgelux has developed a comprehensive set of application notes and design resources to assist customers in successfully designing with the Vesta Series product family of LED array products. For a list of resources under development, visit [www.bridgelux.com](http://www.bridgelux.com).

## Optical Source Models

Optical source models and ray set files are available for all Bridgelux products. For a list of available formats, visit [www.bridgelux.com](http://www.bridgelux.com).

## 3D CAD Models

Three dimensional CAD models depicting the product outline of all Bridgelux Vesta Series LED arrays are available in both IGES and STEP formats. Please contact your Bridgelux sales representative for assistance.

## LM80

LM80 testing is ongoing. Please contact your Bridgelux sales representative for more information.

# Precautions

## CAUTION: CHEMICAL EXPOSURE HAZARD

Exposure to some chemicals commonly used in luminaire manufacturing and assembly can cause damage to the LED array. Please consult Bridgelux Application Note for additional information.

## CAUTION: EYE SAFETY

Eye safety classification for the use of Bridgelux Vesta Series is in accordance with IEC/TR62778: Application of IEC 62471 for the assessment of blue light hazard to light sources and luminaires. Vesta Series Dim-To-Warm arrays are classified as Risk Group 1 when operated at or below the maximum drive current. Please use appropriate precautions. It is important that employees working with LEDs are trained to use them safely.

## CAUTION: RISK OF BURN

Do not touch the Vesta Series LED array during operation. Allow the array to cool for a sufficient period of time before handling. The Vesta Series LED array may reach elevated temperatures such that could burn skin when touched.

## CAUTION

### CONTACT WITH LIGHT EMITTING SURFACE (LES)

Avoid any contact with the LES. Do not touch the LES of the LED array or apply stress to the LES (yellow phosphor resin area). Contact may cause damage to the LED array.

Optics and reflectors must not be mounted in contact with the LES (yellow phosphor resin area). Optical devices may be mounted on the top surface of the Vesta Series LED array. Use the mechanical features of the LED array housing, edges and/or mounting holes to locate and secure optical devices as needed.

# Disclaimers

## STANDARD TEST CONDITIONS

Unless otherwise stated, array testing is performed at the nominal drive current.

## MINOR PRODUCT CHANGE POLICY

The rigorous qualification testing on products offered by Bridgelux provides performance assurance. Slight cosmetic changes that do not affect form, fit, or function may occur as Bridgelux continues product optimization.

# About Bridgelux: We Build Light That Transforms

At Bridgelux, we help companies, industries and people experience the power and possibility of light. Since 2002, we've designed LED solutions that are high performing, energy efficient, cost effective and easy to integrate. Our focus is on light's impact on human behavior, delivering products that create better environments, experiences and returns—both experiential and financial. And our patented technology drives new platforms for commercial and industrial luminaires.

**For more information about the company, please visit**

**[bridgelux.com](http://bridgelux.com)**

**[twitter.com/Bridgelux](https://twitter.com/Bridgelux)**

**[facebook.com/Bridgelux](https://facebook.com/Bridgelux)**

**[youtube.com/user/Bridgelux](https://youtube.com/user/Bridgelux)**

**[linkedin.com/company/bridgelux-inc-\\_2](https://linkedin.com/company/bridgelux-inc-_2)**

**WeChat ID: BridgeluxInChina**



46430 Fremont Blvd  
Fremont, CA 94538  
Tel (925) 583-8400  
Fax (925) 583-8410  
**[www.bridgelux.com](http://www.bridgelux.com)**

© 2017 Bridgelux, Inc. All rights reserved 2017. Product specifications are subject to change without notice. Bridgelux and the Bridgelux stylized logo design are registered trademarks of Bridgelux, Inc. and Vesta Series is a trademark of Bridgelux, Inc. All other trademarks are the property of their respective owners.

**Bridgelux Vesta Series Dim-To-Warm 9mm Array Product Data Sheet DS150 Rev. A (06/2017)**



单击下面可查看定价，库存，交付和生命周期等信息

[>>Bridgelux\(普瑞光电\)](#)