

Bridgelux® SMD 5050 Gen2 5W 36V

Product Data Sheet DS69

Introduction

SMD 5050

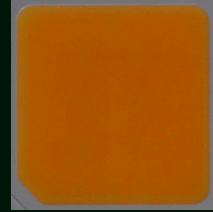

The Bridgelux SMD 5050 Gen2 high power LED is hot-color targeted, which ensures that the LEDs fall within their specified color bin at the typical application conditions of 85°C. With its broad lumen coverage and wide range of CCT options, the SMD 5050 provides unparalleled design-in flexibility for indoor and outdoor lighting applications. The SMD 5050 is ideal as a drop-in replacement for emitters with an industry standard 5.0mm x 5.0mm footprint.

Features

- Industry-standard 5050 footprint
- 3 bin color control enables tight color control
- Hot-color targeting ensures that color is within the ANSI bin at the typical application conditions of 85°C
- Enables 3- and 5-step MacAdam ellipse custom binning kits
- RoHS compliant and lead free
- Multiple CCT configurations for a wide range of lighting applications

Benefits

- Lower operating and manufacturing cost
- Ease of design and rapid go-to-market
- Uniform consistent white light
- Reliable and constant white point
- Environmentally friendly, complies with standards
- Design flexibility

Contents

Product Feature Map	2
Product Nomenclature	2
Product Test Conditions	2
Product Selection Guide	3
Performance at Commonly Used Drive Currents	5
Electrical Characteristics	9
Absolute Maximum Ratings	10
Product Bin Definitions	11
Performance Curves	14
Typical Radiation Pattern	17
Typical Color Spectrum	18
Mechanical Dimensions	19
Reliability	20
Reflowing Characteristics	21
Packaging	22
Design Resources	24
Precautions	24
Disclaimers	24
About Bridgelux	25

Product Feature Map

Bridgelux SMD LED products come in industry standard package sizes and follow ANSI binning standards. These LEDs are optimized for cost and performance, helping to ensure highly competitive system lumen per dollar performance while addressing the stringent efficacy and reliability standards required for modern lighting applications.

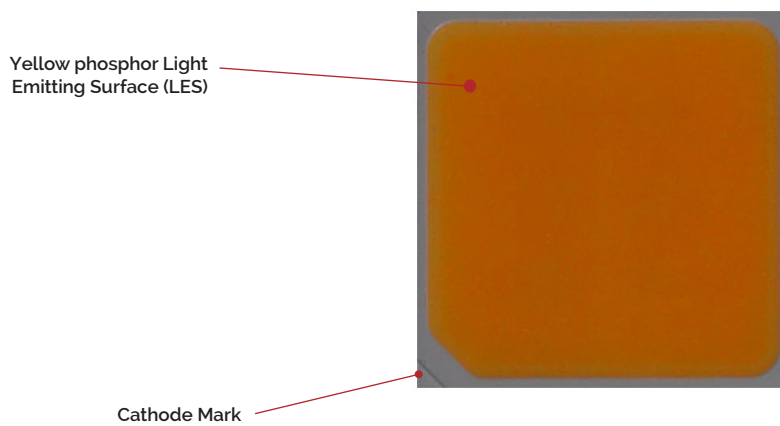

Product Nomenclature

The part number designation for Bridgelux SMD 5050 is explained as follows:

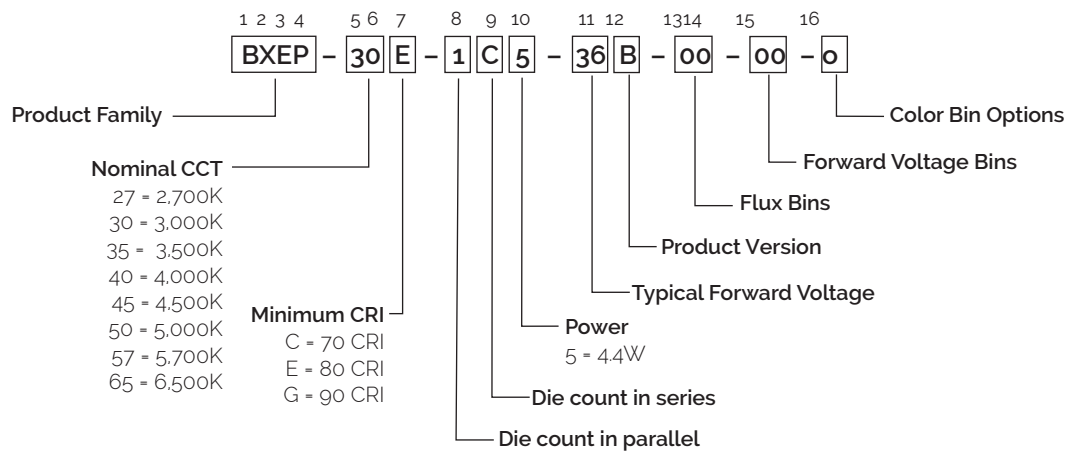

Product Test Conditions

Bridgelux SMD 5050 Gen2 LEDs are tested and binned with a 10ms pulse of 125mA at T_j (junction temperature) = T_{sp} (solder point temperature) = 25°C. Forward voltage and luminous flux are binned at a $T_j = T_{sp} = 25^\circ\text{C}$, while color is hot targeted at a T_{sp} of 85°C.

Product Selection Guide

The following product configurations are available:

Table 1: Selection Guide, Pulsed Measurement Data at 125mA ($T_j = T_{sp} = 25^\circ\text{C}$)

Part Number ⁶	Nominal CCT ² (K)	CRI ^{3,5}	Nominal Drive Current (mA)	Forward Voltage ^{4,5} (V)			Typical Pulsed Flux (lm) ^{4,5}	Typical Power (W)	Typical Efficacy (lm/W)
				Min	Typical	Max			
BXEP-27C-1C5-36B-00-00-0	2700	70	125	33.6	35.5	39.8	692	4.4	156
BXEP-27E-1C5-36B-00-00-0	2700	80	125	33.6	35.5	39.8	615	4.4	139
BXEP-27G-1C5-36B-00-00-0	2700	90	125	33.6	35.5	39.8	520	4.4	117
BXEP-30C-1C5-36B-00-00-0	3000	70	125	33.6	35.5	39.8	709	4.4	160
BXEP-30E-1C5-36B-00-00-0	3000	80	125	33.6	35.5	39.8	630	4.4	142
BXEP-30G-1C5-36B-00-00-0	3000	90	125	33.6	35.5	39.8	535	4.4	121
BXEP-35C-1C5-36B-00-00-0	3500	70	125	33.6	35.5	39.8	726	4.4	164
BXEP-35E-1C5-36B-00-00-0	3500	80	125	33.6	35.5	39.8	650	4.4	146
BXEP-40C-1C5-36B-00-00-0	4000	70	125	33.6	35.5	39.8	736	4.4	166
BXEP-40E-1C5-36B-00-00-0	4000	80	125	33.6	35.5	39.8	670	4.4	151
BXEP-40G-1C5-36B-00-00-0	4000	90	125	33.6	35.5	39.8	575	4.4	130
BXEP-45C-1C5-36B-00-00-0	4500	70	125	33.6	35.5	39.8	736	4.4	166
BXEP-45E-1C5-36B-00-00-0	4500	80	125	33.6	35.5	39.8	670	4.4	151
BXEP-50C-1C5-36B-00-00-0	5000	70	125	33.6	35.5	39.8	736	4.4	166
BXEP-50E-1C5-36B-00-00-0	5000	80	125	33.6	35.5	39.8	670	4.4	151
BXEP-57C-1C5-36B-00-00-0	5700	70	125	33.6	35.5	39.8	731	4.4	165
BXEP-57E-1C5-36B-00-00-0	5700	80	125	33.6	35.5	39.8	670	4.4	151
BXEP-65C-1C5-36B-00-00-0	6500	70	125	33.6	35.5	39.8	720	4.4	162
BXEP-65E-1C5-36B-00-00-0	6500	80	125	33.6	35.5	39.8	668	4.4	151

Notes for Table 1:

- The last 7 characters (including hyphens '-') refer to flux bins, forward voltage bins, and color bin options, respectively. "00-00-0" denotes the full distribution of flux, forward voltage, and 7 SDCM color.
Example: BXEP-30E-1C5-36B-00-00-0 refers to the full distribution of flux, forward voltage, and color within a 3000K 7-step ANSI standard chromaticity region with a minimum of 80CRI, 1x12 die configuration, 4.4w power, 35.5V typical forward voltage.
- Product CCT is hot targeted at $T_{sp} = 85^\circ\text{C}$. Nominal CCT as defined by ANSI C78.377-2011.
- Listed CRIs are minimum values and include test tolerance.
- Products tested under pulsed condition (10ms pulse width) at nominal drive current where $T_j = T_{sp} = 25^\circ\text{C}$.
- Bridgelux maintains a $\pm 7.5\%$ tolerance on luminous flux measurements, $\pm 0.1\text{V}$ tolerance on forward voltage measurements, and ± 2 tolerance on CRI measurements for the SMD 5050 Gen2.
- Refer to Table 6 and Table 7 for Bridgelux SMD 5050 Gen2 Luminous Flux Binning and Forward Voltage Binning information.

Product Selection Guide

The following product configurations are available:

Table 2: Selection Guide, Stabilized DC Performance ($T_{sp} = 85^{\circ}\text{C}$)^{6,7}

Part Number ^{1,5}	Nominal CCT ² (K)	CRI ^{3,4}	Nominal Drive Current (mA)	Forward Voltage ⁴ (V)			Typical DC Flux (lm) ⁴	Typical Power (W)	Typical Efficacy (lm/W)
				Min	Typical	Max			
BXEP-27C-1C5-36B-00-00-0	2700	70	125	32.2	34.0	38.2	615	4.3	144
BXEP-27E-1C5-36B-00-00-0	2700	80	125	32.2	34.0	38.2	546	4.3	128
BXEP-27G-1C5-36B-00-00-0	2700	90	125	32.2	34.0	38.2	462	4.3	109
BXEP-30C-1C5-36B-00-00-0	3000	70	125	32.2	34.0	38.2	630	4.3	148
BXEP-30E-1C5-36B-00-00-0	3000	80	125	32.2	34.0	38.2	559	4.3	131
BXEP-30G-1C5-36B-00-00-0	3000	90	125	32.2	34.0	38.2	475	4.3	112
BXEP-35C-1C5-36B-00-00-0	3500	70	125	32.2	34.0	38.2	645	4.3	152
BXEP-35E-1C5-36B-00-00-0	3500	80	125	32.2	34.0	38.2	577	4.3	136
BXEP-40C-1C5-36B-00-00-0	4000	70	125	32.2	34.0	38.2	654	4.3	154
BXEP-40E-1C5-36B-00-00-0	4000	80	125	32.2	34.0	38.2	595	4.3	140
BXEP-40G-1C5-36B-00-00-0	4000	90	125	32.2	34.0	38.2	511	4.3	120
BXEP-45C-1C5-36B-00-00-0	4500	70	125	32.2	34.0	38.2	654	4.3	154
BXEP-45E-1C5-36B-00-00-0	4500	80	125	32.2	34.0	38.2	595	4.3	140
BXEP-50C-1C5-36B-00-00-0	5000	70	125	32.2	34.0	38.2	654	4.3	154
BXEP-50E-1C5-36B-00-00-0	5000	80	125	32.2	34.0	38.2	595	4.3	140
BXEP-57C-1C5-36B-00-00-0	5700	70	125	32.2	34.0	38.2	649	4.3	153
BXEP-57E-1C5-36B-00-00-0	5700	80	125	32.2	34.0	38.2	595	4.3	140
BXEP-65C-1C5-36B-00-00-0	6500	70	125	32.2	34.0	38.2	639	4.3	150
BXEP-65E-1C5-36B-00-00-0	6500	80	125	32.2	34.0	38.2	593	4.3	139

Notes for Table 2:

- The last 7 characters (including hyphens '-') refer to flux bins, forward voltage bins, and color bin options, respectively. "00-00-0" denotes the full distribution of flux, forward voltage, and 7 SDCM color.
Example: BXEP-30E-1C5-36B-00-00-0 refers to the full distribution of flux, forward voltage, and color within a 3000K 7-step ANSI standard chromaticity region with a minimum of 80CRI, 1x12 die configuration, 4.4w power, 35.5V typical forward voltage.
- Product CCT is hot targeted at $T_{sp} = 85^{\circ}\text{C}$. Nominal CCT as defined by ANSI C78.377-2011.
- Listed CRIs are minimum values and include test tolerance.
- Bridgelux maintains a $\pm 7.5\%$ tolerance on luminous flux measurements, $\pm 0.1\text{V}$ tolerance on forward voltage measurements, and ± 2 tolerance on CRI measurements for the SMD 5050 Gen2.
- Refer to Table 6 and Table 7 for Bridgelux SMD 5050 Gen2 Luminous Flux Binning and Forward Voltage Binning information.
- Typical stabilized DC performance values are provided as reference only and are not a guarantee of performance.
- Typical performance is estimated based on operation under DC (direct current) with LED emitter mounted onto a heat sink with thermal interface material and the solder point temperature maintained at 85°C . Based on Bridgelux test setup, values may vary depending on the thermal design of the luminaire and/or the exposed environment to which the product is subjected.

Performance at Commonly Used Drive Currents

SMD 5050 LEDs are tested to the specifications shown using the nominal drive currents in Table 1. SMD 5050 may also be driven at other drive currents dependent on specific application design requirements. The performance at any drive current can be derived from the current vs. voltage characteristics shown in Figure 2 and the relative luminous flux vs. current characteristics shown in Figure 3. The performance at commonly used drive currents is summarized in Table 3.

Table 3: Performance at Commonly Used Drive Currents

Part Number	CRI	Drive Current ¹ (mA)	Typical V_f $T_{sp} = 25^\circ\text{C}$ (V)	Typical Power $T_{sp} = 25^\circ\text{C}$ (W)	Typical Pulsed Flux ² $T_{sp} = 25^\circ\text{C}$ (lm)	Typical DC Flux ³ $T_{sp} = 85^\circ\text{C}$ (lm)	Typical Efficacy $T_{sp} = 25^\circ\text{C}$ (lm/W)
BXEP-27C-1C5-36B-00-00-0	70	31	32.6	1.0	185	171	183
		63	33.7	2.1	367	335	173
		94	34.6	3.3	534	480	164
		125	35.5	4.4	692	615	156
		160	36.4	5.8	860	753	148
		240	38.4	9.2	1202	1019	131
BXEP-27E-1C5-36B-00-00-0	80	31	32.6	1.0	164	152	163
		63	33.7	2.1	326	298	154
		94	34.6	3.3	474	427	146
		125	35.5	4.4	615	546	139
		160	36.4	5.8	764	669	131
		240	38.4	9.2	1068	906	116
BXEP-27G-1C5-36B-00-00-0	90	31	32.6	1.0	139	128	138
		63	33.7	2.1	276	252	130
		94	34.6	3.3	401	361	123
		125	35.5	4.4	520	462	117
		160	36.4	5.8	646	565	111
		240	38.4	9.2	903	766	98
BXEP-30C-1C5-36B-00-00-0	70	31	32.6	1.0	190	175	188
		63	33.7	2.1	376	343	177
		94	34.6	3.3	547	492	168
		125	35.5	4.4	709	630	160
		160	36.4	5.8	881	771	151
		240	38.4	9.2	1231	1044	134
BXEP-30E-1C5-36B-00-00-0	80	31	32.6	1.0	169	156	167
		63	33.7	2.1	334	305	157
		94	34.6	3.3	486	437	149
		125	35.5	4.4	630	559	142
		160	36.4	5.8	783	685	134
		240	38.4	9.2	1094	928	119

Notes for Table 3:

1. Alternate drive currents in Table 3 are provided for reference only and are not a guarantee of performance.
2. Bridgelux maintains a $\pm 7.5\%$ tolerance on flux measurements.
3. Typical stabilized DC performance values are provided as reference only and are not a guarantee of performance.

Performance at Commonly Used Drive Currents

SMD 5050 LEDs are tested to the specifications shown using the nominal drive currents in Table 1. SMD 5050 may also be driven at other drive currents dependent on specific application design requirements. The performance at any drive current can be derived from the current vs. voltage characteristics shown in Figure 2 and the relative luminous flux vs. current characteristics shown in Figure 3. The performance at commonly used drive currents is summarized in Table 3.

Table 3: Performance at Commonly Used Drive Currents

Part Number	CRI	Drive Current ¹ (mA)	Typical V_f $T_{sp} = 25^\circ\text{C}$ (V)	Typical Power $T_{sp} = 25^\circ\text{C}$ (W)	Typical Pulsed Flux ² $T_{sp} = 25^\circ\text{C}$ (lm)	Typical DC Flux ³ $T_{sp} = 85^\circ\text{C}$ (lm)	Typical Efficacy $T_{sp} = 25^\circ\text{C}$ (lm/W)
BXEP-30G-1C5-36B-00-00-0	90	31	32.6	1.0	143	132	142
		63	33.7	2.1	284	259	134
		94	34.6	3.3	412	371	127
		125	35.5	4.4	535	475	121
		160	36.4	5.8	665	582	114
		240	38.4	9.2	929	788	101
BXEP-35C-1C5-36B-00-00-0	70	31	32.6	1.0	194	179	192
		63	33.7	2.1	385	351	181
		94	34.6	3.3	560	504	172
		125	35.5	4.4	726	645	164
		160	36.4	5.8	902	789	155
		240	38.4	9.2	1261	1069	137
BXEP-35E-1C5-36B-00-00-0	80	31	32.6	1.0	174	160	172
		63	33.7	2.1	345	315	162
		94	34.6	3.3	501	451	154
		125	35.5	4.4	650	577	146
		160	36.4	5.8	808	707	139
		240	38.4	9.2	1129	957	123
BXEP-40C-1C5-36B-00-00-0	70	31	32.6	1.0	197	182	195
		63	33.7	2.1	390	356	184
		94	34.6	3.3	567	511	174
		125	35.5	4.4	736	654	166
		160	36.4	5.8	915	800	157
		240	38.4	9.2	1278	1084	139
BXEP-40E-1C5-36B-00-00-0	80	31	32.6	1.0	179	165	177
		63	33.7	2.1	355	324	167
		94	34.6	3.3	517	465	159
		125	35.5	4.4	670	595	151
		160	36.4	5.8	833	729	143
		240	38.4	9.2	1164	987	126

Notes for Table 3:

1. Alternate drive currents in Table 3 are provided for reference only and are not a guarantee of performance.
2. Bridgelux maintains a $\pm 7.5\%$ tolerance on flux measurements.
3. Typical stabilized DC performance values are provided as reference only and are not a guarantee of performance.

Performance at Commonly Used Drive Currents

Table 3: Performance at Commonly Used Drive Currents(Continued)

Part Number	CRI	Drive Current ¹ (mA)	Typical V_f $T_{sp} = 25^\circ\text{C}$ (V)	Typical Power $T_{sp} = 25^\circ\text{C}$ (W)	Typical Pulsed Flux ² $T_{sp} = 25^\circ\text{C}$ (lm)	Typical DC Flux ³ $T_{sp} = 85^\circ\text{C}$ (lm)	Typical Efficacy $T_{sp} = 25^\circ\text{C}$ (lm/W)
BXEP-40G-1C5-36B-00-00-0	90	31	32.6	1.0	154	142	152
		63	33.7	2.1	305	278	144
		94	34.6	3.3	443	399	136
		125	35.5	4.4	575	511	130
		160	36.4	5.8	715	625	123
		240	38.4	9.2	999	847	108
BXEP-45C-1C5-36B-00-00-0	70	31	32.6	1.0	197	182	195
		63	33.7	2.1	390	356	184
		94	34.6	3.3	567	511	174
		125	35.5	4.4	736	654	166
		160	36.4	5.8	915	800	157
		240	38.4	9.2	1278	1084	139
BXEP-45E-1C5-36B-00-00-0	80	31	32.6	1.0	179	165	177
		63	33.7	2.1	355	324	167
		94	34.6	3.3	517	465	159
		125	35.5	4.4	670	595	151
		160	36.4	5.8	833	729	143
		240	38.4	9.2	1164	987	126
BXEP-50C-1C5-36B-00-00-0	70	31	32.6	1.0	197	182	195
		63	33.7	2.1	390	356	184
		94	34.6	3.3	567	511	174
		125	35.5	4.4	736	654	166
		160	36.4	5.8	915	800	157
		240	38.4	9.2	1278	1084	139
BXEP-50E-1C5-36B-00-00-0	80	31	32.6	1.0	179	165	177
		63	33.7	2.1	355	324	167
		94	34.6	3.3	517	465	159
		125	35.5	4.4	670	595	151
		160	36.4	5.8	833	729	143
		240	38.4	9.2	1164	987	126

Notes for Table 3:

1. Alternate drive currents in Table 3 are provided for reference only and are not a guarantee of performance.
2. Bridgelux maintains a $\pm 7.5\%$ tolerance on flux measurements.
3. Typical stabilized DC performance values are provided as reference only and are not a guarantee of performance.

Performance at Commonly Used Drive Currents

Table 3: Performance at Commonly Used Drive Currents (Continued)

Part Number	CRI	Drive Current ¹ (mA)	Typical V _f T _{sp} = 25 °C (V)	Typical Power T _{sp} = 25 °C (W)	Typical Pulsed Flux ² T _{sp} = 25 °C (lm)	Typical DC Flux ³ T _{sp} = 85 °C (lm)	Typical Efficacy T _{sp} = 25 °C (lm/W)
BXEP-57C-1C5-36B-00-00-0	70	31	32.6	1.0	196	180	194
		63	33.7	2.1	388	354	183
		94	34.6	3.3	564	507	173
		125	35.5	4.4	731	649	165
		160	36.4	5.8	908	795	156
		240	38.4	9.2	1269	1077	138
BXEP-57E-1C5-36B-00-00-0	80	31	32.6	1.0	179	165	177
		63	33.7	2.1	355	324	167
		94	34.6	3.3	517	465	159
		125	35.5	4.4	670	595	151
		160	36.4	5.8	833	729	143
		240	38.4	9.2	1164	987	126
BXEP-65C-1C5-36B-00-00-0	70	31	32.6	1.0	193	178	191
		63	33.7	2.1	382	349	180
		94	34.6	3.3	555	500	171
		125	35.5	4.4	720	639	162
		160	36.4	5.8	895	783	153
		240	38.4	9.2	1250	1060	136
BXEP-65E-1C5-36B-00-00-0	80	31	32.6	1.0	179	165	177
		63	33.7	2.1	354	323	167
		94	34.6	3.3	515	464	158
		125	35.5	4.4	668	593	151
		160	36.4	5.8	830	726	143
		240	38.4	9.2	1160	984	126

Notes for Table 3:

1. Alternate drive currents in Table 3 are provided for reference only and are not a guarantee of performance.
2. Bridgelux maintains a ± 7.5% tolerance on flux measurements.
3. Typical stabilized DC performance values are provided as reference only and are not a guarantee of performance.

Electrical Characteristics

Table 4: Electrical Characteristics

Part Number ¹	Drive Current (mA)	Forward Voltage (V) ^{2,3}			Typical Temperature Coefficient of Forward Voltage $\Delta V_f / \Delta T$ (mV/°C)	Typical Thermal Resistance Junction to Solder Point ⁴ R_{j-sp} (°C/W)
		Minimum	Typical	Maximum		
BXEP-XXX-1C5-36B-00-00-0	125	33.6	35.5	39.8	-16.7	1.9

Notes for Table 4:

- The last 7 characters (including hyphens '-') refer to flux bins, forward voltage bins, and color bin options, respectively. "00-00-0" denotes the full distribution of flux, forward voltage, and 7 SDCM color.
Example: BXEP-30E-1C5-36B-00-00-0 refers to the full distribution of flux, forward voltage, and color within a 3000K 7-step ANSI standard chromaticity region with a minimum of 80CRI, 1x12 die configuration, 4.4w power, 35.5V typical forward voltage.
- Bridgelux maintains a tolerance of $\pm 0.1V$ on forward voltage measurements. Voltage minimum and maximum values at the nominal drive current are guaranteed by 100% test.
- Products tested under pulsed condition (10ms pulse width) at nominal drive current where $T_{sp} = 25^\circ C$.
- Thermal resistance value was calculated using total electrical input power; optical power was not subtracted from input power.

Absolute Maximum Ratings

Table 5: Maximum Ratings

Parameter	Maximum Rating
LED Junction Temperature (T_j)	125°C
Storage Temperature	-40°C to +105°C
Operating Solder Point Temperature (T_{sp})	-40°C to +105°C
Soldering Temperature	260°C or lower for a maximum of 10 seconds
Maximum Drive Current ¹	240mA
Maximum Peak Pulsed Forward Current ²	300mA
Maximum Reverse Voltage	Bridgelux LEDs are not designed to be driven in reverse bias
Moisture Sensitivity Rating	MSL 3
Electrostatic Discharge	2kV HBM. JEDEC-JS-001-HBM and JEDEC-JS-001-2012

Notes for Table 5:

1. The condition of the maximum drive current is limited, Figure 7 can be reference.
2. Bridgelux recommends a maximum duty cycle of 10% and pulse width of 10 ms when operating LED SMD at maximum peak pulsed current specified. Maximum peak pulsed current indicate values where LED SMD can be driven without catastrophic failures.
3. The maximum drive current for LM80 test result is based on 128% nominal drive current listed.

Product Bin Definitions

Table 6 lists the standard photometric luminous flux bins for Bridgelux SMD 5050 LEDs. Although several bins are listed, product availability in a particular bin varies by production run and by product performance. Not all bins are available in all CCTs.

Table 6: Luminous Flux Bin Definitions at 125mA, $T_{sp}=25^{\circ}\text{C}$

Bin Code	Minimum	Maximum	Unit	Condition
A7	470	505	lm	$I_F=125\text{mA}$
A8	505	545		
A9	545	590		
B1	590	635		
B2	635	685		
B3	685	740		
B4	740	800		
B5	800	865		

Note for Table 6:

1. Bridgelux maintains a tolerance of $\pm 7.5\%$ on luminous flux measurements.

Table 7: Forward Voltage Bin Definition at 125mA, $T_{sp}=25^{\circ}\text{C}$

Bin Code	Minimum	Maximum	Unit	Condition
MD	33.5	35	V	$I_F=125\text{mA}$
ME	35	36.5		
MF	36.5	38		
MG	38	39.5		
MH	39.5	41		

Note for Table 7:

1. Bridgelux maintains a tolerance of $\pm 0.1\text{V}$ on forward voltage measurements.

Product Bin Definitions

Table 8: 3- and 5-step MacAdam Ellipse Color Bin Definitions

CCT	Color Space	Center Point		Major Axis	Minor Axis	Ellipse Rotation Angle	Color Bin
		X	Y				
2700K	3 SDCM	0.4578	0.4101	0.00810	0.00420	53.70	3
	5 SDCM	0.4578	0.4101	0.01350	0.00700	53.70	5
3000K	3 SDCM	0.4338	0.4030	0.00834	0.00408	53.22	3
	5 SDCM	0.4338	0.4030	0.01390	0.00680	53.22	5
3500K	3 SDCM	0.4103	0.3961	0.00927	0.00414	54.00	3
	5 SDCM	0.4103	0.3961	0.01545	0.00690	54.00	5
4000K	3 SDCM	0.3818	0.3797	0.00939	0.00402	53.72	3
	5 SDCM	0.3818	0.3797	0.01565	0.00670	53.72	5
4500K	3 SDCM	0.3611	0.3658	0.00756	0.00338	57.58	3
	5 SDCM	0.3611	0.3658	0.01260	0.00563	57.58	5
5000K	3 SDCM	0.3447	0.3553	0.00822	0.00354	59.62	3
	5 SDCM	0.3447	0.3553	0.01370	0.00590	59.62	5
5700K	3 SDCM	0.3287	0.3417	0.00746	0.00320	59.09	3
	5 SDCM	0.3287	0.3417	0.01243	0.00533	59.09	5
6500K	3 SDCM	0.3123	0.3282	0.00669	0.00285	58.57	3
	5 SDCM	0.3123	0.3282	0.01115	0.00475	58.57	5

Notes for Table 8:

1. Color binning at $T_{sp}=85^{\circ}\text{C}$
2. Bridgelux maintains a tolerance of ± 0.007 on x and y color coordinates in the CIE 1931 color space.

Product Bin Definitions

Figure 1: C.I.E. 1931 Chromaticity Diagram (3 Color Bin Structure, hot-color targeted at $T_{sp}=85^{\circ}\text{C}$)

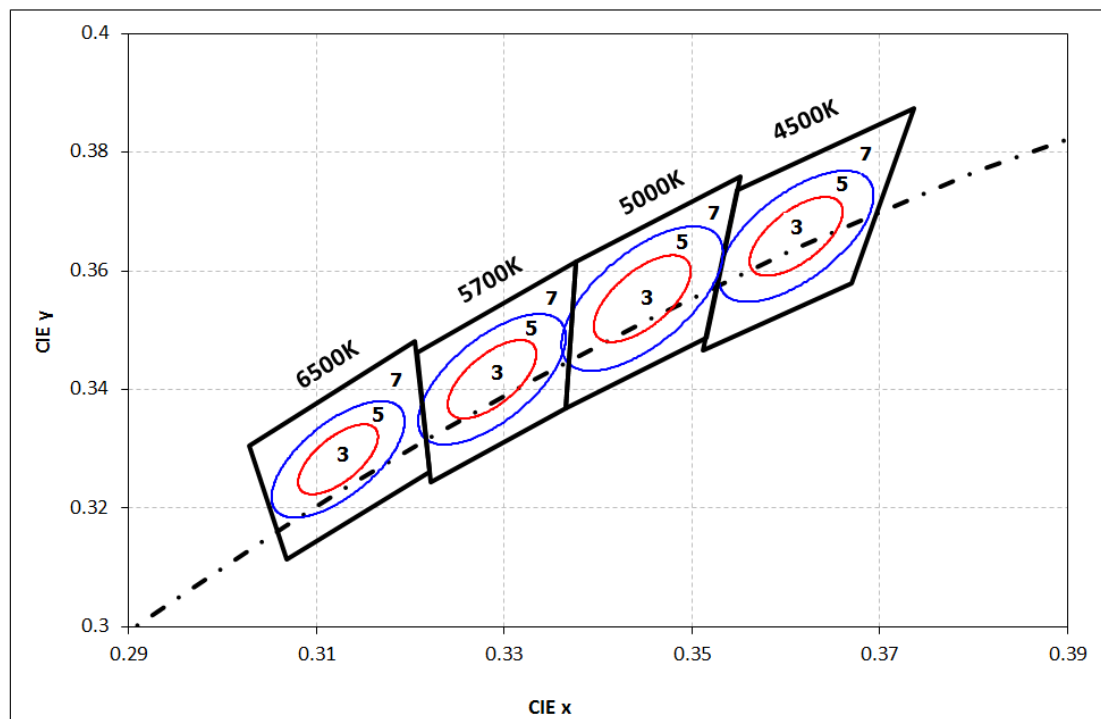
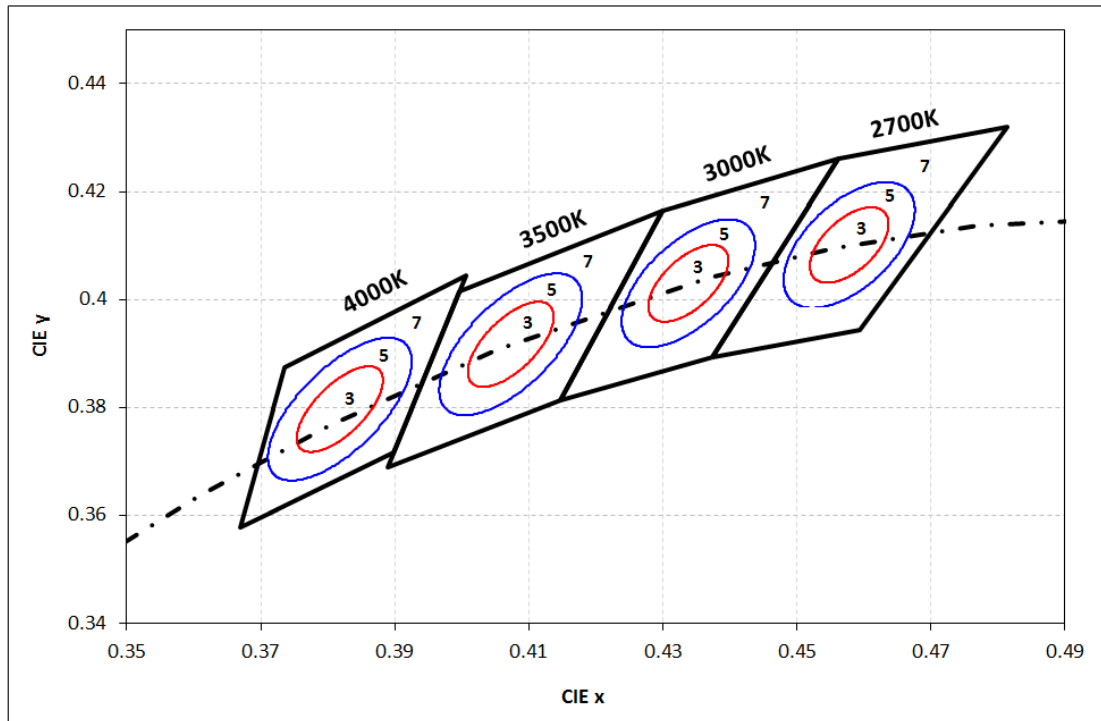

Performance Curves

Figure 2: Drive Current vs. Voltage ($T_{sp}=25^{\circ}\text{C}$)

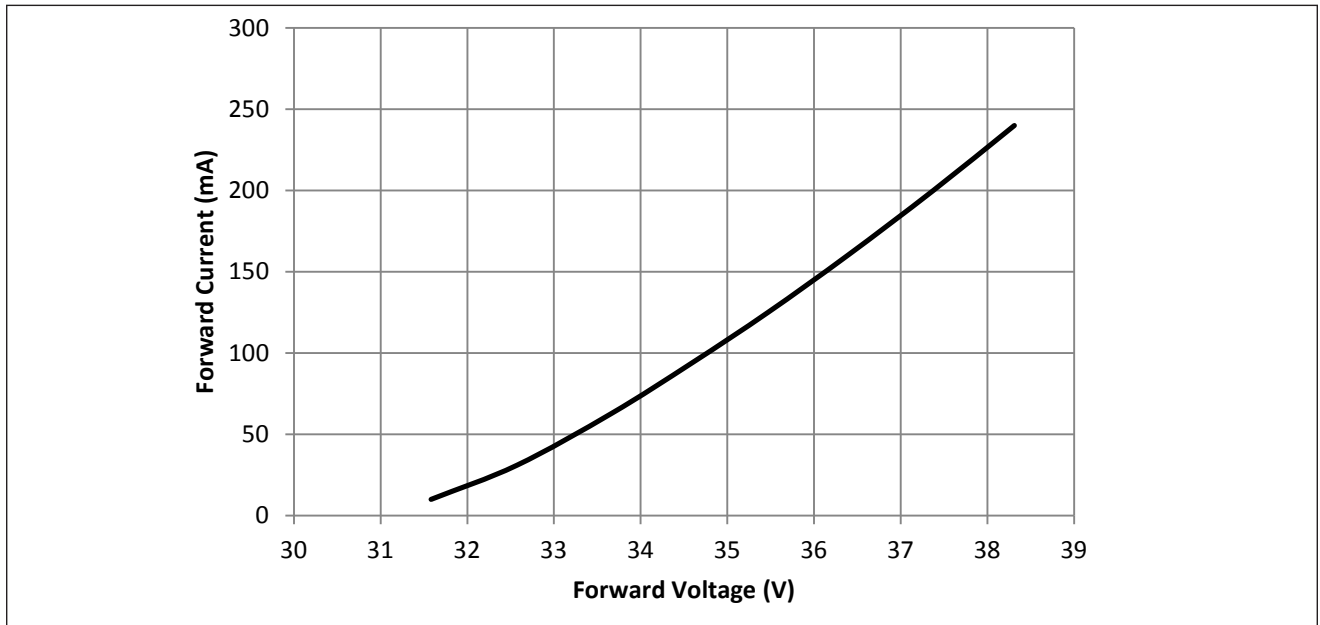
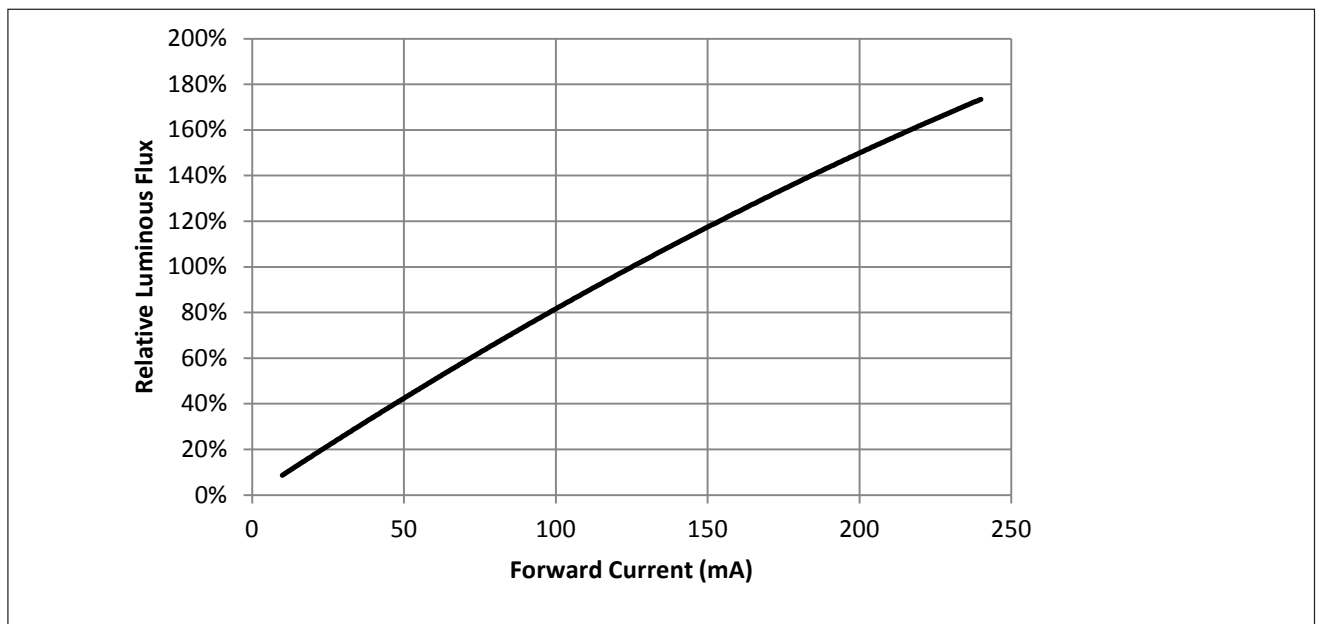

Figure 3: Typical Relative Luminous Flux vs. Drive Current ($T_{sp}=25^{\circ}\text{C}$)



Note for Figure 3:

1. Bridgelux does not recommend driving high power LEDs at low currents. Doing so may produce unpredictable results. Pulse width modulation (PWM) is recommended for dimming effects.

Performance Curves

Figure 4: Typical Relative DC Flux vs. Solder Point Temperature

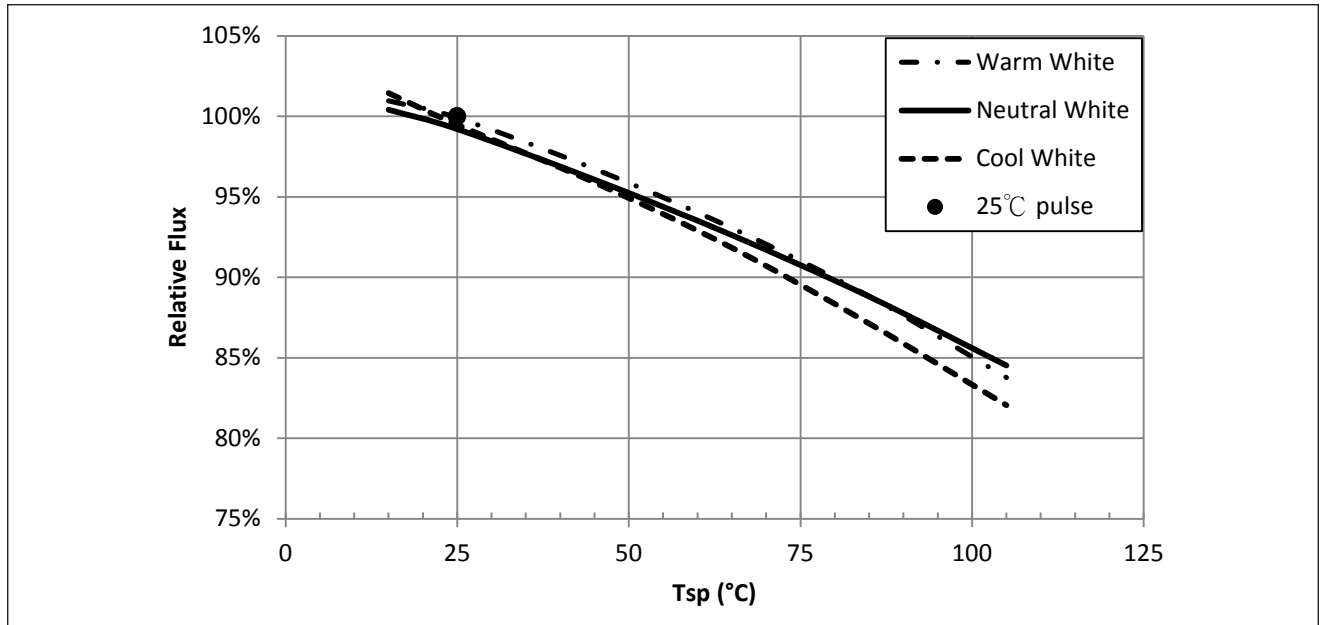
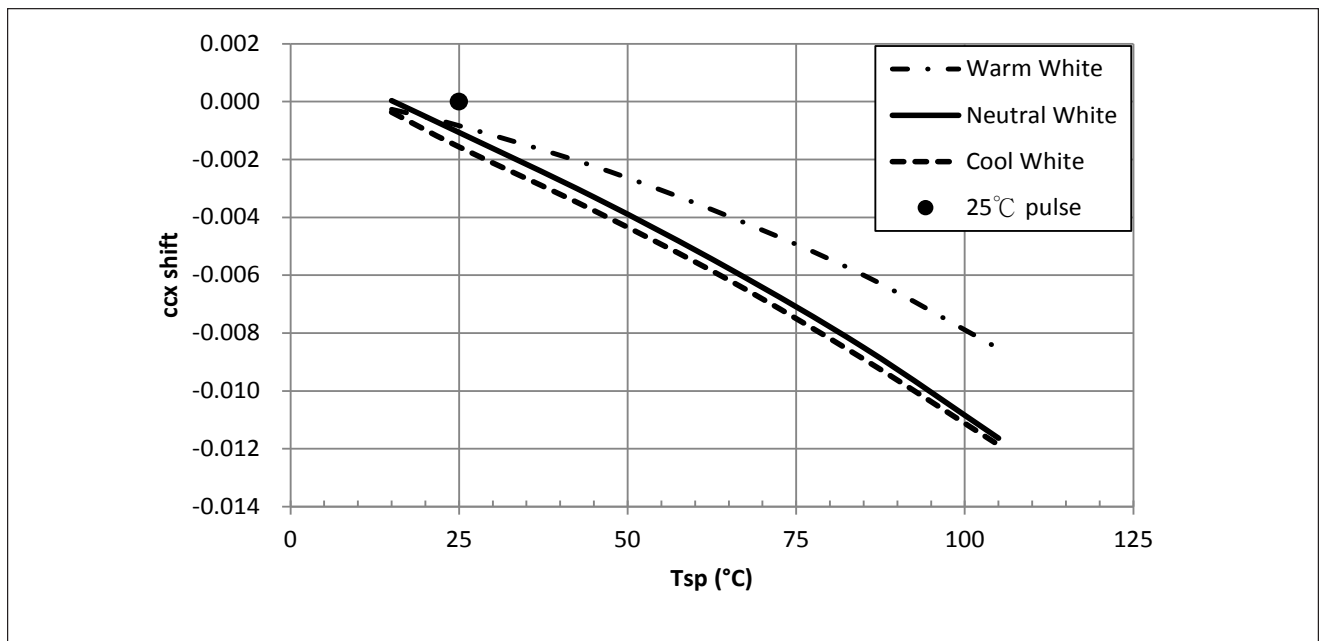

Figure 5: Typical DC cxx Shift vs. Solder Point Temperature



Notes for Figures 4 & 5:

1. Characteristics shown for warm white based on 2700K and 80 CRI.
2. Characteristics shown for neutral white based on 4000K and 80 CRI.
3. Characteristics shown for cool white based on 5700K and 80 CRI.
4. For other color SKUs, the shift in color will vary. Please contact your Bridgelux Sales Representative for more information.

Performance Curves

Figure 6: Typical DC ccy Shift vs. Solder Point Temperature

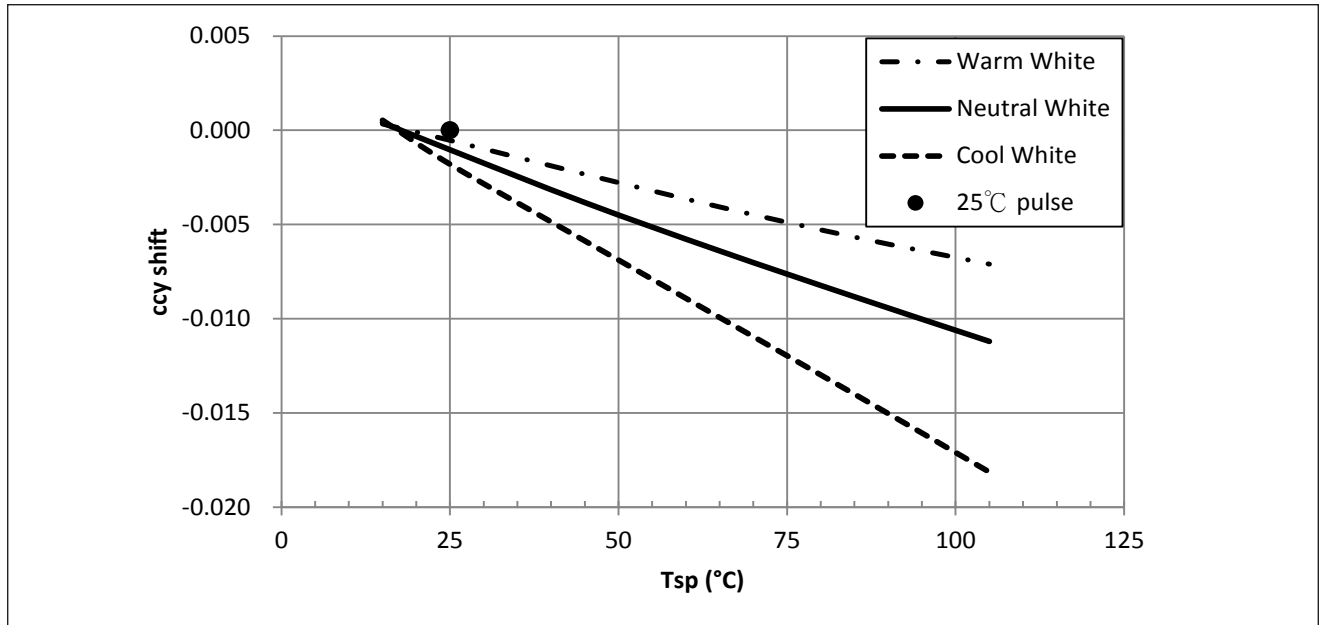

Notes for Figure 6:

1. Characteristics shown for warm white based on 2700K and 80 CRI.
2. Characteristics shown for neutral white based on 4000K and 80 CRI.
3. Characteristics shown for cool white based on 5700K and 80 CRI.
4. For other color SKUs, the shift in color will vary. Please contact your Bridgelux Sales Representative for more information.

Figure 7: Drive Current Derating Curve

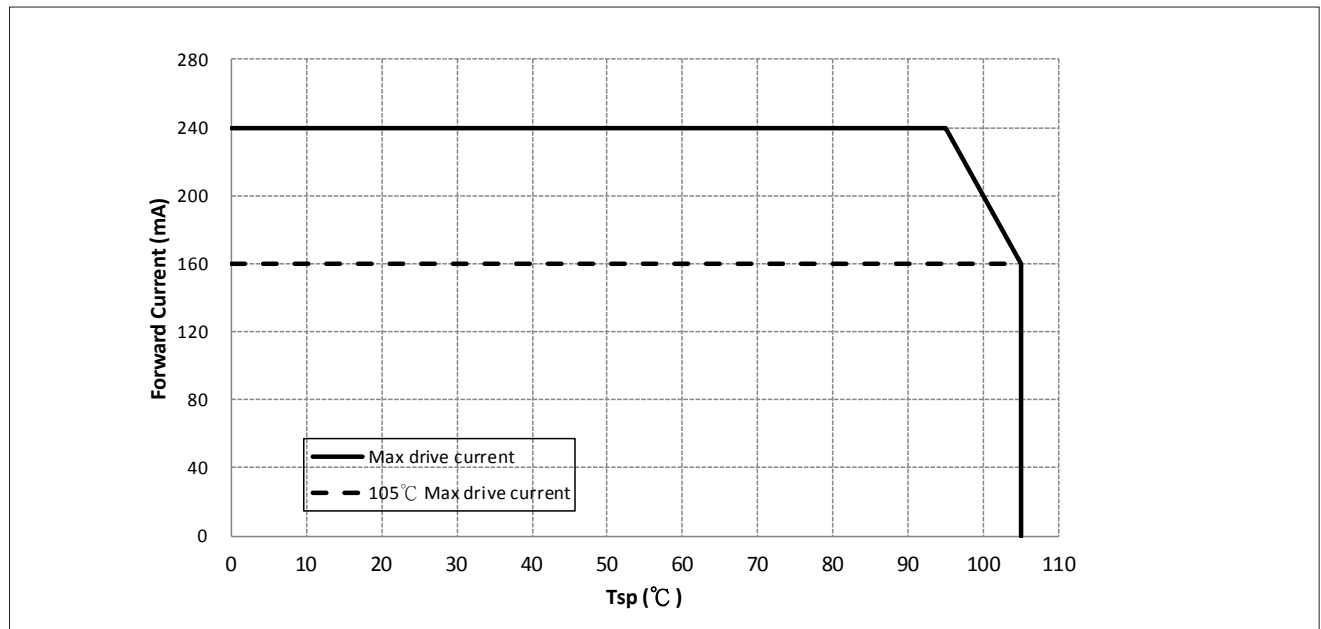

Typical Radiation Pattern

Figure 8: Typical Spatial Radiation Pattern at 125mA, $T_{sp}=25^{\circ}\text{C}$

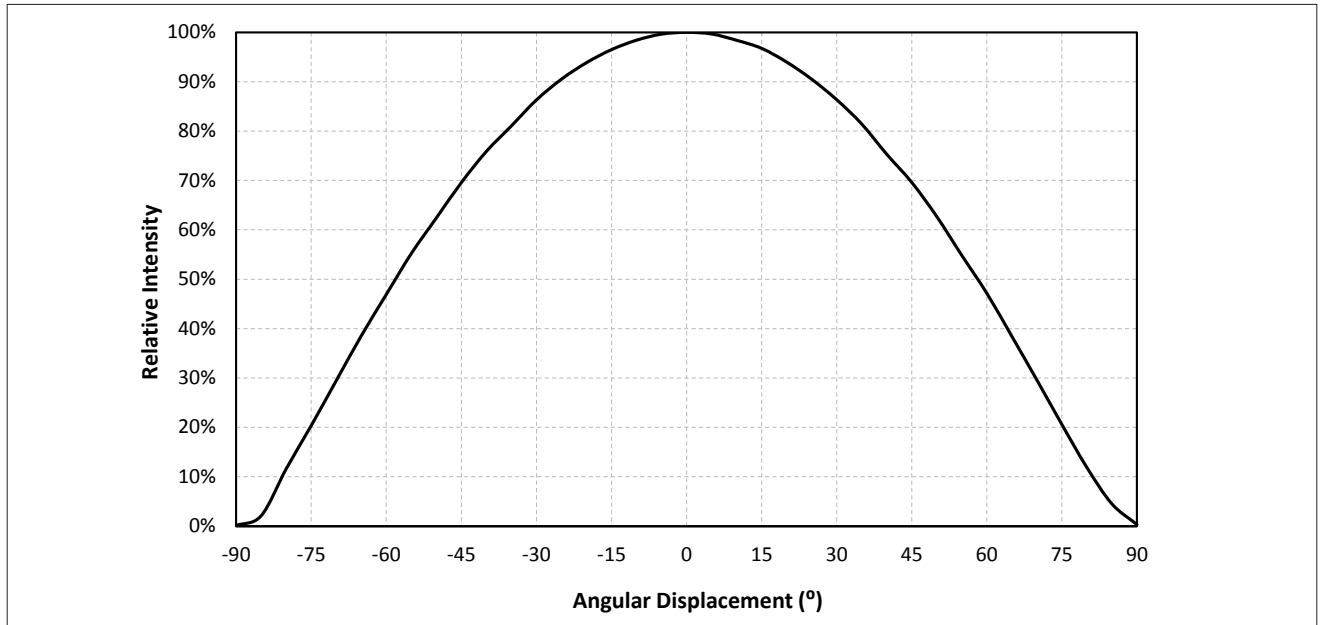

Notes for Figure 8:

1. Typical viewing angle is 116° .
2. The viewing angle is defined as the off axis angle from the centerline where luminous intensity (lv) is $\frac{1}{2}$ of the peak value.

Figure 9: Typical Polar Radiation Pattern at 125mA, $T_{sp}=25^{\circ}\text{C}$

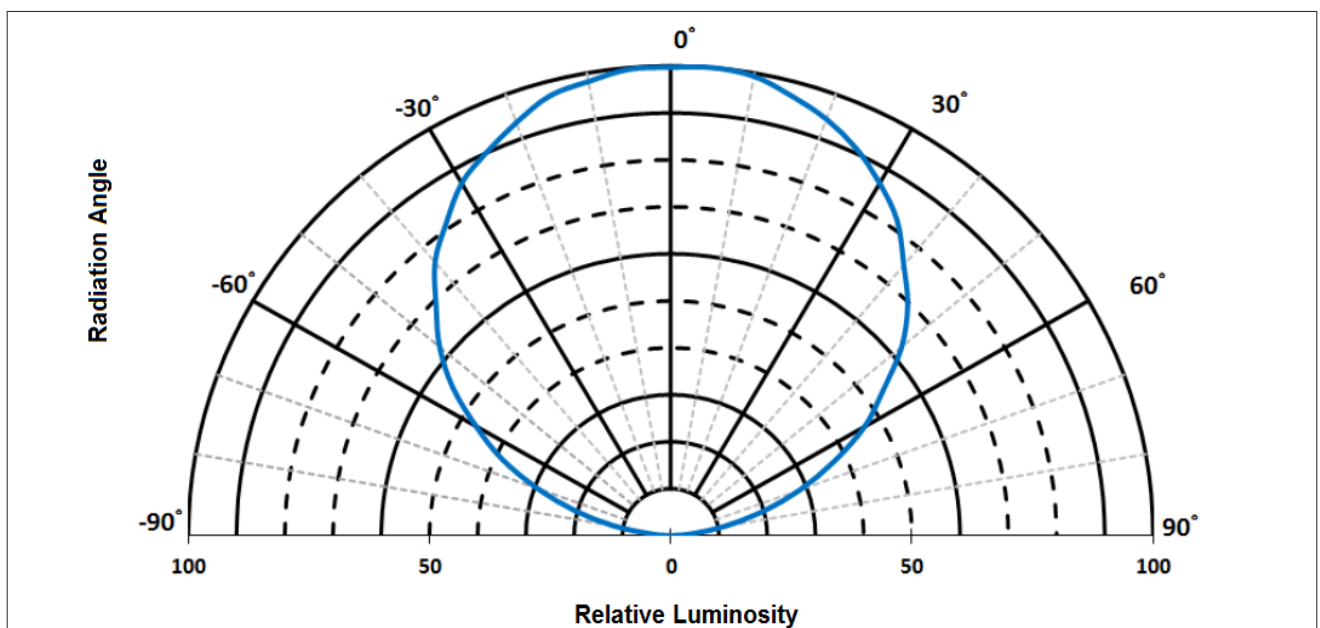

Typical Color Spectrum

Figure 10: Typical Color Spectrum

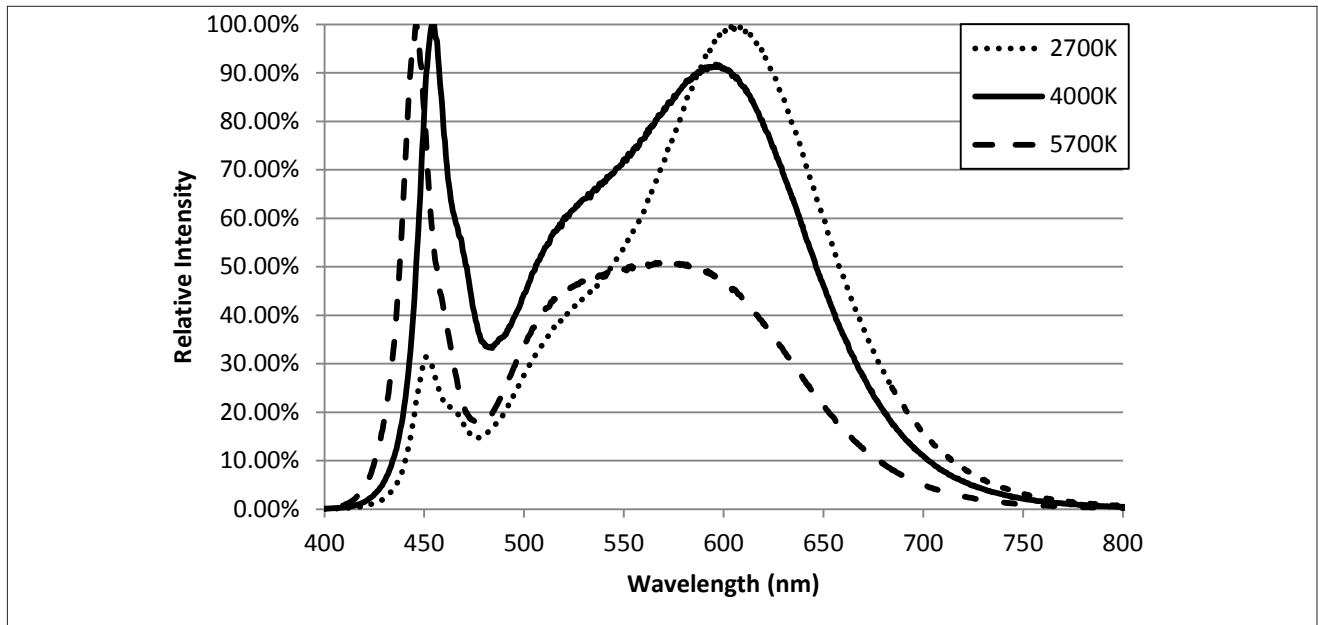

Notes for Figure 10:

1. Color spectra measured at nominal current for $T_{sp} = 25^{\circ}\text{C}$
2. Color spectra shown for warm white is 2700K and 80 CRI.
3. Color spectra shown for neutral white is 4000K and 80 CRI.
4. Color spectra shown for cool white is 5700K and 80 CRI.

Mechanical Dimensions

Figure 11: Drawing for SMD 5050

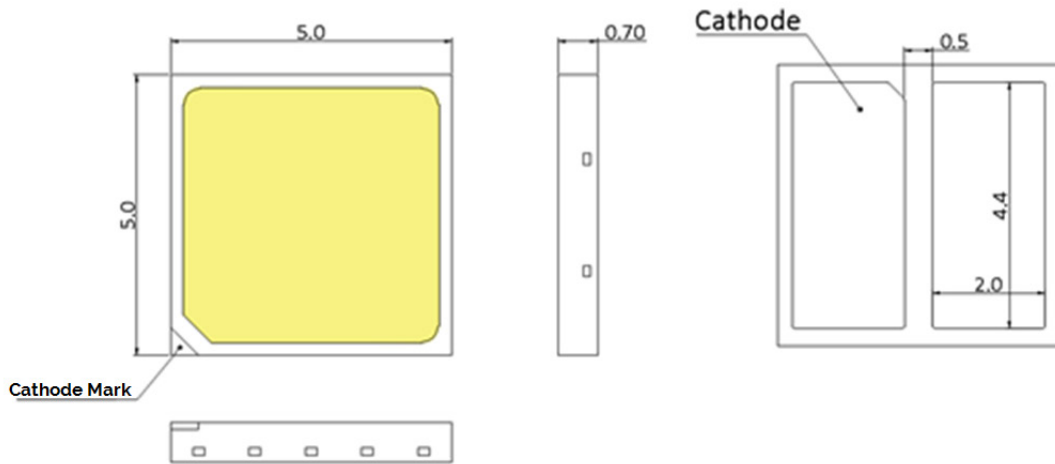

Notes for Figure 11:

1. Drawings are not to scale.
2. Drawing dimensions are in millimeters.
3. Unless otherwise specified, tolerances are $\pm 0.10\text{mm}$.

Recommended PCB Soldering Pad Pattern

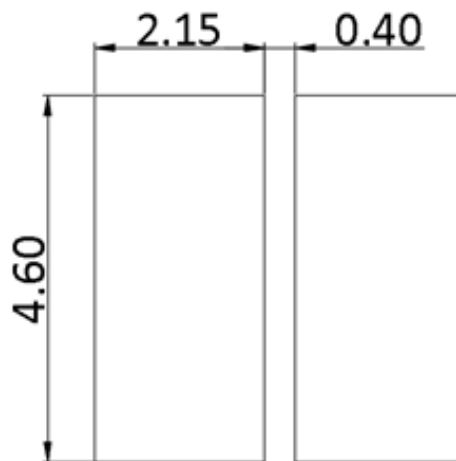

Reliability

Table 9: Reliability Test Items and Conditions

No .	Items	Reference Standard	Test Conditions	Drive Current	Test Duration	Units Failed/Tested
1	Moisture/Reflow Sensitivity	J-STD-020E	$T_{sld} = 260^{\circ}\text{C}$, 10sec, Precondition: 60°C , 60%RH, 168hr	-	3 reflows	0/22
2	Low Temperature Storage	JESD22-A119	$T_a = -40^{\circ}\text{C}$	-	1000 hours	0/22
3	High Temperature Storage	JESD22-A103D	$T_a = 105^{\circ}\text{C}$	-	1000 hours	0/22
4	Low Temperature Operating Life	JESD22-A108D	$T_a = -40^{\circ}\text{C}$	125mA	1000 hours	0/22
5	Temperature Humidity Operating Life	JESD22-A101C	$T_{sp} = 85^{\circ}\text{C}$, RH=85%	125mA	1000 hours	0/22
6	High Temperature Operating Life	JESD22-A108D	$T_{sp} = 105^{\circ}\text{C}$	160mA	1000 hours	0/22
7	Power switching	IEC62717:2014	$T_{sp} = 105^{\circ}\text{C}$ 30 sec on, 30 sec off	160mA	30000 cycles	0/22
8	Thermal Shock	JESD22-A106B	$T_a = -40^{\circ}\text{C} \sim 100^{\circ}\text{C}$; Dwell : 15min; Transfer: 10sec	-	200 cycles	0/22
9	Temperature Cycle	JESD22-A104E	$T_a = -40^{\circ}\text{C} \sim 100^{\circ}\text{C}$; Dwell at extreme temperature: 15min; Ramp rate < $105^{\circ}\text{C}/\text{min}$	-	200 cycles	0/22
10	Electrostatic Discharge	JS-001-2012	HBM, 2kV, 15k Ω , 100pF, Alternately positive or negative	-	-	0/22

Passing Criteria

Item	Symbol	Test Condition	Passing Criteria
Forward Voltage	Vf	125mA	$\Delta V_f < 10\%$
Luminous Flux	Fv	125mA	$\Delta F_v < 30\%$
Chromaticity Coordinates	(x, y)	125mA	$\Delta u'v' < 0.007$

Notes for Table 9:

- Measurements are performed after allowing the LEDs to return to room temperature
- T_{sld} : reflow soldering temperature; T_a : ambient temperature

Reflowing Characteristics

Figure 12 : Reflow Profile

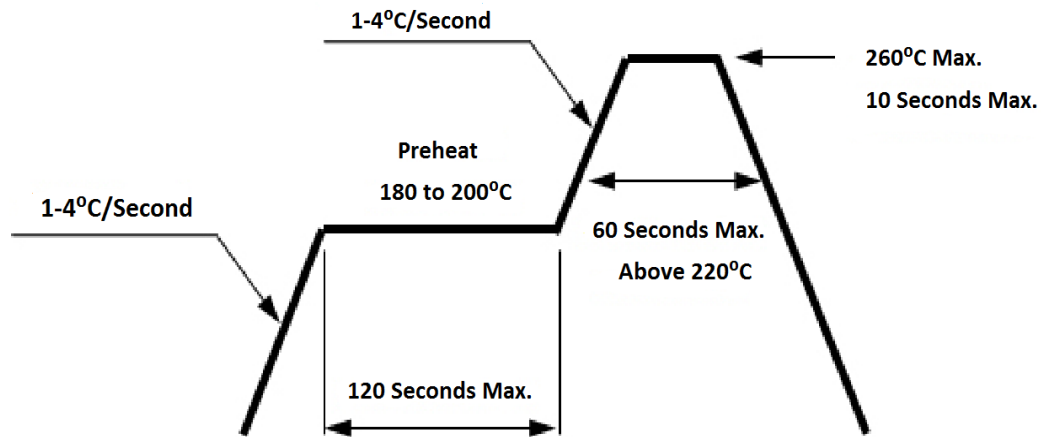

Profile Feature	Lead Free Assembly
Preheat: Temperature Range	180°C – 200°C
Preheat: Time (Maximum)	120 seconds
Peak Temperature	260°C
Soldering Time (Maximum)	10 seconds
Allowable Reflow Cycles	2

Figure 13 : Pick and Place

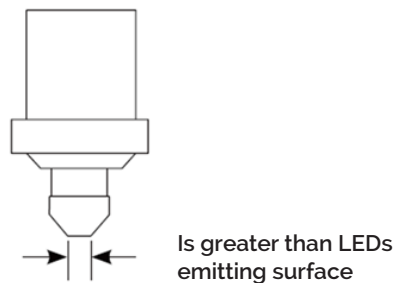

Note for Figure 13:

- When using a pick and place machine, choose a nozzle that has a larger diameter than the LED's emitting surface. Using a Pick-and-Place nozzle with a smaller diameter than the size of the LEDs emitting surface will cause damage and may also cause the LED to not illuminate.

Packaging

Figure 14: Emitter Reel Drawings

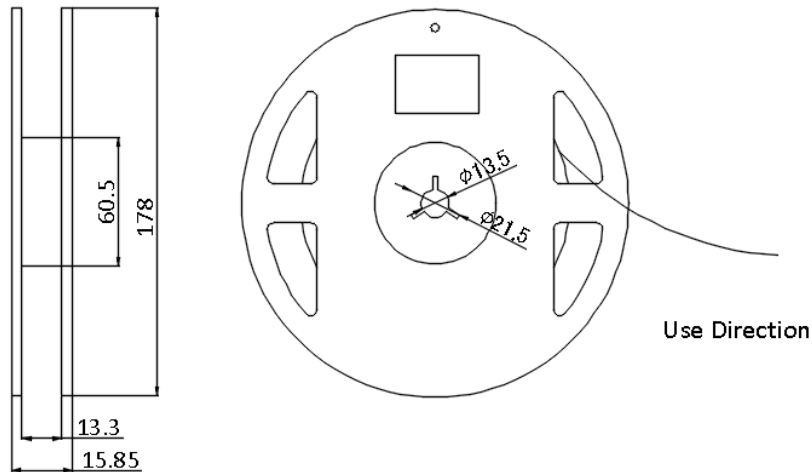

Note for Figure 14:

1. Drawings are not to scale. Drawing dimensions are in millimeters.

Figure 15: Emitter Tape Drawings

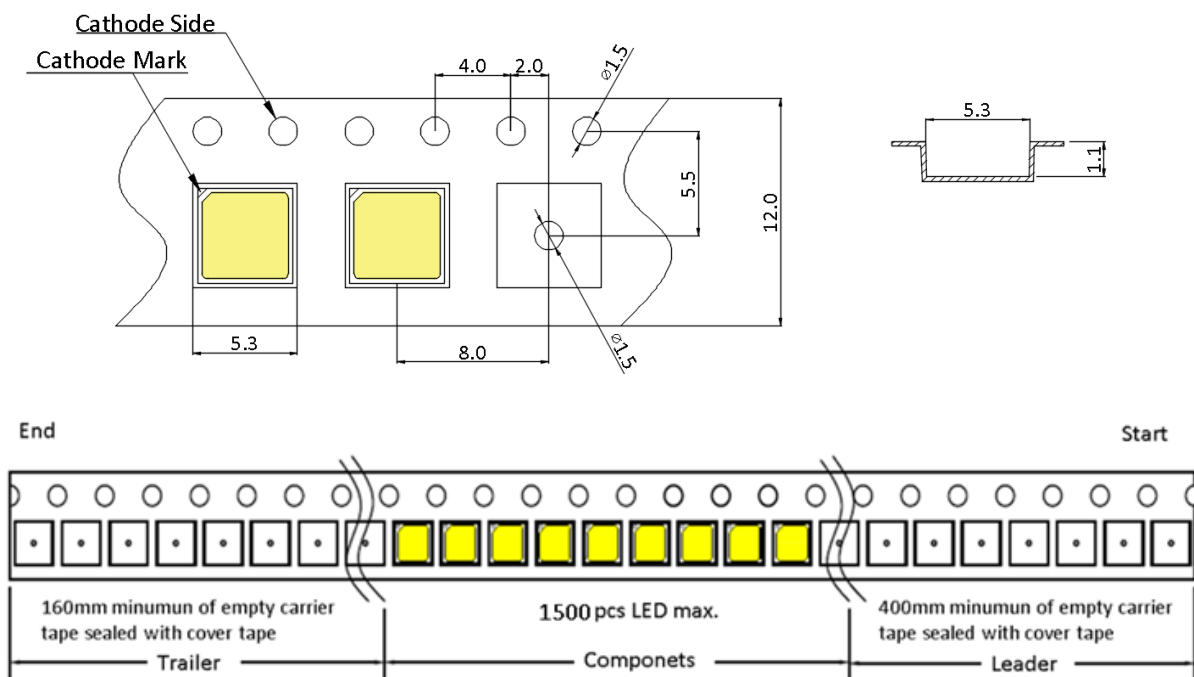

Note for Figure 15:

1. Drawings are not to scale. Drawing dimensions are in millimeters.

Packaging

Figure 16: Emitter Reel Packaging Drawings

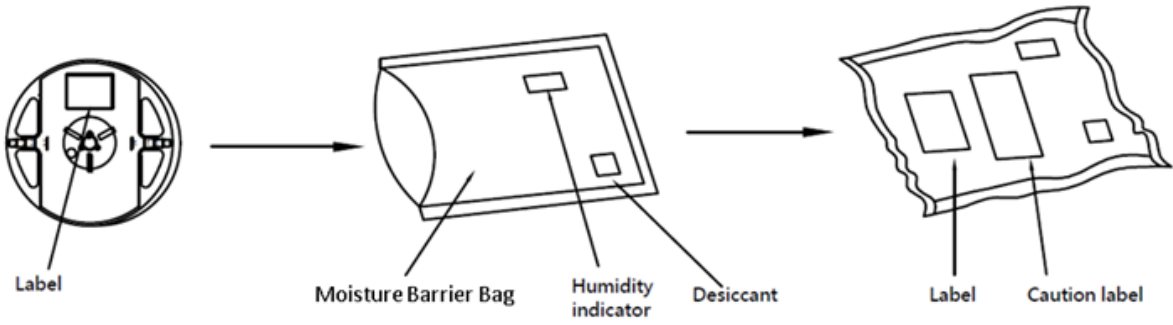

Note for Figure 16:
1. Drawings are not to scale.

Design Resources

Please contact your Bridgelux sales representative for assistance.

Precautions

CAUTION: CHEMICAL EXPOSURE HAZARD

Exposure to some chemicals commonly used in luminaire manufacturing and assembly can cause damage to the LED emitter. Please consult Bridgelux Application Note AN51 for additional information.

CAUTION: EYE SAFETY

This SMD package emits visible light, that, under certain circumstances, could be harmful to the eye. Proper safeguards must be used.

CAUTION: RISK OF BURN

Do not touch the SMD LED emitter during operation. Allow the emitter to cool for a sufficient period of time before handling. The SMD LED emitter may reach elevated temperatures such that could burn skin when touched.

CAUTION

CONTACT WITH LIGHT EMITTING SURFACE (LES)

Avoid any contact with the LES. Do not touch the LES of the emitter or apply stress to the LES (yellow phosphor resin area). Contact may cause damage to the emitter

Optics and reflectors must not be mounted in contact with the LES (yellow phosphor resin area).

Disclaimers

MINOR PRODUCT CHANGE POLICY

The rigorous qualification testing on products offered by Bridgelux provides performance assurance. Slight cosmetic changes that do not affect form, fit, or function may occur as Bridgelux continues product optimization.

STANDARD TEST CONDITIONS

Unless otherwise stated, LED emitter testing is performed at the nominal drive current.

About Bridgelux: We Build Light That Transforms

At Bridgelux, we help companies, industries and people experience the power and possibility of light. Since 2002, we've designed LED solutions that are high performing, energy efficient, cost effective and easy to integrate. Our focus is on light's impact on human behavior, delivering products that create better environments, experiences and returns—both experiential and financial. And our patented technology drives new platforms for commercial and industrial luminaires.

For more information about the company, please visit
bridgelux.com
twitter.com/Bridgelux
facebook.com/Bridgelux
youtube.com/user/Bridgelux
WeChat ID: BridgeluxInChina



46430 Fremont Boulevard
Fremont, CA 94538
Tel (925) 583-8400
www.bridgelux.com

© 2018 Bridgelux, Inc. All rights reserved 2018. Product specifications are subject to change without notice. Bridgelux and the Bridgelux stylized logo design are registered trademarks of Bridgelux, Inc. All other trademarks are the property of their respective owners.

单击下面可查看定价，库存，交付和生命周期等信息

[>>Bridgelux\(普瑞光电\)](#)