

Bridgelux® Vesta® Series Tunable White Gen 2 13mm Array

Product Data Sheet DS351



Introduction

Vesta® Series

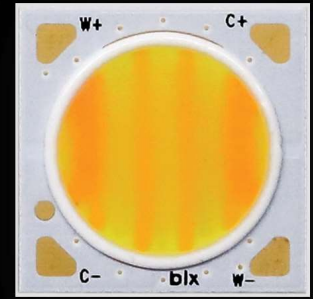

Vesta® Series Tunable White Array products deliver adaptable light in a solid state lighting package. Vesta Series products tap into the powerful mediums of light and color to influence experience, well-being, and human emotion. They allow designers to mimic daylight to increase productivity and well-being, retailers to influence shopper behavior and fixture manufacturers to simulate the familiar glow and dimming of incandescent lamps. This high flux density light source is designed to support a wide range of high quality directional luminaires and replacement lamps for commercial and residential applications.

Lighting system designs incorporating these LED arrays deliver comparable performance to 150 Watt incandescent-based luminaires, while increasing system level efficacy and prolonging service life. Typical luminaire and lamp types appropriate for this family include replacement lamps, down lights, wall packs and accent, spot and track lights.

Features

- Tuning range from 2700K-5000K, 2700K-6500K, 1800-3000K and 1800-4000K
- Flux packages up to 2250lumens typical
- Efficacy of up to 124 lm/W typical
- Uniform, high quality illumination
- Minimum 90 CRI option
- 3 SDCM binning for 2700K, 3000K, 4000K, 5000K and 6500K color points
- More energy efficient than incandescent, halogen and fluorescent lamps
- Industry standardized dimensions

Benefits

- Superior color mixing enabled by phosphor dispensed technology
- Compact system design
- High quality, true color reproduction
- Reliable operation facilitated by high conductivity substrates
- Enhanced optical control
- Uniform, consistent white light



Contents

Product Feature Map	2
Product Nomenclature	2
Product Selection Guide	3
Electrical Characteristics	4
Absolute Maximum Ratings	5
Performance Curves	6-8
Typical Radiation Pattern	9
Typical Color Spectrum	10-11
Mechanical Dimensions	12
Color Binning Information	13
Packaging and Labeling	14
Design Resources	15
Precautions	15
Disclaimers	15
About Bridgelux	16

Product Feature Map

Bridgelux arrays are fully engineered devices that provide consistent thermal and optical performance on an engineered mechanical platform. The arrays incorporate several features to simplify design integration and assembly. Please visit www.bridgelux.com for more information on the Vesta Series family of products.

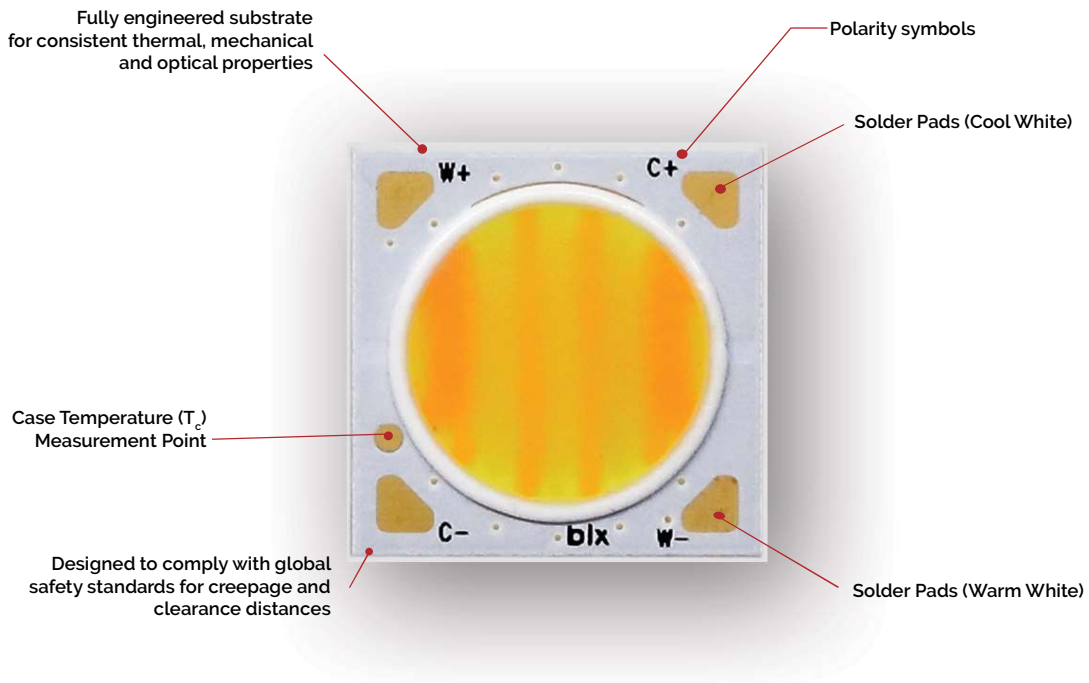

Product Nomenclature

The part number designation for Bridgelux Vesta Series arrays is explained as follows:

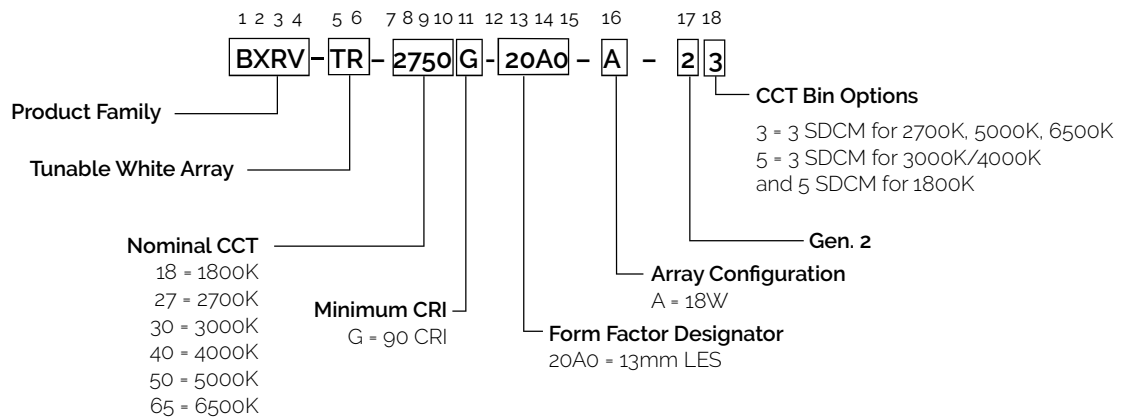

Product Selection Guide

The following product configurations are available:

Table 1: Selection Guide, Measurement Data

Part Number	Nominal CCT ¹ T _c =85°C (K)	Minimum CRI ^{2,3} T _c =85°C	Nominal Drive Current (per channel) (mA)	Typical V _f T _c =25°C ⁵ (V)	Typical Power T _c =25°C (W)	Typical Pulsed Flux ^{3,4,5} T _c =25°C (lm)	Typical Efficacy T _c =25°C (lm/W)	Minimum Pulsed Flux T _c =25°C ⁶ (lm)	Typical DC Flux T _c =85°C ^{6,7} (lm)
BXRV-TR-2750G-20A0-A-23	2700	90	500	35.2	17.6	1980	113	1782	1742
	5000	90	500	36.3	18.2	2300	127	2070	2001
BXRV-TR-2765G-20A0-A-23	2700	90	500	35.2	17.6	1950	111	1755	1716
	6500	90	500	36.3	18.2	2250	124	2025	1958
BXRV-TR-1830G-20A0-A-25	1800	90	500	35.2	17.6	1450	82	1305	1291
	3000	90	500	36.3	18.2	2090	115	1881	1839
BXRV-TR-1840G-20A0-A-25	1800	90	500	35.2	17.6	1350	77	1215	1202
	4000	90	500	36.3	18.2	2200	121	1980	1936

Notes for Table 1:

- Nominal CCT as defined by ANSI C78.377-2011.
- Minimum CRI value is 90. Minimum Rg value for 90 CRI products is 50. Bridgelux maintains a ±3 tolerance on all Rg values.
- Products tested under pulsed condition (10ms pulse width) at nominal test current where T_j (junction temperature) = T_c (case temperature) = 25°C.
- Typical performance values are provided as a reference only and are not a guarantee of performance.
- Bridgelux maintains a ±7% tolerance on flux measurements.
- Typical stabilized DC performance values are provided as reference only and are not a guarantee of performance.
- Typical performance is estimated based on operation under DC (direct current) with LED array mounted onto a heat sink with thermal interface material and the case temperature maintained at 85°C. Based on Bridgelux test setup, values may vary depending on the thermal design of the luminaire and/or the exposed environment to which the product is subjected.
- Minimum flux values at the nominal test current are guaranteed by 100% test.

Electrical Characteristics

Table 2: Electrical Characteristics

Part Number	Nominal CCT ¹ T _c = 85°C (K)	Nominal Drive Current (mA)	Forward Voltage Pulsed, T _c = 25°C (V) ^{1, 2, 3, 7}			Typical Temperature Coefficient of Forward Voltage ⁴ ΔV _f /ΔT _c (mV/°C)	Typical Thermal Resistance Junction to Case ⁵ R _{j-c} (°C/W)	Driver Selection Voltages ⁶ (V)	
			Minimum	Typical	Maximum			V _f Min. Hot T _c = 105°C (V)	V _f Max. Cold T _c = -40°C (V)
BXRV-TR-xxxxG-20A0-A-23	1800, 2700	500	33.2	35.2	37.4	-12.1	0.53	32.1	38.3
	3000, 4000, 5000, 6500K	500	34.1	36.3	38.5	-12.5		33.2	39.5

Notes for Table 2:

1. Parts are tested in pulsed conditions, T_c = 25°C. Pulse width is 10ms.
2. Voltage minimum and maximum are provided for reference only and are not a guarantee of performance.
3. Bridgelux maintains a tester tolerance of ± 0.10V on forward voltage measurements.
4. Typical temperature coefficient of forward voltage tolerance is ± 0.1mV for nominal current.
5. Thermal resistance value was calculated using total electrical input power; optical power was not subtracted from input power. The thermal interface material used during testing is not included in the thermal resistance value.
6. V_f min hot and max cold values are provided as reference only and are not guaranteed by test. These values are provided to aid in driver design and selection over the operating range of the product.
7. This product has been designed and manufactured per IEC 62031:2014. This product has passed dielectric withstand voltage testing at 500 V. The working voltage designated for the insulation is 45V DC. The maximum allowable voltage across the array must be determined in the end product application.

Absolute Maximum Ratings

Table 3: Maximum Ratings

Parameter	Maximum Rating	
LED Junction Temperature (T_j)	125°C	
Storage Temperature	-40°C to +105°C	
Operating Case Temperature ¹ (T_c)	105°C	
Soldering Temperature ²	300°C or lower for a maximum of 6 seconds	
Maximum Total Drive Current ⁴	700mA	
	Channel 1 2700K, 1800K	Channel 2 5000K/6500K 3000K/4000K
Maximum Drive Current Per Channel ^{3,4}	700mA	700mA
Maximum Peak Pulsed Drive Current ⁵	960mA	720mA
Maximum Total Power	26.6W	

Notes for Table 3:

1. For IEC 62717 requirement, please contact Bridgelux Sales Support.
2. See Bridgelux Application Note AN101 for more information.
3. Lumen maintenance and lifetime predictions are valid for drive current and case temperature conditions used for LM-80 testing as included in the applicable LM-80 test report. Contact your Bridgelux sales representatives for the LM-80 report.
4. Maximum Drive Current is maximum combined drive currents between both 2700K and 6500K channels. For example, if 700mA is applied to one channel, no current may be applied to the other channel of the array. If 300mA is applied to one channel, then a maximum of 400mA can be applied to the other channel.
5. Bridgelux recommends a maximum duty cycle of 10% and pulse width of 20ms when operating LED arrays at the maximum peak pulsed current specified. Maximum peak pulsed currents indicate values where the LED array can be driven without catastrophic failures.

Performance Curves

Figure 1: Forward Voltage vs. Forward Current, $T_c=25^\circ\text{C}$

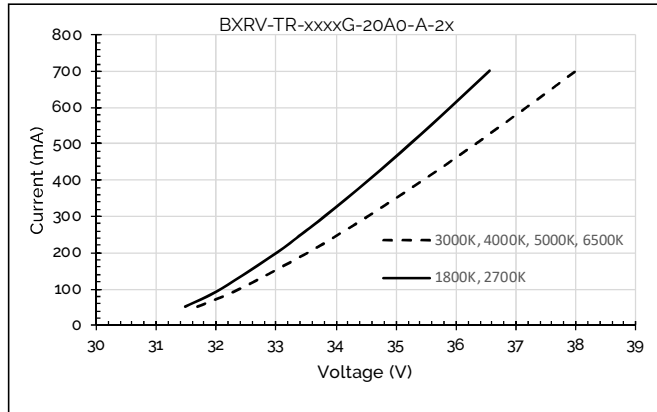

Figure 2: Relative Flux vs. Drive Current, $T_c=25^\circ\text{C}$

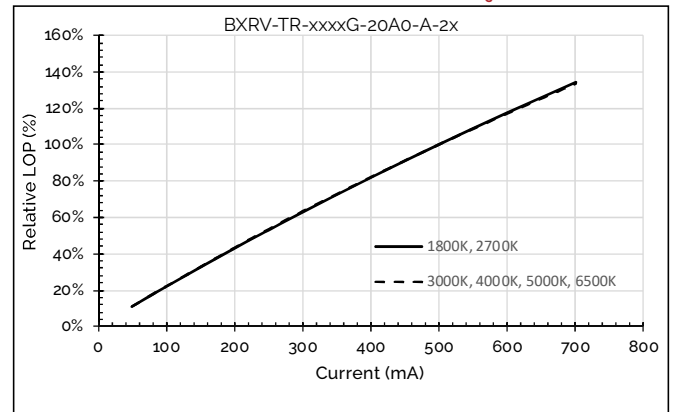

Figure 3: Relative Flux vs. Case Temperature

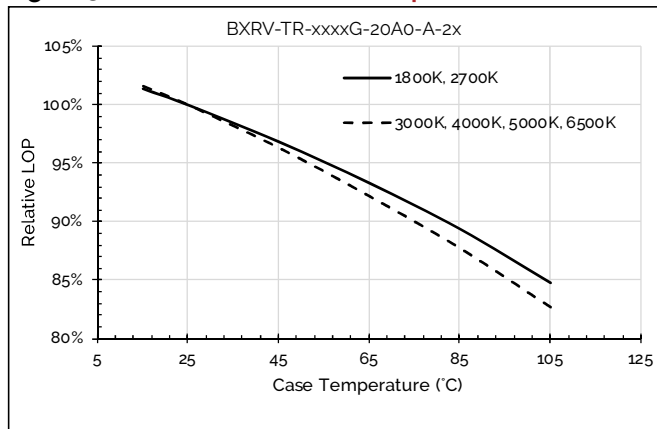

Figure 4: Relative Voltage vs. Case Temperature

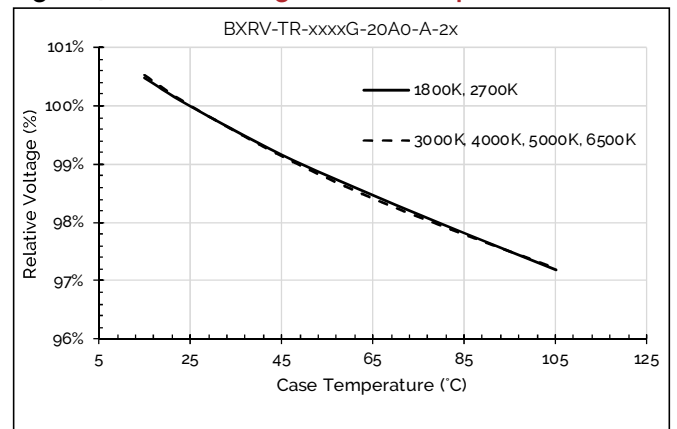

Figure 5: CCT vs. Relative Warm White Current

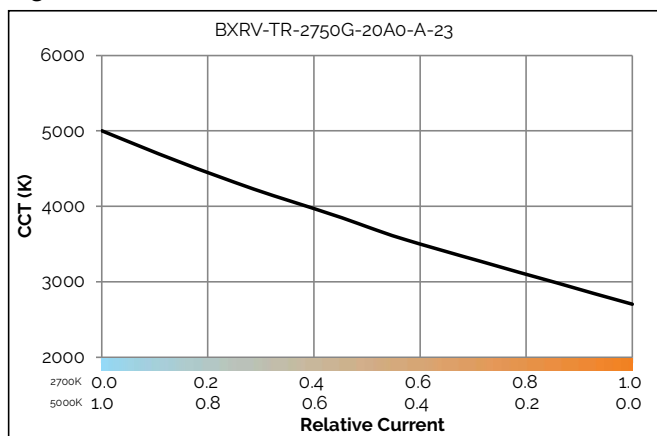
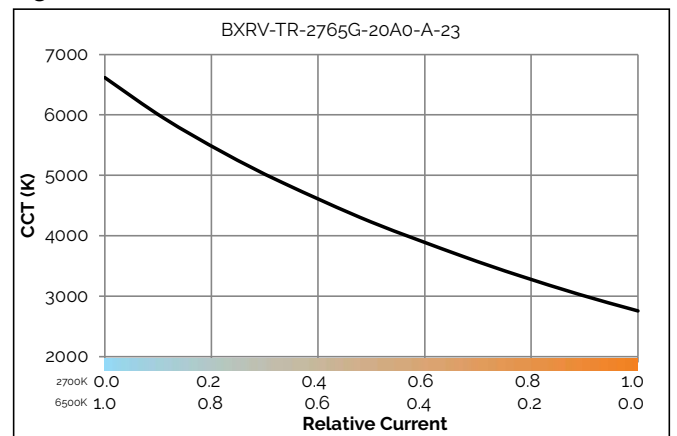

Figure 6: CCT vs. Relative Warm White Current



Performance Curves

Figure 7: CCT vs. Relative Warm White Current

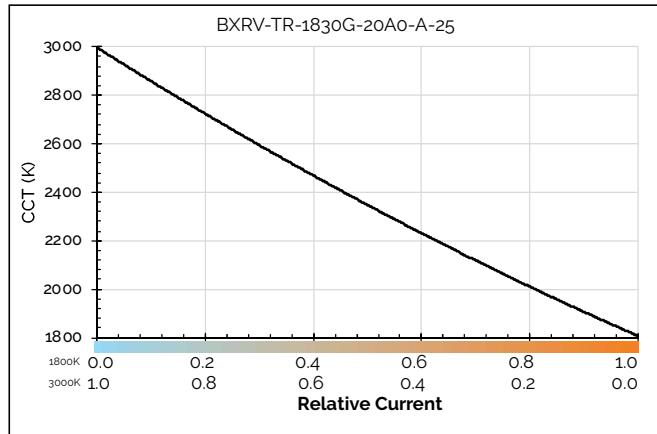

Figure 8: CCT vs. Relative Warm White Current

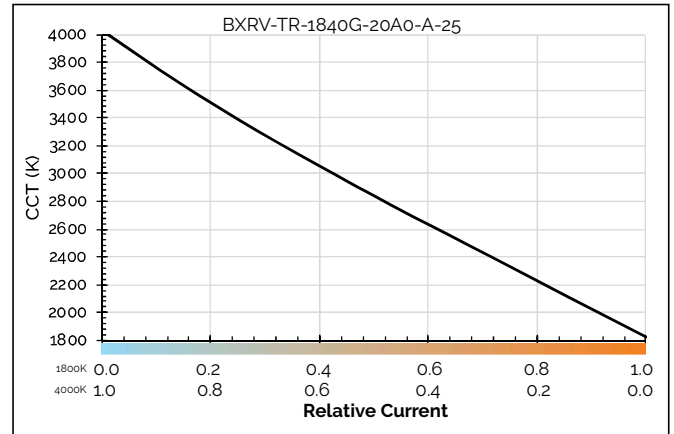

Figure 9: Relative Flux vs. Relative Current

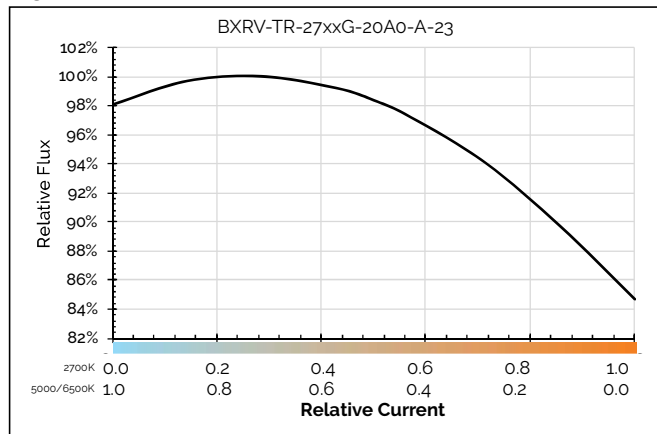

Figure 10: Relative Flux vs. Relative Current

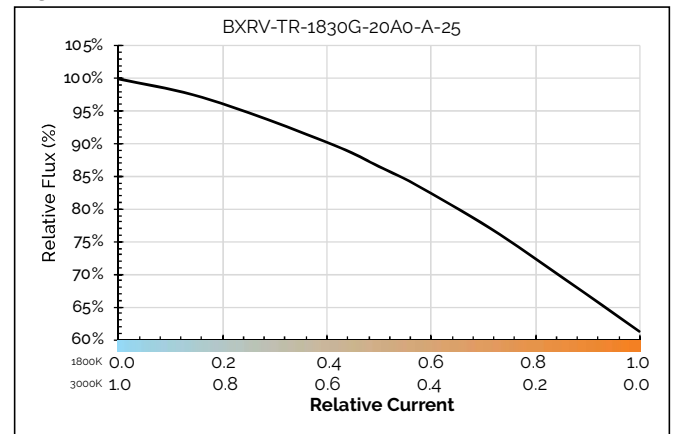
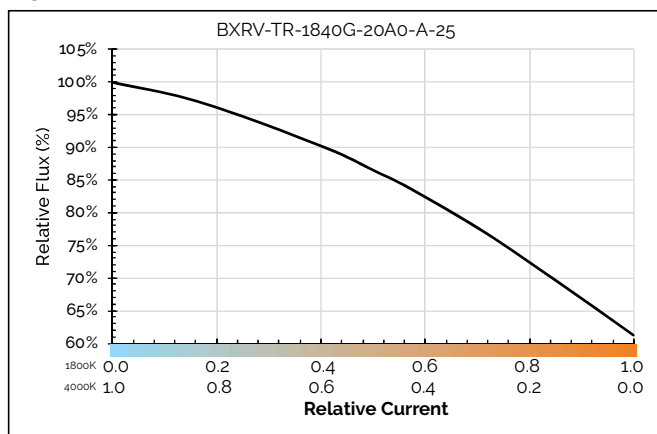

Figure 11: Relative Flux vs. Relative Current



Performance Curves

Figure 12: CCT Tuning Range, Tc=85C

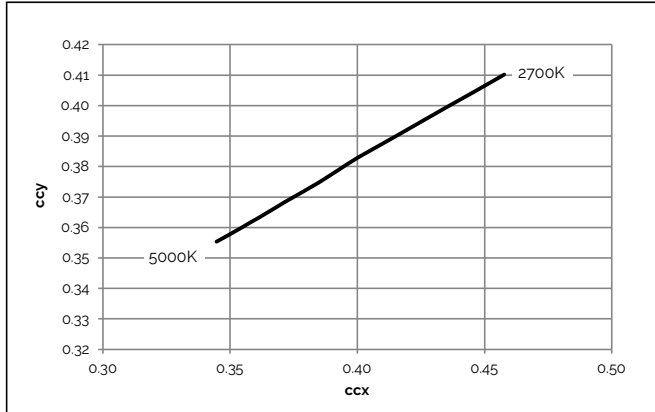

Figure 13: CCT Tuning Range, Tc=85C

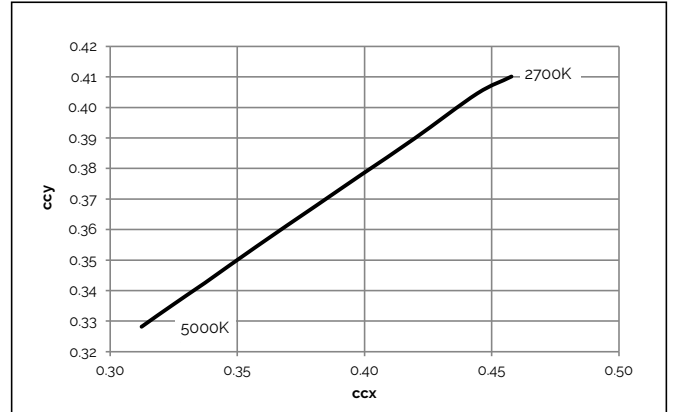

Figure 14: CCT Tuning Range, Tc=85C

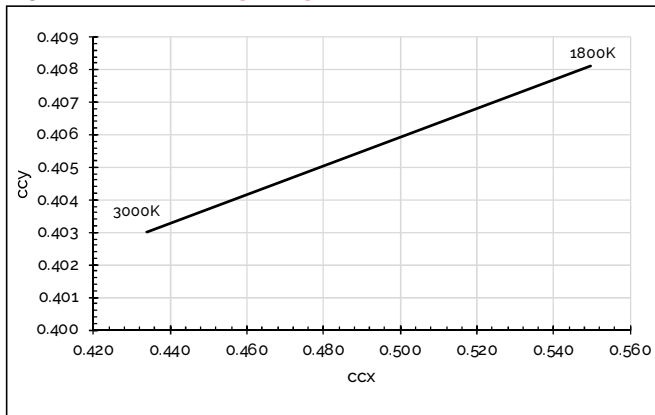
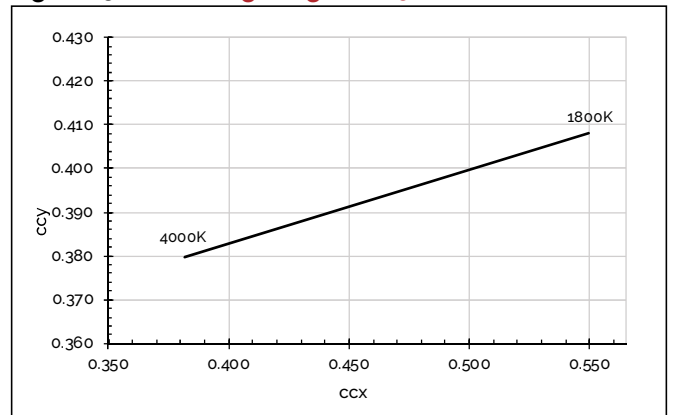
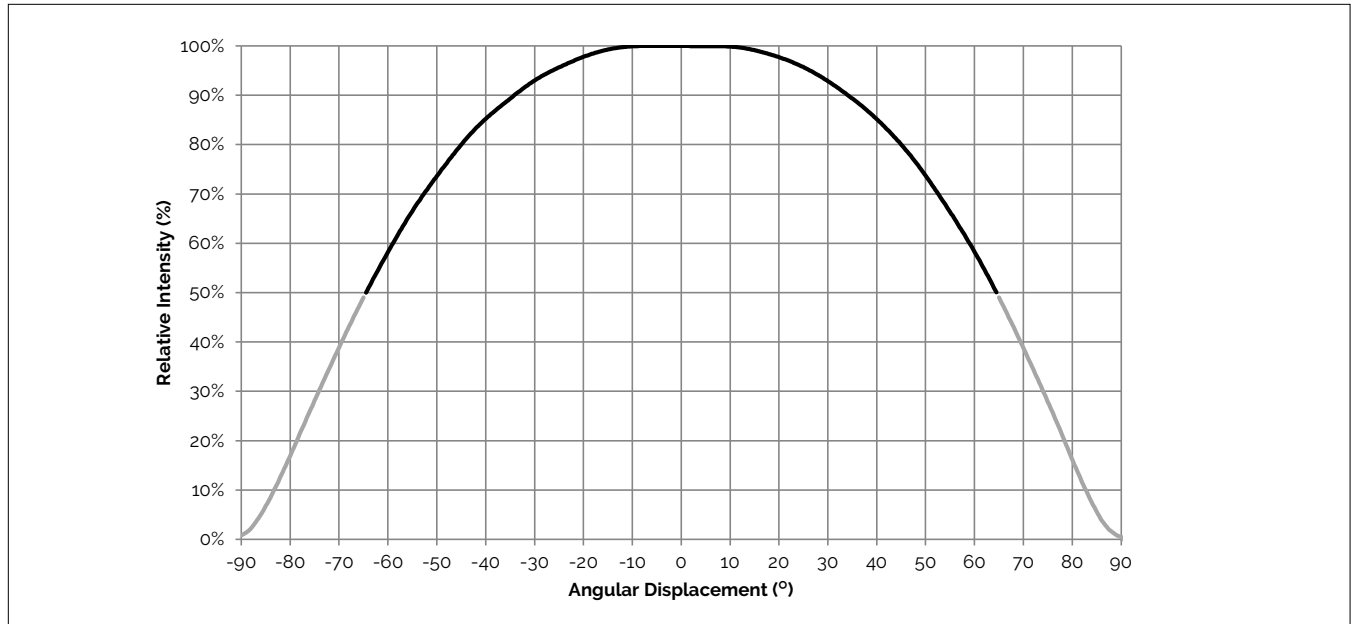

Figure 15: CCT Tuning Range, Tc=85C



Typical Radiation Pattern

Figure 16: Typical Spatial Radiation Pattern



Notes for Figure 16:

1. Typical viewing angle is 130°.
2. The viewing angle is defined as the off axis angle from the centerline where I_v is $\frac{1}{2}$ of the peak value.

Figure 17: Typical Polar Radiation Pattern

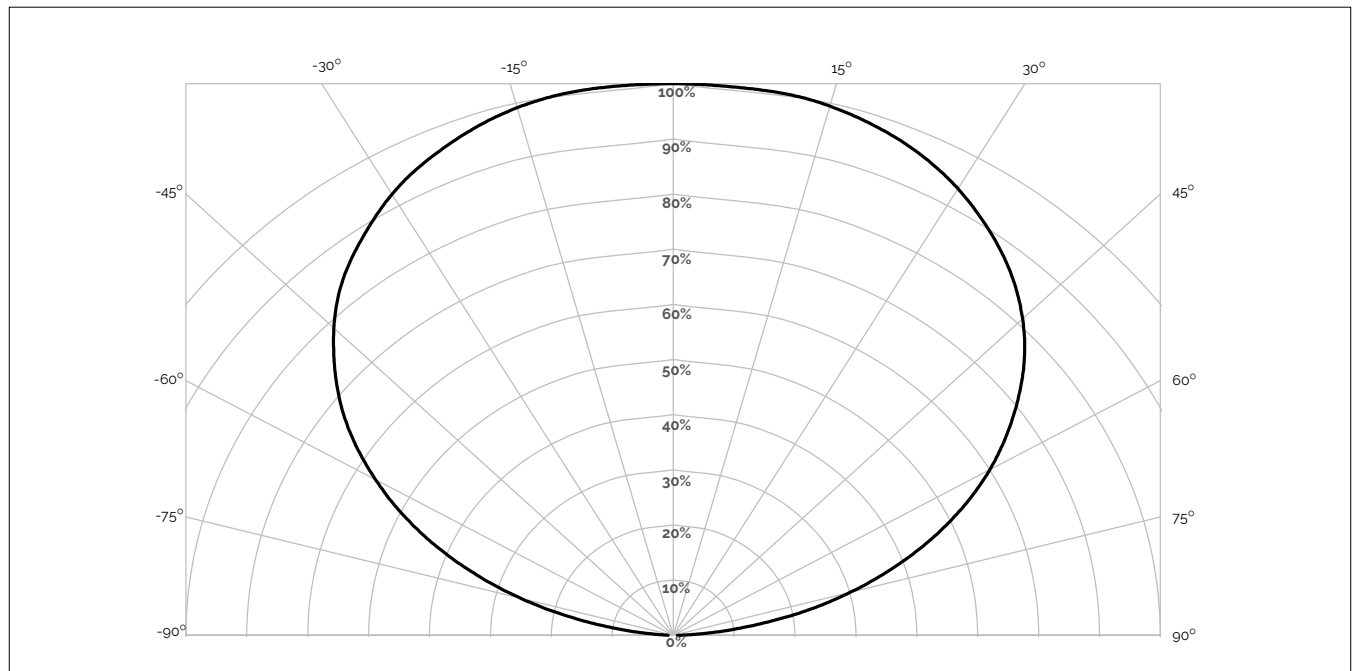

Typical Color Spectrum

Figure 18: Typical Color Spectrum

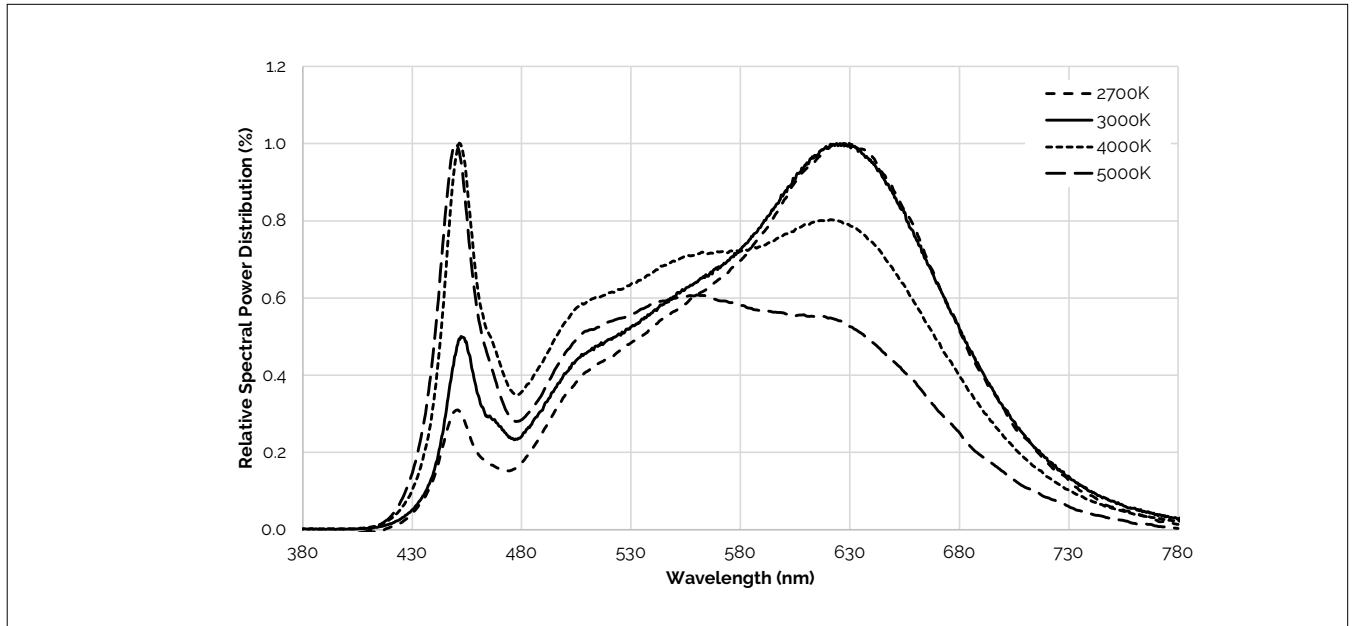

Note for Figure 18:

1. Color spectra measured at nominal current for $T_j = T_c = 25^\circ\text{C}$.

Figure 19: Typical Color Spectrum

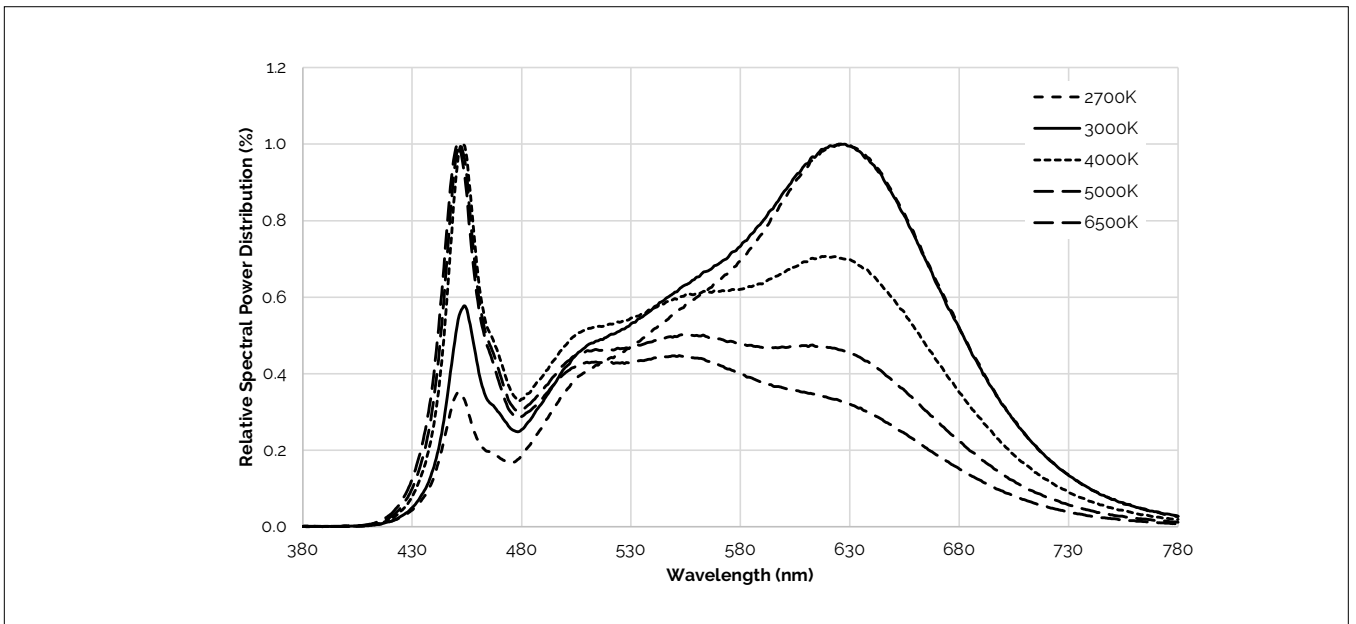

Note for Figure 19:

1. Color spectra measured at nominal current for $T_j = T_c = 25^\circ\text{C}$.

Typical Color Spectrum

Figure 20: Typical Color Spectrum

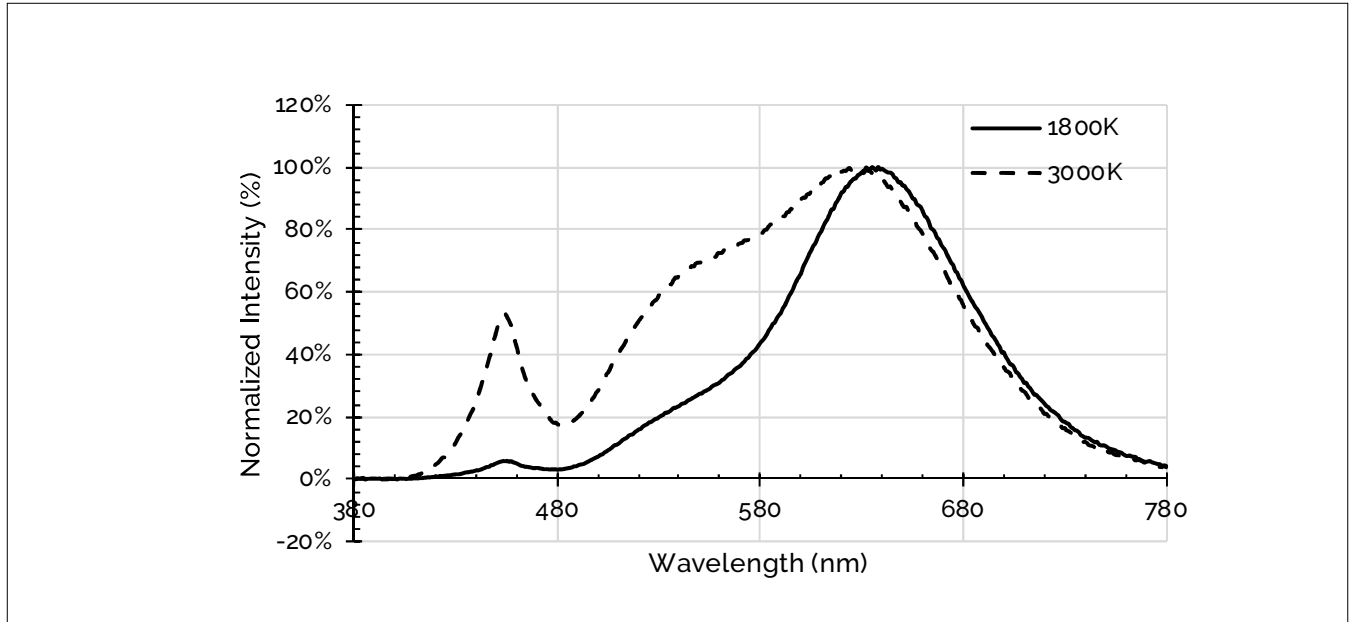

Note for Figure 20:

1. Color spectra measured at nominal current for $T_j = T_c = 25^\circ\text{C}$.

Figure 21: Typical Color Spectrum

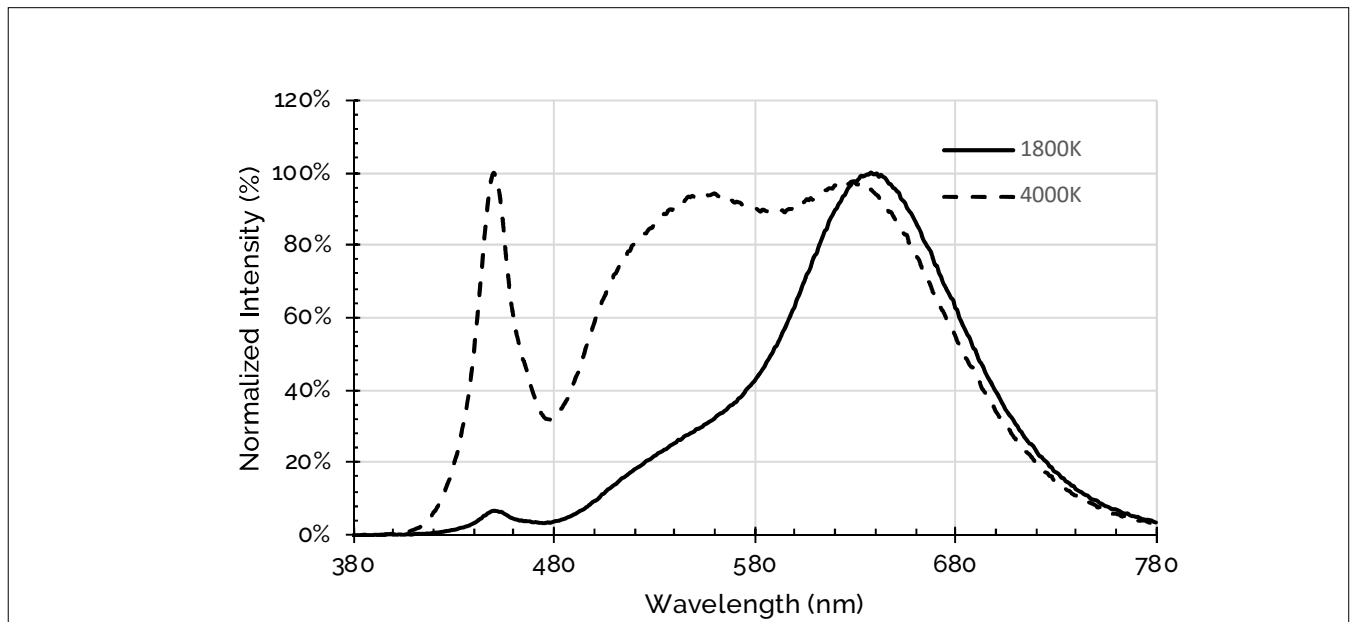

Note for Figure 21:

1. Color spectra measured at nominal current for $T_j = T_c = 25^\circ\text{C}$.

Color Binning Information

Figure 23: Graph of Bins in xy Color Space, Tc=85°C

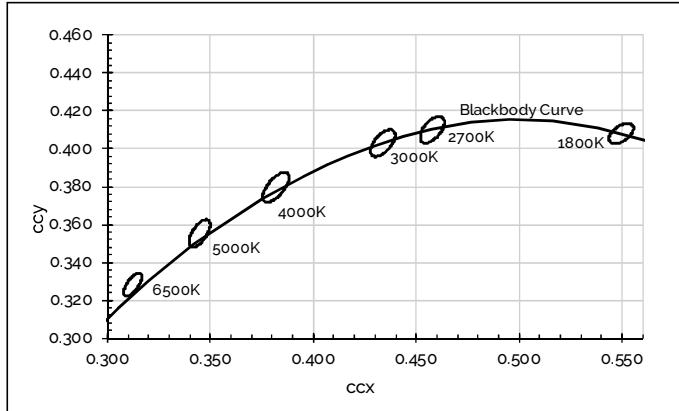

Table 4: McAdam ellipse CCT color bin definitions for product operating at $T_c = 85^\circ\text{C}$

CCT	Center Point	Bin Size	Axis a	Axis b	Rotation Angle
2700K	x=0.4578 y= 0.4101	3 SDCM	0.00810	0.00420	53.70°
5000K	x=0.3447 y=0.3553	3 SDCM	0.00822	0.00354	59.62°
6500K	x=0.3123 y=0.3282	3 SDCM	0.00690	0.00285	58.57°
1800K	x=0.5496 y=0.4081	5SDCM	0.00655	0.01165	130.00°
3000K	x=0.4338 y=0.4030	3SDCM	0.00834	0.00408	53.22°
4000K	x=0.3818 y=0.3797	3SDCM	0.00939	0.00402	53.72°

Notes for table 4:

1. The x,y center points are the center points of the respective ANSI bins in the CIE 1931 xy Color Space
2. Products are binned at Tc=85°C
3. Bridgelux maintains a tolerance of +/-0.007 on x and y color coordinates in the CIE 1931 Color Space

Figure 24: Definition of the McAdam ellipse

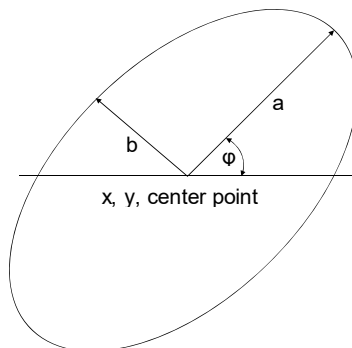

Packaging and Labeling

Figure 25: Vesta Series Tunable White 13mm Packaging and Labeling

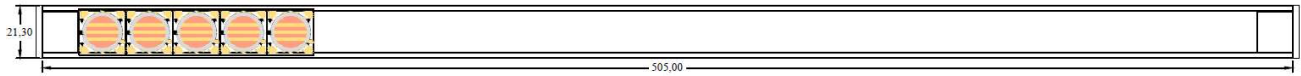

Tube label

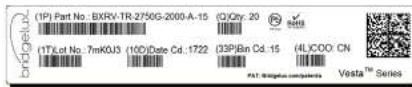

Bag label

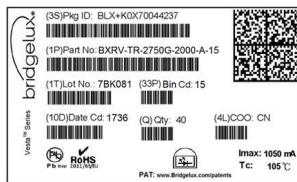

Box label



Notes for Figure 25:

1. Each tube holds 25 Vesta Series Tunable White 13mm arrays.
2. Four tubes are sealed in an anti-static bag. Up to five such bags are placed in a box and shipped. Depending on quantities ordered, a bigger shipping box, containing four boxes will be used to ship products.
3. Each bag and box is to be labeled as shown above.
4. Dimensions for each tube are 505,0 mm (L) x 21,3 mm (W) x 9,5 mm (H). Dimensions for the anti-static bag are 100,0 mm (W) x 625,0 mm (L) x 0,1 mm (T) and that of the inner box are 58,7 mm (L) x 13,3 mm (W) x 7,9 mm (H).

Design Resources

Application Notes

Vesta Series Tunable White arrays are intended for use in dry, indoor applications. Bridgelux has developed a comprehensive set of application notes and design resources to assist customers in successfully designing with the Vesta Series product family of LED array products. For a list of resources under development, visit www.bridgelux.com.

Optical Source Models

Optical source models and ray set files are available for all Bridgelux products. For a list of available formats, visit www.bridgelux.com.

3D CAD Models

Three dimensional CAD models depicting the product outline of all Bridgelux Vesta Series LED arrays are available in both IGS and STEP formats. Please contact your Bridgelux sales representative for assistance.

LM80

Please contact your Bridgelux sales representative for more information.

Precautions

CAUTION: CHEMICAL EXPOSURE HAZARD

Exposure to some chemicals commonly used in luminaire manufacturing and assembly can cause damage to the LED array. Please consult Bridgelux Application Note for additional information.

CAUTION: EYE SAFETY

Eye safety classification for the use of Bridgelux Vesta Series is in accordance with IEC/TR62778 specification 'IEC 62471 for the assessment of blue light hazard to light source and luminaires'. Vesta Series Tunable White arrays are classified as Risk Group 1 when operated at or below the maximum drive current. Please use appropriate precautions. It is important that employees working with LEDs are trained to use them safely.

CAUTION: RISK OF BURN

Do not touch the Vesta Series LED array during operation. Allow the array to cool for a sufficient period of time before handling. The Vesta Series LED array may reach elevated temperatures such that could burn skin when touched.

CAUTION

CONTACT WITH LIGHT EMITTING SURFACE (LES)

Avoid any contact with the LES. Do not touch the LES of the LED array or apply stress to the LES (yellow phosphor resin area). Contact may cause damage to the LED array.

Optics and reflectors must not be mounted in contact with the LES (yellow phosphor resin area). Optical devices may be mounted on the top surface of the Vesta Series LED array. Use the mechanical features of the LED array housing, edges and/or mounting holes to locate and secure optical devices as needed.

Disclaimers

STANDARD TEST CONDITIONS

Unless otherwise stated, array testing is performed at the nominal drive current.

MINOR PRODUCT CHANGE POLICY

The rigorous qualification testing on products offered by Bridgelux provides performance assurance. Slight cosmetic changes that do not affect form, fit, or function may occur as Bridgelux continues product optimization.

About Bridgelux: Bridging Light and Life™

At Bridgelux, we help companies, industries and people experience the power and possibility of light. Since 2002, we've designed LED solutions that are high performing, energy efficient, cost effective and easy to integrate. Our focus is on light's impact on human behavior, delivering products that create better environments, experiences and returns—both experiential and financial. And our patented technology drives new platforms for commercial and industrial luminaires.

For more information about the company, please visit

bridgelux.com

twitter.com/Bridgelux

facebook.com/Bridgelux

youtube.com/user/Bridgelux

linkedin.com/company/bridgelux-inc-_2

WeChat ID: BridgeluxInChina



46430 Fremont Blvd
Fremont, CA 94538 USA
Tel (925) 583-8400
www.bridgelux.com

© 2019 Bridgelux, Inc. All rights reserved 2019. Product specifications are subject to change without notice. Bridgelux, the Bridgelux stylized logo design and Vesta are registered trademarks of Bridgelux, Inc. All other trademarks are the property of their respective owners.

Bridgelux Vesta Series Tunable White Gen 2 13mm Array Product Data Sheet DS351 Rev. C (01/2020)

单击下面可查看定价，库存，交付和生命周期等信息

[>>Bridgelux\(普瑞光电\)](#)