



Bridgelux® Gen 8 Vero® SE 29 Array

Product Data Sheet DS433



Introduction

Vero SE



The Vero[®] SE Series is a revolutionary light source system that integrates Bridgelux's eighth generation COB technology with poke-in connectivity, enabling solder-free installation. Vero SE LED light sources streamline assembly processes, lower manufacturing costs, simplify the luminaire design process, improve light quality, and increase design flexibility.

Vero SE is available in four different light emitting surface (LES) configurations that operate reliably over a broad current range. With Vero SE, secondary connector and holder components are not required, allowing for rapid integration of arrays into fixtures, and an efficient field replaceable solution. Vero SE arrays deliver increased lumen density for improved beam control and precision lighting, with 2 and 3 SDCM color control standards for clean and consistent uniform lighting.

Features

- Poke-in electrical connectivity
- Top side part number markings
- Efficacy of 185 lm/W typical, 3000K 80 CRI
- Reliable operation at up to 3x nominal current, 30% increase in maximum lumens per LES size
- Wide selection of CCT options (2700K-6500K) with minimum 70, 80 and 90 CRI options
- Uniform high-quality illumination
- 2 and 3 SDCM binning options (2700K – 4000K)
- Forward voltage bin codes (backside marking)
- 10-Year warranty

Benefits

- Low cost, solderless, connector free installation and field upgradability
- Improved inventory management and quality control
- Enables high efficiency lighting systems and lower operating costs
- Supports the trend toward luminaire miniaturization and delivers enhanced optical control
- Design flexibility for a broad range of lighting applications
- Clean white light without pixelation
- Uniform consistent white light
- Design flexibility for multi-source applications
- Design with confidence



Contents

Product Feature Map	2
Product Nomenclature	2
Product Selection Guide	3
Performance at Commonly Used Drive Currents	7
Electrical Characteristics	16
Eye Safety	17
Absolute Maximum Ratings	18
Performance Curves	19
Typical Radiation Pattern	21
Typical Color Spectrum	23
Mechanical Dimensions	24
Color Binning Information	25
Packaging and Labeling	26
Design Resources	28
Precautions	28
Disclaimers	28
About Bridgelux	29

Product Selection Guide

The following product configurations are available:

Table 1: Selection Guide, Pulsed Measurement Data ($T_j = T_c = 25^\circ\text{C}$)

Part Number	Nominal CCT ¹ (K)	CRI ²	Nominal Drive Current ³ (mA)	Typical Pulsed Flux ^{4,5,6} $T_c = 25^\circ\text{C}$ (lm)	Minimum Pulsed Flux ^{6,7} $T_c = 25^\circ\text{C}$ (lm)	Typical V_f (V)	Typical Power (W)	Typical Efficacy (lm/W)
BXRC-27E10K0-B-8x-SE	2700	80	1400	12216	10994	50.2	70.3	174
BXRC-27E10K0-C-8x-SE	2700	80	1300	15062	13555	66.7	86.7	174
BXRC-27E10K0-D-8x-SE	2700	80	1700	10744	9670	36.4	61.9	174
BXRC-27G10K0-B-8x-SE	2700	90	1400	10078	9070	50.2	70.3	143
BXRC-27G10K0-C-8x-SE	2700	90	1300	12426	11183	66.7	86.7	143
BXRC-27G10K0-D-8x-SE	2700	90	1700	8864	7977	36.4	61.9	143
BXRC-27G1KH0-B-8x-SE	2700	90	1400	10513	9462	50.2	70.3	150
BXRC-27G1KH0-C-8x-SE	2700	90	1300	12962	11666	66.7	86.7	149
BXRC-27G1KH0-D-8x-SE	2700	90	1700	9246	8322	36.4	61.9	149
BXRC-30C10K1-B-8x-SE	3000	70	1400	13590	12231	50.2	70.3	193
BXRC-30C10K1-C-8x-SE	3000	70	1300	16756	15080	66.7	86.7	193
BXRC-30C10K1-D-8x-SE	3000	70	1700	11953	10757	36.4	61.9	193
BXRC-30E10K0-B-8x-SE	3000	80	1400	12979	11682	50.2	70.3	185
BXRC-30E10K0-C-8x-SE	3000	80	1300	16003	14403	66.7	86.7	185
BXRC-30E10K0-D-8x-SE	3000	80	1700	11415	10274	36.4	61.9	184
BXRC-30G10K0-B-8x-SE	3000	90	1400	10536	9483	50.2	70.3	150
BXRC-30G10K0-C-8x-SE	3000	90	1300	12991	11692	66.7	86.7	150
BXRC-30G10K0-D-8x-SE	3000	90	1700	9267	8340	36.4	61.9	150
BXRC-30G1KH0-B-8x-SE	3000	90	1400	11033	9929	50.2	70.3	157
BXRC-30G1KH0-C-8x-SE	3000	90	1300	13602	12242	66.7	86.7	157
BXRC-30G1KH0-D-8x-SE	3000	90	1700	9703	8733	36.4	61.9	157
BXRC-35E10K0-B-8x-SE	3500	80	1400	13285	11956	50.2	70.3	189
BXRC-35E10K0-C-8x-SE	3500	80	1300	16379	14741	66.7	86.7	189
BXRC-35E10K0-D-8x-SE	3500	80	1700	11684	10516	36.4	61.9	189
BXRC-35G10K0-B-8x-SE	3500	90	1400	10918	9826	50.2	70.3	155
BXRC-35G10K0-C-8x-SE	3500	90	1300	13461	12115	66.7	86.7	155
BXRC-35G10K0-D-8x-SE	3500	90	1700	9602	8642	36.4	61.9	155
BXRC-40C10K1-B-8x-SE	4000	70	1400	13972	12575	50.2	70.3	199
BXRC-40C10K1-C-8x-SE	4000	70	1300	17227	15504	66.7	86.7	199
BXRC-40C10K1-D-8x-SE	4000	70	1700	12288	11059	36.4	61.9	199
BXRC-40E10K0-B-8x-SE	4000	80	1400	13361	12025	50.2	70.3	190
BXRC-40E10K0-C-8x-SE	4000	80	1300	16474	14826	66.7	86.7	190
BXRC-40E10K0-D-8x-SE	4000	80	1700	11751	10576	36.4	61.9	190
BXRC-40G10K0-B-8x-SE	4000	90	1400	11147	10032	50.2	70.3	159
BXRC-40G10K0-C-8x-SE	4000	90	1300	13744	12369	66.7	86.7	159
BXRC-40G10K0-D-8x-SE	4000	90	1700	9804	8823	36.4	61.9	158

Notes for Table 1:

- Nominal CCT as defined by ANSI C78.377-2011. Products with a CCT of 5000K-6500K are hot targeted to $T_c = 85^\circ\text{C}$.
- CRI values are minimums for all products. Minimum Rg value for 80 CRI products is 0, the minimum Rg values for 90 CRI products is 50. Bridgelux maintains a ± 3 tolerance on CRI and Rg values.
- Drive current is referred to as nominal drive current.
- Products tested under pulsed condition (10ms pulse width) at nominal test current where T_j (junction temperature) = T_c (case temperature) = 25°C .
- Typical performance values are provided as a reference only and are not a guarantee of performance.
- Bridgelux maintains a $\pm 7\%$ tolerance on flux measurements.
- Minimum flux values at the nominal test current are guaranteed by 100% test.

Product Selection Guide

Table 1: Selection Guide, Pulsed Measurement Data ($T_j = T_c = 25^\circ\text{C}$) (continued)

Part Number	Nominal CCT ¹ (K)	CRI ²	Nominal Drive Current ³ (mA)	Typical Pulsed Flux ^{4,5,6} $T_c = 25^\circ\text{C}$ (lm)	Minimum Pulsed Flux ^{6,7} $T_c = 25^\circ\text{C}$ (lm)	Typical V_f (V)	Typical Power (W)	Typical Efficacy (lm/W)
BXRC-50C10K1-B-8x-SE	5000	70	1400	14048	12644	50.2	70.3	200
BXRC-50C10K1-C-8x-SE	5000	70	1300	17321	15589	66.7	86.7	200
BXRC-50C10K1-D-8x-SE	5000	70	1700	12355	11120	36.4	61.9	200
BXRC-50E10K1-B-8x-SE	5000	80	1400	13514	12163	50.2	70.3	192
BXRC-50E10K1-C-8x-SE	5000	80	1300	16662	14996	66.7	86.7	192
BXRC-50E10K1-D-8x-SE	5000	80	1700	11885	10697	36.4	61.9	192
BXRC-50G10K1-B-8x-SE	5000	90	1400	11682	10513	50.2	70.3	166
BXRC-50G10K1-C-8x-SE	5000	90	1300	14403	12962	66.7	86.7	166
BXRC-50G10K1-D-8x-SE	5000	90	1700	10274	9246	36.4	61.9	166
BXRC-57C10K1-B-8x-SE	5700	70	1400	13667	12300	50.2	70.3	194
BXRC-57C10K1-C-8x-SE	5700	70	1300	16850	15165	66.7	86.7	194
BXRC-57C10K1-D-8x-SE	5700	70	1700	12020	10818	36.4	61.9	194
BXRC-57E10K1-B-8x-SE	5700	80	1400	12979	11682	50.2	70.3	185
BXRC-57E10K1-C-8x-SE	5700	80	1300	16003	14403	66.7	86.7	185
BXRC-57E10K1-D-8x-SE	5700	80	1700	11415	10274	36.4	61.9	184
BXRC-65C10K1-B-8x-SE	6500	70	1400	13667	12300	50.2	70.3	194
BXRC-65C10K1-C-8x-SE	6500	70	1300	16850	15165	66.7	86.7	194
BXRC-65C10K1-D-8x-SE	6500	70	1700	12020	10818	36.4	61.9	194
BXRC-65E10K1-B-8x-SE	6500	80	1400	13132	11819	50.2	70.3	187
BXRC-65E10K1-C-8x-SE	6500	80	1300	16191	14572	66.7	86.7	187
BXRC-65E10K1-D-8x-SE	6500	80	1700	11550	10395	36.4	61.9	187

Notes for Table 1:

- Nominal CCT as defined by ANSI C78.377-2011. Products with a CCT of 5000K-6500K are hot targeted to $T_c = 85^\circ\text{C}$.
- CRI values are minimums for all products. Minimum Rg value for 80 CRI products is 0, the minimum Rg values for 90 CRI products is 50. Bridgelux maintains a ± 3 tolerance on CRI and Rg values.
- Drive current is referred to as nominal drive current.
- Products tested under pulsed condition (10ms pulse width) at nominal test current where T_j (junction temperature) - T_c (case temperature) = 25°C .
- Typical performance values are provided as a reference only and are not a guarantee of performance.
- Bridgelux maintains a $\pm 7\%$ tolerance on flux measurements.
- Minimum flux values at the nominal test current are guaranteed by 100% test.

Product Selection Guide

Table 2: Selection Guide, Stabilized DC Performance ($T_c = 85^\circ\text{C}$)^{4,5}

Part Number	Nominal CCT ¹ (K)	CRI ²	Nominal Drive Current ³ (mA)	Typical DC Flux ^{4,5} $T_c = 85^\circ\text{C}$ (lm)	Minimum DC Flux ⁶ $T_c = 85^\circ\text{C}$ (lm)	Typical V_f (V)	Typical Power (W)	Typical Efficacy (lm/W)
BXRC-27E10K0-B-8x-SE	2700	80	1400	10994	9895	49.2	68.9	160
BXRC-27E10K0-C-8x-SE	2700	80	1300	13555	12200	65.4	85.0	159
BXRC-27E10K0-D-8x-SE	2700	80	1700	9670	8703	35.7	60.7	159
BXRC-27G10K0-B-8x-SE	2700	90	1400	9070	8163	49.2	68.9	132
BXRC-27G10K0-C-8x-SE	2700	90	1300	11183	10065	65.4	85.0	132
BXRC-27G10K0-D-8x-SE	2700	90	1700	7977	7180	35.7	60.7	132
BXRC-27G1KH0-B-8x-SE	2700	90	1400	9462	8516	49.2	68.9	137
BXRC-27G1KH0-C-8x-SE	2700	90	1300	11666	10499	65.4	85.0	137
BXRC-27G1KH0-D-8x-SE	2700	90	1700	8322	7490	35.7	60.7	137
BXRC-30C10K1-B-8x-SE	3000	70	1400	12231	11008	49.2	68.9	178
BXRC-30C10K1-C-8x-SE	3000	70	1300	15080	13572	65.4	85.0	177
BXRC-30C10K1-D-8x-SE	3000	70	1700	10757	9682	35.7	60.7	177
BXRC-30E10K0-B-8x-SE	3000	80	1400	11682	10513	49.2	68.9	170
BXRC-30E10K0-C-8x-SE	3000	80	1300	14403	12962	65.4	85.0	169
BXRC-30E10K0-D-8x-SE	3000	80	1700	10274	9246	35.7	60.7	169
BXRC-30G10K0-B-8x-SE	3000	90	1400	9483	8534	49.2	68.9	138
BXRC-30G10K0-C-8x-SE	3000	90	1300	11692	10522	65.4	85.0	138
BXRC-30G10K0-D-8x-SE	3000	90	1700	8340	7506	35.7	60.7	137
BXRC-30G1KH0-B-8x-SE	3000	90	1400	9929	8936	49.2	68.9	144
BXRC-30G1KH0-C-8x-SE	3000	90	1300	12242	11018	65.4	85.0	144
BXRC-30G1KH0-D-8x-SE	3000	90	1700	8733	7859	35.7	60.7	144
BXRC-35E10K0-B-8x-SE	3500	80	1400	11956	10761	49.2	68.9	174
BXRC-35E10K0-C-8x-SE	3500	80	1300	14741	13267	65.4	85.0	173
BXRC-35E10K0-D-8x-SE	3500	80	1700	10516	9464	35.7	60.7	173
BXRC-35G10K0-B-8x-SE	3500	90	1400	9826	8844	49.2	68.9	143
BXRC-35G10K0-C-8x-SE	3500	90	1300	12115	10904	65.4	85.0	143
BXRC-35G10K0-D-8x-SE	3500	90	1700	8642	7778	35.7	60.7	142
BXRC-40C10K1-B-8x-SE	4000	70	1400	12575	11317	49.2	68.9	183
BXRC-40C10K1-C-8x-SE	4000	70	1300	15504	13954	65.4	85.0	182
BXRC-40C10K1-D-8x-SE	4000	70	1700	11059	9954	35.7	60.7	182
BXRC-40E10K0-B-8x-SE	4000	80	1400	12025	10823	49.2	68.9	175
BXRC-40E10K0-C-8x-SE	4000	80	1300	14826	13344	65.4	85.0	174
BXRC-40E10K0-D-8x-SE	4000	80	1700	10576	9518	35.7	60.7	174
BXRC-40G10K0-B-8x-SE	4000	90	1400	10032	9029	49.2	68.9	146
BXRC-40G10K0-C-8x-SE	4000	90	1300	12369	11132	65.4	85.0	146
BXRC-40G10K0-D-8x-SE	4000	90	1700	8823	7941	35.7	60.7	145

Notes for Table 2:

- Nominal CCT as defined by ANSI C78.377-2011. Products with a CCT of 5000K-6500K are hot targeted to $T_c = 85^\circ\text{C}$.
- All CRI values are measured at $T_j = T_c = 25^\circ\text{C}$. CRI values are minimums for all products. Minimum R_g value for 80 CRI products is 0, the minimum R_g values for 90 CRI products is 50. Bridgelux maintains a ± 3 tolerance on CRI and R_g values.
- Drive current is referred to as nominal drive current.
- Typical stabilized DC performance values are provided as reference only and are not a guarantee of performance.
- Typical performance is estimated based on operation under DC (direct current) with LED array mounted onto a heat sink with thermal interface material and the case temperature maintained at 85°C . Based on Bridgelux test setup, values may vary depending on the thermal design of the luminaire and/or the exposed environment to which the product is subjected.
- Minimum flux values at elevated temperatures are provided for reference only and are not guaranteed by 100% production testing. Based on Bridgelux test setup, values may vary depending on the thermal design of the luminaire and/or the exposed environment to which the product is subjected.

Product Selection Guide

Table 2: Selection Guide, Stabilized DC Performance ($T_c = 85^\circ\text{C}$)^{4,5} (continued)

Part Number	Nominal CCT ¹ (K)	CRI ²	Nominal Drive Current ³ (mA)	Typical DC Flux ^{4,5} $T_c = 85^\circ\text{C}$ (lm)	Minimum DC Flux ⁶ $T_c = 85^\circ\text{C}$ (lm)	Typical V_f (V)	Typical Power (W)	Typical Efficacy (lm/W)
BXRC-50C10K1-B-8x-SE	5000	70	1400	12644	11379	49.2	68.9	184
BXRC-50C10K1-C-8x-SE	5000	70	1300	15589	14030	65.4	85.0	183
BXRC-50C10K1-D-8x-SE	5000	70	1700	11120	10008	35.7	60.7	183
BXRC-50E10K1-B-8x-SE	5000	80	1400	12163	10946	49.2	68.9	177
BXRC-50E10K1-C-8x-SE	5000	80	1300	14996	13496	65.4	85.0	176
BXRC-50E10K1-D-8x-SE	5000	80	1700	10697	9627	35.7	60.7	176
BXRC-50G10K1-B-8x-SE	5000	90	1400	10513	9462	49.2	68.9	153
BXRC-50G10K1-C-8x-SE	5000	90	1300	12962	11666	65.4	85.0	153
BXRC-50G10K1-D-8x-SE	5000	90	1700	9246	8322	35.7	60.7	152
BXRC-57C10K1-B-8x-SE	5700	70	1400	12300	11070	49.2	68.9	179
BXRC-57C10K1-C-8x-SE	5700	70	1300	15165	13649	65.4	85.0	178
BXRC-57C10K1-D-8x-SE	5700	70	1700	10818	9736	35.7	60.7	178
BXRC-57E10K1-B-8x-SE	5700	80	1400	11682	10513	49.2	68.9	170
BXRC-57E10K1-C-8x-SE	5700	80	1300	14403	12962	65.4	85.0	169
BXRC-57E10K1-D-8x-SE	5700	80	1700	10274	9246	35.7	60.7	169
BXRC-65C10K1-B-8x-SE	6500	70	1400	12300	11070	49.2	68.9	179
BXRC-65C10K1-C-8x-SE	6500	70	1300	15165	13649	65.4	85.0	178
BXRC-65C10K1-D-8x-SE	6500	70	1700	10818	9736	35.7	60.7	178
BXRC-65E10K1-B-8x-SE	6500	80	1400	11819	10637	49.2	68.9	172
BXRC-65E10K1-C-8x-SE	6500	80	1300	14572	13115	65.4	85.0	171
BXRC-65E10K1-D-8x-SE	6500	80	1700	10395	9355	35.7	60.7	171

Notes for Table 2:

- Nominal CCT as defined by ANSI C78.377-2011. Products with a CCT of 5000K-6500K are hot targeted to $T_c = 85^\circ\text{C}$.
- All CRI values are measured at $T_c = T_a = 25^\circ\text{C}$. CRI values are minimums for all products. Minimum Rg value for 80 CRI products is 0, the minimum Rg values for 90 CRI products is 50. Bridgelux maintains a ± 3 tolerance on CRI and Rg values.
- Drive current is referred to as nominal drive current.
- Typical stabilized DC performance values are provided as reference only and are not a guarantee of performance.
- Typical performance is estimated based on operation under DC (direct current) with LED array mounted onto a heat sink with thermal interface material and the case temperature maintained at 85°C . Based on Bridgelux test setup, values may vary depending on the thermal design of the luminaire and/or the exposed environment to which the product is subjected.
- Minimum flux values at elevated temperatures are provided for reference only and are not guaranteed by 100% production testing. Based on Bridgelux test setup, values may vary depending on the thermal design of the luminaire and/or the exposed environment to which the product is subjected.

Performance at Commonly Used Drive Currents

Vero LED arrays are tested to the specifications shown using the nominal drive currents in Table 1. Vero SE may also be driven at other drive currents dependent on specific application design requirements. The performance at any drive current can be derived from the current vs. voltage characteristics shown in Figures 1, 2 & 3 and the flux vs. current characteristics shown in Figures 4, 5 & 6. The performance at commonly used drive currents is summarized in Table 3.

Table 3: Product Performance at Commonly Used Drive Currents

Part Number	CRI	Drive Current ¹ (mA)	Typical V _f T _c = 25°C (V)	Typical Power T _c = 25°C (W)	Typical Flux ² T _c = 25°C (lm)	Typical DC Flux ³ T _c = 85°C (lm)	Typical Efficacy T _c = 25°C (lm/W)
BXRC-27E10K0-B-8x-SE	80	700	48.5	34.0	6160	5544	181
		1050	49.4	51.9	9200	8280	177
		1400	50.2	70.3	12216	10994	174
		1800	51.2	92.1	15457	13911	168
		2800	53.3	149.1	23251	20926	156
		4750	56.6	268.8	36646	32981	136
BXRC-27E10K0-C-8x-SE	80	650	64.4	41.9	7595	6835	181
		975	65.6	64.0	11344	10209	177
		1300	66.7	86.7	15062	13555	174
		1710	68.0	116.4	19472	17525	167
		2600	70.7	183.9	28667	25800	156
		4750	75.8	360.1	47950	43155	133
BXRC-27E10K0-D-8x-SE	80	850	35.1	29.9	5418	4876	181
		1275	35.8	45.6	8092	7283	177
		1700	36.4	61.9	10744	9670	174
		2100	36.9	77.6	13090	11781	169
		3400	38.6	131.1	20449	18404	156
		5500	40.7	224.1	31002	27902	138
BXRC-27G10K0-B-8x-SE	90	700	48.5	34.0	5082	4574	150
		1050	49.4	51.9	7590	6831	146
		1400	50.2	70.3	10078	9070	143
		1800	51.2	92.1	12752	11477	138
		2800	53.3	149.1	19182	17264	129
		4750	56.6	268.8	30233	27209	112
BXRC-27G10K0-C-8x-SE	90	650	64.4	41.9	6266	5639	150
		975	65.6	64.0	9358	8423	146
		1300	66.7	86.7	12426	11183	143
		1710	68.0	116.4	16064	14458	138
		2600	70.7	183.9	23650	21285	129
		4750	75.8	360.1	39558	35603	110
BXRC-27G10K0-D-8x-SE	90	850	35.1	29.9	4470	4023	150
		1275	35.8	45.6	6676	6008	146
		1700	36.4	61.9	8864	7977	143
		2100	36.9	77.6	10799	9719	139
		3400	38.6	131.1	16870	15183	129
		5500	40.7	224.1	25577	23019	114

Notes for Table 3:

1. Alternate drive currents in Table 3 are provided for reference only and are not a guarantee of performance.
2. Bridgelux maintains a ± 7% tolerance on flux measurements.
3. Typical stabilized DC performance values are provided as reference only and are not a guarantee of performance.

Performance at Commonly Used Drive Currents

Table 3: Product Performance at Commonly Used Drive Currents (Continued)

Part Number	CRI	Drive Current ¹ (mA)	Typical V _f T _c = 25°C (V)	Typical Power T _c = 25°C (W)	Typical Flux ² T _c = 25°C (lm)	Typical DC Flux ³ T _c = 85°C (lm)	Typical Efficacy T _c = 25°C (lm/W)
BXRC-27G1KH0-B-8x-SE	90	700	48.5	34.0	5301	4771	156
		1050	49.4	51.9	7918	7126	153
		1400	50.2	70.3	10513	9462	149
		1800	51.2	92.1	13303	11972	144
		2800	53.3	149.1	20010	18009	134
		4750	56.6	268.8	31538	28384	117
BXRC-27G1KH0-C-8x-SE	90	650	64.4	41.9	6536	5883	156
		975	65.6	64.0	9762	8786	153
		1300	66.7	86.7	12962	11666	149
		1710	68.0	116.4	16758	15082	144
		2600	70.7	183.9	24671	22204	134
		4750	75.8	360.1	41267	37140	115
BXRC-27G1KH0-D-8x-SE	90	850	35.1	29.9	4663	4196	156
		1275	35.8	45.6	6964	6268	153
		1700	36.4	61.9	9246	8322	149
		2100	36.9	77.6	11265	10139	145
		3400	38.6	131.1	17599	15839	134
		5500	40.7	224.1	26681	24013	119
BXRC-30C10K1-B-8x-SE	70	700	48.5	34.0	6853	6168	202
		1050	49.4	51.9	10235	9212	197
		1400	50.2	70.3	13590	12231	193
		1800	51.2	92.1	17196	15476	187
		2800	53.3	149.1	25866	23280	173
		4750	56.6	268.8	40768	36692	152
BXRC-30C10K1-C-8x-SE	70	650	64.4	41.9	8449	7604	202
		975	65.6	64.0	12620	11358	197
		1300	66.7	86.7	16756	15080	193
		1710	68.0	116.4	21663	19496	186
		2600	70.7	183.9	31892	28703	173
		4750	75.8	360.1	53344	48010	148
BXRC-30C10K1-D-8x-SE	70	850	35.1	29.9	6027	5424	202
		1275	35.8	45.6	9002	8102	197
		1700	36.4	61.9	11953	10757	193
		2100	36.9	77.6	14562	13106	188
		3400	38.6	131.1	22749	20474	173
		5500	40.7	224.1	34490	31041	154
BXRC-30E10K0-B-8x-SE	80	700	48.5	34.0	6545	5890	193
		1050	49.4	51.9	9775	8798	188
		1400	50.2	70.3	12979	11682	185
		1800	51.2	92.1	16423	14781	178
		2800	53.3	149.1	24704	22234	166
		4750	56.6	268.8	38936	35042	145

Notes for Table 3:

1. Alternate drive currents in Table 3 are provided for reference only and are not a guarantee of performance.
2. Bridgelux maintains a ± 7% tolerance on flux measurements.
3. Typical stabilized DC performance values are provided as reference only and are not a guarantee of performance.

Performance at Commonly Used Drive Currents

Table 3: Product Performance at Commonly Used Drive Currents (Continued)

Part Number	CRI	Drive Current ¹ (mA)	Typical V _f T _c = 25°C (V)	Typical Power T _c = 25°C (W)	Typical Flux ² T _c = 25°C (lm)	Typical DC Flux ³ T _c = 85°C (lm)	Typical Efficacy T _c = 25°C (lm/W)
BXRC-30E10K0-C-8x-SE	80	650	64.4	41.9	8070	7263	193
		975	65.6	64.0	12052	10847	188
		1300	66.7	86.7	16003	14403	185
		1710	68.0	116.4	20689	18620	178
		2600	70.7	183.9	30458	27413	166
		4750	75.8	360.1	50946	45852	141
BXRC-30E10K0-D-8x-SE	80	850	35.1	29.9	5756	5181	193
		1275	35.8	45.6	8597	7738	188
		1700	36.4	61.9	11415	10274	185
		2100	36.9	77.6	13908	12517	179
		3400	38.6	131.1	21727	19554	166
		5500	40.7	224.1	32940	29646	147
BXRC-30G10K0-B-8x-SE	90	700	48.5	34.0	5313	4782	156
		1050	49.4	51.9	7935	7142	153
		1400	50.2	70.3	10536	9483	150
		1800	51.2	92.1	13332	11999	145
		2800	53.3	149.1	20054	18048	134
		4750	56.6	268.8	31607	28446	118
BXRC-30G10K0-C-8x-SE	90	650	64.4	41.9	6551	5896	156
		975	65.6	64.0	9784	8805	153
		1300	66.7	86.7	12991	11692	150
		1710	68.0	116.4	16795	15115	144
		2600	70.7	183.9	24725	22253	134
		4750	75.8	360.1	41357	37221	115
BXRC-30G10K0-D-8x-SE	90	850	35.1	29.9	4673	4205	156
		1275	35.8	45.6	6979	6281	153
		1700	36.4	61.9	9267	8340	150
		2100	36.9	77.6	11290	10161	146
		3400	38.6	131.1	17637	15873	134
		5500	40.7	224.1	26739	24065	119
BXRC-30G1KH0-B-8x-SE	90	700	48.5	34.0	5563	5007	164
		1050	49.4	51.9	8309	7478	160
		1400	50.2	70.3	11033	9929	157
		1800	51.2	92.1	13960	12564	152
		2800	53.3	149.1	20998	18898	141
		4750	56.6	268.8	33096	29786	123
BXRC-30G1KH0-C-8x-SE	90	650	64.4	41.9	6859	6173	164
		975	65.6	64.0	10245	9220	160
		1300	66.7	86.7	13602	12242	157
		1710	68.0	116.4	17586	15827	151
		2600	70.7	183.9	25890	23301	141
		4750	75.8	360.1	43304	38974	120

Notes for Table 3:

1. Alternate drive currents in Table 3 are provided for reference only and are not a guarantee of performance.
2. Bridgelux maintains a ± 7% tolerance on flux measurements.
3. Typical stabilized DC performance values are provided as reference only and are not a guarantee of performance.

Performance at Commonly Used Drive Currents

Table 3: Product Performance at Commonly Used Drive Currents (Continued)

Part Number	CRI	Drive Current ¹ (mA)	Typical V _f T _c = 25°C (V)	Typical Power T _c = 25°C (W)	Typical Flux ² T _c = 25°C (lm)	Typical DC Flux ³ T _c = 85°C (lm)	Typical Efficacy T _c = 25°C (lm/W)
BXRC-30G1KH0-D-8x-SE	90	850	35.1	29.9	4893	4404	164
		1275	35.8	45.6	7308	6577	160
		1700	36.4	61.9	9703	8733	157
		2100	36.9	77.6	11822	10639	152
		3400	38.6	131.1	18468	16621	141
		5500	40.7	224.1	27999	25199	125
BXRC-35E10K0-B-8x-SE	80	700	48.5	34.0	6699	6029	197
		1050	49.4	51.9	10005	9005	193
		1400	50.2	70.3	13285	11956	189
		1800	51.2	92.1	16809	15129	183
		2800	53.3	149.1	25285	22757	170
		4750	56.6	268.8	39852	35867	148
BXRC-35E10K0-C-8x-SE	80	650	64.4	41.9	8259	7433	197
		975	65.6	64.0	12336	11102	193
		1300	66.7	86.7	16379	14741	189
		1710	68.0	116.4	21176	19058	182
		2600	70.7	183.9	31175	28058	170
		4750	75.8	360.1	52145	46931	145
BXRC-35E10K0-D-8x-SE	80	850	35.1	29.9	5892	5303	197
		1275	35.8	45.6	8800	7920	193
		1700	36.4	61.9	11684	10516	189
		2100	36.9	77.6	14235	12812	184
		3400	38.6	131.1	22238	20014	170
		5500	40.7	224.1	33715	30343	150
BXRC-35G10K0-B-8x-SE	90	700	48.5	34.0	5505	4955	162
		1050	49.4	51.9	8223	7401	159
		1400	50.2	70.3	10918	9826	155
		1800	51.2	92.1	13815	12433	150
		2800	53.3	149.1	20780	18702	139
		4750	56.6	268.8	32752	29477	122
BXRC-35G10K0-C-8x-SE	90	650	64.4	41.9	6788	6109	162
		975	65.6	64.0	10138	9124	159
		1300	66.7	86.7	13461	12115	155
		1710	68.0	116.4	17403	15663	150
		2600	70.7	183.9	25621	23059	139
		4750	75.8	360.1	42855	38569	119
BXRC-35G10K0-D-8x-SE	90	850	35.1	29.9	4842	4358	162
		1275	35.8	45.6	7232	6509	159
		1700	36.4	61.9	9602	8642	155
		2100	36.9	77.6	11699	10529	151
		3400	38.6	131.1	18276	16449	139
		5500	40.7	224.1	27708	24937	124

Notes for Table 3:

1. Alternate drive currents in Table 3 are provided for reference only and are not a guarantee of performance.
2. Bridgelux maintains a ± 7% tolerance on flux measurements.
3. Typical stabilized DC performance values are provided as reference only and are not a guarantee of performance.

Performance at Commonly Used Drive Currents

Table 3: Product Performance at Commonly Used Drive Currents (Continued)

Part Number	CRI	Drive Current ¹ (mA)	Typical V _f T _c = 25°C (V)	Typical Power T _c = 25°C (W)	Typical Flux ² T _c = 25°C (lm)	Typical DC Flux ³ T _c = 85°C (lm)	Typical Efficacy T _c = 25°C (lm/W)
BXRC-40C10K1-B-8x-SE	70	700	48.5	34.0	7045	6341	207
		1050	49.4	51.9	10523	9471	203
		1400	50.2	70.3	13972	12575	199
		1800	51.2	92.1	17679	15911	192
		2800	53.3	149.1	26593	23934	178
		4750	56.6	268.8	41914	37722	156
BXRC-40C10K1-C-8x-SE	70	650	64.4	41.9	8687	7818	207
		975	65.6	64.0	12974	11677	203
		1300	66.7	86.7	17227	15504	199
		1710	68.0	116.4	22271	20044	191
		2600	70.7	183.9	32788	29509	178
		4750	75.8	360.1	54842	49358	152
BXRC-40C10K1-D-8x-SE	70	850	35.1	29.9	6196	5577	207
		1275	35.8	45.6	9255	8329	203
		1700	36.4	61.9	12288	11059	199
		2100	36.9	77.6	14971	13474	193
		3400	38.6	131.1	23388	21050	178
		5500	40.7	224.1	35459	31913	158
BXRC-40E10K0-B-8x-SE	80	700	48.5	34.0	6737	6064	198
		1050	49.4	51.9	10063	9057	194
		1400	50.2	70.3	13361	12025	190
		1800	51.2	92.1	16906	15215	184
		2800	53.3	149.1	25430	22887	171
		4750	56.6	268.8	40081	36073	149
BXRC-40E10K0-C-8x-SE	80	650	64.4	41.9	8307	7476	198
		975	65.6	64.0	12407	11166	194
		1300	66.7	86.7	16474	14826	190
		1710	68.0	116.4	21298	19168	183
		2600	70.7	183.9	31354	28219	171
		4750	75.8	360.1	52445	47200	146
BXRC-40E10K0-D-8x-SE	80	850	35.1	29.9	5926	5333	198
		1275	35.8	45.6	8850	7965	194
		1700	36.4	61.9	11751	10576	190
		2100	36.9	77.6	14317	12885	185
		3400	38.6	131.1	22366	20129	171
		5500	40.7	224.1	33909	30518	151
BXRC-40G10K0-B-8x-SE	90	700	48.5	34.0	5621	5059	165
		1050	49.4	51.9	8395	7556	162
		1400	50.2	70.3	11147	10032	158
		1800	51.2	92.1	14105	12694	153
		2800	53.3	149.1	21216	19095	142
		4750	56.6	268.8	33439	30095	124

Notes for Table 3:

1. Alternate drive currents in Table 3 are provided for reference only and are not a guarantee of performance.
2. Bridgelux maintains a ± 7% tolerance on flux measurements.
3. Typical stabilized DC performance values are provided as reference only and are not a guarantee of performance.

Performance at Commonly Used Drive Currents

Table 3: Product Performance at Commonly Used Drive Currents (Continued)

Part Number	CRI	Drive Current ¹ (mA)	Typical V _f T _c = 25°C (V)	Typical Power T _c = 25°C (W)	Typical Flux ² T _c = 25°C (lm)	Typical DC Flux ³ T _c = 85°C (lm)	Typical Efficacy T _c = 25°C (lm/W)
BXRC-40G10K0-C-8x-SE	90	650	64.4	41.9	6930	6237	165
		975	65.6	64.0	10351	9316	162
		1300	66.7	86.7	13744	12369	158
		1710	68.0	116.4	17768	15991	153
		2600	70.7	183.9	26158	23543	142
		4750	75.8	360.1	43754	39379	122
BXRC-40G10K0-D-8x-SE	90	850	35.1	29.9	4944	4449	165
		1275	35.8	45.6	7384	6645	162
		1700	36.4	61.9	9804	8823	158
		2100	36.9	77.6	11944	10750	154
		3400	38.6	131.1	18660	16794	142
		5500	40.7	224.1	28290	25461	126
BXRC-50C10K1-B-8x-SE	70	700	48.5	34.0	7084	6376	209
		1050	49.4	51.9	10580	9522	204
		1400	50.2	70.3	14048	12644	200
		1800	51.2	92.1	17776	15998	193
		2800	53.3	149.1	26738	24065	179
		4750	56.6	268.8	42143	37928	157
BXRC-50C10K1-C-8x-SE	70	650	64.4	41.9	8734	7861	209
		975	65.6	64.0	13045	11741	204
		1300	66.7	86.7	17321	15589	200
		1710	68.0	116.4	22393	20154	192
		2600	70.7	183.9	32967	29670	179
		4750	75.8	360.1	55142	49628	153
BXRC-50C10K1-D-8x-SE	70	850	35.1	29.9	6230	5607	209
		1275	35.8	45.6	9305	8375	204
		1700	36.4	61.9	12355	11120	200
		2100	36.9	77.6	15053	13548	194
		3400	38.6	131.1	23516	21165	179
		5500	40.7	224.1	35653	32087	159
BXRC-50E10K1-B-8x-SE	80	700	48.5	34.0	6814	6133	201
		1050	49.4	51.9	10178	9160	196
		1400	50.2	70.3	13514	12163	192
		1800	51.2	92.1	17099	15389	186
		2800	53.3	149.1	25721	23149	172
		4750	56.6	268.8	40539	36485	151
BXRC-50E10K1-C-8x-SE	80	650	64.4	41.9	8402	7562	201
		975	65.6	64.0	12549	11294	196
		1300	66.7	86.7	16662	14996	192
		1710	68.0	116.4	21541	19387	185
		2600	70.7	183.9	31713	28541	172
		4750	75.8	360.1	53044	47740	147

Notes for Table 3:

1. Alternate drive currents in Table 3 are provided for reference only and are not a guarantee of performance.
2. Bridgelux maintains a ± 7% tolerance on flux measurements.
3. Typical stabilized DC performance values are provided as reference only and are not a guarantee of performance.

Performance at Commonly Used Drive Currents

Table 3: Product Performance at Commonly Used Drive Currents (Continued)

Part Number	CRI	Drive Current ¹ (mA)	Typical V _f T _c = 25°C (V)	Typical Power T _c = 25°C (W)	Typical Flux ² T _c = 25°C (lm)	Typical DC Flux ³ T _c = 85°C (lm)	Typical Efficacy T _c = 25°C (lm/W)
BXRC-50E10K1-D-8x-SE	80	850	35.1	29.9	5993	5394	201
		1275	35.8	45.6	8951	8056	196
		1700	36.4	61.9	11885	10697	192
		2100	36.9	77.6	14480	13032	187
		3400	38.6	131.1	22622	20359	172
		5500	40.7	224.1	34296	30867	153
BXRC-50G10K1-B-8x-SE	90	700	48.5	34.0	5890	5301	173
		1050	49.4	51.9	8798	7918	170
		1400	50.2	70.3	11682	10513	166
		1800	51.2	92.1	14781	13303	161
		2800	53.3	149.1	22234	20010	149
		4750	56.6	268.8	35042	31538	130
BXRC-50G10K1-C-8x-SE	90	650	64.4	41.9	7263	6536	173
		975	65.6	64.0	10847	9762	170
		1300	66.7	86.7	14403	12962	166
		1710	68.0	116.4	18620	16758	160
		2600	70.7	183.9	27413	24671	149
		4750	75.8	360.1	45852	41267	127
BXRC-50G10K1-D-8x-SE	90	850	35.1	29.9	5181	4663	173
		1275	35.8	45.6	7738	6964	170
		1700	36.4	61.9	10274	9246	166
		2100	36.9	77.6	12517	11265	161
		3400	38.6	131.1	19554	17599	149
		5500	40.7	224.1	29646	26681	132
BXRC-57C10K1-B-8x-SE	70	700	48.5	34.0	6891	6202	203
		1050	49.4	51.9	10293	9264	198
		1400	50.2	70.3	13667	12300	194
		1800	51.2	92.1	17293	15563	188
		2800	53.3	149.1	26012	23411	174
		4750	56.6	268.8	40997	36898	153
BXRC-57C10K1-C-8x-SE	70	650	64.4	41.9	8497	7647	203
		975	65.6	64.0	12691	11421	198
		1300	66.7	86.7	16850	15165	194
		1710	68.0	116.4	21784	19606	187
		2600	70.7	183.9	32071	28864	174
		4750	75.8	360.1	53644	48279	149
BXRC-57C10K1-D-8x-SE	70	850	35.1	29.9	6061	5455	203
		1275	35.8	45.6	9053	8147	198
		1700	36.4	61.9	12020	10818	194
		2100	36.9	77.6	14644	13180	189
		3400	38.6	131.1	22877	20590	174
		5500	40.7	224.1	34684	31215	155

Notes for Table 3:

1. Alternate drive currents in Table 3 are provided for reference only and are not a guarantee of performance.
2. Bridgelux maintains a ± 7% tolerance on flux measurements.
3. Typical stabilized DC performance values are provided as reference only and are not a guarantee of performance.

Performance at Commonly Used Drive Currents

Table 3: Product Performance at Commonly Used Drive Currents (Continued)

Part Number	CRI	Drive Current ¹ (mA)	Typical V _f T _c = 25°C (V)	Typical Power T _c = 25°C (W)	Typical Flux ² T _c = 25°C (lm)	Typical DC Flux ³ T _c = 85°C (lm)	Typical Efficacy T _c = 25°C (lm/W)
BXRC-57E10K1-B-8x-SE	80	700	48.5	34.0	6545	5890	193
		1050	49.4	51.9	9775	8798	188
		1400	50.2	70.3	12979	11682	185
		1800	51.2	92.1	16423	14781	178
		2800	53.3	149.1	24704	22234	166
		4750	56.6	268.8	38936	35042	145
BXRC-57E10K1-C-8x-SE	80	650	64.4	41.9	8070	7263	193
		975	65.6	64.0	12052	10847	188
		1300	66.7	86.7	16003	14403	185
		1710	68.0	116.4	20689	18620	178
		2600	70.7	183.9	30458	27413	166
		4750	75.8	360.1	50946	45852	141
BXRC-57E10K1-D-8x-SE	80	850	35.1	29.9	5756	5181	193
		1275	35.8	45.6	8597	7738	188
		1700	36.4	61.9	11415	10274	185
		2100	36.9	77.6	13908	12517	179
		3400	38.6	131.1	21727	19554	166
		5500	40.7	224.1	32940	29646	147
BXRC-65C10K1-B-8x-SE	70	700	48.5	34.0	6891	6202	203
		1050	49.4	51.9	10293	9264	198
		1400	50.2	70.3	13667	12300	194
		1800	51.2	92.1	17293	15563	188
		2800	53.3	149.1	26012	23411	174
		4750	56.6	268.8	40997	36898	153
BXRC-65C10K1-C-8x-SE	70	650	64.4	41.9	8497	7647	203
		975	65.6	64.0	12691	11421	198
		1300	66.7	86.7	16850	15165	194
		1710	68.0	116.4	21784	19606	187
		2600	70.7	183.9	32071	28864	174
		4750	75.8	360.1	53644	48279	149
BXRC-65C10K1-D-8x-SE	70	850	35.1	29.9	6061	5455	203
		1275	35.8	45.6	9053	8147	198
		1700	36.4	61.9	12020	10818	194
		2100	36.9	77.6	14644	13180	189
		3400	38.6	131.1	22877	20590	174
		5500	40.7	224.1	34684	31215	155
BXRC-65E10K1-B-8x-SE	80	700	48.5	34.0	6622	5960	195
		1050	49.4	51.9	9890	8901	191
		1400	50.2	70.3	13132	11819	187
		1800	51.2	92.1	16616	14955	180
		2800	53.3	149.1	24995	22495	168
		4750	56.6	268.8	39394	35455	147

Notes for Table 3:

1. Alternate drive currents in Table 3 are provided for reference only and are not a guarantee of performance.
2. Bridgelux maintains a ± 7% tolerance on flux measurements.
3. Typical stabilized DC performance values are provided as reference only and are not a guarantee of performance.

Performance at Commonly Used Drive Currents

Table 3: Product Performance at Commonly Used Drive Currents (Continued)

Part Number	CRI	Drive Current ¹ (mA)	Typical V_f $T_c = 25^\circ\text{C}$ (V)	Typical Power $T_c = 25^\circ\text{C}$ (W)	Typical Flux ² $T_c = 25^\circ\text{C}$ (lm)	Typical DC Flux ³ $T_c = 85^\circ\text{C}$ (lm)	Typical Efficacy $T_c = 25^\circ\text{C}$ (lm/W)
BXRC-65E10K1-C-8x-SE	80	650	64.4	41.9	8164	7348	195
		975	65.6	64.0	12194	10975	191
		1300	66.7	86.7	16191	14572	187
		1710	68.0	116.4	20932	18839	180
		2600	70.7	183.9	30817	27735	168
		4750	75.8	360.1	51546	46391	143
BXRC-65E10K1-D-8x-SE	80	850	35.1	29.9	5824	5242	195
		1275	35.8	45.6	8699	7829	191
		1700	36.4	61.9	11550	10395	187
		2100	36.9	77.6	14071	12664	181
		3400	38.6	131.1	21983	19784	168
		5500	40.7	224.1	33327	29995	149

Notes for Table 3:

1. Alternate drive currents in Table 3 are provided for reference only and are not a guarantee of performance.
2. Bridgelux maintains a $\pm 7\%$ tolerance on flux measurements.
3. Typical stabilized DC performance values are provided as reference only and are not a guarantee of performance.

Electrical Characteristics

Table 4: Electrical Characteristics

Part Number	Drive Current (mA)	Forward Voltage Pulsed, $T_c = 25^\circ\text{C}$ (V) ^{1, 2, 3, 8}			Typical Coefficient of Forward Voltage ⁴ $\Delta V_f / \Delta T_c$ (mV/ $^\circ\text{C}$)	Typical Thermal Resistance Junction to Case ^{5,6} R_{j-c} ($^\circ\text{C}/\text{W}$)	Driver Selection Voltages ⁷ (V)	
		Minimum	Typical	Maximum			V_f Min. Hot $T_c = 105^\circ\text{C}$ (V)	V_f Max. Cold $T_c = -40^\circ\text{C}$ (V)
BXRC-xxx10Kx-B-8x-SE	1400	46.4	50.2	54.0	-16.19	0.05	45.1	55.0
	4750	52.4	56.6	60.8	-18.26	0.10	50.9	62.0
BXRC-xxx10Kx-C-8x-SE	1300	61.7	66.7	71.7	-21.51	0.05	60.0	73.1
	4750	70.1	75.8	81.5	-24.45	0.11	68.2	83.1
BXRC-xxx10Kx-D-8x-SE	1700	33.7	36.4	39.1	-11.74	0.06	32.7	39.9
	5500	37.6	40.7	43.8	-13.13	0.11	36.6	44.6

Notes for Table 4:

- Parts are tested in pulsed conditions, $T_c = 25^\circ\text{C}$. Pulse width is 10ms.
- Voltage minimum and maximum are provided for reference only and are not a guarantee of performance.
- Bridgelux maintains a tester tolerance of $\pm 0.10\text{V}$ on forward voltage measurements.
- Typical coefficient of forward voltage tolerance is $\pm 0.1\text{mV}$ for nominal current.
- Thermal resistance values are based from test data of a 3000K 80 CRI product.
- Thermal resistance value was calculated using total electrical input power; optical power was not subtracted from input power. The thermal interface material used during testing is not included in the thermal resistance value.
- V_f min hot and max cold values are provided as reference only and are not guaranteed by test. These values are provided to aid in driver design and selection over the operating range of the product.
- This product has been designed and manufactured per IEC 62031:2014. This product has passed dielectric withstand voltage testing at 1140 V. The working voltage designated for the insulation is 70V d.c. The maximum allowable voltage across the array must be determined in the end product application.

Eye Safety

Table 5: Eye Safety Risk Group (RG) Classifications

Part Number	Drive Current (mA)	CCT			
		2700K/3000K	4000K ²	5000K ³	6500K ⁴
BXRC-xxx10Kx-B-8x-SE	2145	RG1	RG1	RG1	RG1
	2970	RG1	RG1	RG1	RG2
	3945	RG1	RG1	RG2	RG2
	4750	RG1	RG2	RG2	RG2
BXRC-xxx10Kx-C-8x-SE	1615	RG1	RG1	RG1	RG1
	2235	RG1	RG1	RG1	RG2
	2970	RG1	RG1	RG2	RG2
	4750	RG1	RG2	RG2	RG2
BXRC-xxx10Kx-D-8x-SE	2960	RG1	RG1	RG1	RG1
	4100	RG1	RG1	RG1	RG2
	5500	RG1	RG1	RG2	RG2

Notes for Table 5:

1. Eye safety classification for the use of Bridgelux V Series LED arrays is in accordance with specification IEC/TR 62778: Application of IEC 62471 for the assessment of blue light hazard to light sources and luminaires.
2. For products classified as RG2 at 4000K, Ethr= 1980 lx.
3. For products classified as RG2 at 5000K Ethr= 1530 lx.
4. For products classified as RG2 at 6500K, Ethr= 1170 lx.
5. Please contact your Bridgelux sales representative for Ethr values at specific drive currents and CCTs not listed.

Absolute Maximum Ratings

Table 6: Maximum Ratings

Parameter	Maximum Rating		
LED Junction Temperature (T_j)	150°C		
Storage Temperature	-40°C to +105°C		
Operating Case Temperature ¹ (T_c)	105°C		
Soldering Temperature ²	300°C or lower for a maximum of 6 seconds		
	BXRC-xxx10Kx-B-8x-SE	BXRC-xxx10Kx-C-8x-SE	BXRC-xxx10Kx-D-8x-SE
Maximum Drive Current ³	4750 mA	4750 mA	5500 mA
Maximum Peak Pulsed Drive Current ^{4,5}	5320 mA	5320 mA	6160 mA
Maximum Reverse Voltage ⁶	-90V	-120V	-65V

Notes for Table 6:

1. For IEC 62717 requirement, please consult your Bridgelux sales representative.
2. Refer to Bridgelux Application Note AN121: Assembly Considerations for Bridgelux Vero SE LED Arrays.
3. Arrays may be driven at higher currents however lumen maintenance may be reduced and warranty will not apply.
4. Bridgelux recommends a maximum duty cycle of 10% and pulse width of 20 ms when operating LED Arrays at maximum peak pulsed current specified. Maximum peak pulsed currents indicate values where LED Arrays can be driven without catastrophic failures.
5. Light emitting diodes are not designed to be driven in reverse voltage and will not produce light under this condition. Maximum rating provided for reference only.

Performance Curves

Figure 1: Vero SE 29B Drive Current vs. Voltage

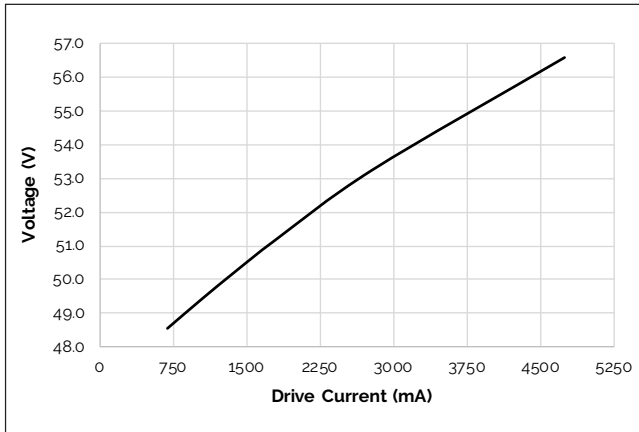

Figure 2: Vero SE 29C Drive Current vs. Voltage

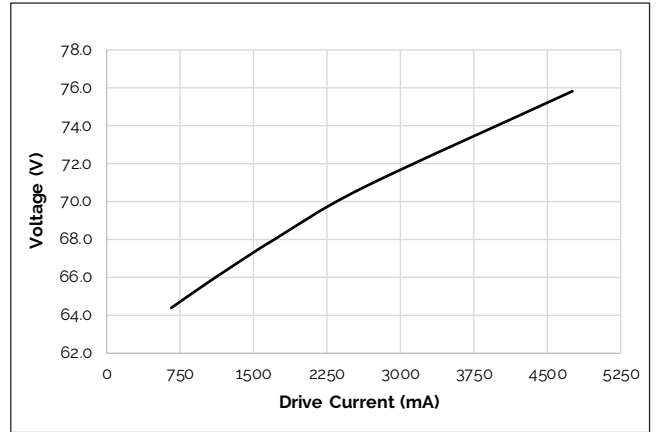

Figure 3: Vero SE 29D Drive Current vs. Voltage

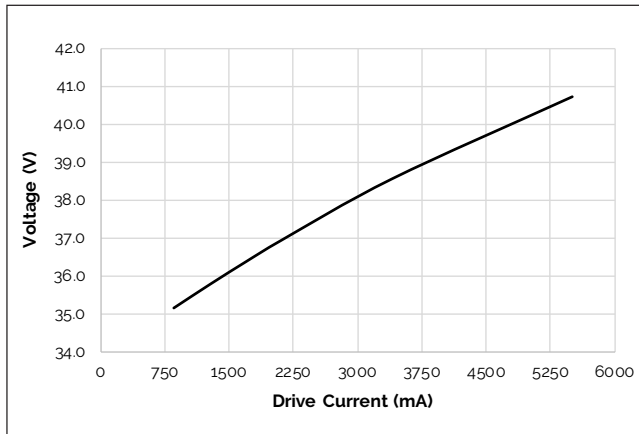

Figure 4: Vero SE 29B Typical Relative Flux vs. Current

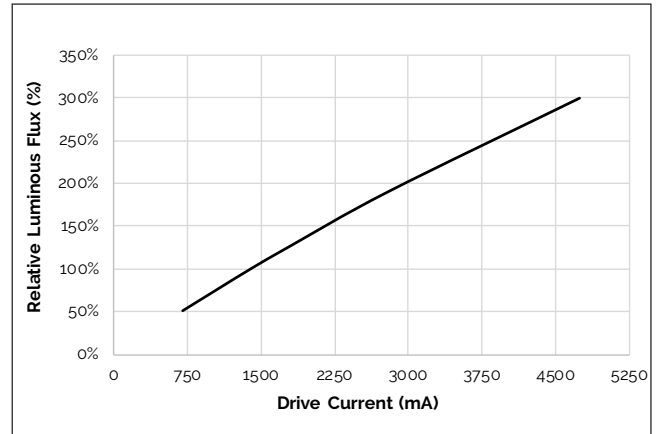

Figure 5: Vero SE 29C Typical Relative Flux vs. Current

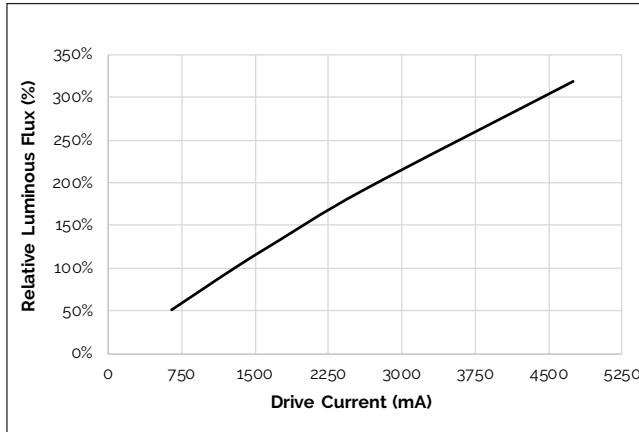
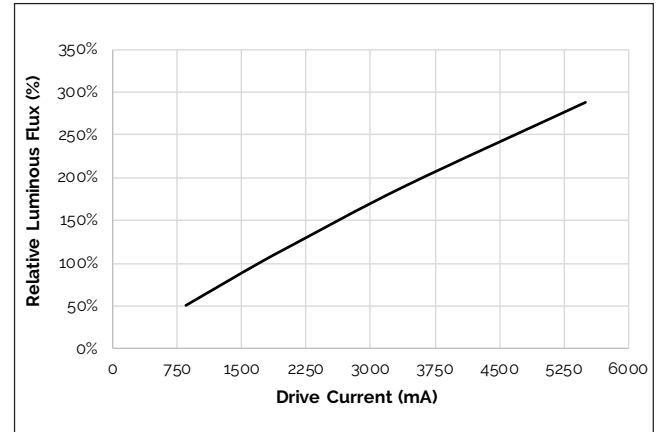

Figure 6: Vero SE 29D Typical Relative Flux vs. Current



Notes for Figures 1-6:

1. Bridgelux does not recommend driving high power LEDs at low currents. Doing so may produce unpredictable results. Pulse width modulation (PWM) is recommended for dimming effects.
2. Products tested under pulsed condition (10ms pulse width) at nominal test current where T_J (junction temperature) - T_C (case temperature) = 25°C.

Performance Curves

Figure 7: Typical DC Flux vs. Case Temperature

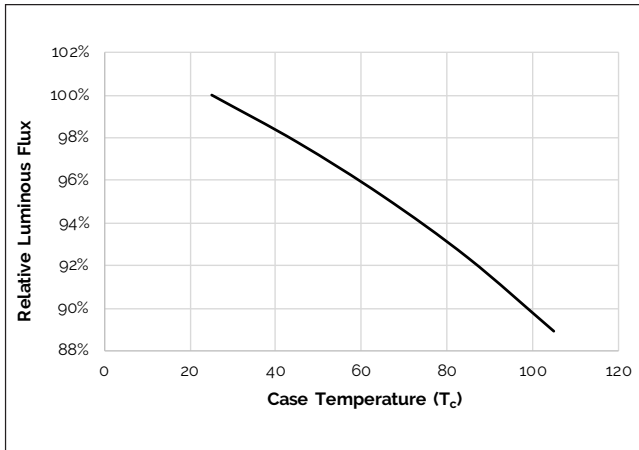

Figure 8: Typical DC ccy Shift vs. Case Temperature

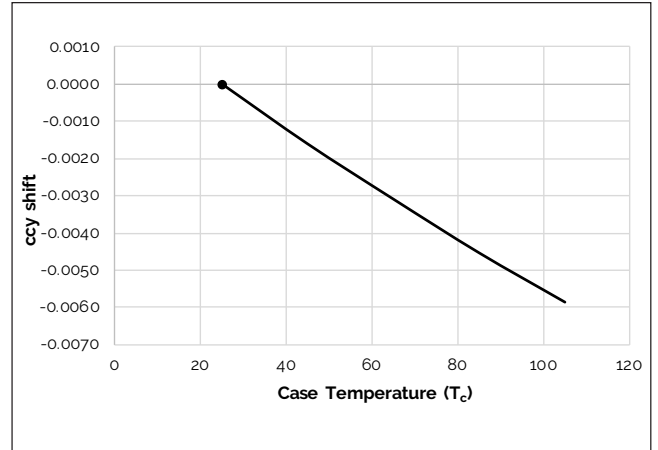

Figure 9: Typical DC ccx Shift vs. Case Temperature

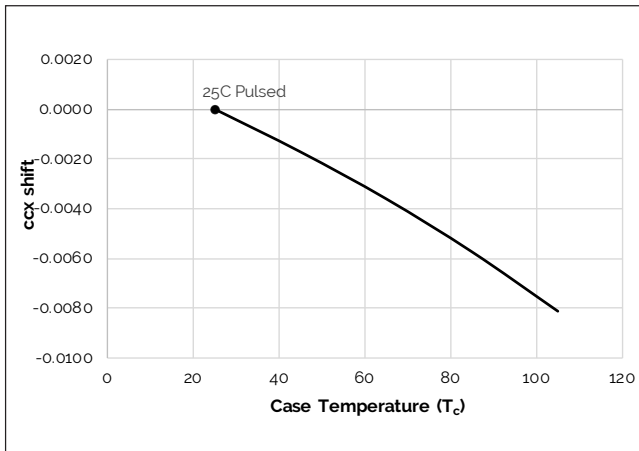
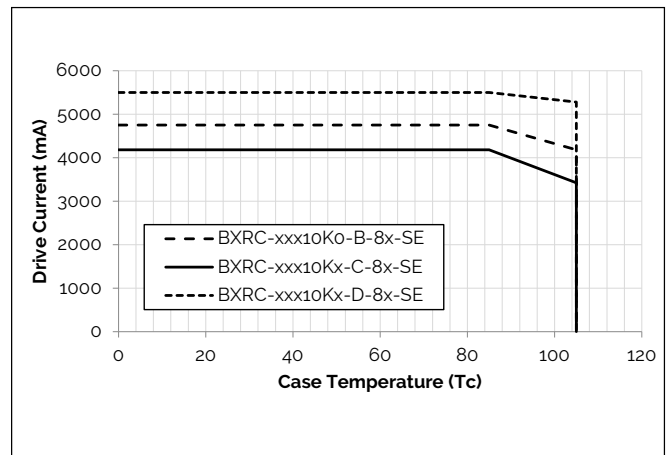
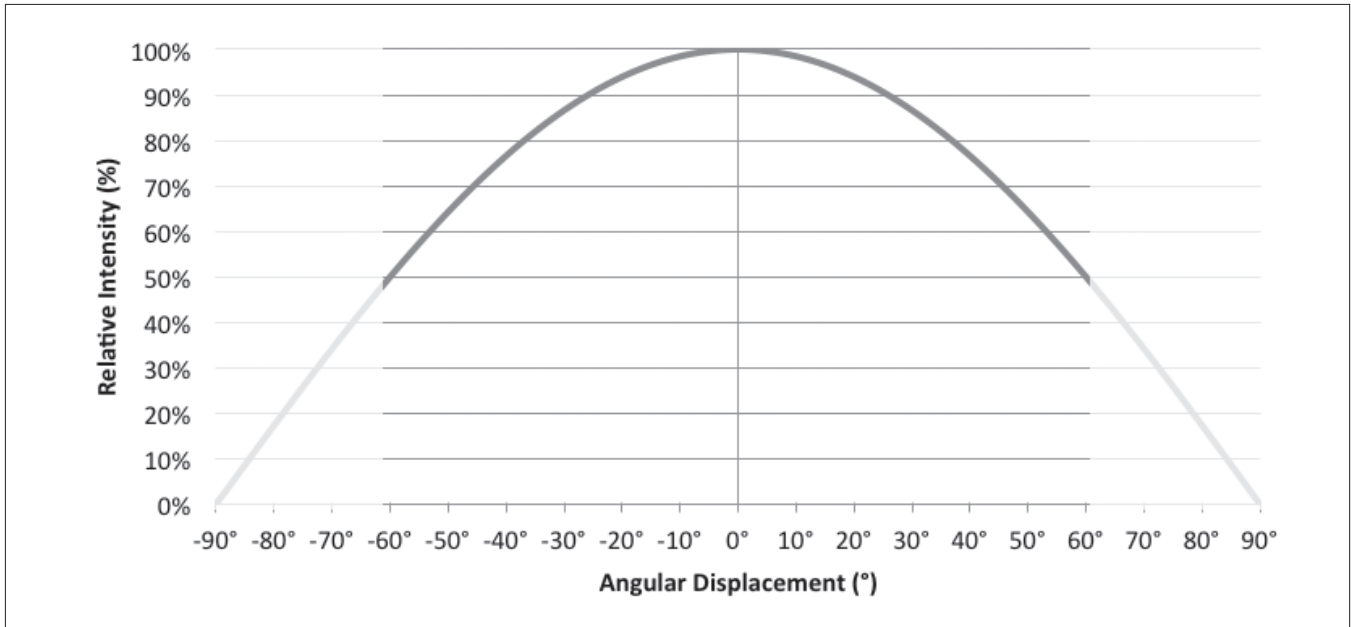

Figure 10: Derating Curve



Typical Radiation Pattern

Figure 11: Typical Spatial Radiation Pattern



Note for Figure 11:

1. Typical viewing angle is 120°.
2. The viewing angle is defined as the off axis angle from the centerline where intensity is ½ of the peak value.

Typical Radiation Pattern

Figure 12: Typical Polar Radiation Pattern

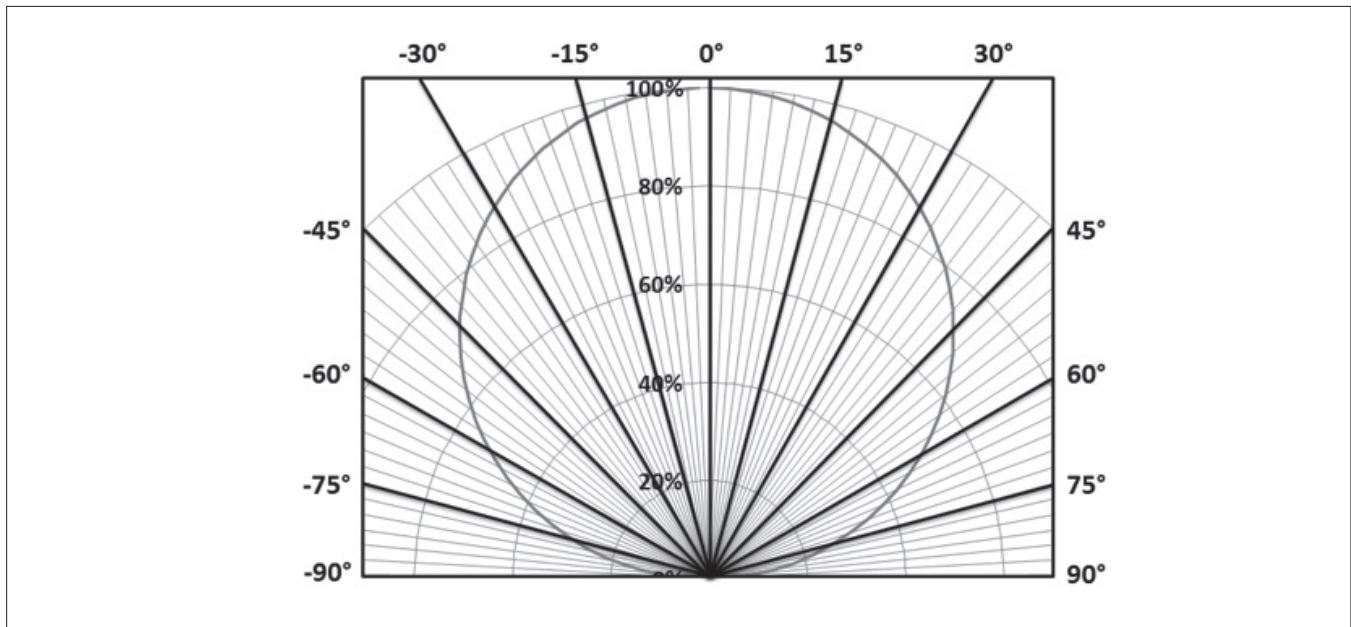

Typical Color Spectrum

Figure 13: Typical Color Spectrum

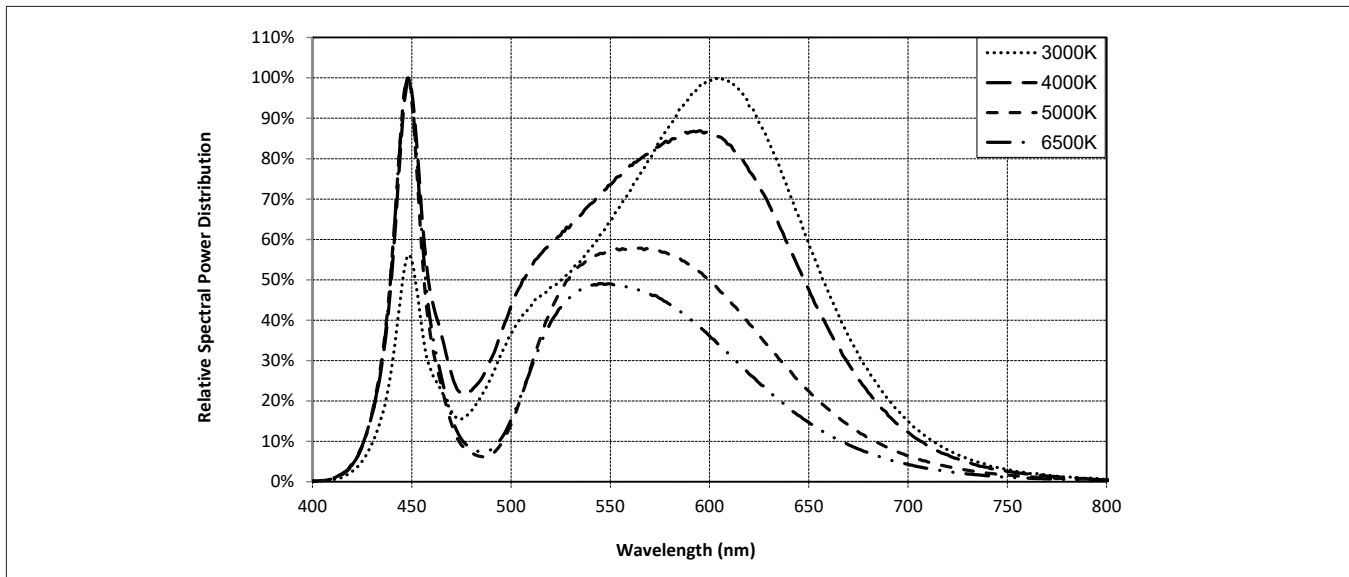

Note for Figure 13:

1. Color spectra measured at nominal current for $T_j = T_c = 25^\circ\text{C}$.
2. Color spectra shown is 3000K and 80 CRI.
3. Color spectra shown is 4000K and 80 CRI.
4. Color spectra shown is 5000K and 70 CRI.
4. Color spectra shown is 6500K and 70 CRI.

Mechanical Dimensions

Figure 14: Drawing for Vero SE 29 LED Array

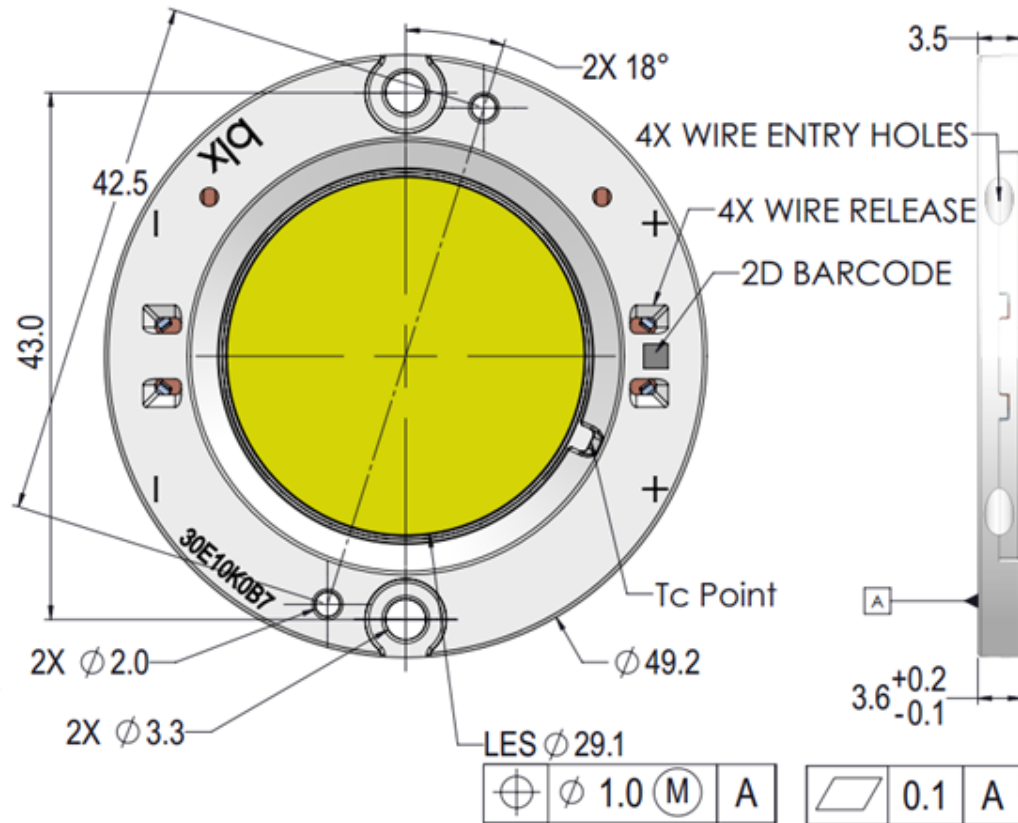

Notes for Figure 14:

1. Drawings are not to scale.
2. Drawing dimensions are in millimeters.
3. Unless otherwise specified, tolerances are ± 0.1 mm.
4. Mounting holes (2X) are for M3 screws.
5. Bridgelux recommends two tapped holes for mounting screws with 31.4 ± 0.10 mm center-to-center spacing.
6. Screws with flat shoulders (pan, dome, button, round, truss, mushroom) provide optimal torque control. Do NOT use flat, countersink, or raised head screws.
7. The optical center of the LED Array is nominally defined by the mechanical center of the array to a tolerance of ± 0.2 mm.
8. Bridgelux maintains a flatness of 0.10mm across the mounting surface of the array

Color Binning Information

Figure 15: Graph of Warm and Neutral White Test Bins in xy Color Space

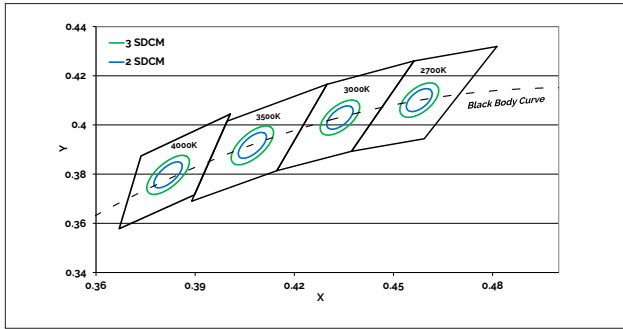

Note: Pulsed Test Conditions, $T_c = 25^\circ\text{C}$

Table 7: Warm and Neutral White xy Bin Coordinates and Associated Typical CCT

Bin Code	2700K	3000K	3500K	4000K
ANSI Bin (for reference only)	(2580K - 2870K)	(2870K - 3220K)	(3220K - 3710K)	(3710K - 4260K)
83 (3 SDCM)	(2651K - 2794K)	(2968K - 3136K)	(3369K - 3586K)	(3851K - 4130K)
82 (2 SDCM)	(2674K - 2769K)	(2995K - 3107K)	(3404K - 3548K)	(3895K - 4081K)
Center Point (x,y)	(0.4578, 0.4101)	(0.4338, 0.403)	(0.4073, 0.3917)	(0.3818, 0.3797)

Figure 16: Graph of Cool White Test Bins in xy Color Space

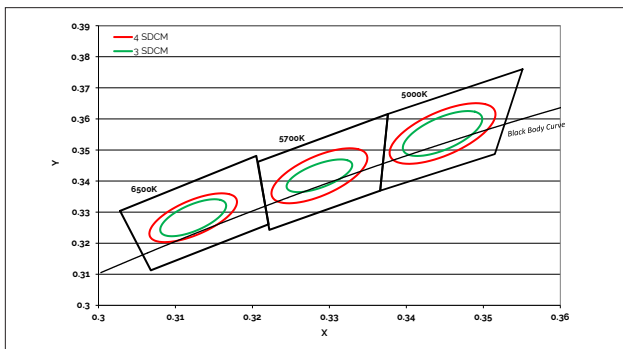

Note: Pulsed Test Conditions, $T_c = 25^\circ\text{C}$

Table 8: Cool White xy Bin Coordinates and Associated Typical CCT (product is hot targeted to $T_c = 85^\circ\text{C}$)

Bin Code	5000K	5700K	6500K
ANSI Bin (for reference only)	(4745K - 5311K)	(5312K - 6022K)	(6022K - 7042K)
84 (4 SDCM)	(4801K - 5282K)	(5829K - 5481K)	(6270K - 6765K)
83 (3 SDCM)	(4835K - 5215K)	(5490K - 5820K)	(6250K - 6745K)
Center Point (x,y)	(0.3447, 0.3553)	(0.3287, 0.3417)	(0.3123, 0.3282)

Packaging and Labeling

Figure 17: Drawing for Vero SE 29 Packaging Tray

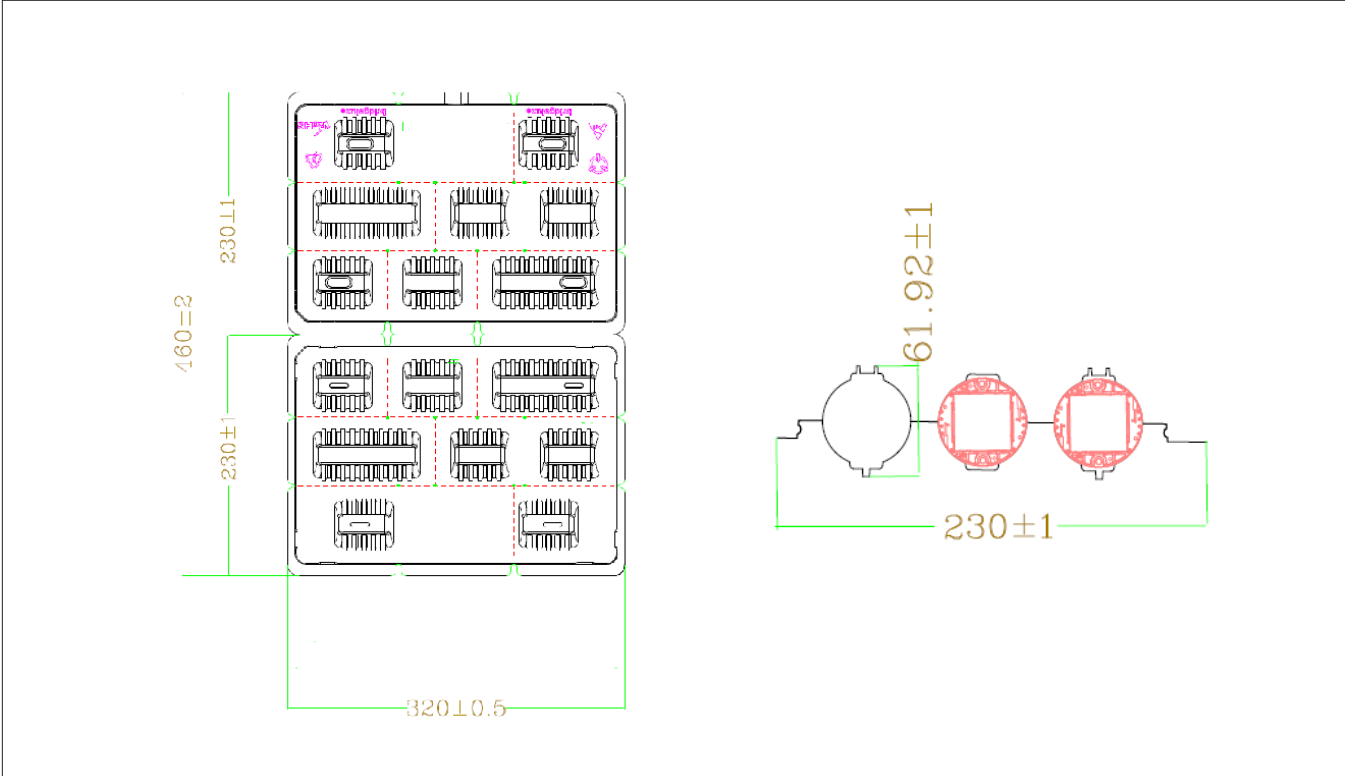

- Notes for Figure 17:
1. Dimensions are in millimeters.
 2. Drawings are not to scale.

Packaging and Labeling

Figure 18: Vero SE Series Packaging and Labeling

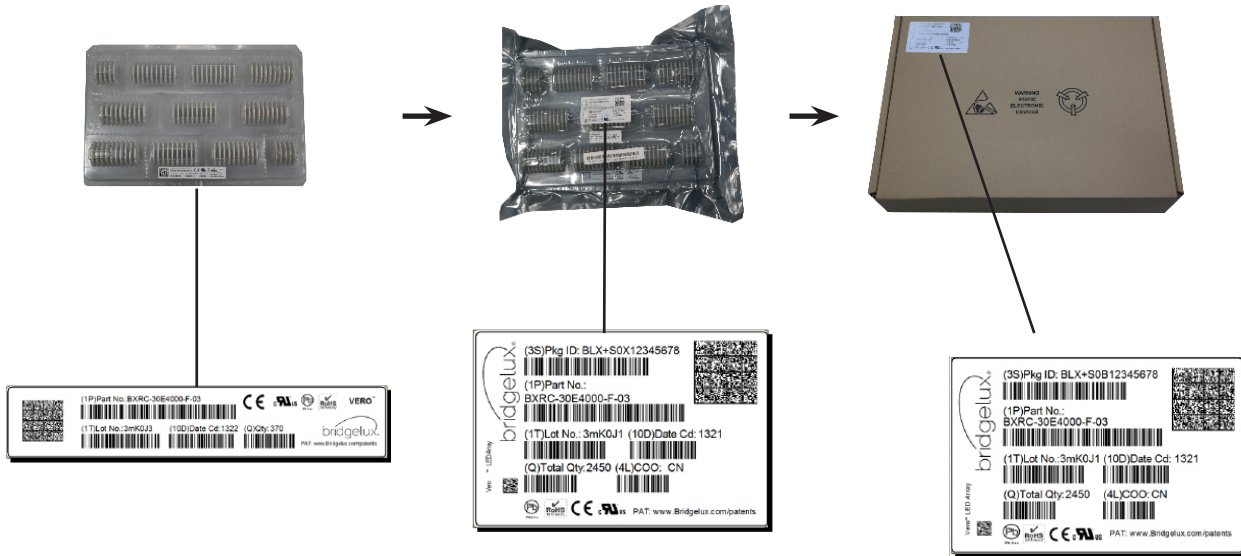

Notes for Figure 18:

1. Each tray holds 50 COBs.
2. Each tray is vacuum sealed in an anti-static bag and placed in its own box.
3. Each tray, bag and box is to be labeled as shown above.

Figure 19: Vero SE Product Labeling

Bridgelux COB arrays have laser markings on the back side of the substrate to help with product identification. In addition to the product identification markings, Bridgelux COB arrays also contain markings for internal Bridgelux manufacturing use only. The image below shows which markings are for customer use and which ones are for Bridgelux internal use only. The Bridgelux internal manufacturing markings are subject to change without notice, however these will not impact the form, function or performance of the COB array.



Customer Use- 2D Barcode
Scannable barcode provides product part number and other Bridgelux internal production information.

Customer Use- Product part number

30E10K0C 83 2F

Customer Use- V, Bin Code included to enable greater luminaire design flexibility. Refer to AN92 for bin definitions.

Design Resources

Application Notes

Bridgelux has developed a comprehensive set of application notes and design resources to assist customers in successfully designing with the Vero product family of LED array products. For all available application notes visit www.bridgelux.com.

Optical Source Models

Optical source models and ray set files are available for all Bridgelux products. For a list of available formats, visit www.bridgelux.com.

3D CAD Models

Three dimensional CAD models depicting the product outline of all Bridgelux Vero SE LED arrays are available in both IGS and STEP formats. Please contact your Bridgelux sales representative for assistance.

LM80

LM80 testing has been completed and the LM80 report is now available. Please contact your Bridgelux sales representative for LM-80 report.

Precautions

CAUTION: CHEMICAL EXPOSURE HAZARD

Exposure to some chemicals commonly used in luminaire manufacturing and assembly can cause damage to the LED array. Please consult Bridgelux Application Note AN120 for additional information.

CAUTION: RISK OF BURN

Do not touch the Vero LED array during operation. Allow the array to cool for a sufficient period of time before handling. The Vero LED array may reach elevated temperatures such that could burn skin when touched.

CAUTION

CONTACT WITH LIGHT EMITTING SURFACE (LES)

Avoid any contact with the LES. Do not touch the LES of the LED array or apply stress to the LES (yellow phosphor resin area). Contact may cause damage to the LED array.

Optics and reflectors must not be mounted in contact with the LES (yellow phosphor resin area). Optical devices may be mounted on the top surface of the plastic housing of the Vero LED array. Use the mechanical features of the LED array housing, edges and/or mounting holes to locate and secure optical devices as needed.

Disclaimers

MINOR PRODUCT CHANGE POLICY

The rigorous qualification testing on products offered by Bridgelux provides performance assurance. Slight cosmetic changes that do not affect form, fit, or function may occur as Bridgelux continues product optimization.

STANDARD TEST CONDITIONS

Unless otherwise stated, array testing is performed at the nominal drive current.

About Bridgelux: Bridging Light and Life™

At Bridgelux, we help companies, industries and people experience the power and possibility of light. Since 2002, we've designed LED solutions that are high performing, energy efficient, cost effective and easy to integrate. Our focus is on light's impact on human behavior, delivering products that create better environments, experiences and returns—both experiential and financial. And our patented technology drives new platforms for commercial and industrial luminaires.

For more information about the company, please visit
bridgelux.com
twitter.com/Bridgelux
facebook.com/Bridgelux
youtube.com/user/Bridgelux
linkedin.com/company/bridgelux-inc-_2
WeChat ID: BridgeluxInChina



46430 Fremont Boulevard
Fremont, CA 94538 U.S.A.
Tel (925) 583-8400
www.bridgelux.com

© 2020 Bridgelux, Inc. All rights reserved. Product specifications are subject to change without notice. Bridgelux, the Bridgelux stylized logo design, Vero, V Series and V Series HD are registered trademarks, and Decor Series is a trademark of Bridgelux, Inc. All other trademarks are the property of their respective owners.

Bridgelux Gen 8 Vero SE 29 Array Series Product Data Sheet DS433 Rev. A (06/2020)

单击下面可查看定价，库存，交付和生命周期等信息

[>>Bridgelux\(普瑞光电\)](#)