

Bridgelux® V10 Array

Product Data Sheet DS42



BXRE-27X1000

30X1000

35X1000

40X1000

50X1000

Introduction

V Series

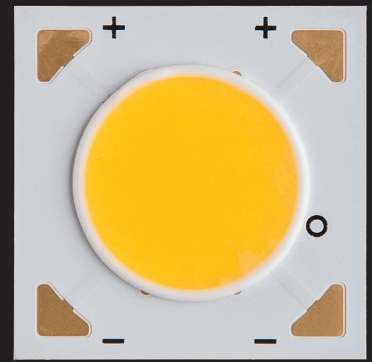

The V Series™ LED Array products deliver high quality light in a compact and cost-effective solid-state lighting package. These Chip-on-Board (CoB) arrays can be efficiently driven at twice the nominal drive current, enabling design flexibility not previously possible. This high flux density light source is designed to support a wide range of high quality, low cost directional luminaires and replacement lamps for commercial and residential applications.

The V10 LED Array is available in a variety of electrical, CCT and CRI combinations providing substantial design flexibility and energy efficiencies.

Lighting system designs incorporating these LED Arrays deliver comparable performance to 26 Watt compact fluorescent and 150 Watt incandescent and halogen based luminaires, delivering increased system level efficacy and longer service life. Typical applications include, but are not limited to, replacement lamps, task, accent, spot, track, down light, wide area, security, and wall pack.

Features

- Efficacy of 130 lm/W typical
- Compact high flux density light source
- Uniform high quality illumination
- Minimum 70, 80 and 90 CRI options
- Streamlined thermal path
- Energy Star / ANSI compliant color binning structure with 3SDCM and 4SDCM options
- More energy efficient than incandescent, halogen and fluorescent lamps
- Low voltage DC operation
- Instant light with unlimited dimming

Benefits

- Enhanced optical control
- Clean white light without pixilation
- High quality true color reproduction
- Significantly reduced thermal resistance and increased operating temperatures
- Uniform consistent white light
- Lower operating costs
- Easy to use with daylight and motion detectors to enable increased energy savings
- Reduced maintenance costs
- Environmentally friendly, no disposal issue



Contents

Product Feature Map	2
Product Nomenclature	2
Product Selection Guide	3
Performance at Commonly Used Drive Currents	4
Flux & Electrical Characteristics	6
Absolute Maximum Ratings	7
Performance Curves	8
Typical Radiation Pattern	12
Typical Color Spectrum	13
Mechanical Dimensions	14
Color Binning Information	15
Packaging and Labeling	16
Design Resources	18
Precautions	18
Disclaimers	18
About Bridgelux	19

Product Selection Guide

The following product configurations are available:

Table 1: Selection Guide, Pulsed Measurement Data ($T_j = T_c = 25^\circ\text{C}$)

Part Number	Nominal CCT ¹ (K)	CRI ²	Nominal Drive Current ³ (mA)	Typical Pulsed Flux ^{4,5,6} $T_c = 25^\circ\text{C}$ (lm)	Minimum Pulsed Flux ^{6,7} $T_c = 25^\circ\text{C}$ (lm)	Typical V_f (V)	Typical Power (W)	Typical Efficacy (lm/W)
BXRE-27E1000-B-2x	2700	80	350	1150	1091	26.5	9.3	124
BXRE-27G1000-B-2x	2700	90	350	956	881	26.5	9.3	103
BXRE-30E1000-B-2x	3000	80	350	1213	1125	26.5	9.3	131
BXRE-30G1000-B-2x	3000	90	350	1003	910	26.5	9.3	108
BXRE-35E1000-B-2x	3500	80	350	1234	1200	26.5	9.3	133
BXRE-35G1000-B-2x	3500	90	350	1068	1041	26.5	9.3	115
BXRE-40E1000-B-2x	4000	80	350	1253	1186	26.5	9.3	135
BXRE-40G1000-B-2x	4000	90	350	1076	989	26.5	9.3	116
BXRE-50C1000-B-24	5000	70	350	1330	1230	26.5	9.3	143
BXRE-50E1000-B-24	5000	80	350	1263	1192	26.5	9.3	136
BXRE-50G1000-B-24	5000	90	350	1106	1010	26.5	9.3	119

Table 2: Selection Guide, Stabilized DC Performance ($T_c = 85^\circ\text{C}$)^{8,9}

Part Number	Nominal CCT ¹ (K)	CRI ²	Nominal Drive Current ³ (mA)	Typical DC Flux $T_c = 85^\circ\text{C}$ (lm)	Minimum DC Flux ¹⁰ $T_c = 85^\circ\text{C}$ (lm)	Typical V_f (V)	Typical Power (W)	Typical Efficacy (lm/W)
BXRE-27E1000-B-2x	2700	80	350	1022	970	25.7	9.0	114
BXRE-27G1000-B-2x	2700	90	350	850	783	25.7	9.0	95
BXRE-30E1000-B-2x	3000	80	350	1086	1008	25.7	9.0	121
BXRE-30G1000-B-2x	3000	90	350	898	815	25.7	9.0	100
BXRE-35E1000-B-2x	3500	80	350	1105	1075	25.7	9.0	123
BXRE-35G1000-B-2x	3500	90	350	957	932	25.7	9.0	107
BXRE-40E1000-B-2x	4000	80	350	1123	1063	25.7	9.0	125
BXRE-40G1000-B-2x	4000	90	350	964	886	25.7	9.0	107
BXRE-50C1000-B-24	5000	70	350	1154	1067	25.7	9.0	128
BXRE-50E1000-B-24	5000	80	350	1095	1034	25.7	9.0	122
BXRE-50G1000-B-24	5000	80	350	959	876	25.7	9.0	107

Notes for Tables 1 & 2:

- Nominal CCT as defined by ANSI C78.377-2011.
- CRI Values are minimums. Minimum Rg value for 80 CRI products is 0, the minimum Rg values for 90 CRI products is 50.
- Drive current is referred to as nominal drive current.
- Products tested under pulsed condition (10ms pulse width) at nominal test current where T_j (junction temperature) - T_c (case temperature) = 25°C .
- Typical performance values are provided as a reference only and are not a guarantee of performance.
- Bridgelux maintains a $\pm 7\%$ tolerance on flux measurements.
- Minimum flux values at nominal test current are guaranteed by 100% test.
- Typical stabilized DC performance values are provided as reference only and are not a guarantee of performance.
- Typical performance is estimated based on operation under DC (direct current) with LED array mounted onto a heat sink with thermal interface material and the case temperature maintained at 85°C . Based on Bridgelux test setup, values may vary depending on the thermal design of the luminaire and/or the exposed environment to which the product is subjected.
- Minimum flux values at elevated temperatures are provided for reference only and are not guaranteed by 100% production testing. Based on Bridgelux test setup, values may vary depending on the thermal design of the luminaire and/or the exposed environment to which the product is subjected.

Performance at Commonly Used Drive Currents

V Series LED arrays are tested to the specifications shown using the nominal drive currents in Table 1. V Series may also be driven at other drive currents dependent on specific application design requirements. The performance at any drive current can be derived from the current vs. voltage characteristics shown in Figure 2 and the flux vs. current characteristics shown in Figure 3. The performance at commonly used drive currents is summarized in Table 3.

Table 3: Product Performance at Commonly Used Drive Currents

Part Number	CRI	Drive Current ¹ (mA)	Typical V_f $T_c = 25^\circ\text{C}$ (V)	Typical Power $T_c = 25^\circ\text{C}$ (W)	Typical Flux ² $T_c = 25^\circ\text{C}$ (lm)	Typical DC Flux ³ $T_c = 85^\circ\text{C}$ (lm)	Typical Efficacy $T_c = 25^\circ\text{C}$ (lm/W)
BXRE-27E1000-B-2x	80	175	24.9	4.4	606	538	139
		350	26.5	9.3	1150	1022	124
		500	27.6	13.8	1577	1402	114
		700	29.0	20.3	2075	1844	102
BXRE-27G1000-B-2x	90	175	24.9	4.4	504	448	116
		350	26.5	9.3	956	850	103
		500	27.6	13.8	1311	1165	95
		700	29.0	20.3	1725	1533	85
BXRE-30E1000-B-2x	80	175	24.9	4.4	639	572	147
		350	26.5	9.3	1213	1086	131
		500	27.6	13.8	1663	1490	121
		700	29.0	20.3	2189	1960	108
BXRE-30G1000-B-2x	90	175	24.9	4.4	528	473	121
		350	26.5	9.3	1003	898	108
		500	27.6	13.8	1375	1232	100
		700	29.0	20.3	1810	1621	89
BXRE-35E1000-B-2x	80	175	24.9	4.4	650	582	149
		350	26.5	9.3	1234	1105	133
		500	27.6	13.8	1692	1516	123
		700	29.0	20.3	2227	1994	110
BXRE-35G1000-B-2x	90	175	24.9	4.4	563	504	129
		350	26.5	9.3	1068	957	115
		500	27.6	13.8	1465	1312	106
		700	29.0	20.3	1927	1726	95
BXRE-40E1000-B-2x	80	175	24.9	4.4	660	591	151
		350	26.5	9.3	1253	1123	135
		500	27.6	13.8	1718	1540	125
		700	29.0	20.3	2261	2026	111

Notes for Table 3:

1. Alternate drive currents in Table 3 are provided for reference only and are not a guarantee of performance.
2. Bridgelux maintains a $\pm 7\%$ tolerance on flux measurements.
3. Typical stabilized DC performance values are provided as reference only and are not a guarantee of performance.

Performance at Commonly Used Drive Currents

Table 3: Product Performance at Commonly Used Drive Currents (Continued)

Part Number	CRI	Drive Current ¹ (mA)	Typical V_f $T_c = 25^\circ\text{C}$ (V)	Typical Power $T_c = 25^\circ\text{C}$ (W)	Typical Flux ² $T_c = 25^\circ\text{C}$ (lm)	Typical DC Flux ³ $T_c = 85^\circ\text{C}$ (lm)	Typical Efficacy $T_c = 25^\circ\text{C}$ (lm/W)
BXRE-40G1000-B-2x	90	175	24.9	4.4	567	508	130
		350	26.5	9.3	1076	964	116
		500	27.6	13.8	1476	1322	107
		700	29.0	20.3	1942	1740	96
BXRE-50C1000-B-24	70	175	24.9	4.4	701	608	161
		350	26.5	9.3	1330	1154	143
		500	27.6	13.8	1824	1582	132
		700	29.0	20.3	2400	2082	118
BXRE-50E1000-B-24	80	175	24.9	4.4	665	577	153
		350	26.5	9.3	1263	1095	136
		500	27.6	13.8	1732	1502	126
		700	29.0	20.3	2279	1977	112
BXRE-50G1000-B-24	90	175	24.9	4.4	583	505	134
		350	26.5	9.3	1106	959	119
		500	27.6	13.8	1517	1315	110
		700	29.0	20.3	1996	1731	98

Notes for Table 3:

1. Alternate drive currents in Table 3 are provided for reference only and are not a guarantee of performance.
2. Bridgelux maintains a $\pm 7\%$ tolerance on flux measurements.
3. Typical stabilized DC performance values are provided as reference only and are not a guarantee of performance.

Electrical Characteristics

Table 4: Electrical Characteristics

Part Number	Drive Current (mA)	Forward Voltage Pulsed, $T_c = 25^\circ\text{C}$ (V) ^{1, 2, 3}			Typical Coefficient of Forward Voltage ⁴ $\Delta V_f / \Delta T_c$ (mV/ $^\circ\text{C}$)	Typical Thermal Resistance Junction to Case ^{5, 6} R_{j-c} ($^\circ\text{C}/\text{W}$)	Driver Selection Voltages ⁷ (V)	
		Minimum	Typical	Maximum			V_f Min. Hot $T_c = 105^\circ\text{C}$ (V)	V_f Max. Cold $T_c = -40^\circ\text{C}$ (V)
BXRE-xxx1000-B-2x	350	24.5	26.5	28.5	-14	0.47	23.4	29.4
	700	26.5	29.0	31.2	-14	0.59	25.4	32.1

Notes for Table 4:

1. Parts are tested in pulsed conditions, $T_c = 25^\circ\text{C}$. Pulse width is 10ms.
2. Voltage minimum and maximum are provided for reference only and are not a guarantee of performance.
3. Bridgelux maintains a tester tolerance of $\pm 0.10\text{V}$ on forward voltage measurements.
4. Typical coefficient of forward voltage tolerance is $\pm 0.1\text{mV}$ for nominal current.
5. Thermal resistance values are based from test data of a 3000K 80 CRI product.
6. Thermal resistance value was calculated using total electrical input power; optical power was not subtracted from input power. The thermal interface material used during testing is not included in the thermal resistance value.
7. V_f min hot and max cold values are provided as reference only and are not guaranteed by test. These values are provided to aid in driver design and selection over the operating range of the product.

Absolute Maximum Ratings

Table 5: Maximum Ratings

Parameter	Maximum Rating
LED Junction Temperature (T_j)	150°C
Storage Temperature	-40°C to +105°C
Operating Case Temperature ¹ (T_c)	105°C
Soldering Temperature ²	350°C or lower for a maximum of 10 seconds
Maximum Drive Current ³	700mA
Maximum Peak Pulsed Drive Current ⁴	1000mA
Maximum Reverse Voltage ⁵	-45V

Notes for Table 5:

1. Please refer to Figure 1 for drive current derating. For IEC 62717 requirement, please contact Bridgelux Sales Support.
2. See Bridgelux Application Note AN31, Assembly Considerations for Vero LED arrays, for more information.
3. Please refer to Figure 1 for drive current derating curve.
4. Bridgelux recommends a maximum duty cycle of 10% and pulse width of 20ms when operating LED Arrays at the maximum peak pulsed current specified. Maximum peak pulsed currents indicate values where the LED array can be driven without catastrophic failures.
5. Light emitting diodes are not designed to be driven in reverse voltage and will not produce light under this condition. Maximum rating provided for reference only.

Performance Curves

The maximum allowable drive current for the V10 product family is dependent on the operating case temperature. Please refer to the Product Feature Map (page 2) for the location of the T_c Point.

Figure 1: V10 Drive Current Derating Curve

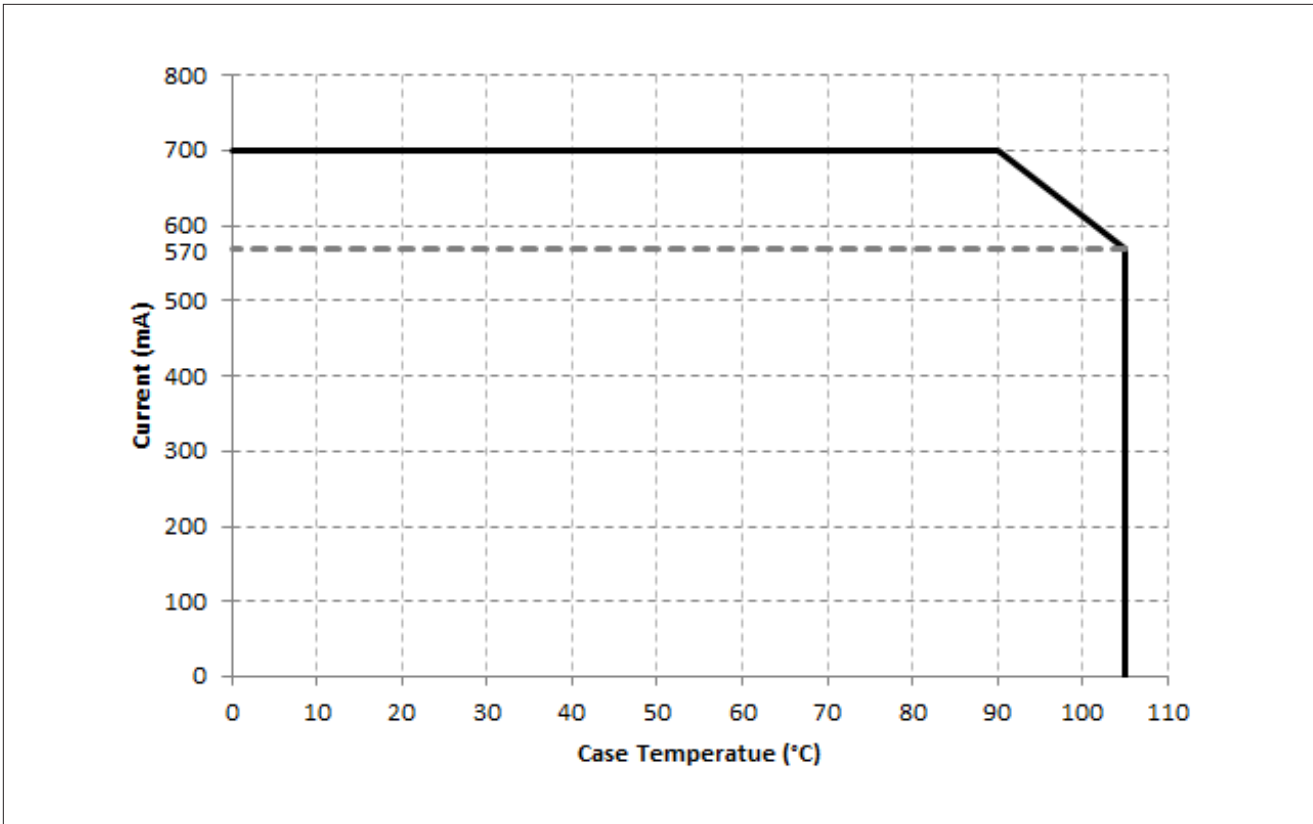

Notes for Figure 1:

1. In order to meet LM-80 lifetime projections V10 may be driven up to 700mA at case temperatures up to 90°C. Operating conditions above case temperatures of 90°C driving conditions must follow the V10 Drive Current Derating Curve.
2. Lumen maintenance (L70) and lifetime predictions are valid for drive current and case temperature conditions used for LM-80 testing as included in the applicable LM-80 test report for these products. Contact your Bridgelux sales representative for LM-80 report.

Performance Curves

Figure 2: Drive Current vs. Voltage ($T_j = T_c = 25^\circ\text{C}$)

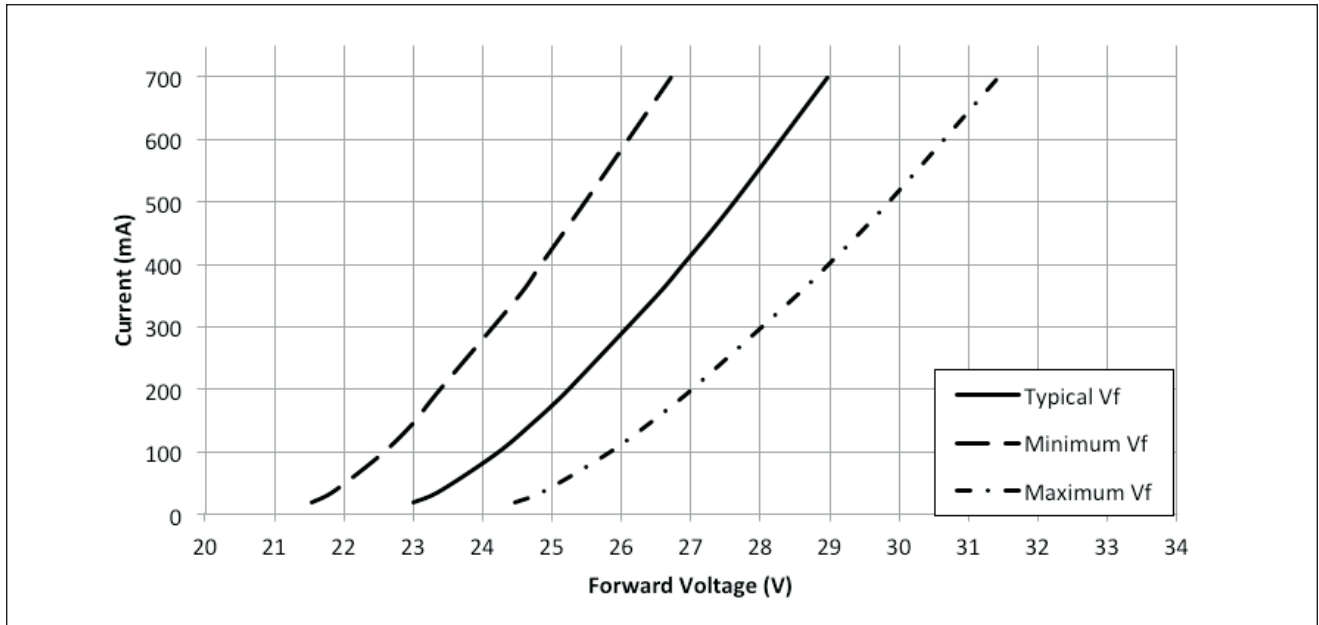
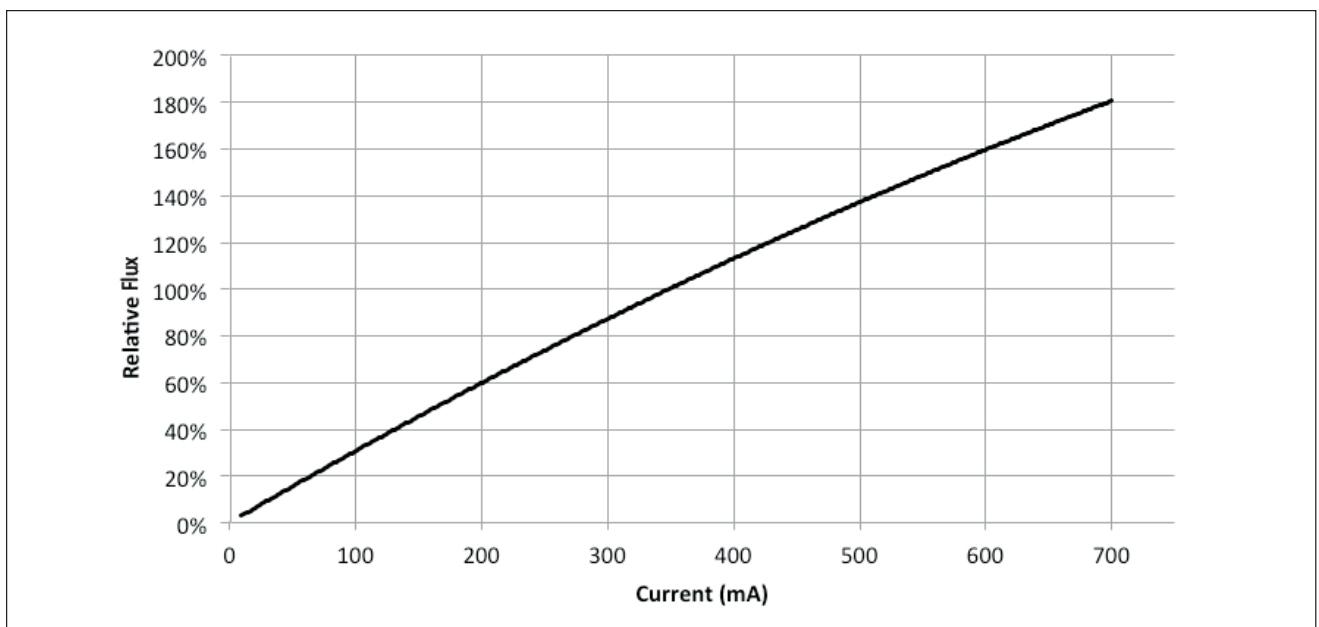

Figure 3: Typical Relative Luminous Flux vs. Current ($T_j = T_c = 25^\circ\text{C}$)



Note for Figure 3:

1. Bridgelux does not recommend driving high power LEDs at low currents. Doing so may produce unpredictable results. Pulse width modulation (PWM) is recommended for dimming effects.

Performance Curves

Figure 4: Typical DC Flux vs. Case Temperature

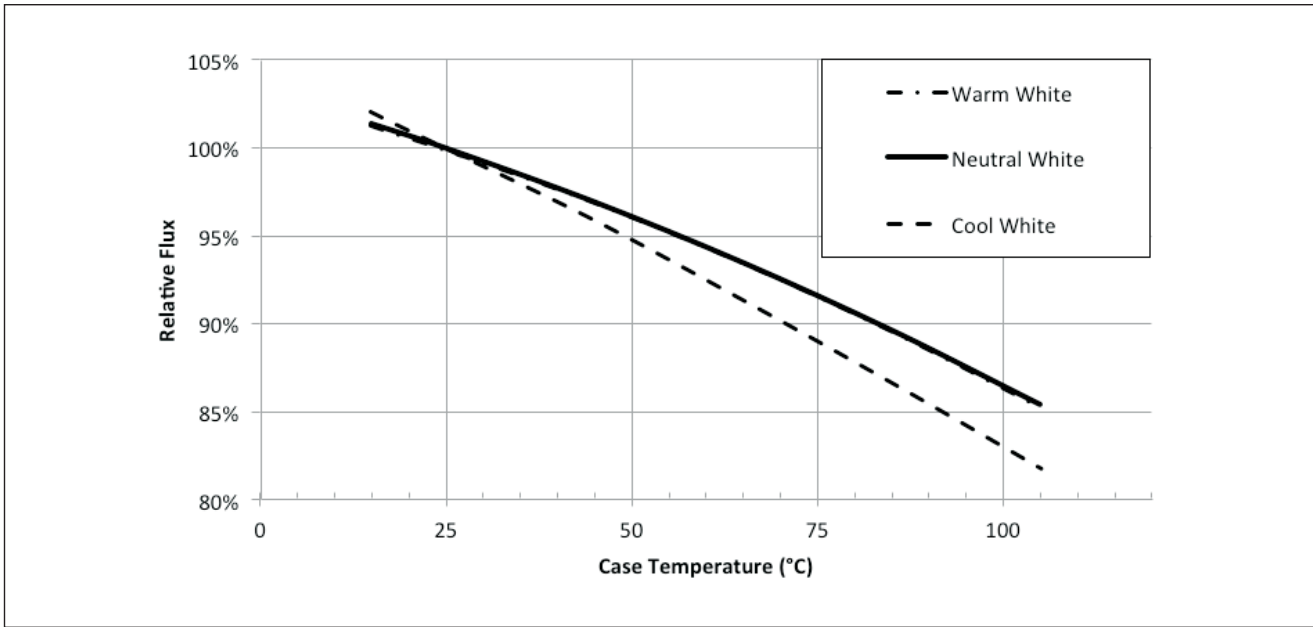
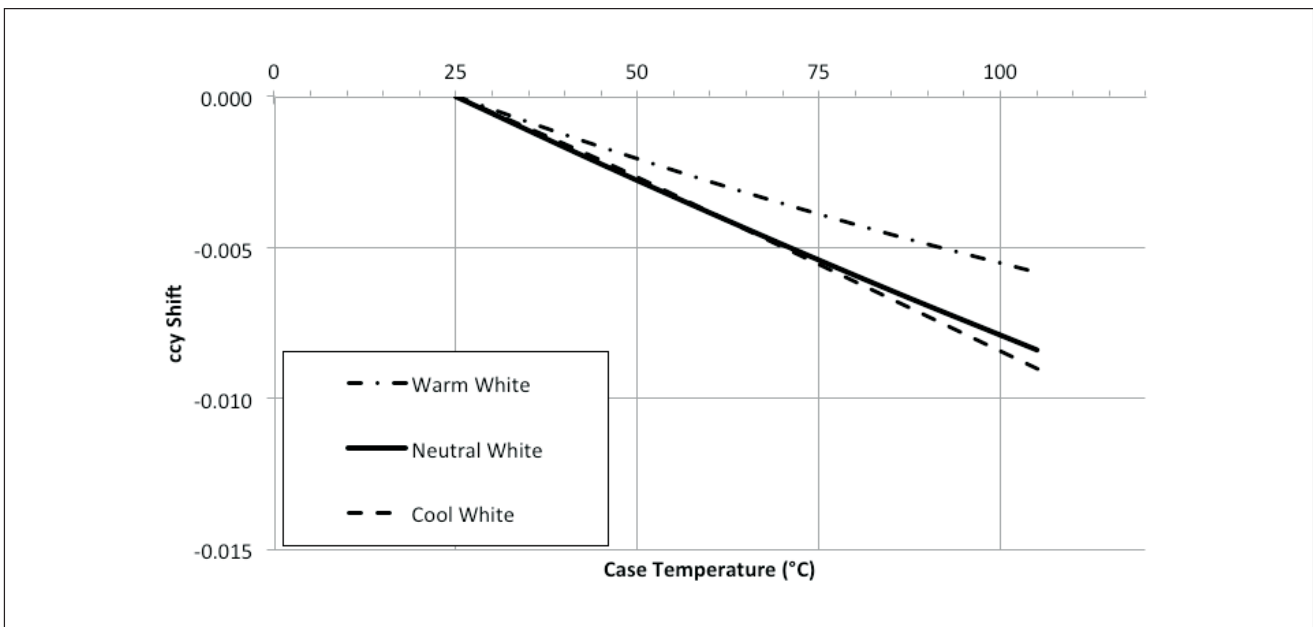

Figure 5: Typical DC ccy Shift vs. Case Temperature



Notes for Figures 4-5:

1. Characteristics shown for warm white based on 3000K and 80 CRI.
2. Characteristics shown for neutral white based on 4000K and 80 CRI.
3. Characteristics shown for cool white based on 5000K and 70 CRI.
4. For other color SKUs, the shift in color will vary. Please contact your Bridgelux Sales Representative for more information.

Performance Curves

Figure 6: Typical DC ccx Shift vs. Case Temperature

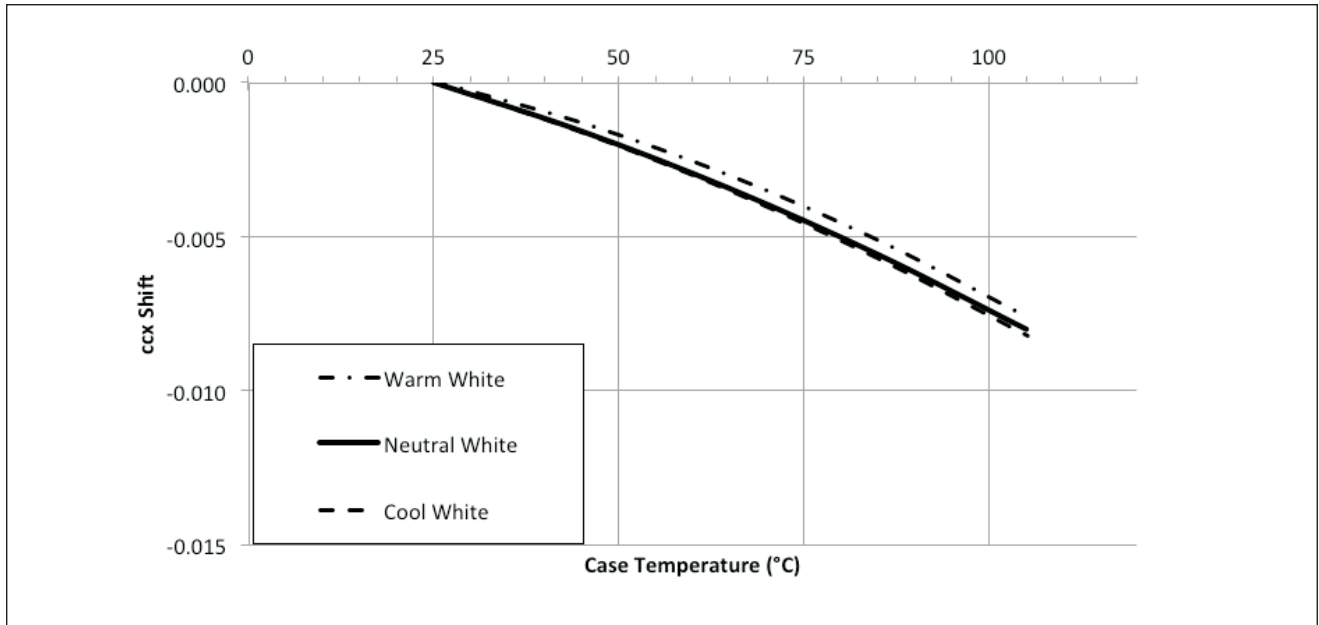

Notes for Figure 6:

1. Characteristics shown for warm white based on 3000K and 80 CRI.
2. Characteristics shown for neutral white based on 4000K and 80 CRI.
3. Characteristics shown for cool white based on 5000K and 70 CRI.
4. For other color SKUs, the shift in color will vary. Please contact your Bridgelux Sales Representative for more information.

Typical Radiation Pattern

Figure 7: Typical Spatial Radiation Pattern

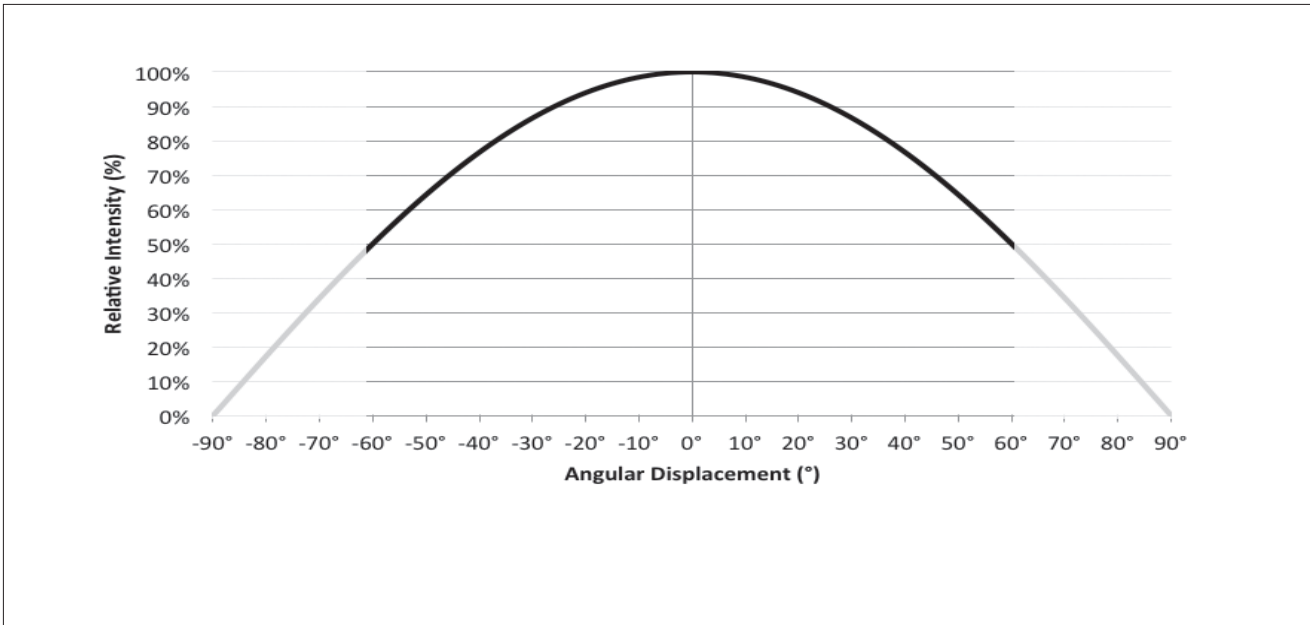

Note for Figure 7:

1. Typical viewing angle is 120°.
2. The viewing angle is defined as the off axis angle from the centerline where I_v is $\frac{1}{2}$ of the peak value.

Figure 8: Typical Polar Radiation Pattern

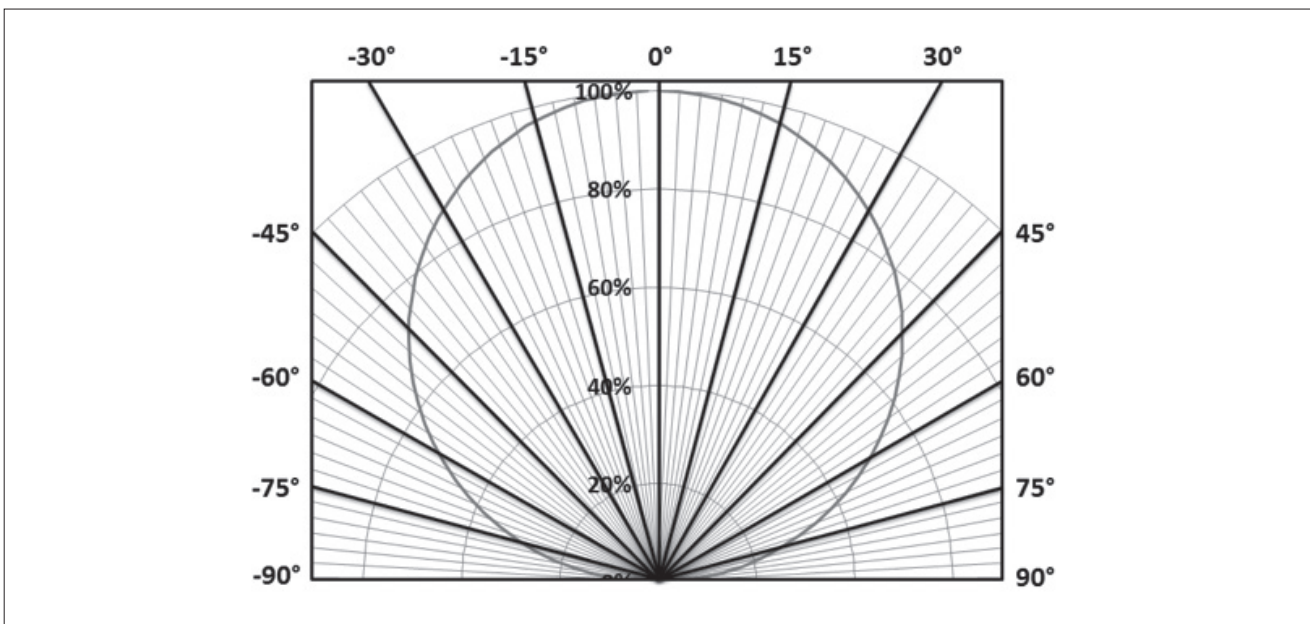

Typical Color Spectrum

Figure 9: Typical Color Spectrum

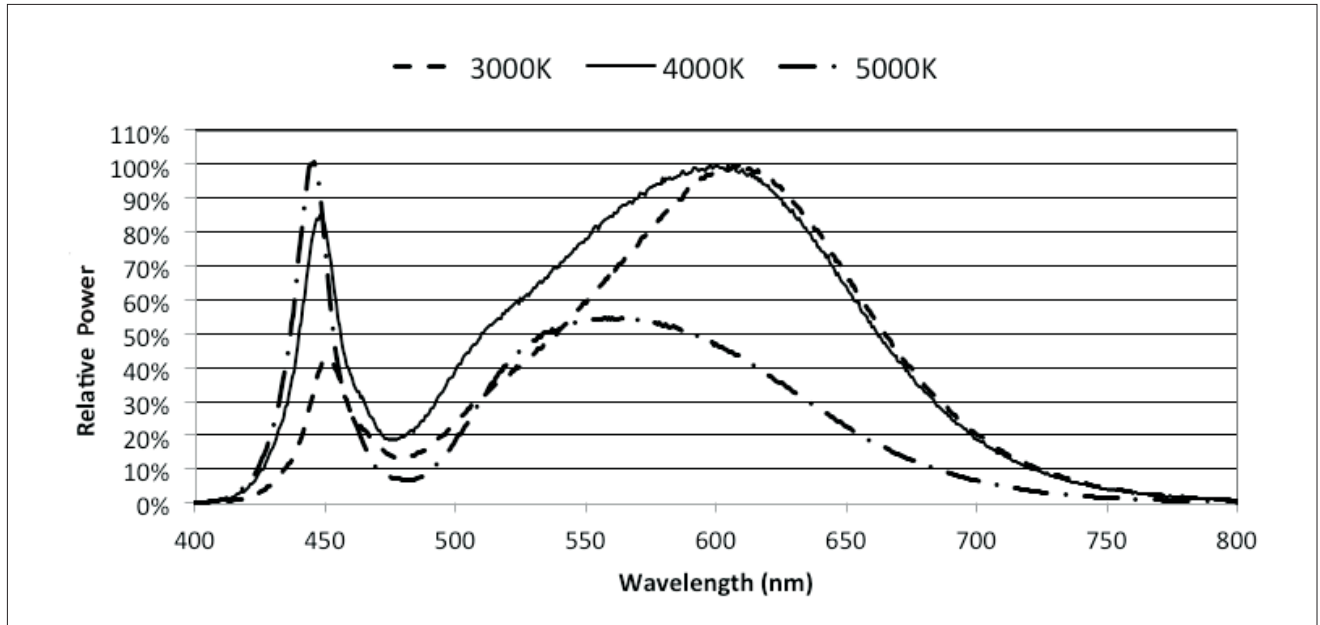

Note for Figure 9:

1. Color spectra measured at nominal current for $T_j = T_c = 25^\circ\text{C}$.
2. Color spectra shown for warm white is 3000K and 80 CRI.
3. Color spectra shown for neutral white is 4000K and 80 CRI.
4. Color spectra shown for cool white is 5000K and 70 CRI.

Mechanical Dimensions

Figure 10: Drawing for V10 LED Array

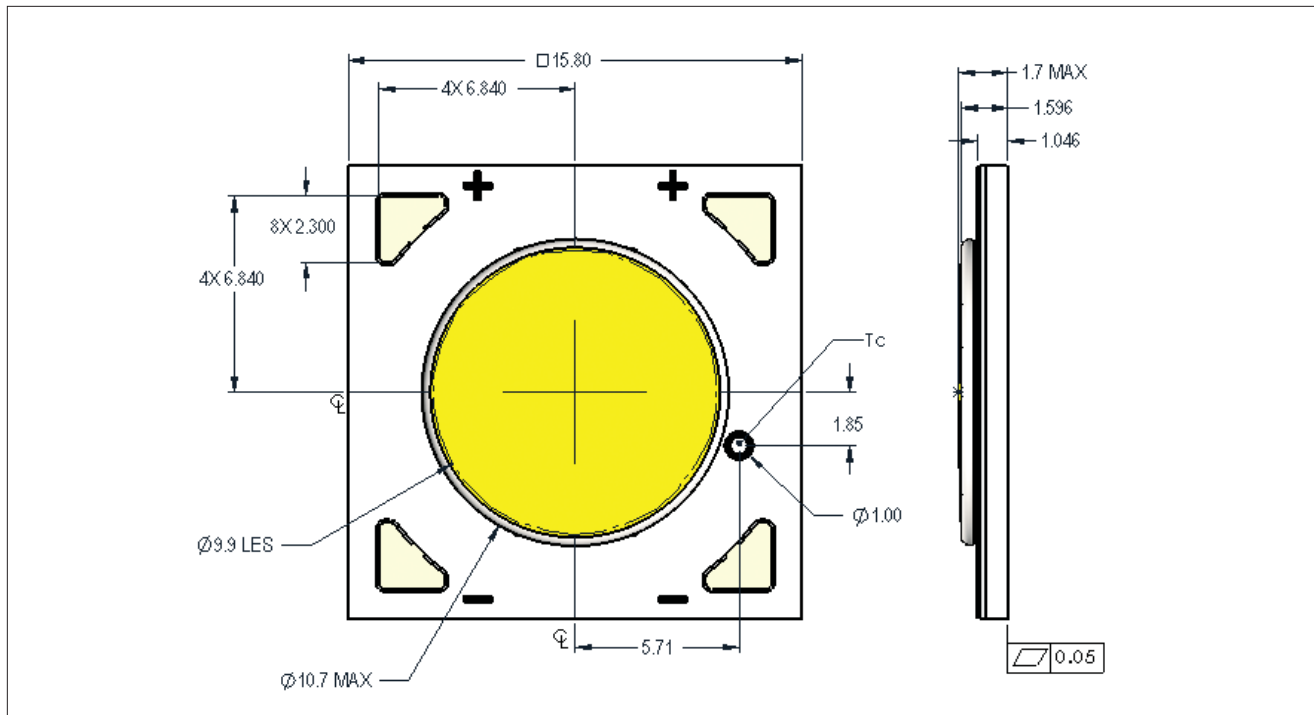

Notes for Figure 10:

1. Solder pads are labeled "+" and "-" to denote positive and negative polarity, respectively.
2. It is not necessary to provide electrical connections to both sets of solder pads. Either set may be used depending on application specific design requirements.
3. Drawings are not to scale.
4. Drawing dimensions are in millimeters.
5. Unless otherwise specified, tolerances are ± 0.10 mm.
6. The optical center of the LED Array is nominally defined by the mechanical center of the array. The light emitting surface (LES) is centered on the mechanical center of the array to a tolerance of ± 0.2 mm
7. Bridgelux maintains a flatness of 0.1 mm across the mounting surface of the array. Refer to Application Notes AN40 and AN41 for product handling, mounting and heat sink recommendations.

Color Binning Information

Figure 11: Graph of Warm and Neutral White Test Bins in xy Color Space

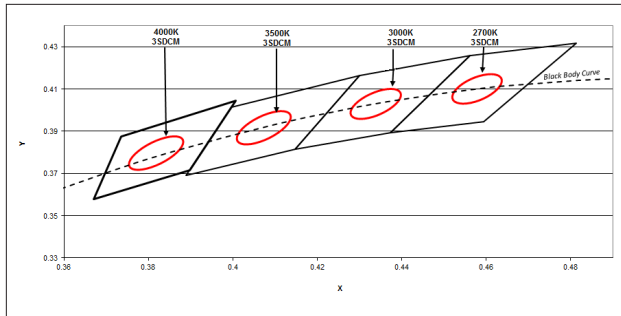

Note: Pulsed Test Conditions, $T_c = 25^\circ\text{C}$

Table 6: Warm and Neutral White xy Bin Coordinates and Associated Typical CCT

Bin Code	2700K	3000K	3500K	4000K
ANSI Bin (for reference only)	(2580K - 2870K)	(2870K - 3220K)	(3220K - 3710K)	(3710K - 4260K)
23 (3SDCM)	(2651K - 2794K)	(2968K - 3136K)	(3369K - 3586K)	(3851K - 4130K)
Center Point (x,y)	(0.4578, 0.4101)	(0.4338, 0.403)	(0.4073, 0.3917)	(0.3818, 0.3797)

Figure 12: Graph of Cool White Test Bins in xy Color Space

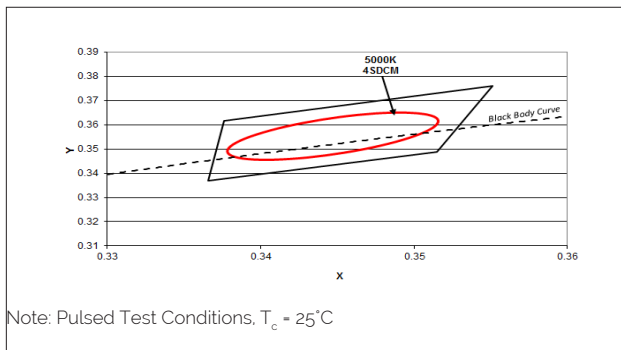

Note: Pulsed Test Conditions, $T_c = 25^\circ\text{C}$

Table 7: Cool White xy Bin Coordinates and Associated Typical CCT

Bin Code	5000K
ANSI Bin (for reference only)	(4745K - 5311K)
24 (4SDCM)	(4801K - 5282K)
Center Point (x,y)	(0.3447, 0.3553)

Packaging and Labeling

Figure 13: Drawing for V10 Packaging Labeling

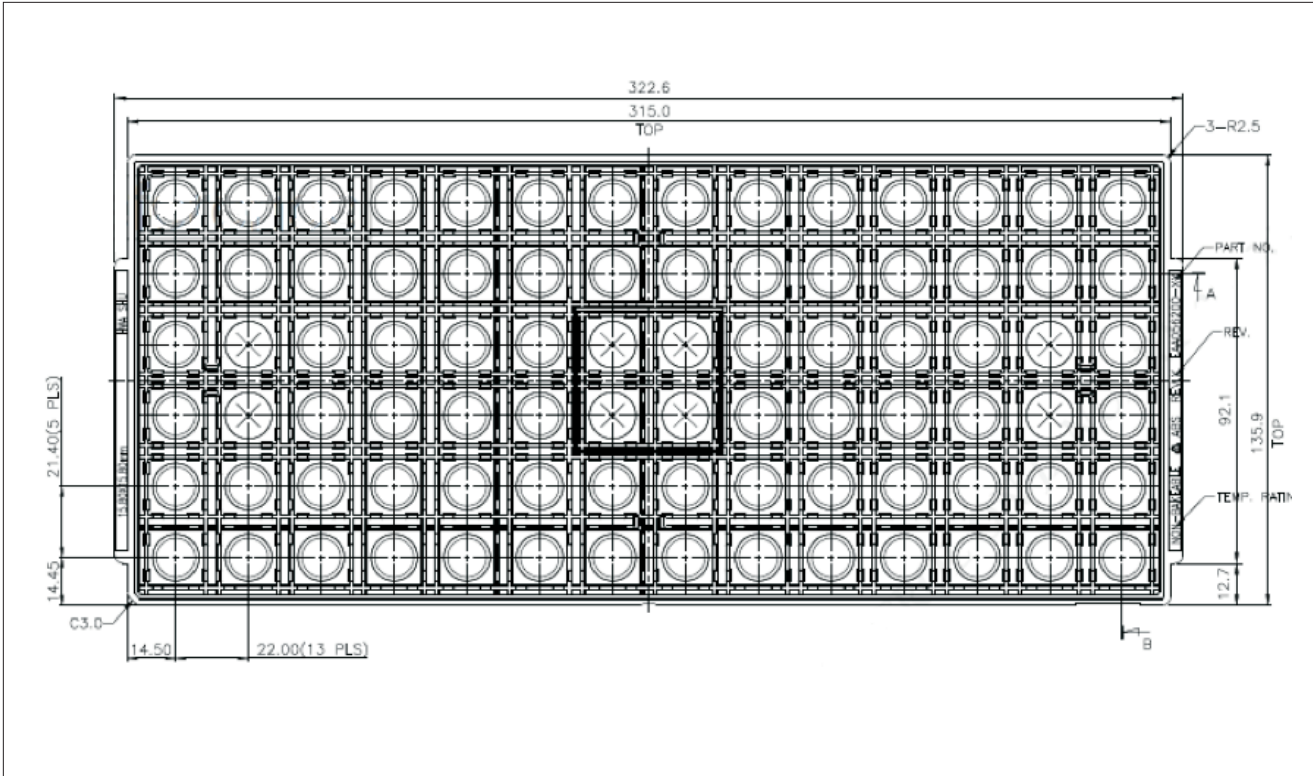

Notes for Figure 13:

1. Dimensions are in millimeters
2. Tolerances: XX - ± 0.25 , XXX - ± 0.13 , X'0' - $\pm 0'30$
3. Trays are stackable without interference and will not stick together during unstacking operation

Packaging and Labeling

Figure 14: V Series Packaging and Labeling

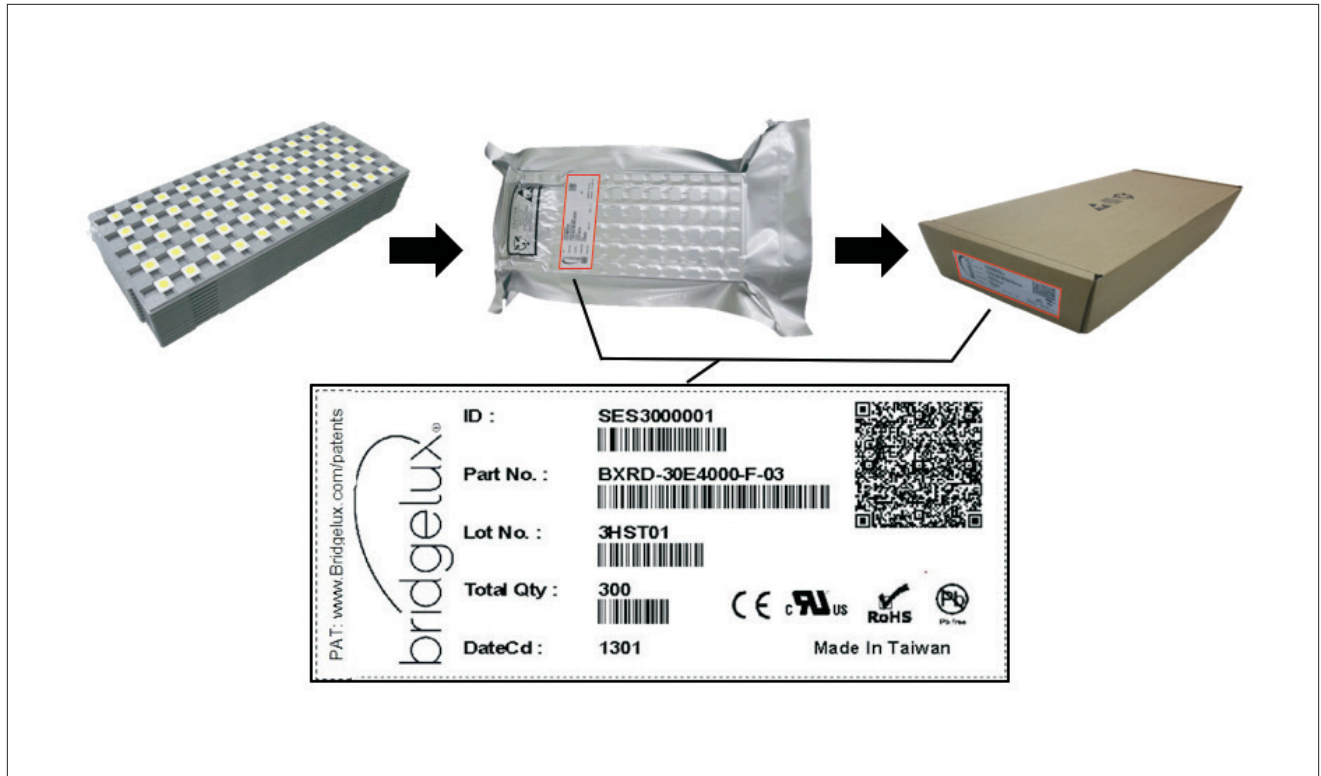

Notes for Figure 14:

1. Each tray holds 84 COB Arrays, 10 trays are stacked and one empty tray placed on top to cover the top tray.
2. Stacked trays are to contain only 1 part number and be vacuum sealed in an anti-static bag and placed in its own individual box.
3. Each bag and box is to be labeled as shown above.

Figure 15: Product Labeling

Bridgelux COB arrays have laser markings on the back side of the substrate to help with product identification. In addition to the product identification markings, Bridgelux COB arrays also contain markings for internal Bridgelux manufacturing use only. The image below shows which markings are for customer use and which ones are for Bridgelux internal use only. The Bridgelux internal manufacturing markings are subject to change without notice, however these will not impact the form, function or performance of the COB array.



Design Resources

Application Notes

Bridgelux has developed a comprehensive set of application notes and design resources to assist customers in successfully designing with the V Series product family of LED array products. For a list of resources under development, visit www.bridgelux.com.

Optical Source Models

Optical source models and ray set files are available for all Bridgelux products. For a list of available formats, visit www.bridgelux.com.

3D CAD Models

Three dimensional CAD models depicting the product outline of all Bridgelux V Series LED arrays are available in both IGS and STEP formats. Please contact your Bridgelux sales representative for assistance.

Precautions

CAUTION: CHEMICAL EXPOSURE HAZARD

Exposure to some chemicals commonly used in luminaire manufacturing and assembly can cause damage to the LED array. Please consult Bridgelux Application Note AN41 for additional information.

CAUTION: EYE SAFETY

Eye safety classification for the use of Bridgelux V Series LED arrays is in accordance with IEC specification EN62471: Photobiological Safety of Lamps and Lamp Systems. V Series LED arrays are classified as Risk Group 1 (Low Risk) when operated at or below the maximum drive current. Please use appropriate precautions. It is important that employees working with LEDs are trained to use them safely.

CAUTION: RISK OF BURN

Do not touch the V Series LED array during operation. Allow the array to cool for a sufficient period of time before handling. The V Series LED array may reach elevated temperatures such that could burn skin when touched.

CAUTION

CONTACT WITH LIGHT EMITTING SURFACE (LES)

Avoid any contact with the LES. Do not touch the LES of the LED array or apply stress to the LES (yellow phosphor resin area). Contact may cause damage to the LED array.

Optics and reflectors must not be mounted in contact with the LES (yellow phosphor resin area). Use the mechanical features of the LED array housing, edges and/or mounting holes to locate and secure optical devices as needed.

Disclaimers

MINOR PRODUCT CHANGE POLICY

The rigorous qualification testing on products offered by Bridgelux provides performance assurance. Slight cosmetic changes that do not affect form, fit, or function may occur as Bridgelux continues product optimization.

STANDARD TEST CONDITIONS

Unless otherwise stated, array testing is performed at the nominal drive current.

About Bridgelux: We Build Light That Transforms

At Bridgelux, we help companies, industries and people experience the power and possibility of light. Since 2002, we've designed LED solutions that are high performing, energy efficient, cost effective and easy to integrate. Our focus is on light's impact on human behavior, delivering products that create better environments, experiences and returns—both experiential and financial. And our patented technology drives new platforms for commercial and industrial luminaires.

For more information about the company, please visit
bridgelux.com
twitter.com/Bridgelux
facebook.com/Bridgelux
WeChat ID: BridgeluxInChina



101 Portola Avenue
Livermore, CA 94551
Tel (925) 583-8400
Fax (925) 583-8410
www.bridgelux.com

© 2016 Bridgelux, Inc. All rights reserved 2016. Product specifications are subject to change without notice. Bridgelux, the Bridgelux stylized logo design and V Series are registered trademarks, and Decor Series is a trademark of Bridgelux, Inc. All other trademarks are the property of their respective owners.

Bridgelux V10 Array Series Product Data Sheet DS42 Rev. E (06/2016)

单击下面可查看定价，库存，交付和生命周期等信息

[>>Bridgelux\(普瑞光电\)](#)