

DATA SHEET

METAL OXIDE VARISTORS POWER SUPPLY

14H Series

RoHS compliant & Halogen free



Product specification— April 20, 2023 V.3

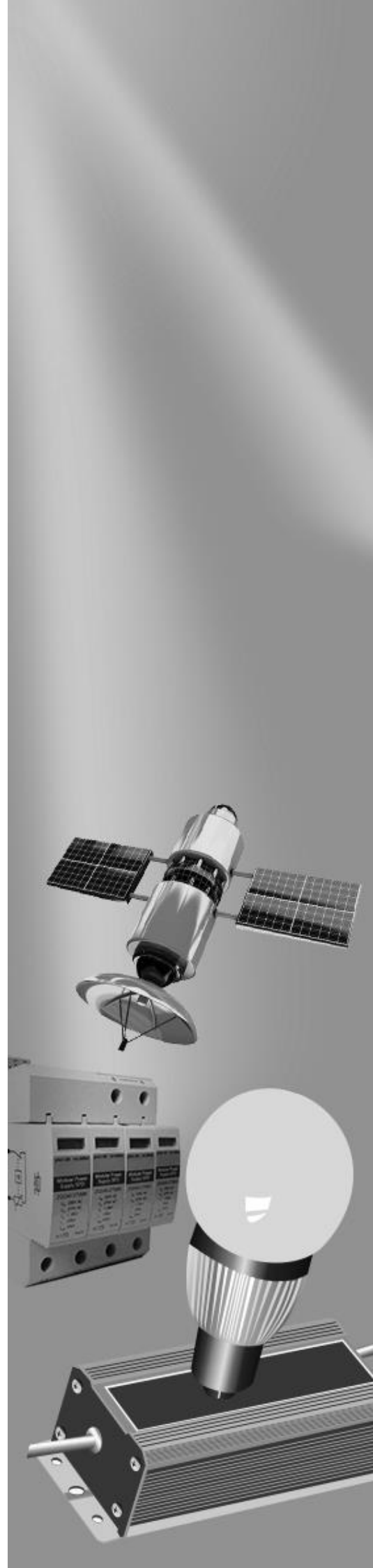

Metal Oxide Varistor (MOV) Data Sheet

Features

- Wide operating voltage (V_{1mA}) range from 18V to 1800V
- Fast responding to transient over-voltage
- Large absorbing transient energy capability
- Low clamping ratio and no follow-on current
- Meets MSL level 1, per J-STD-020
- Operating Temperature: $-40^{\circ}\text{C} \sim +140^{\circ}\text{C}$
- Storage Temperature: $-40^{\circ}\text{C} \sim +140^{\circ}\text{C}$
- Safety certification: UL: E327997
 TUV: B0960480010
 CQC:17001172544
 CSA: 246579



Applications

- Transistor, diode, IC, thyristor or triac semiconductor protection
- Surge protection in consumer electronics
- Surge protection in industrial electronics
- Surge protection in electronic home appliances, gas and petroleum appliances
- Relay and electromagnetic valve surge absorption

Part Number Code

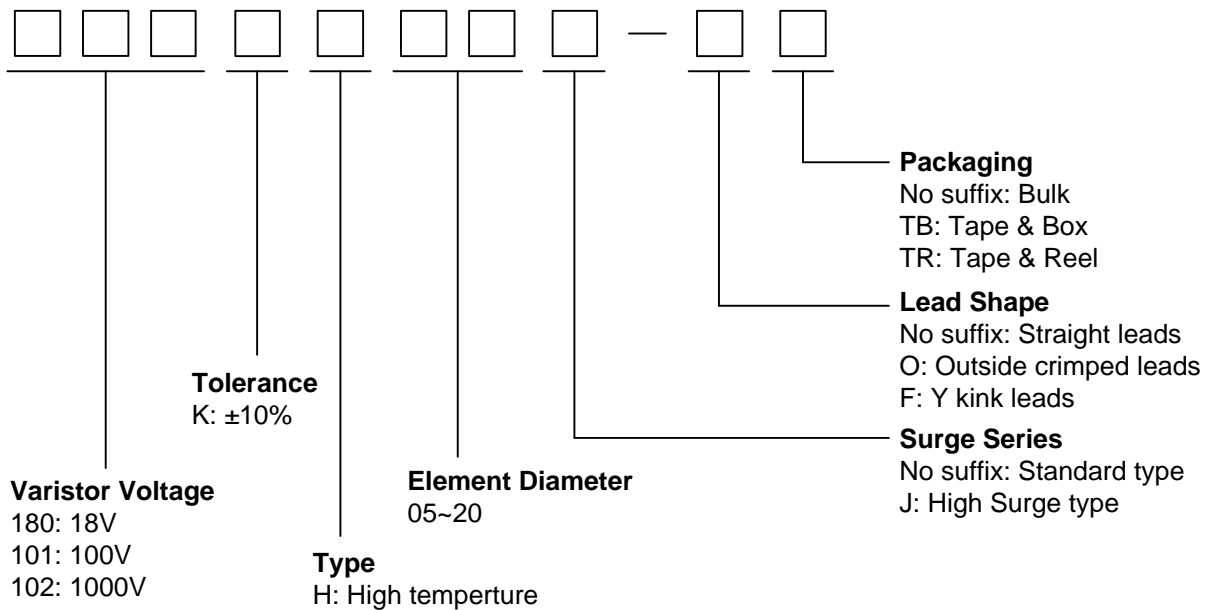

Dimensions

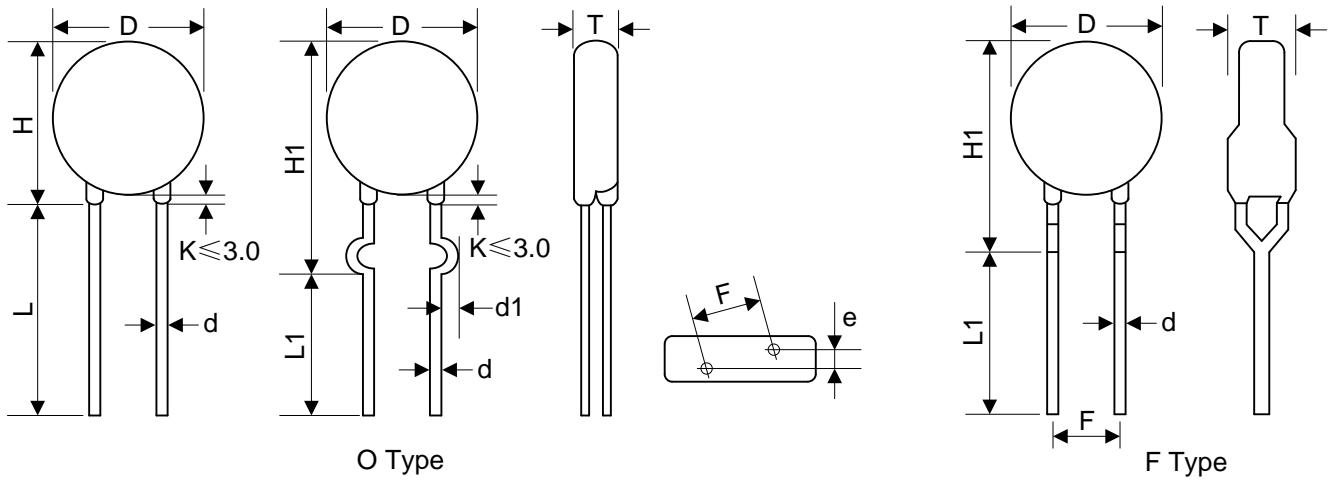

Table 1	
Unit: mm	
Symbol	Dimension
H	14.5~20.0
H1	17.0~23.0
L(min.)	20.0
L1(min.)	15.0
D	14.0~17.5
F(±0.8)	7.5
T	Table 2
e(±0.8)	Table 2
d(±0.05)	0.8
d1(±0.4)	1.4

Table 2					
Unit: mm					
Model	T	e	Model	T	e
180K	2.55~5.30	1.5	361K	3.38~6.70	2.7
220K	2.65~5.44	1.6	391K	3.48~6.88	2.8
270K	2.76~5.64	1.8	431K	3.61~7.13	3.0
330K	2.89~5.83	1.7	471K	3.74~7.37	3.2
390K	2.84~5.61	1.8	511K	3.87~7.62	3.4
470K	2.96~5.83	1.9	561K	4.03~7.92	3.6
560K	3.11~6.08	2.0	621K	4.23~8.29	3.9
680K	3.31~6.37	2.2	681K	4.43~8.66	4.2
820K	2.64~5.31	1.8	751K	4.65~8.73	4.3
101K	2.74~5.48	2.0	781K	4.75~8.79	4.4
121K	2.84~5.68	2.2	821K	4.88~9.01	4.6
151K	2.69~5.47	1.8	911K	5.18~9.05	4.8
181K	2.79~5.66	1.9	102K	5.47~9.50	5.1
201K	2.87~5.82	2.0	112K	5.80~10.0	5.4
221K	2.92~5.84	2.1	122K	6.13~10.5	5.6
241K	2.99~5.97	2.2	142K	6.78~11.5	5.9
271K	3.08~6.15	2.4	162K	7.44~12.5	6.5
301K	3.18~6.33	2.5	182K	8.09~13.5	6.9
331K	3.28~6.52	2.5			

METAL OXIDE VARISTORS

14H

Electrical Characteristics

Part Number		Maximum Allowable Voltage		Varistor Voltage	Maximum Clamping Voltage		Withstanding Surge Current		Maximum Energy (10/1000µs)		Rated Power	Typical Capacitance (Reference)
Standard	High Surge	V _{AC} (V)	V _{DC} (V)	V _{1mA} (V)	I _P (A)	V _C (V)	I (A) Standard	I (A) High Surge	(J) Standard	(J) High Surge	(W)	@1KHz (pf)
180KH14	180KH14J	11	14	18(15~21.6)	10	36	1000	2000	4.0	7.0	0.1	11100
220KH14	220KH14J	14	18	22(19.5~26)	10	43	1000	2000	5.0	8.0	0.1	9100
270KH14	270KH14J	17	22	27(24~31)	10	53	1000	2000	6.0	10.0	0.1	7400
330KH14	330KH14J	20	26	33(29.5~36.5)	10	65	1000	2000	7.5	12.0	0.1	6100
390KH14	390KH14J	25	31	39(35~43)	10	77	1000	2000	8.6	13.0	0.1	5100
470KH14	470KH14J	30	38	47(42~52)	10	93	1000	2000	10.0	17.0	0.1	4300
560KH14	560KH14J	35	45	56(50~62)	10	110	1000	2000	11.0	20.0	0.1	3600
680KH14	680KH14J	40	56	68(61~75)	10	135	1000	2000	14.0	24.0	0.1	2900
820KH14	820KH14J	50	65	82(74~90)	50	135	4500	6000	22.0	27.0	0.6	2400
101KH14	101KH14J	60	85	100(90~110)	50	165	4500	6000	28.0	33.0	0.6	2000
121KH14	121KH14J	75	100	120(108~132)	50	200	4500	6000	32.0	40.0	0.6	1700
151KH14	151KH14J	95	125	150(135~165)	50	250	4500	6000	40.0	53.0	0.6	1300
181KH14	181KH14J	115	150	180(162~198)	50	300	4500	6000	50.0	60.0	0.6	1100
201KH14	201KH14J	130	170	200(180~220)	50	340	4500	6000	57.0	70.0	0.6	1000
221KH14	221KH14J	140	180	220(198~242)	50	360	4500	6000	60.0	78.0	0.6	900
241KH14	241KH14J	150	200	240(216~264)	50	395	4500	6000	63.0	84.0	0.6	830
271KH14	271KH14J	175	225	270(243~297)	50	455	4500	6000	70.0	99.0	0.6	740
301KH14	301KH14J	190	250	300(270~330)	50	500	4500	6000	77.0	108	0.6	670
331KH14	331KH14J	210	275	330(297~363)	50	550	4500	6000	85.0	115	0.6	610
361KH14	361KH14J	230	300	360(324~396)	50	595	4500	6000	93.0	130	0.6	560
391KH14	391KH14J	250	320	390(351~429)	50	650	4500	6000	100	140	0.6	510
431KH14	431KH14J	275	350	430(387~473)	50	710	4500	6000	115	155	0.6	460
471KH14	471KH14J	300	385	470(423~517)	50	775	4500	6000	118	175	0.6	430
511KH14	511KH14J	320	415	510(459~561)	50	845	4500	6000	121	180	0.6	390
561KH14	561KH14J	350	460	560(504~616)	50	925	4500	6000	125	185	0.6	360
621KH14	621KH14J	385	505	620(558~682)	50	1025	4500	6000	128	190	0.6	320
681KH14	681KH14J	420	560	680(612~748)	50	1120	4500	6000	130	200	0.6	290
751KH14	751KH14J	460	615	750(675~825)	50	1240	4500	6000	143	210	0.6	270
781KH14	781KH14J	485	640	780(702~858)	50	1290	4500	6000	148	220	0.6	260
821KH14	821KH14J	510	670	820(738~902)	50	1355	4500	6000	157	235	0.6	240
911KH14	911KH14J	550	745	910(819~1001)	50	1500	4500	6000	175	255	0.6	220
102KH14	102KH14J	625	825	1000(900~1100)	50	1650	4500	6000	190	280	0.6	200
112KH14	112KH14J	680	895	1100(990~1210)	50	1815	4500	6000	213	310	0.6	180
122KH14	122KH14J	750	990	1200(1080~1320)	50	1980	4500	6000	232	324	0.6	160
142KH14	142KH14J	880	1140	1400(1260~1540)	50	2310	4500	6000	238	327	0.6	150
162KH14	162KH14J	1000	1280	1600(1440~1760)	50	2640	4500	6000	243	331	0.6	140
182KH14	182KH14J	1100	1465	1800(1620~1980)	50	2970	4500	5000	250	335	0.6	130

- Notes: 1. The tolerance of varistor voltage between 18V and 27V is more than 10%.
 2. Varistor voltage ≥ 1200V, structure diagram is F type.
 3. Leakage Current (@83% of V_{1mA}): IR ≤ 40µA (180K~680K) ; IR ≤ 20µA (820K~182K)

Electrical Ratings

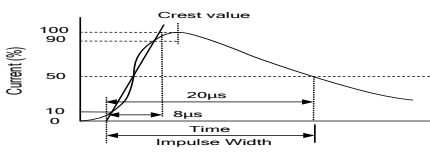
Items	Test Condition/Description	Requirement					
Varistor Voltage	The voltage between the two terminals with the specified measuring current 1mA.DC applied is called Vb.	To meet the Specified value					
Maximum Allowable Voltage	The recommended maximum sine wave voltage (RMS) or the Maximum DC voltage can be applied continuously.						
Maximum Clamping Voltage	The maximum voltage between the two terminals with the specification standard impulse current. Applied waveform: 8/20µs 						
Rated Wattage	The maximum average power that can be applied within the specified ambient temperature.						
Energy	The maximum energy within the varistor voltage change of ±10% when one impulse of 10/1000µs or 2ms is applied.						
Withstanding Surge Current	The maximum current within the varistor voltage change of ±10% with the standard impulse current (8/20µs) applied one time.						
Varistor Voltage Temp. Coefficient	$\left \frac{V_{1mA@140^{\circ}C} - V_{1mA@25^{\circ}C}}{V_{1mA@25^{\circ}C}} \times \frac{1}{115} \times 100\%(\%/^{\circ}C) \right $ $\left \frac{V_{1mA@-40^{\circ}C} - V_{1mA@25^{\circ}C}}{V_{1mA@25^{\circ}C}} \times \frac{1}{65} \times 100\%(\%/^{\circ}C) \right $	≤0.05%/°C					
Surge Life	The change of Vb shall be measured after the impulse listed below which is applied 10,000 times continuously with the interval of ten seconds at room temperature. <table border="1" data-bbox="438 1299 1204 1388"> <tr> <td rowspan="2">14Φ series</td> <td>180K to 680K</td> <td>75A (8/20µs)</td> </tr> <tr> <td>820K to 182K</td> <td>150A (8/20µs)</td> </tr> </table>	14Φ series	180K to 680K	75A (8/20µs)	820K to 182K	150A (8/20µs)	$\frac{\Delta V_b}{V_b} \leq \pm 10\%$
14Φ series	180K to 680K		75A (8/20µs)				
	820K to 182K	150A (8/20µs)					

Soldering Recommendation

Lead-free Wave Soldering Recommendation

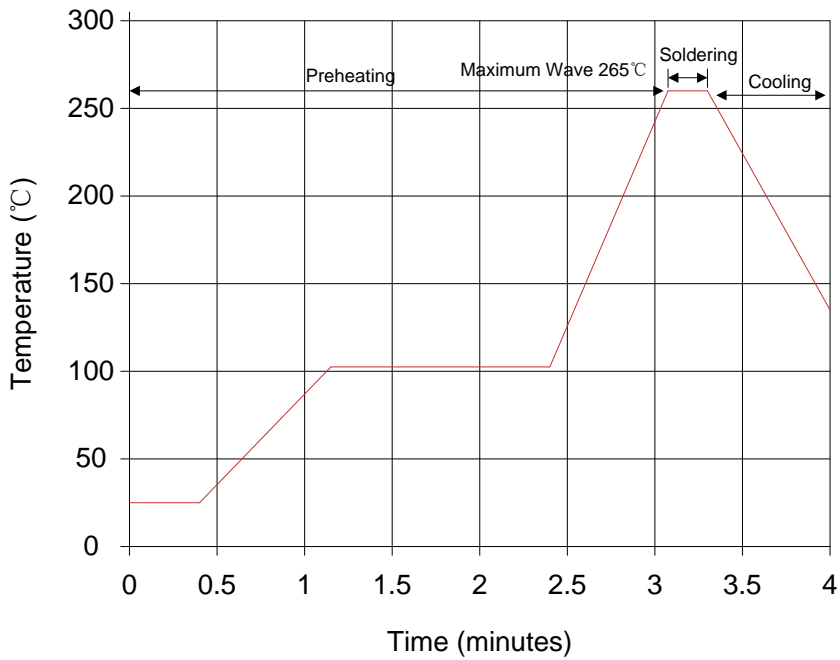

Item	Conditions
Peak Temperature	265°C
Dipping Time	10 seconds (max.)
Soldering	1 time

Recommendation Reworking Conditions with Soldering Iron

Item	Conditions
Temperature of Soldering Iron-tip	360°C (max.)
Soldering Time	3 seconds (max.)
Distance from Varistor	2mm (min.)

Mechanical Characteristics

Items	Test conditions / Methods	Specifications								
Tensile Strength of Terminals	Gradually applying the force specified and keeping the unit fixed for 10±1 sec. <table border="1"> <thead> <tr> <th>Terminal diameter (mm)</th> <th>Force (kg)</th> </tr> </thead> <tbody> <tr> <td>0.5<d≤0.8</td> <td>1.0</td> </tr> <tr> <td>0.8<d≤1.25</td> <td>2.0</td> </tr> <tr> <td>1.25<d</td> <td>4.0</td> </tr> </tbody> </table>	Terminal diameter (mm)	Force (kg)	0.5<d≤0.8	1.0	0.8<d≤1.25	2.0	1.25<d	4.0	No visible damage ΔV _{1mA} /V _{1mA} ≤5%
Terminal diameter (mm)	Force (kg)									
0.5<d≤0.8	1.0									
0.8<d≤1.25	2.0									
1.25<d	4.0									
Bending Strength of Terminals	Hold specimen and apply the force specified below to each lead. Bend the specimen to 90°, then return to the original position. Repeat the procedure in the opposite direction. <table border="1"> <thead> <tr> <th>Terminal diameter (mm)</th> <th>Force (kg)</th> </tr> </thead> <tbody> <tr> <td>0.5<d≤0.8</td> <td>0.5</td> </tr> <tr> <td>0.8<d≤1.25</td> <td>1.0</td> </tr> <tr> <td>1.25<d</td> <td>2.0</td> </tr> </tbody> </table>	Terminal diameter (mm)	Force (kg)	0.5<d≤0.8	0.5	0.8<d≤1.25	1.0	1.25<d	2.0	No visible damage ΔV _{1mA} /V _{1mA} ≤5%
Terminal diameter (mm)	Force (kg)									
0.5<d≤0.8	0.5									
0.8<d≤1.25	1.0									
1.25<d	2.0									
Vibration	Frequency range: 10~55 Hz Amplitude: 0.75mm or 98m/s ² Direction: 3 mutually perpendicular directions, 2hrs each.	No visible damage ΔV _{1mA} /V _{1mA} ≤5%								
Solder ability	Solder Temp: 245±5°C Dipping Time: 2±0.5 sec	At least 95% of terminal electrode is covered by new solder								
Resistance to Soldering Heat	Solder Temp: 260±5°C Dipping Time: 10±1 sec	No visible damage ΔV _{1mA} /V _{1mA} ≤10%								

Reliability

Items	Test conditions / Methods	Specifications															
High Temperature Storage	Ambient Temp: 125±2°C Duration: 1000hrs	ΔV _{1mA} /V _{1mA} ≤5%															
Low Temperature Storage	Ambient Temp: -40±2°C Duration: 1000hrs	ΔV _{1mA} /V _{1mA} ≤5%															
Humidity	Ambient Temp: 40±2°C, 90~95% R.H. Duration: 1000hrs	ΔV _{1mA} /V _{1mA} ≤5%															
Temperature Cycle	The conditions shown below shall be repeated 5 cycles <table border="1"> <thead> <tr> <th>Step</th> <th>Temperature (°C)</th> <th>Period (minutes)</th> </tr> </thead> <tbody> <tr> <td>1</td> <td>-40±3</td> <td>30±3</td> </tr> <tr> <td>2</td> <td>Room temperature</td> <td>15±3</td> </tr> <tr> <td>3</td> <td>125±3</td> <td>30±3</td> </tr> <tr> <td>4</td> <td>Room temperature</td> <td>15±3</td> </tr> </tbody> </table>	Step	Temperature (°C)	Period (minutes)	1	-40±3	30±3	2	Room temperature	15±3	3	125±3	30±3	4	Room temperature	15±3	No visible damage ΔV _{1mA} /V _{1mA} ≤5%
Step	Temperature (°C)	Period (minutes)															
1	-40±3	30±3															
2	Room temperature	15±3															
3	125±3	30±3															
4	Room temperature	15±3															
High Temperature Load	Ambient Temp: 125±2°C Duration: 1000hrs Load: Max. Allowable Voltage In AC eara.	ΔV _{1mA} /V _{1mA} ≤10%															
Damp Heat Load	Ambient Temp: 40±2°C, 90~95% R.H. Duration: 1000hrs Load: Max. Allowable Voltage	No visible damage ΔV _{1mA} /V _{1mA} ≤10%															
Voltage Proof	Metal balls method, 1000Vac 1 min.(180K~331K), 1500Vac 1 min.(361K~182K)	No visible damage															

Power Derating Curve

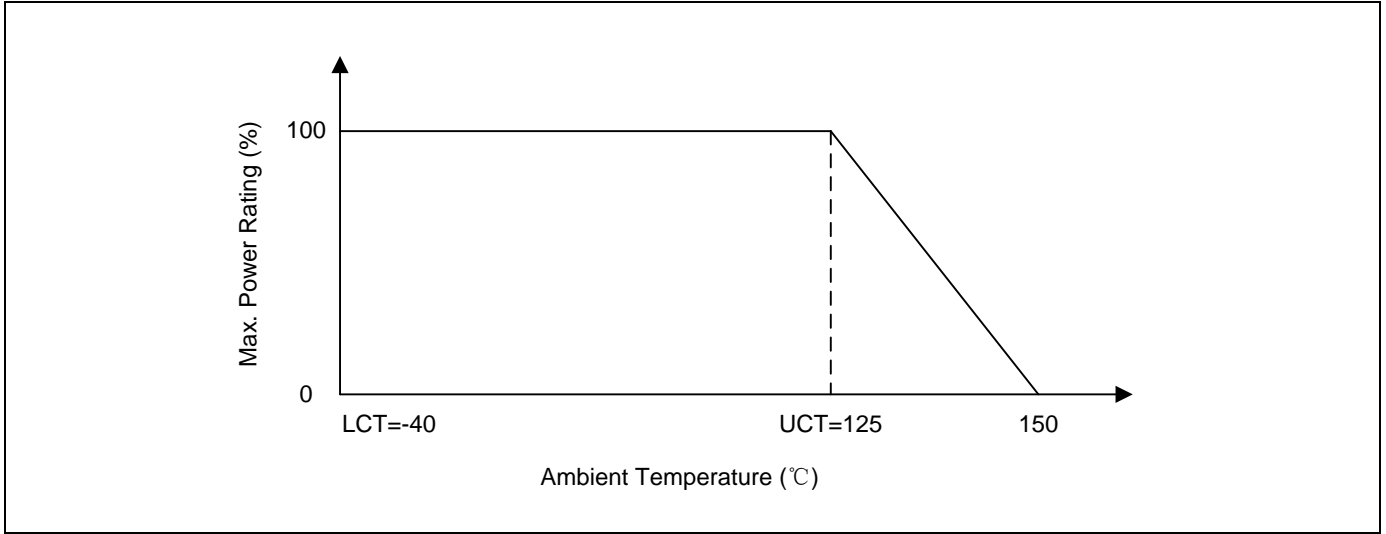

Maximum Surge Current Derating Curve

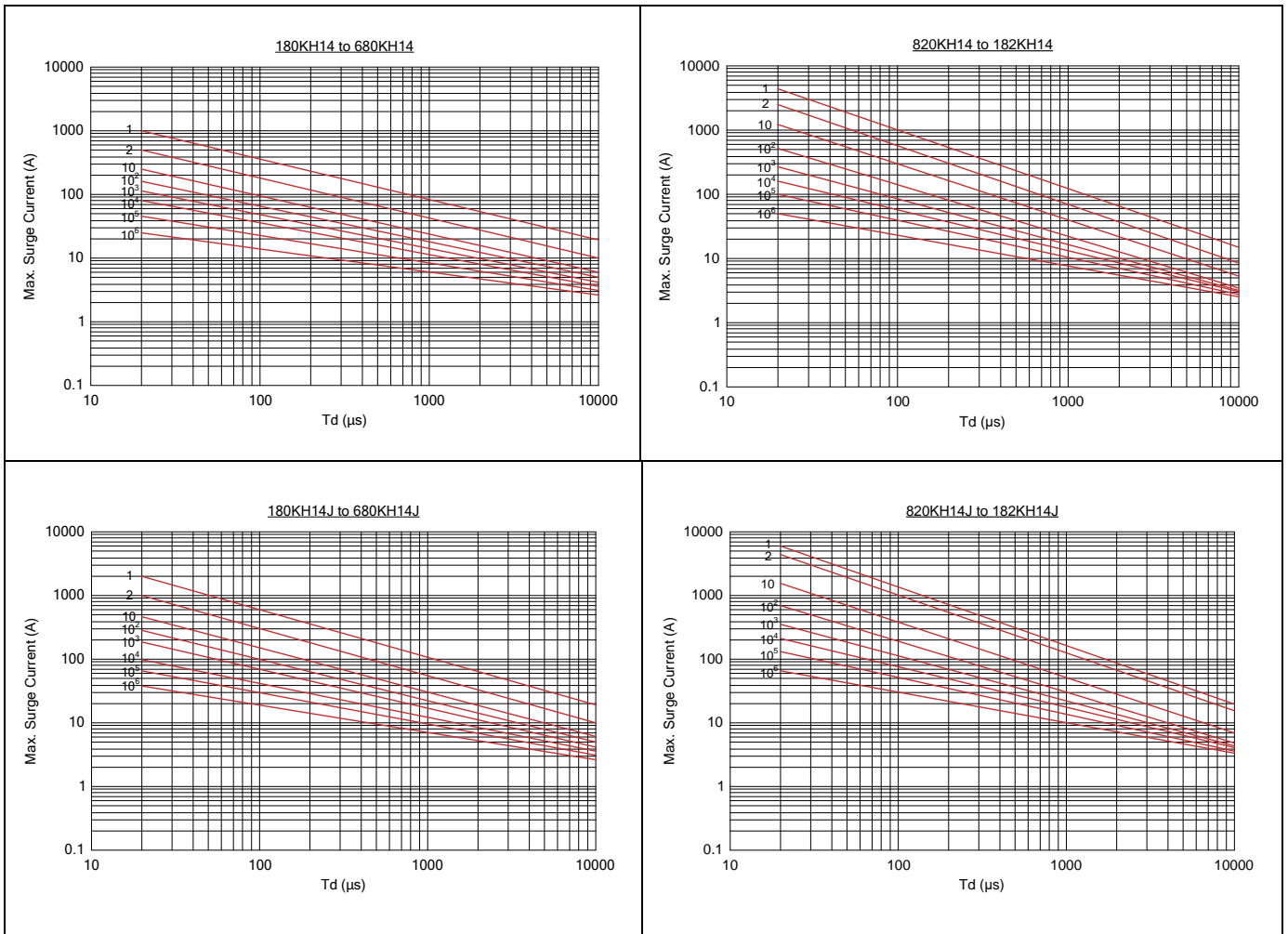

Maximum Leakage Current and Maximum Clamping Voltage Curve

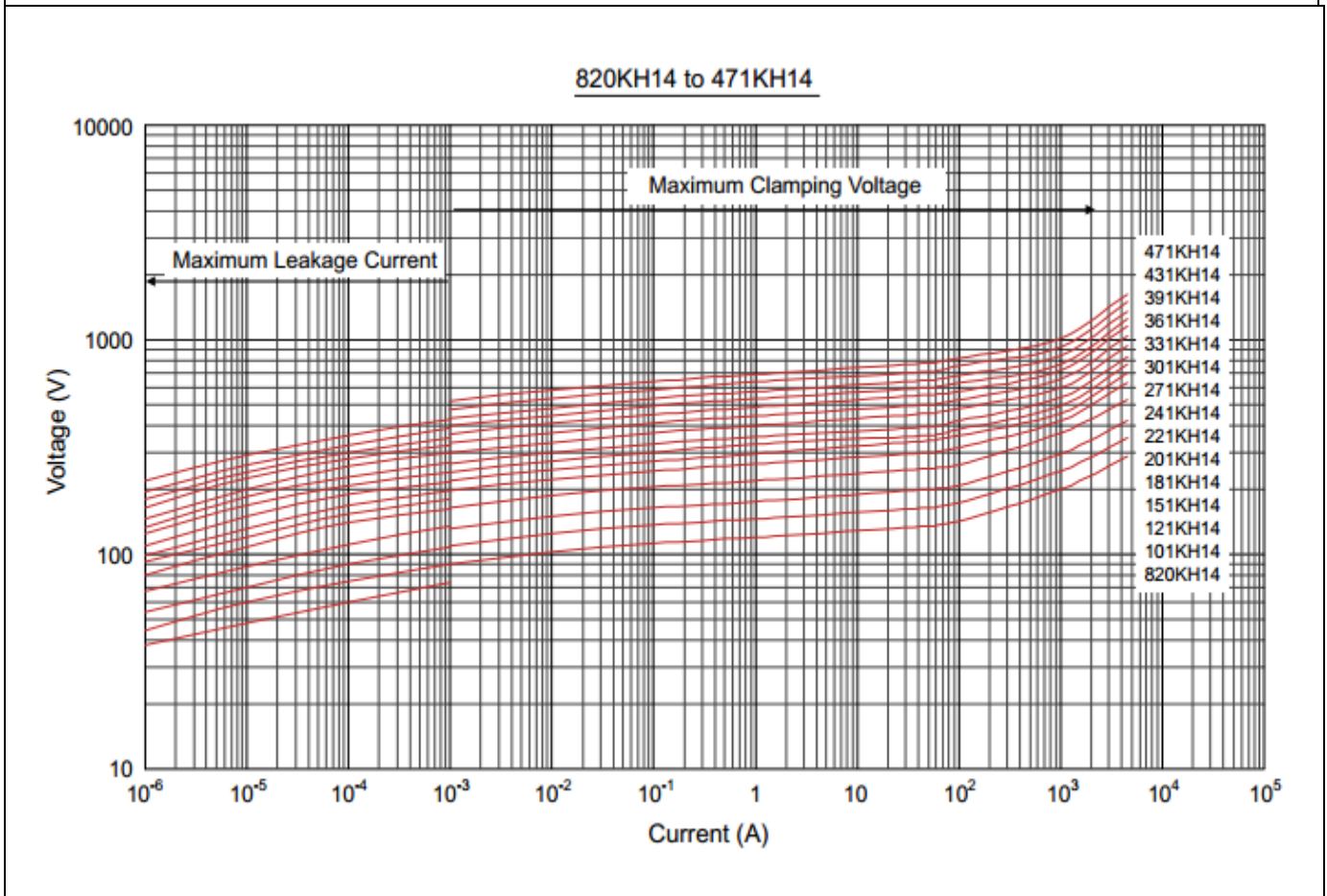
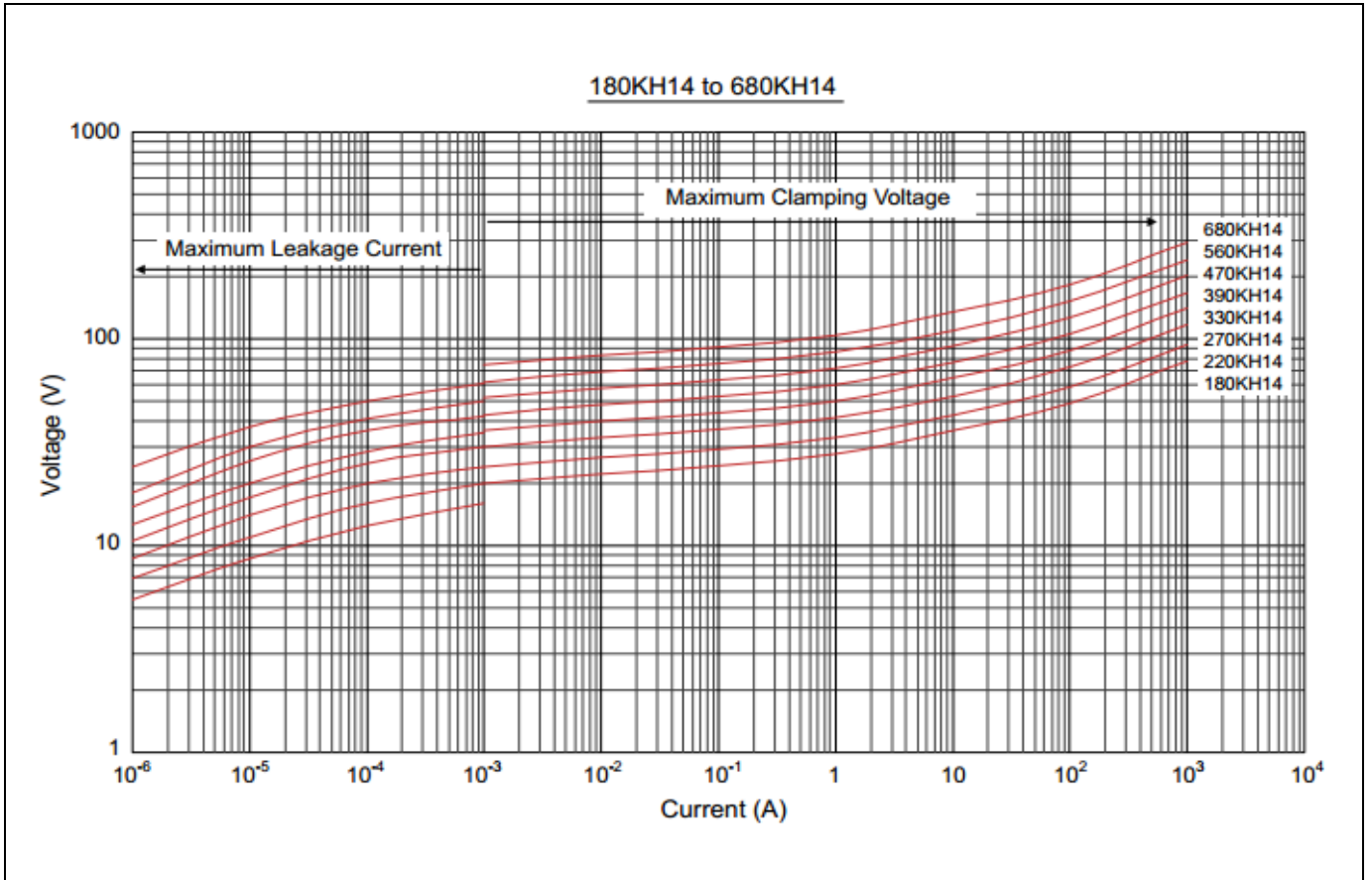

Maximum Leakage Current and Maximum Clamping Voltage Curve

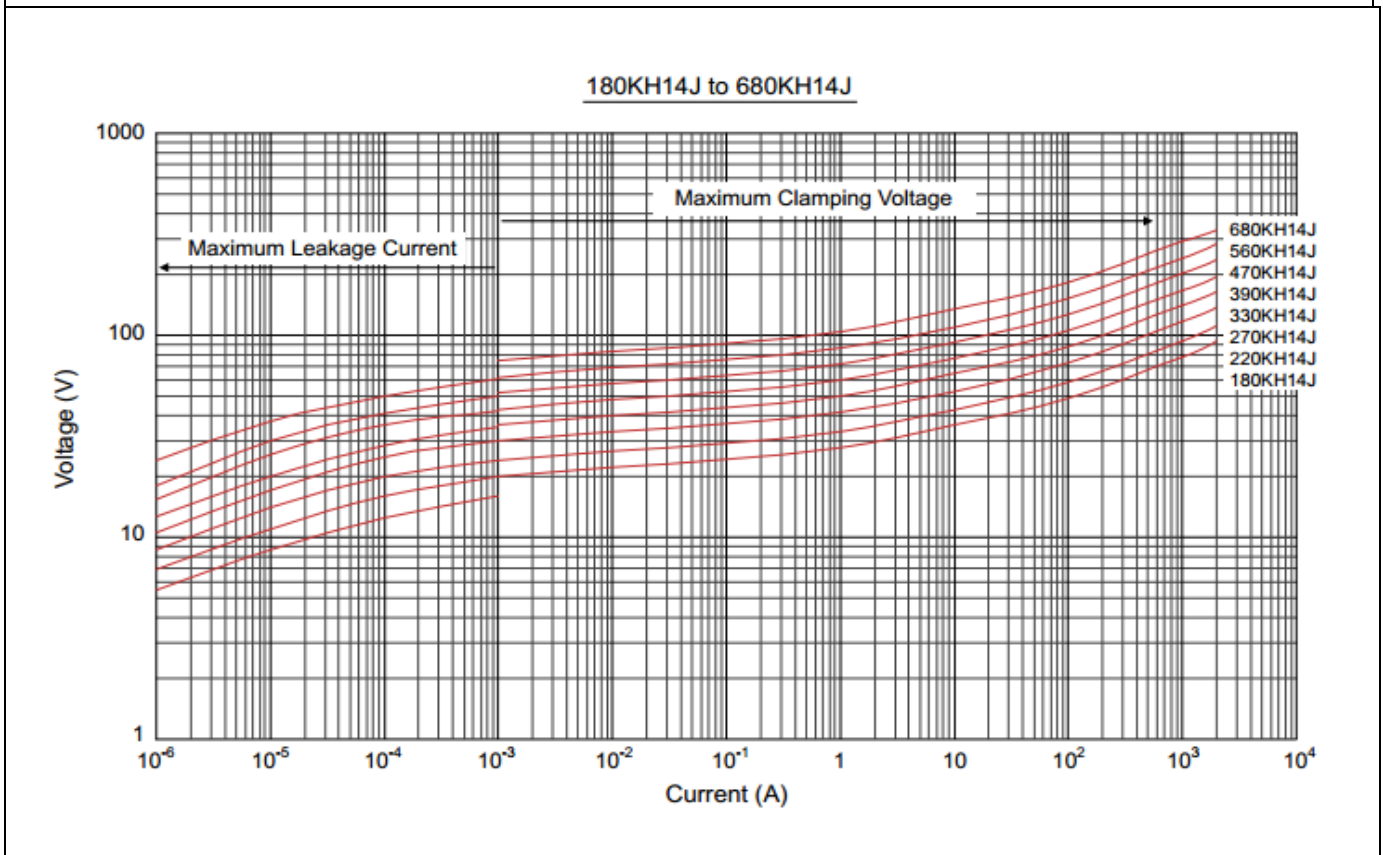
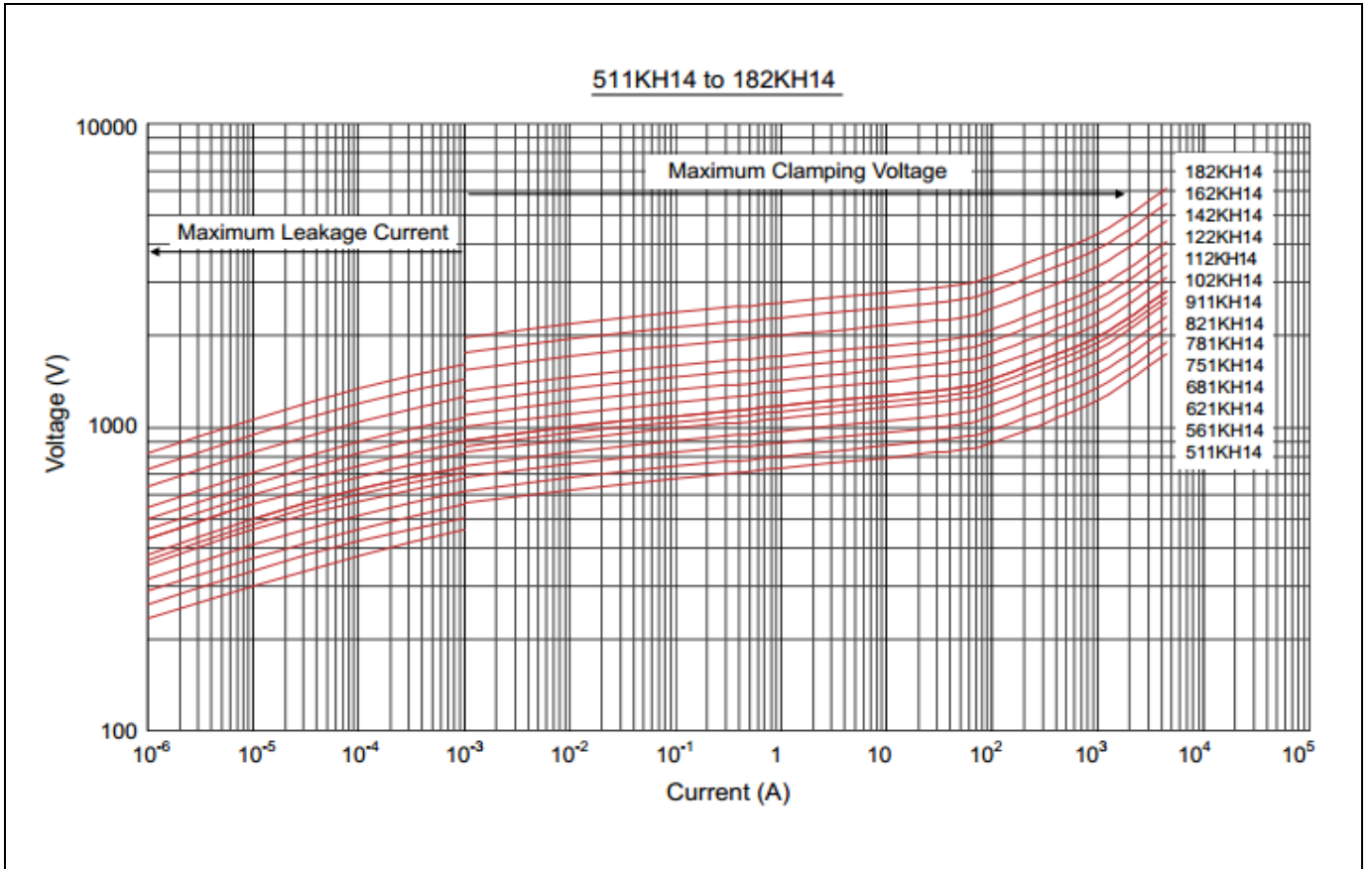

Maximum Leakage Current and Maximum Clamping Voltage Curve

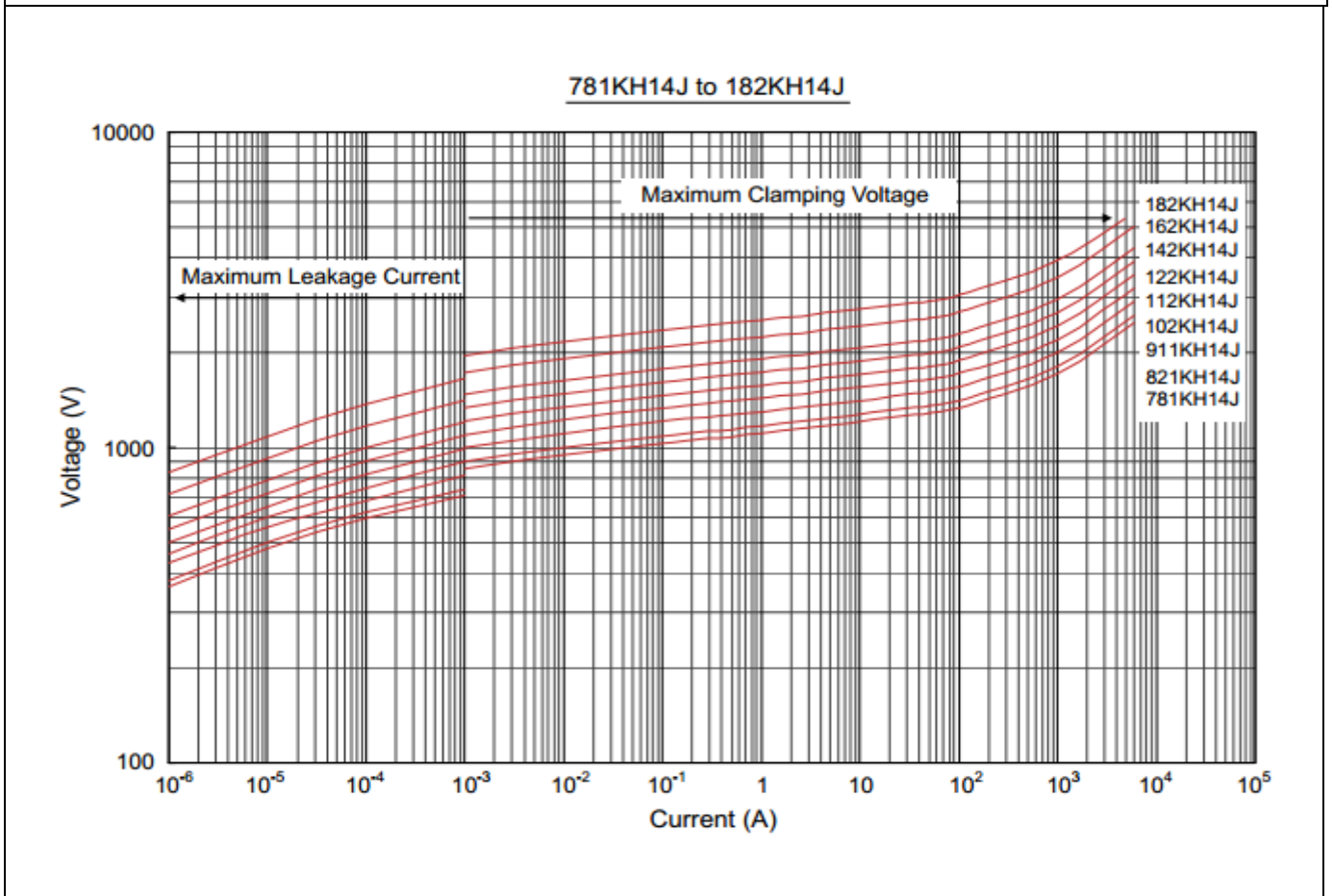
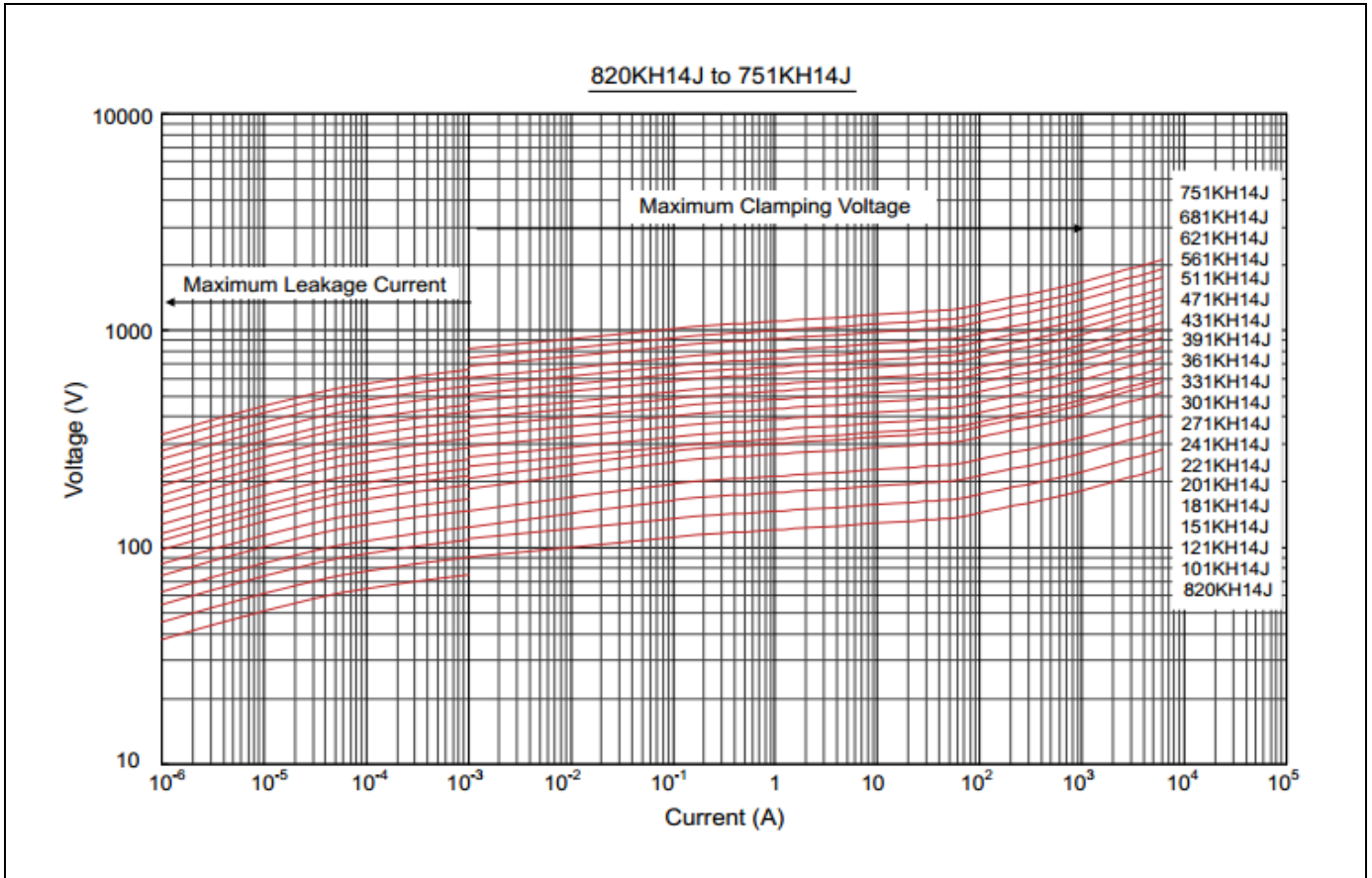

Marking Code

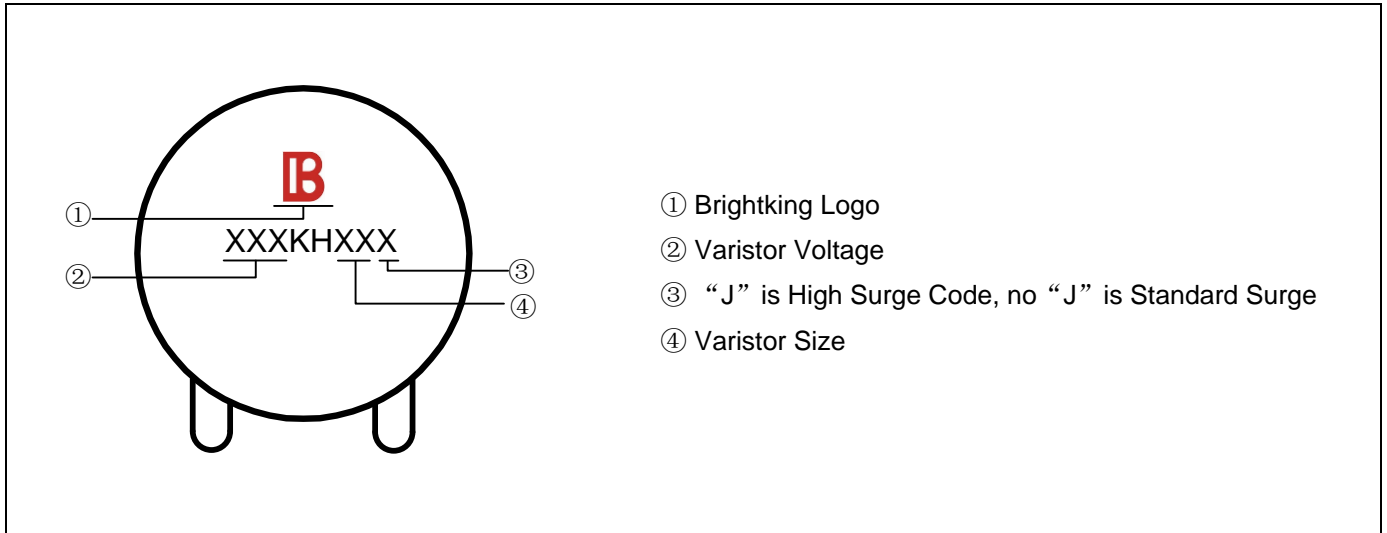

Taping Dimensions

Symbol	Dimensions (mm)
P	25.4±1.0
P0	12.7±1.0
P1	8.95±0.7
P2	12.7±1.3
F	7.5±0.8
h	0±4
W	18.0±1.0
W0	12.0±1.0
W1	9.0±0.5
W2	3.0max
H	20.0±2.0
I	1.0max
D0	4.0±0.2
t	0.6±0.3
B	40max

Quantity

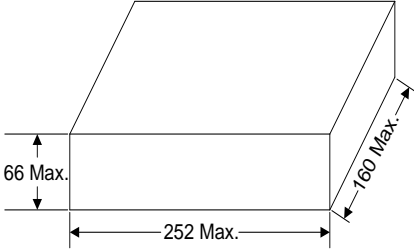
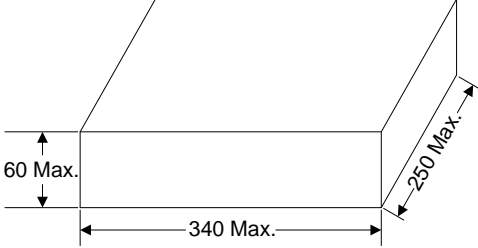
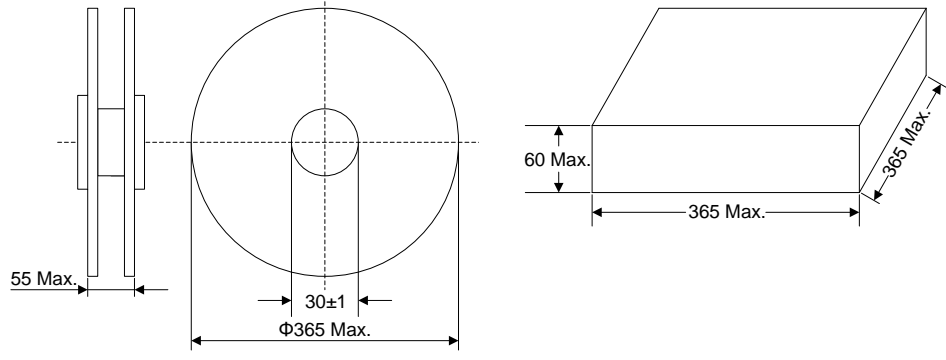
Packaging Dimensions (Unit: mm)	Quantity
<p>Bulk</p> 	400pcs/bag 2bags/box (180K~271K)
	300pcs/bag 2bags/box (331K~561K)
	250pcs/bag 2bags/box (621K~751K)
	200pcs/bag 2bags/box (781K~112K)
	150pcs/bag 2bags/box (122K~182K)
<p>Tape & Box</p> 	750pcs/box (180K~331K)
	500pcs/box (361K~561K)
	400pcs/box (621K~751K)
	300pcs/box (781K~112K)
<p>Tape & Reel</p> 	800pcs/reel (180K~331K)
	600pcs/reel (361K~561K)
	500pcs/reel (621K~751K) 400pcs/reel (781K~112K)

LEGAL DISCLAIMER

YAGEO, its distributors and agents (collectively, "YAGEO"), hereby disclaims any and all liabilities for any errors, inaccuracies or incompleteness contained in any product related information, including but not limited to product specifications, datasheets, pictures and/or graphics. YAGEO may make changes, modifications and/or improvements to product related information at any time and without notice.

YAGEO makes no representation, warranty, and/or guarantee about the fitness of its products for any particular purpose or the continuing production of any of its products. To the maximum extent permitted by law, YAGEO disclaims (i) any and all liability arising out of the application or use of any YAGEO product, (ii) any and all liability, including without limitation special, consequential or incidental damages, and (iii) any and all implied warranties, including warranties of fitness for a particular purpose, non-infringement and merchantability.

YAGEO products are designed for general purpose applications under normal operation and usage conditions. Please contact YAGEO for the applications listed below which require especially high reliability for the prevention of defects which might directly cause damage to the third party's life, body or property: Aerospace equipment (artificial satellite, rocket, etc.), Atomic energy-related equipment, Aviation equipment, Disaster prevention equipment, crime prevention equipment, Electric heating apparatus, burning equipment, Highly public information network equipment, data-processing equipment, Medical devices, Military equipment, Power generation control equipment, Safety equipment, Traffic signal equipment, Transportation equipment and Undersea equipment, or for any other application or use in which the failure of YAGEO products could result in personal injury or death, or serious property damage. Particularly **YAGEO Corporation and its affiliates do not recommend the use of commercial or automotive grade products for high reliability applications or manned space flight.**

Information provided here is intended to indicate product specifications only. YAGEO reserves all the rights for revising this content without further notification, as long as products are unchanged. Any product change will be announced by PCN.

单击下面可查看定价，库存，交付和生命周期等信息

[>>Brightking\(君耀电子\)](#)