

DATA SHEET

METAL OXIDE VARISTORS POWER SUPPLY

TMOV 20M(E,N) series

RoHS compliant & Halogen free



Product specification— November 24, 2021 V.2



Metal Oxide Varistor Data Sheet

Features

- TMOV integrated thermal protection device
- High peak surge current rating up to 10KA
- Designed to facilitate compliance to UL1449 for TVSS products
- Wide operating voltage (V_{1mA}) range from 18V to 1200V
- Rated current: 15A
- Rated Functioning Temperature: 136(°C)
- Fast responding to transient over-voltage and limited current
- Large absorbing transient energy capability
- Low clamping ratio and no follow-on current
- Three-lead version available for indication purposes
- Meets MSL level 1, per J-STD-020
- Operating Temperature: -40°C ~ +85°C
- Storage Temperature: -40°C ~ +85°C
- Safety certification: UL: E327997

Applications

- AC power line or AC/DC supplies
- Transistor, diode, IC, thyristor or triac semiconductor protection
- Surge protection in consumer electronics
- Surge protection in industrial electronics
- Surge protection in electronic home appliances, gas and petroleum appliances
- Relay and electromagnetic valve surge absorption
- AC panel protection Modules

Part number code

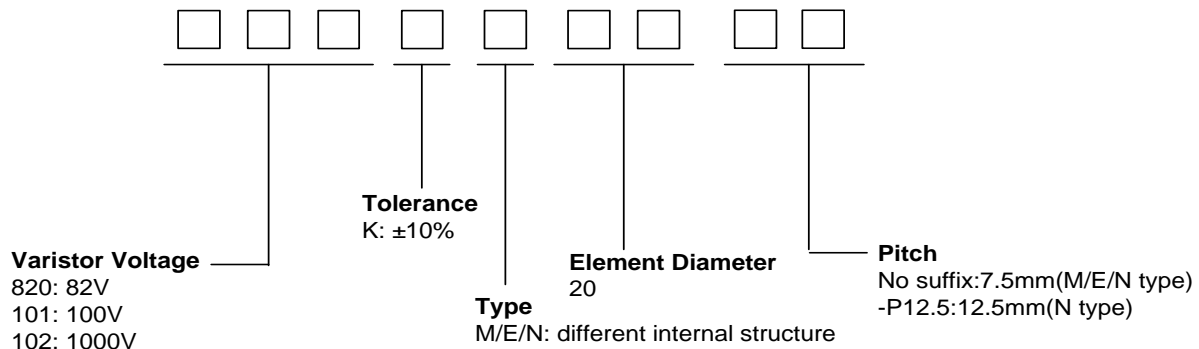

Lead configurations and application examples

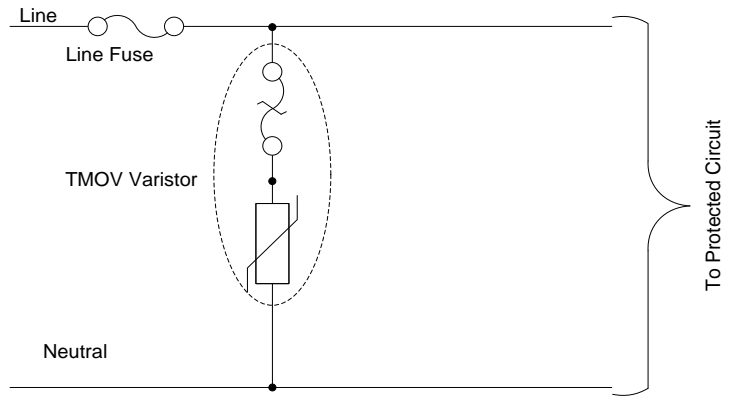
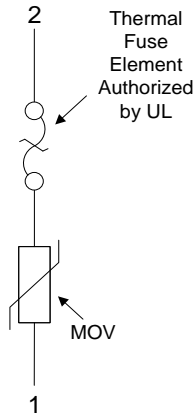
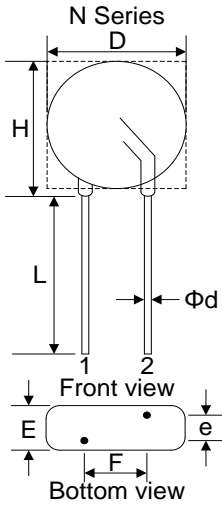

To Protected Circuit

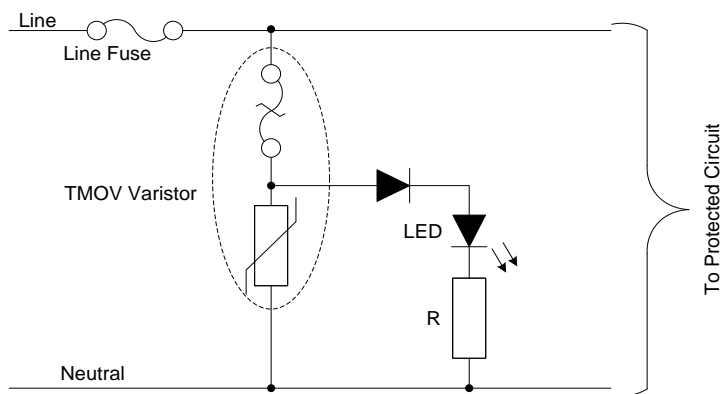
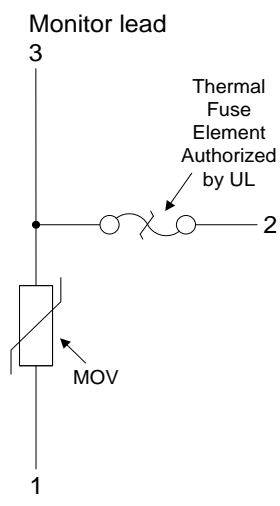
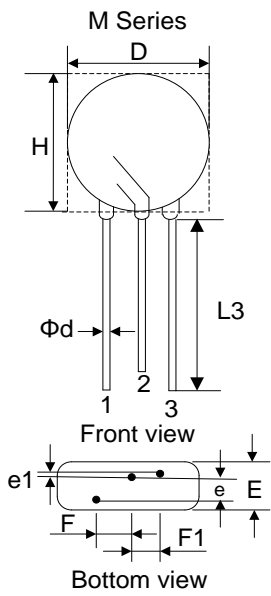

To Protected Circuit

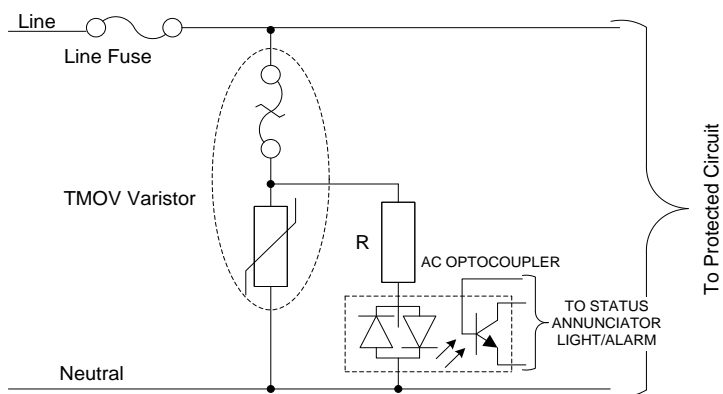

To Protected Circuit

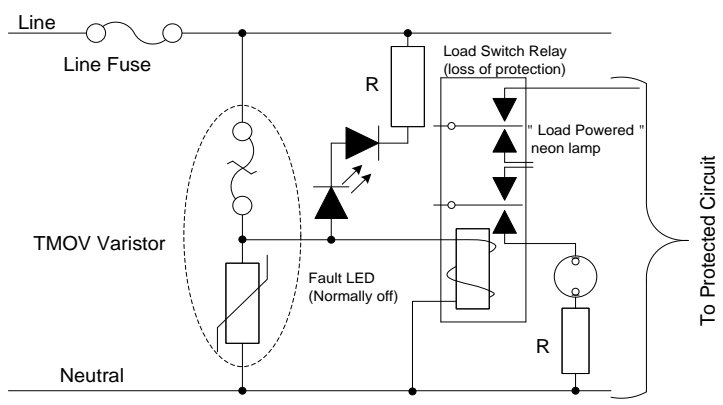
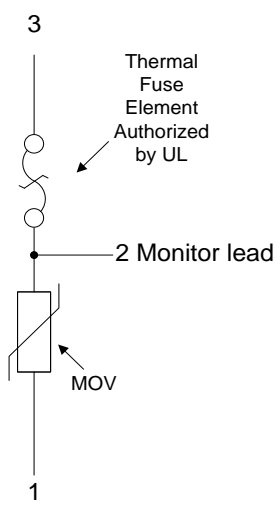
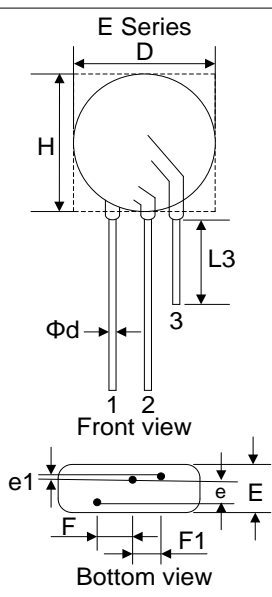

To Protected Circuit

Dimensions

Symbol		BK'S M / E / N Varistor		
		20M	20E	20N
D (max.)		24.0	24.0	24.0
H (max.)		26.0	26.0	26.0
F (±1.0)		7.5	7.5	12.5 / 7.5
F1 (±1.0)		5.0	5.0	-
e (max.)	180K~121K	3.0	3.0	3.0
	151K~391K	3.8	3.8	3.8
	431K~621K	5.5	5.5	5.5
	681K~911K	7.8	7.8	7.8
	102K~122K	10.0	10.0	10.0
e1	180K~121K	1.5±1.0	1.5±1.0	-
	151K~391K			
	431K~621K			
	681K~911K			
	102K~122K			
E (max.)	180K~121K	9.0	9.0	9.0
	151K~391K	9.8	9.8	9.8
	431K~621K	11.5	11.5	11.5
	681K~911K	13.8	13.8	13.8
	102K~122K	16.0	16.0	16.0
L (min.)		20.0	20.0	20.0
L3 (min.)		10.0	10.0	-
Φd(±0.05)		1.0		

METAL OXIDE VARISTORS

TMOV 20M(E,N)

Electrical characteristics

Part Number	Maximum Allowable Voltage		Varistor Voltage V_{1mA} (V)	Maximum Clamping Voltage		Maximum Peak Current (8/20 μ s)		Maximum Energy (Joule)		Rated Power (W)	Typical Capacitance (Reference) @1KHz (pf)
	V_{AC} (V)	V_{DC} (V)		I_P (A)	V_C (V)	1 time	2 times	10/1000 μ s	2ms		
			(A)								
180KM(E,N)20	11	14	18(15~21.6)	20	36	3000	2000	13	10	0.2	28500
220KM(E,N)20	14	18	22(19.5~26)	20	43	3000	2000	16	12	0.2	18500
270KM(E,N)20	17	22	27(24~31)	20	53	3000	2000	19	14	0.2	13000
330KM(E,N)20	20	26	33(29.5~36.5)	20	65	3000	2000	24	18	0.2	11500
390KM(E,N)20	25	31	39(35~43)	20	77	3000	2000	28	21	0.2	8500
470KM(E,N)20	30	38	47(42~52)	20	93	5000	3000	34	25	0.2	7400
560KM(E,N)20	35	45	56(50~62)	20	110	5000	3000	41	30	0.2	6500
680KM(E,N)20	40	56	68(61~75)	20	135	5000	3000	49	37	0.2	5800
820KM(E,N)20	50	65	82(74~90)	100	135	6500	4500	56	42	1.0	4900
101KM(E,N)20	60	85	100(90~110)	100	165	6500	4500	70	52	1.0	4000
121KM(E,N)20	75	100	120(108~132)	100	200	6500	4500	85	63	1.0	3300
151KM(E,N)20	95	125	150(135~165)	100	250	10000	8000	100	70	1.0	2700
181KM(E,N)20	115	150	180(162~198)	100	300	10000	8000	110	80	1.0	2200
201KM(E,N)20	130	170	200(185~225)	100	340	10000	8000	140	100	1.0	2000
221KM(E,N)20	140	180	220(198~242)	100	365	10000	8000	155	110	1.0	1800
241KM(E,N)20	150	200	240(216~264)	100	395	10000	8000	170	120	1.0	1650
271KM(E,N)20	175	225	270(243~297)	100	455	10000	8000	190	135	1.0	1500
301KM(E,N)20	190	250	300(270~330)	100	500	10000	8000	205	145	1.0	1300
331KM(E,N)20	210	275	330(297~363)	100	550	10000	8000	215	150	1.0	1200
361KM(E,N)20	230	300	360(324~396)	100	595	10000	8000	225	160	1.0	1100
391KM(E,N)20	250	320	390(351~429)	100	650	10000	8000	240	170	1.0	1000
431KM(E,N)20	275	350	430(387~473)	100	710	10000	8000	270	190	1.0	930
471KM(E,N)20	300	385	470(423~517)	100	775	10000	8000	350	250	1.0	850
511KM(E,N)20	320	415	510(459~561)	100	845	10000	8000	380	270	1.0	780
561KM(E,N)20	350	460	560(504~616)	100	920	10000	8000	400	280	1.0	710
621KM(E,N)20	385	505	620(558~682)	100	1025	10000	8000	425	300	1.0	650
681KM(E,N)20	420	560	680(612~748)	100	1120	10000	8000	435	310	1.0	600
751KM(E,N)20	460	615	750(675~825)	100	1240	10000	8000	455	327	1.0	530
781KM(E,N)20	485	640	780(702~858)	100	1290	10000	8000	461	335	1.0	510
821KM(E,N)20	510	670	820(738~902)	100	1355	10000	8000	475	344	1.0	500
911KM(E,N)20	550	745	910(819~1001)	100	1500	10000	8000	500	350	1.0	440
102KM(E,N)20	625	825	1000(900~1100)	100	1650	10000	8000	560	400	1.0	400
112KM(E,N)20	680	895	1100(990~1210)	100	1815	10000	8000	610	430	1.0	360
122KM(E,N)20	750	990	1200(1080~1320)	100	1980	10000	8000	650	460	1.0	320

Notes: Leakage Current (@83% of V_{1mA}): $I_R \leq 50\mu A$ (180K~680K) ; $I_R \leq 35\mu A$ (820K~122K).

Electrical Ratings

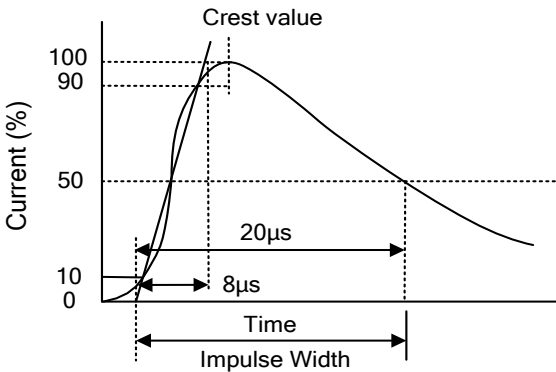
Items	Test Condition/Description	Requirement
Varistor Voltage	The voltage between two terminals with the specified measuring current 1mA.DC applied is called Vb.	
Maximum Allowable Voltage	The recommended maximum sine wave voltage (RMS) or the Maximum DC voltage can be applied continuously.	
Maximum Clamping Voltage	<p>The maximum voltage between two terminals with the specification standard impulse current. Applied waveform: 8/20µs</p> 	To meet the Specified value
Rated Wattage	The maximum average power that can be applied within the specified ambient temperature.	
Energy	The maximum energy within the varistor voltage change of ±10% when one impulse of 10/1000µs or 2ms is applied.	
Withstanding Surge Current	The maximum current within the varistor voltage change of ±10% with the standard impulse current (8/20µs) applied one time.	
Varistor Voltage Temp. Coefficient	$\left \frac{V_{1mA@85^{\circ}C} - V_{1mA@25^{\circ}C}}{V_{1mA@25^{\circ}C}} \times \frac{1}{60} \times 100\% (\%/^{\circ}C) \right $	≤0.05%/°C
	$\left \frac{V_{1mA@-40^{\circ}C} - V_{1mA@25^{\circ}C}}{V_{1mA@25^{\circ}C}} \times \frac{1}{65} \times 100\% (\%/^{\circ}C) \right $	

Mechanical Characteristics

Items	Test conditions / Methods	Specifications								
Tensile Strength of Terminals	Gradually applying the force specified and keeping the unit fixed for 10±1 sec. <table border="1"> <thead> <tr> <th>Terminal diameter (mm)</th> <th>Force (kg)</th> </tr> </thead> <tbody> <tr> <td>0.5<d≤0.8</td> <td>1.0</td> </tr> <tr> <td>0.8<d≤1.25</td> <td>2.0</td> </tr> <tr> <td>1.25<d</td> <td>4.0</td> </tr> </tbody> </table>	Terminal diameter (mm)	Force (kg)	0.5<d≤0.8	1.0	0.8<d≤1.25	2.0	1.25<d	4.0	No visible damage ΔV _{1mA} /V _{1mA} ≤5%
Terminal diameter (mm)	Force (kg)									
0.5<d≤0.8	1.0									
0.8<d≤1.25	2.0									
1.25<d	4.0									
Bending Strength of Terminals	Hold specimen and apply the force specified below to each lead. Bend the specimen to 90°, then return to the original position. Repeat the procedure in the opposite direction. <table border="1"> <thead> <tr> <th>Terminal diameter (mm)</th> <th>Force (kg)</th> </tr> </thead> <tbody> <tr> <td>0.5<d≤0.8</td> <td>0.5</td> </tr> <tr> <td>0.8<d≤1.25</td> <td>1.0</td> </tr> <tr> <td>1.25<d</td> <td>2.0</td> </tr> </tbody> </table>	Terminal diameter (mm)	Force (kg)	0.5<d≤0.8	0.5	0.8<d≤1.25	1.0	1.25<d	2.0	No visible damage ΔV _{1mA} /V _{1mA} ≤5%
Terminal diameter (mm)	Force (kg)									
0.5<d≤0.8	0.5									
0.8<d≤1.25	1.0									
1.25<d	2.0									
Vibration	Frequency range: 10~55 Hz Amplitude: 0.75mm or 98m/s ² Direction: 3 mutually perpendicular directions, 2hrs each.	No visible damage ΔV _{1mA} /V _{1mA} ≤5%								
Solder ability	Solder Temp: 245±5°C Dipping Time: 2±0.5 sec	At least 95% of terminal electrode is covered by new solder								
Resistance to Soldering Heat	Solder Temp: 260±5°C Dipping Time: ≤10 sec	No visible damage ΔV _{1mA} /V _{1mA} ≤10%								

Reliability

Items	Test conditions / Methods	Specifications															
High Temperature Storage	Ambient Temp: 85±2°C Duration: 1000hrs	ΔV _{1mA} /V _{1mA} ≤5%															
Low Temperature Storage	Ambient Temp: -40±2°C Duration: 1000hrs	ΔV _{1mA} /V _{1mA} ≤5%															
Humidity	Ambient Temp: 40±2°C, 90~95% R.H. Duration: 1000hrs	ΔV _{1mA} /V _{1mA} ≤5%															
Temperature Cycle	The conditions shown below shall be repeated 5 cycles <table border="1"> <thead> <tr> <th>Step</th> <th>Temperature (°C)</th> <th>Period (minutes)</th> </tr> </thead> <tbody> <tr> <td>1</td> <td>-40±3</td> <td>30±3</td> </tr> <tr> <td>2</td> <td>Room temperature</td> <td>15±3</td> </tr> <tr> <td>3</td> <td>85±3</td> <td>30±3</td> </tr> <tr> <td>4</td> <td>Room temperature</td> <td>15±3</td> </tr> </tbody> </table>	Step	Temperature (°C)	Period (minutes)	1	-40±3	30±3	2	Room temperature	15±3	3	85±3	30±3	4	Room temperature	15±3	No visible damage ΔV _{1mA} /V _{1mA} ≤5%
Step	Temperature (°C)	Period (minutes)															
1	-40±3	30±3															
2	Room temperature	15±3															
3	85±3	30±3															
4	Room temperature	15±3															
High Temperature Load	Ambient Temp: 85±2°C Duration: 1000hrs Load: Max. Allowable Voltage In AC eara.	ΔV _{1mA} /V _{1mA} ≤10%															
Damp Heat Load	Ambient Temp: 40±2°C, 90~95% R.H. Duration: 1000hrs Load: Max. Allowable Voltage	No visible damage ΔV _{1mA} /V _{1mA} ≤10%															
Voltage Proof	Metal balls method, 2500Vac 1 min.	No visible damage															

Maximum Leakage Current and Maximum Clamping Voltage Curve

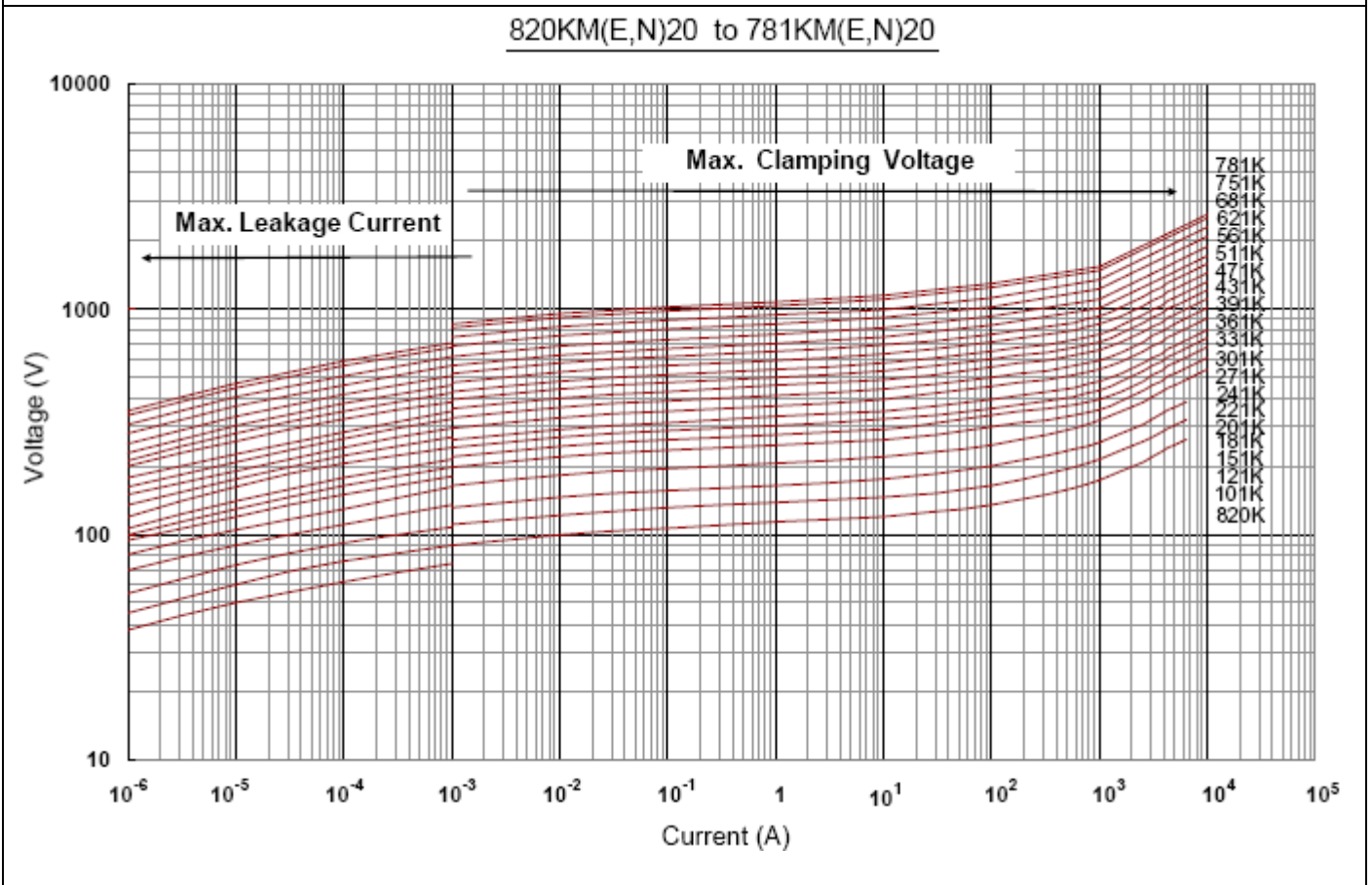
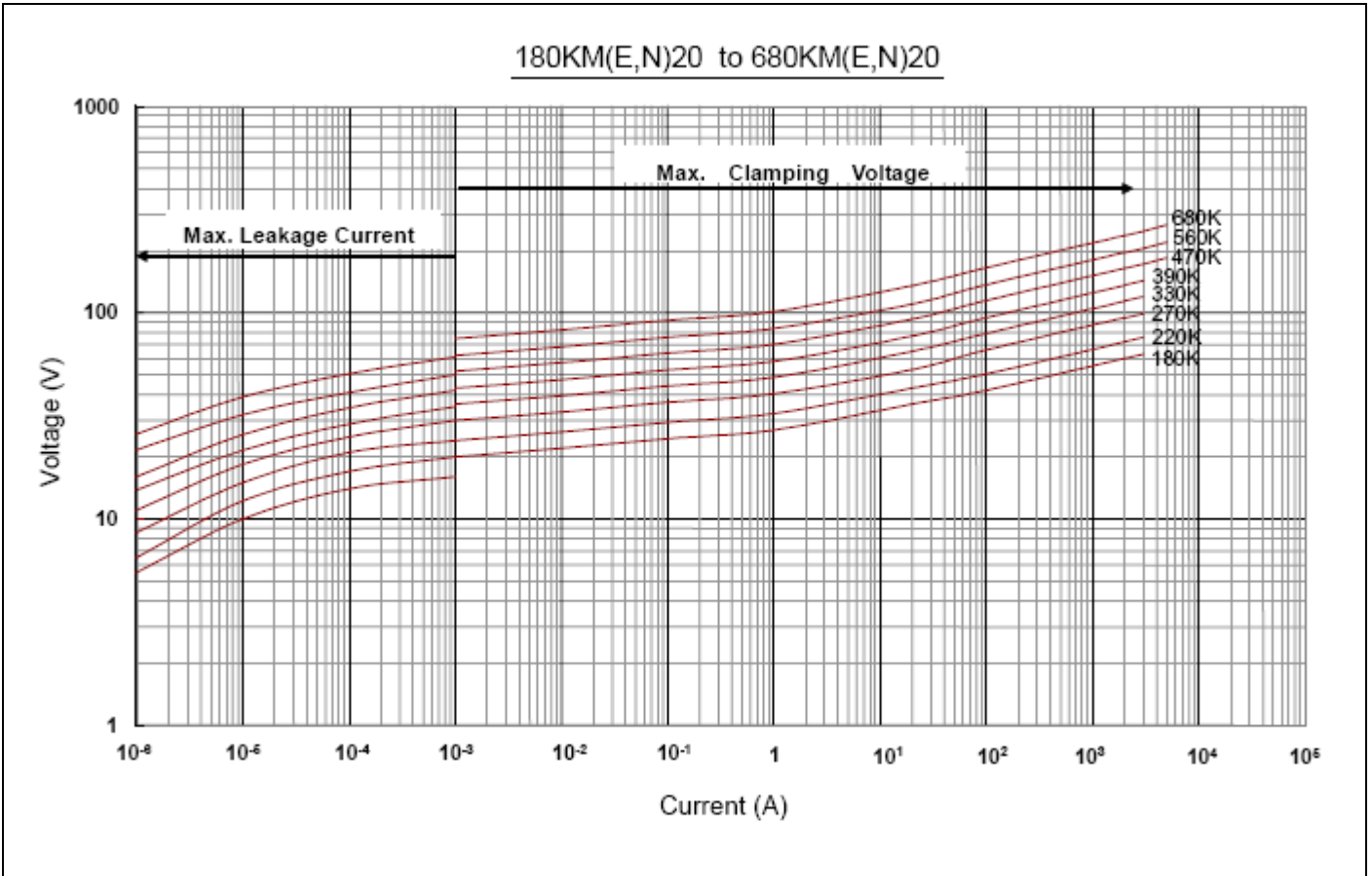

Maximum Leakage Current and Maximum Clamping Voltage Curve

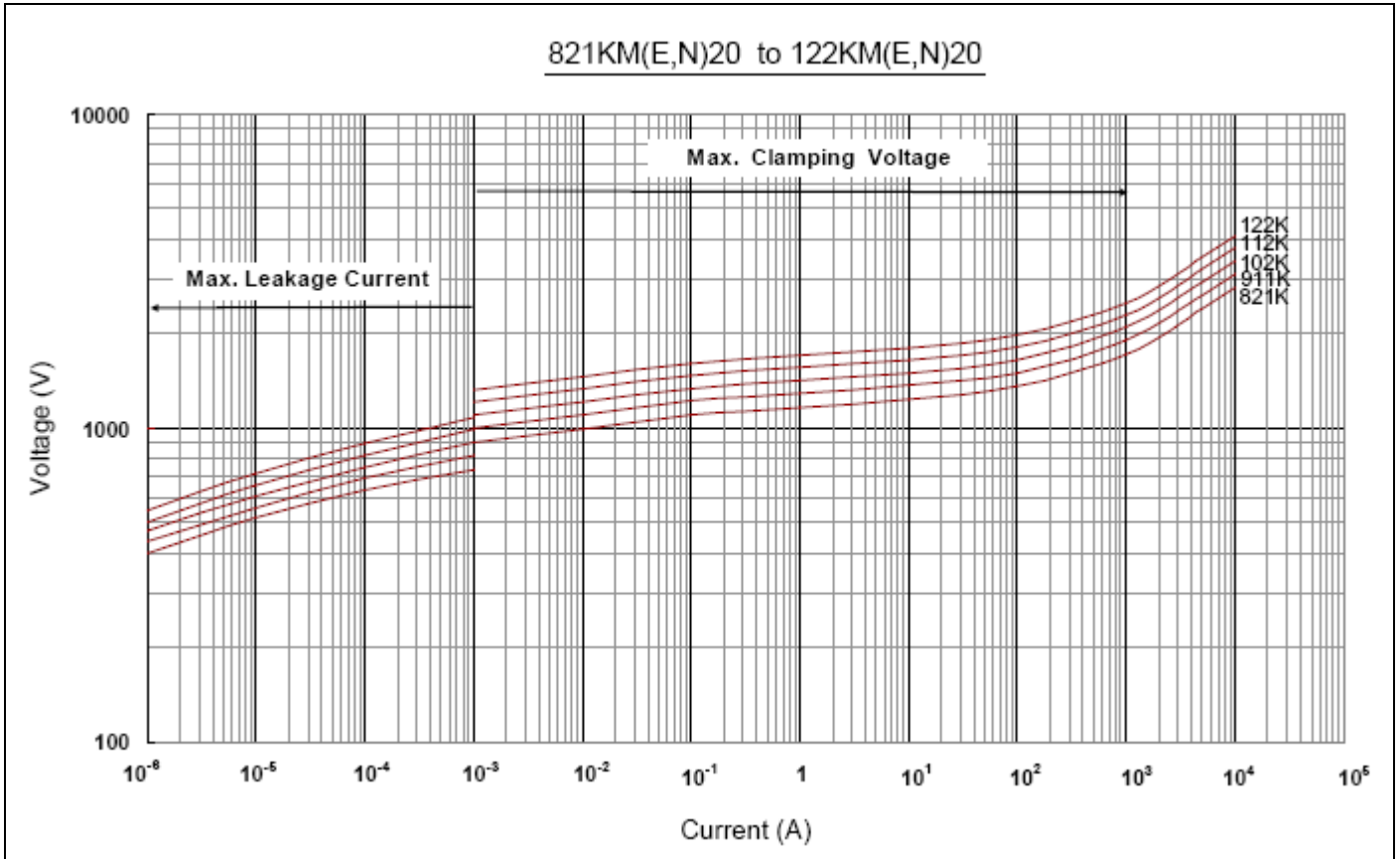

Maximum Surge Current Derating Curve

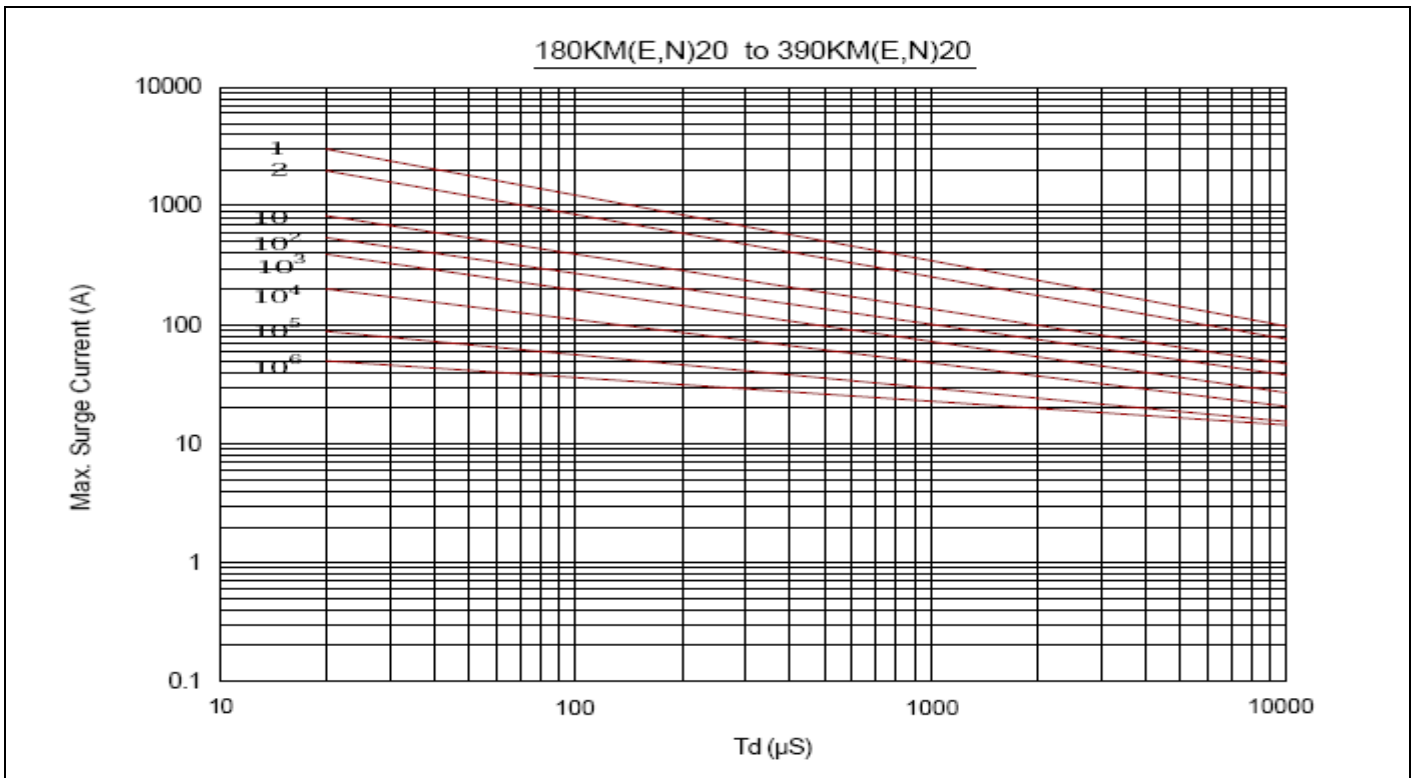

Maximum Surge Current Derating Curve

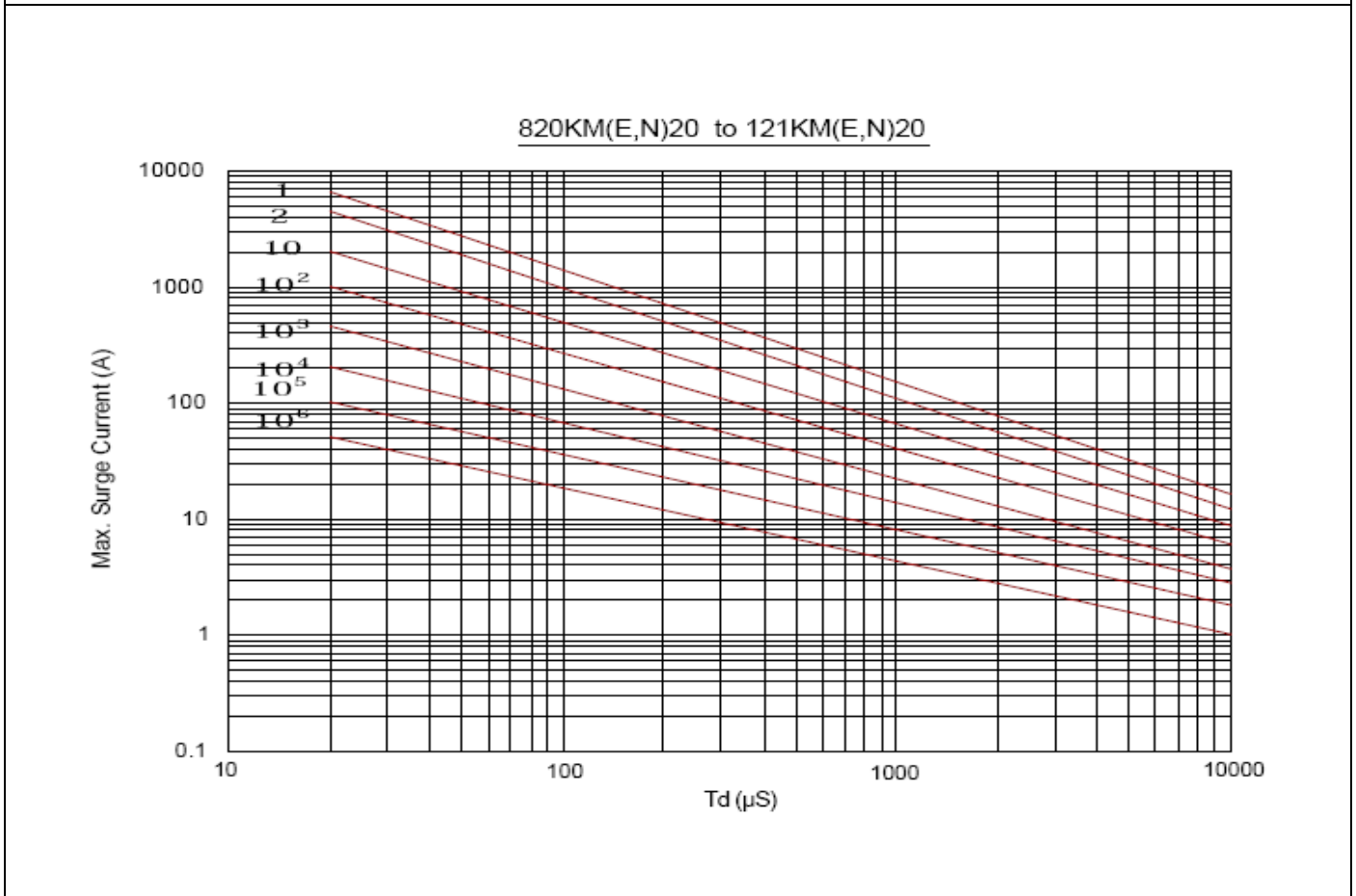
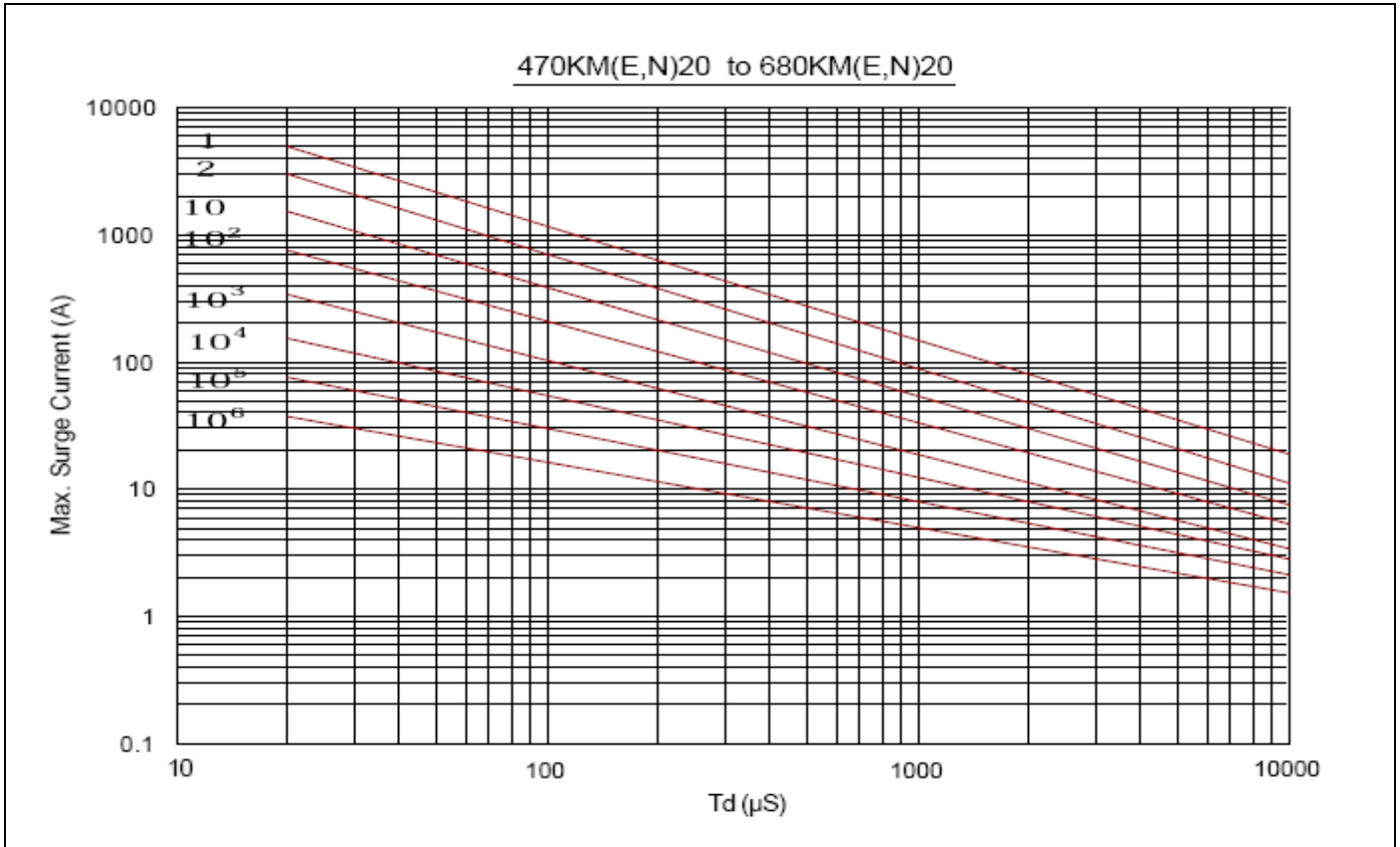

Maximum Surge Current Derating Curve

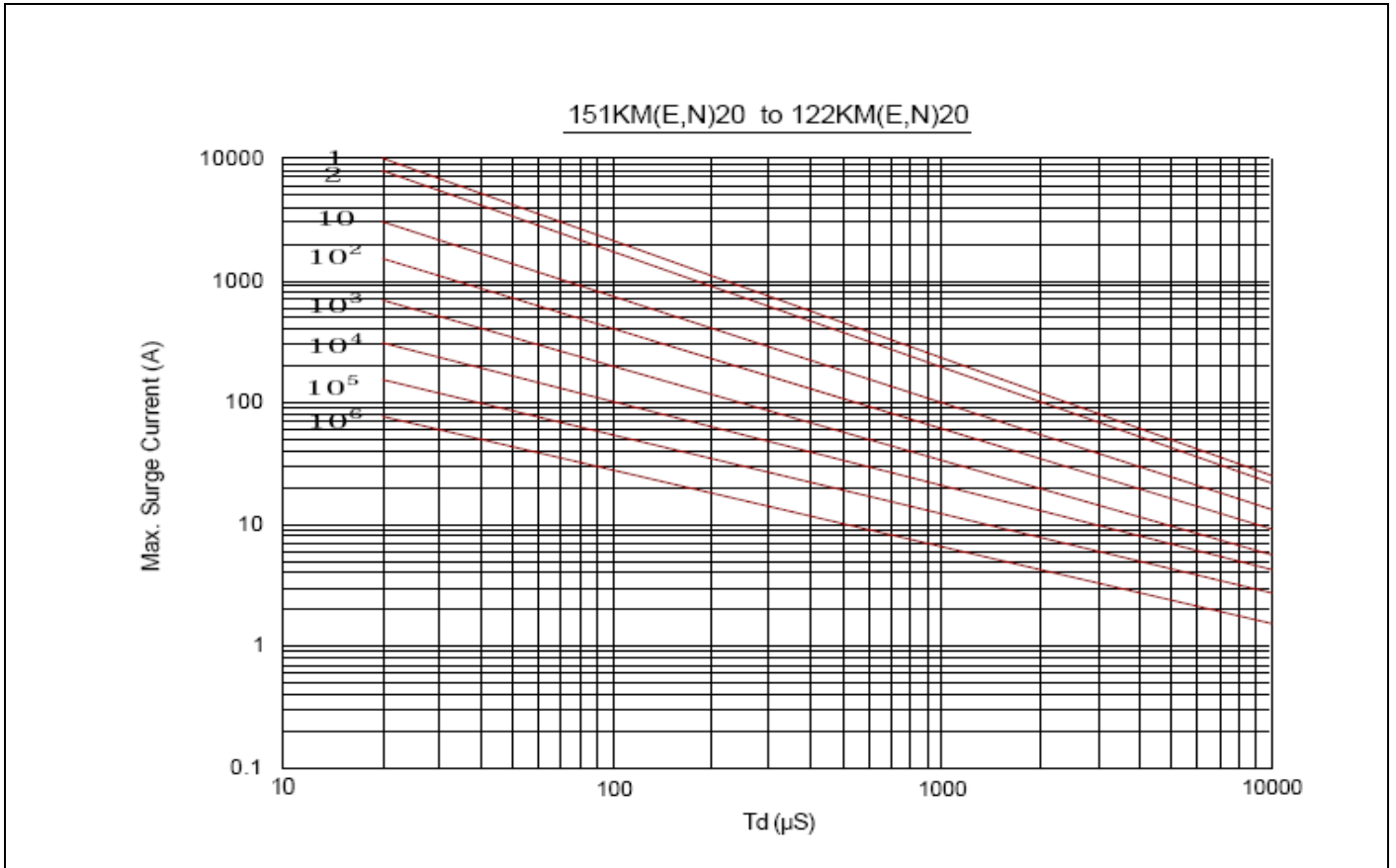

Soldering Recommendation

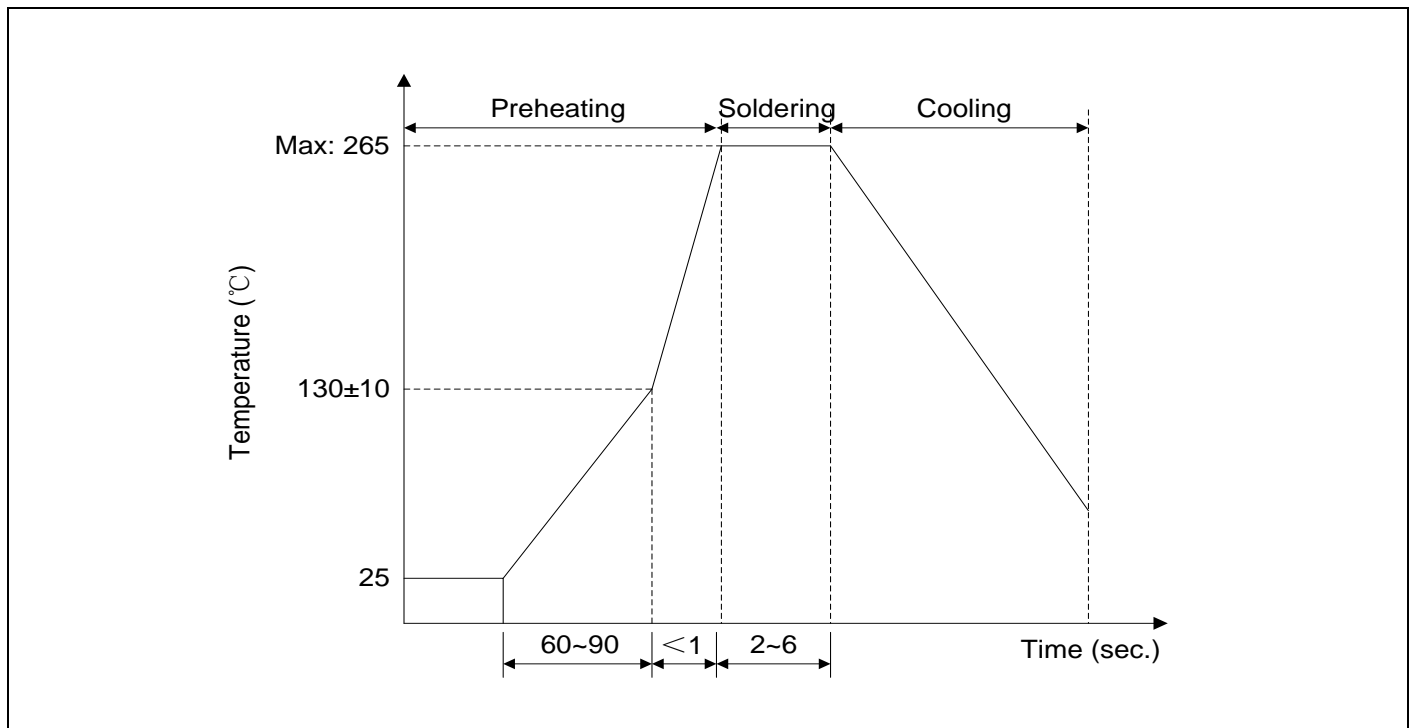

Marking code

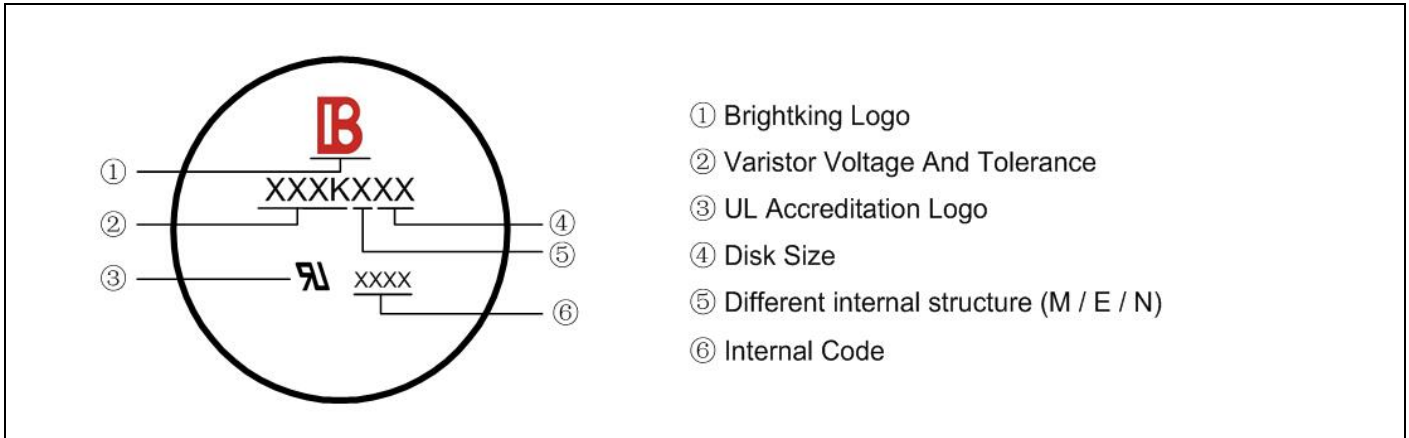

Soldering Recommendation

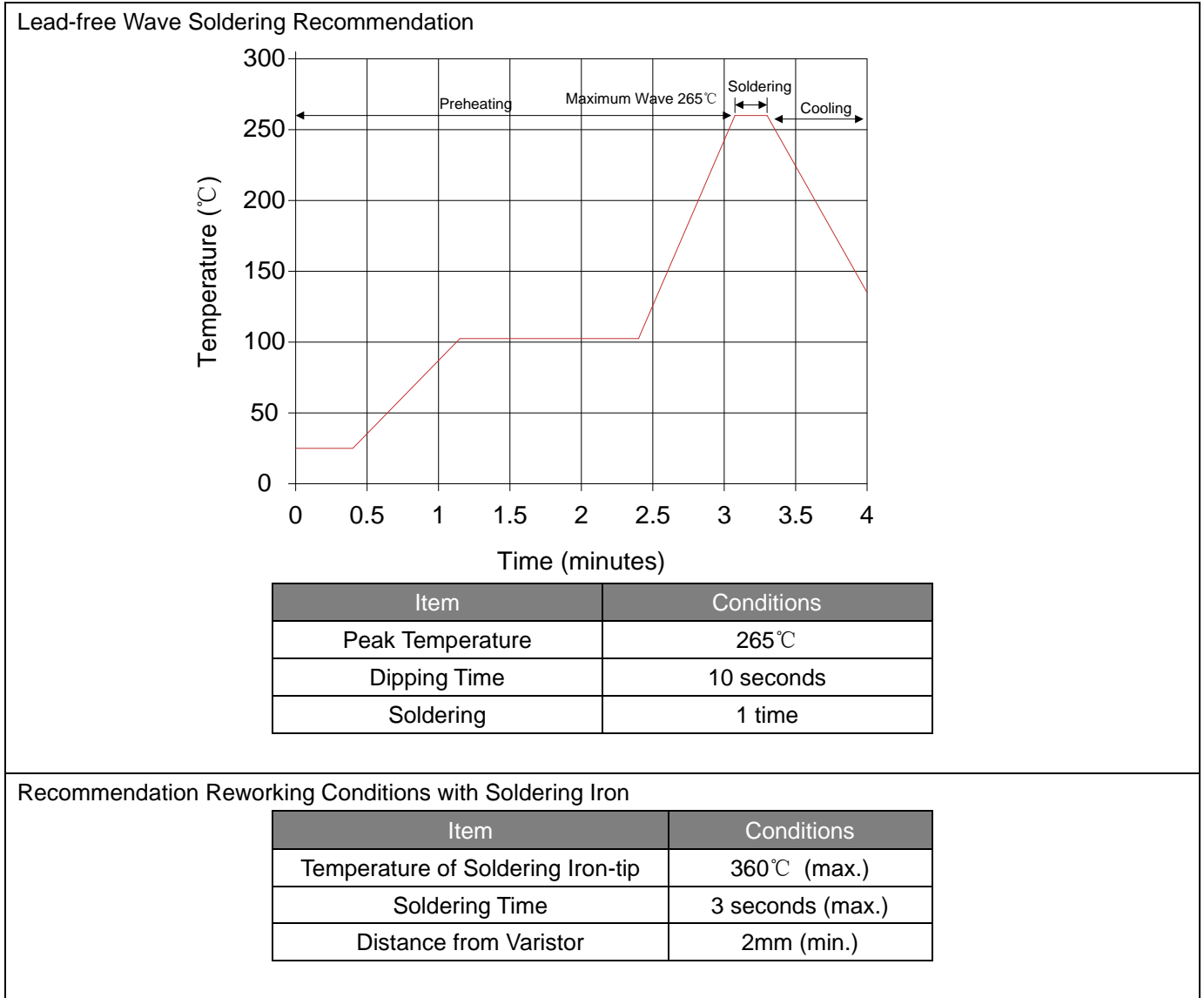

Quantity

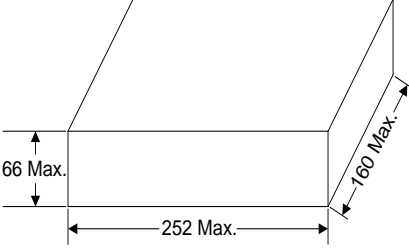
Packaging Dimensions (Unit: mm)	Quantity
<p data-bbox="108 295 167 324">Bulk</p>  <p data-bbox="443 510 507 539">66 Max.</p> <p data-bbox="603 568 699 598">252 Max.</p> <p data-bbox="794 450 858 568">160 Max.</p>	<p data-bbox="1281 488 1425 562">100pcs/bag 2bags/box</p>

单击下面可查看定价，库存，交付和生命周期等信息

[>>Brightking\(君耀电子\)](#)