

BCT3140

1000mA Buck/Boost Charge Pump LED Driver

GENERAL DESCRIPTION

The BCT3140 is a current-regulated charge pump ideal for powering high brightness LEDs for camera flash applications. The charge pump can be set to regulate two current levels for FLASH and TORCH modes.

The BCT3140 automatically switches modes between step-up and step-down ensuring that LED current does not depend on the forward voltage. It switches at 1.5MHz, allowing the use of tiny components. The supply voltage ranges from 2.7V to 5.5V and is ideally suited for all applications powered by a single LI-Ion battery cell or three to four NiCd, NiMH, or Alkaline battery cells.

The BCT3140 also features a very low shutdown current, an automatic soft-start mode to limit inrush current, as well as over current, over voltage and over thermal shutdown control. A low current sense reference voltage (47mV) allows the use of small 0603 current sensing resistors.

The BCT3140 is available in Green DFN3x3-10L package and is specified over an ambient temperature range of -40°C to +85°C.

ORDERING INFORMATION

Order Number	Package Type	Temperature Range	Marking	QTY/Reel
BCT3140EGG-TR	DFN3x3-10L	-40°C to +85°C	 X X X X X 3140	3000

Note: "XXXXX" in Marking will be appeared as the batch code.

FEATURES

- Output Current up to 1000mA
- Up to 90% Efficiency in Torch Mode
- Adjustable FLASH Mode Current
- 1x and 2x Automatic Modes for High Efficiency
- Input Voltage Range: 2.7V to 5.5V
- Minimum External Components: No Inductors
- High Frequency Operation: 1.5MHz
- Low 47mV Reference For Low Loss Sensing
- Built-In Soft Start Limits Inrush Current
- Low Input and Output Ripple and Low EMI
- Output Over Voltage Protection
- Over-current and Over-temperature Protection
- Available in Green DFN3x3-10L Package

APPLICATIONS

White LED Torch, Flash for Cell Phones, DSCs and Camcorders
 White LED Backlighting
 Generic Lighting, Flash and Strobe Applications
 General Purpose High Current Boost

TYPICAL OPERATING CIRCUIT

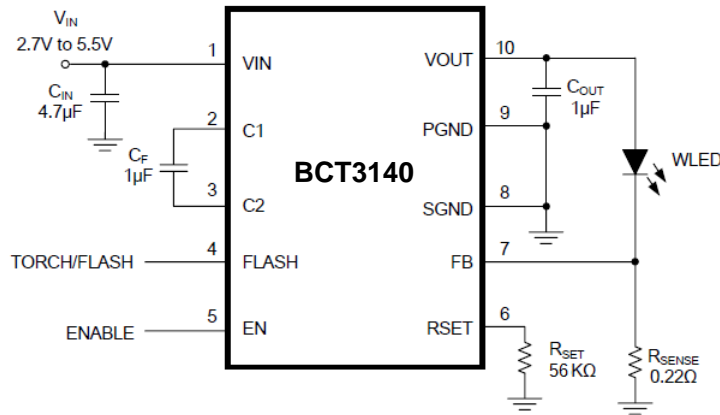

ABSOLUTE MAXIMUM RATINGS

V_{IN}, V_{OUT}	-0.3V to 6V
V_{EN}	0V to 5.5V
Output Current Pulse (Flash).....	1A
Output Current Continuous (Torch).....	0.4A
Package Thermal Resistance	
DFN3x3-10L, θ_{JA}	57°C/W
Storage Temperature Range.....	-40°C to +150°C
Junction Temperature.....	150°C
Operating Temperature Range.....	-40°C to +85°C
Lead Temperature (Soldering, 10 sec).....	260°C
ESD Susceptibility	
HBM.....	2000V
MM.....	200V

NOTE:

Stresses beyond those listed under "Absolute Maximum Ratings" may cause permanent damage to the device. These are stress ratings only, and functional operation of the device at these or any other conditions beyond those indicated in the operational sections of the specifications is not implied. Exposure to absolute maximum rating conditions for extended periods may affect device reliability.

CAUTION

This integrated circuit can be damaged by ESD if you don't pay attention to ESD protection. Broadchip recommends that all integrated circuits be handled with appropriate precautions. Failure to observe proper handling and installation procedures can cause damage. ESD damage can range from subtle performance degradation to complete device failure. Precision integrated circuits may be more susceptible to damage because very small parametric changes could cause the device not to meet its published specifications.

Broadchip reserves the right to make any change in circuit design, specification or other related things if necessary without notice at any time. Please contact Broadchip sales office to get the latest datasheet.

PIN CONFIGURATION

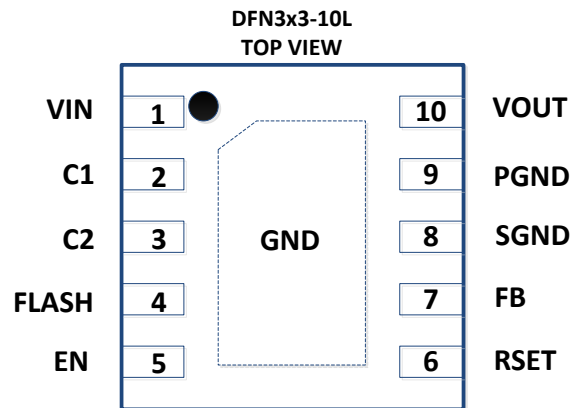

PIN DESCRIPTION

PIN	NAME	FUNCTION
1	VIN	Input voltage for the charge pump. Decouple with 4.7μF or 10μF ceramic capacitor close to the pins of the IC.
2	C1	Positive input for the external flying capacitor. Connect a ceramic 1μF capacitor close to the pins of the IC.
3	C2	Negative input for the external flying capacitor. Connect a ceramic 1μF capacitor close to the pins of the IC.
4	FLASH	Logic input to toggle operation between FLASH and TORCH mode. In TORCH mode FB is regulated to the internal 47mV reference. In FLASH mode FB reference voltage can be adjusted by changing the resistor from RSET pin to ground. Choose the external current sense resistor (R_{SENSE}) based on desired current in TORCH mode and FLASH mode.
5	EN	Shutdown control input. Connect to VIN for normal operation, connect to ground for shutdown.
6	RSET	Connect a resistor from this pin to ground. When in FLASH mode (FLASH = High) this resistor sets the current regulation point according to the following: $V_{FB} = (1.26V / R_{SET}) \times 10.2 K\Omega$
7	FB	Feedback input for the current control loop. Connect directly to the current sense resistor.
8	SGND	Internal ground pin. Control circuitry returns current to this pin.
9	PGND	Power ground pin. Flying capacitor current returns through this pin.
10	VOUT	Charge Pump Output Voltage. Decouple with an external capacitor. At least 1μF is recommended. If Higher value capacitor is used, output ripple is smaller.
Exposed Pad	GND	Exposed pad should be soldered to PCB board and connected to GND.

ELECTRICAL CHARACTERISTICS

(VIN= 3.6V, CIN=4.7uF, COUT=CF=1uF, VSHDN=VIN, TA = 25°C, unless otherwise specified.)

PARAMETER	SYM	CONDITIONS	MIN	TYP	MAX	UNITS
Input Voltage Range	V _{IN}		2.7		5.5	V
Quiescent Current	I _Q	V _{IN} =2.7V to 5.5V, FLASH=0V, I _{LOAD} =100uA		0.3		mA
		FLASH=V _{IN} , 2x Mode		2		
Shutdown Current	I _{SHDN}	V _{EN} =0V, V _{IN} =5.5V		1		uA
Oscillator Frequency				1.5		MHz
Charge Pump Equivalent Resistance (2x mode)				5		Ω
Equivalent Resistance (1x mode)				0.6		Ω
FB Reference Voltage	V _{FB}	FLASH=VIN, RSET=56KΩ		229		mV
		FLASH=GND		47		
FB Pin Current	I _{FB}	V _{FB} =0.3V			1	uA
EN, FLASH Logic Low					0.4	V
EN, FLASH Logic High			1.2			V
EN, FLASH Pin Current					1	uA
Protection Time		FLASH=V _{IN} (flash high to lout off)		1		s
VOUT Turn-on Time		V _{IN} =3.6V, FB within 90% regulation		250		us
Thermal Shutdown Temperature				145		°C

TYPICAL PERFORMANCE CHARACTERISTICS

Ripple 1X Flash 1000mA

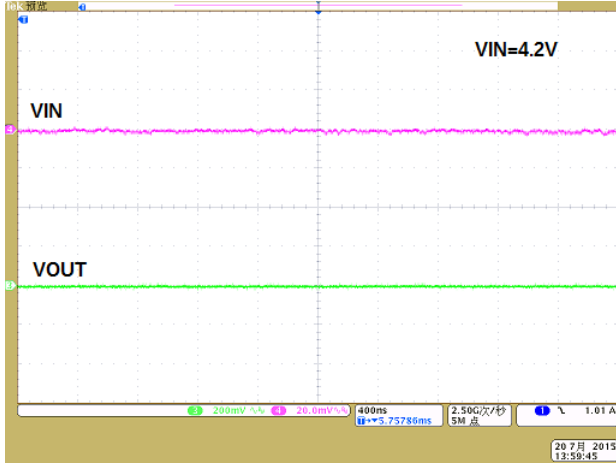

Ripple 1X Torch 200mA

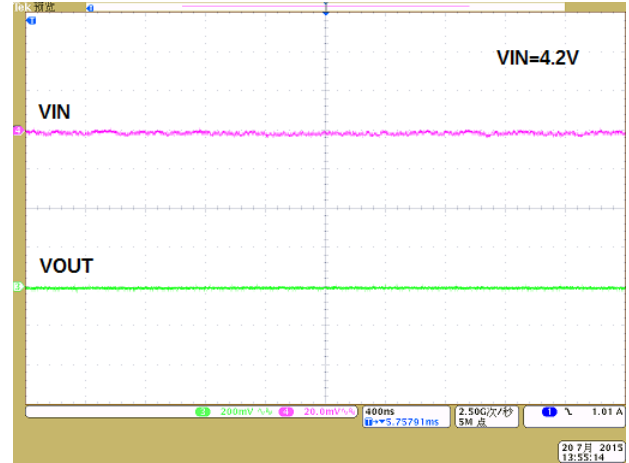

Ripple 2X Flash 1000mA



Ripple 2X Torch 200mA

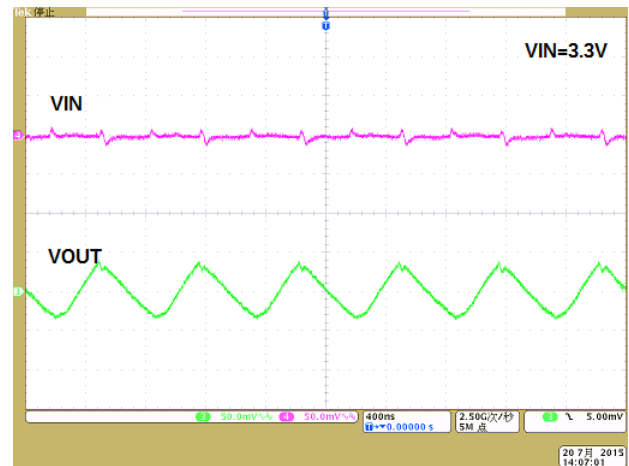

Start up 1000mA Flash

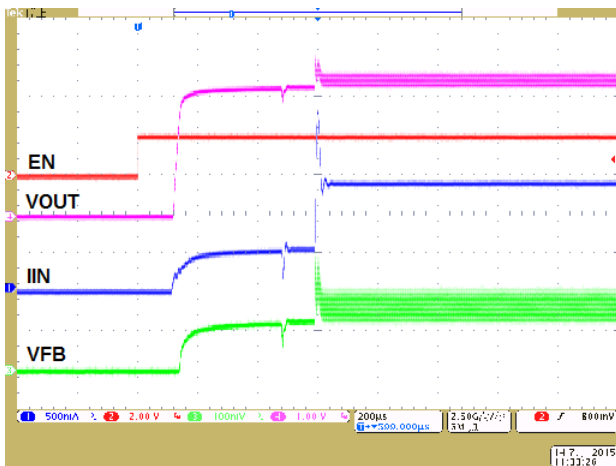

Start up 200mA Torch

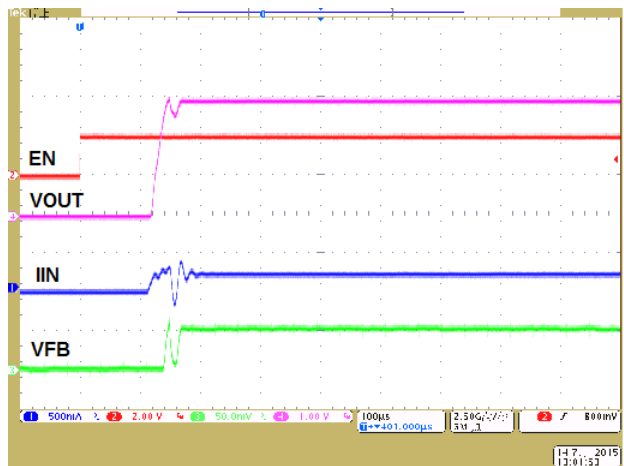

Torch in 1X to Flash in 1X Mode

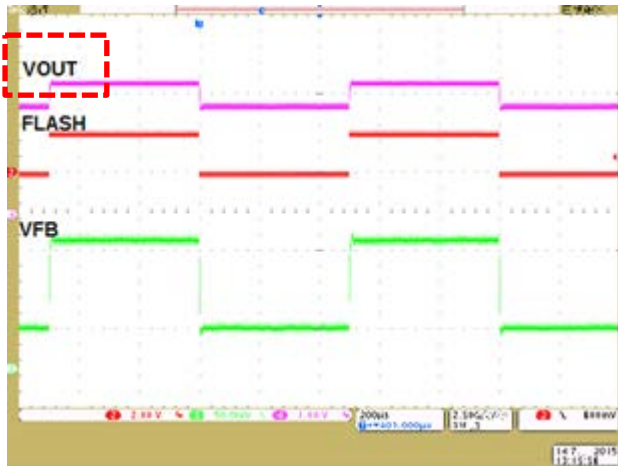

Efficiency Vs. Input Voltage

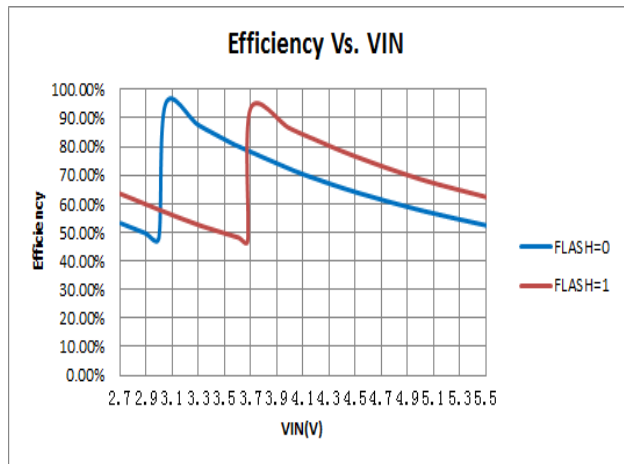

Output Current Vs. Input Voltage

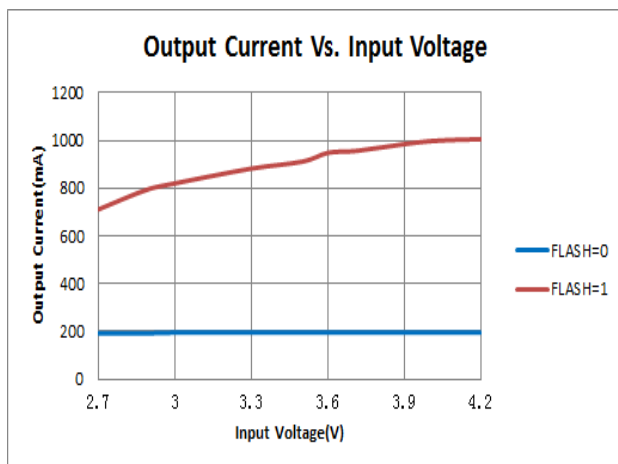

Battery Current Vs. Input Voltage

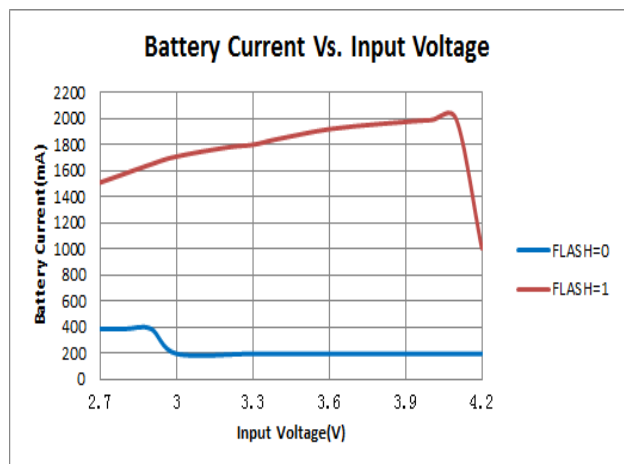

TYPICAL APPLICATION

The BCT3140 can be used with multiple LEDs in parallel as shown in figure 1. For best performance, the LEDs should be in a single package, preferably from a single die to have better matching for forward voltage V_F for a given forward current I_F . In practice, if the V_F of one LED is higher than the others, it will consume a larger I_F , which will raise its temperature which will then cause its V_F to reduce, correcting the imbalance. The overall current will be the sum of the individual currents, for example $I_{TOTAL} = 4 \times I_{LED}$.

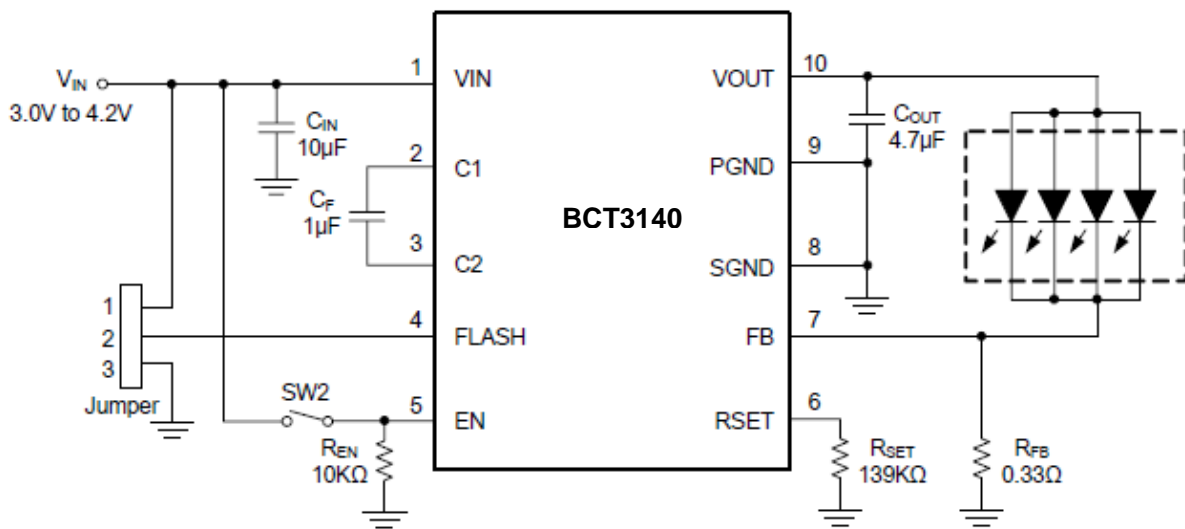

Figure 1. Multiple LEDs Flash Circuit

FUNCTIONAL DESCRIPTION

The BCT3140 is a charge pump regulator designed for converting a Li-Ion battery voltage of 2.7V to 4.2V to drive a white LED used in digital still camera Flash and Torch applications. The BCT3140 has two modes of operation which are pin selectable for either Flash or Torch. Flash mode is usually used with a pulse of about 200 to 300 milliseconds to generate a high intensity Flash. Torch can be used continuously at a lower output current than Flash and is often used for several seconds in a digital still camera "movie" mode.

The BCT3140 also has two modes of operation to control the output current: the 1x mode and 2x mode. Operation begins after the enable pin EN receives a logic high, the bandgap reference wakes up after 50 μ s, and then BCT3140 goes through a soft-start mode designed to reduce inrush current. The BCT3140 starts in the 1x mode, which acts like a linear regulator to control the output current by continuously monitoring the feedback pin FB. In 1x mode, if the BCT3140 auto detects a dropout condition, which is when the FB pin is below the regulation point for more than 15 μ s, the BCT3140 automatically switches to the 2x mode. The BCT3140 remains in the 2x mode until one of four things happens:

- 1) The enable pin EN has been toggled.
- 2) The Flash pin has changed from high to low.
- 3) V_{IN} is cycled or V_{IN} is at least 1V above V_{OUT} .
- 4) A thermal fault occurs.

The 2x mode is the charge pump mode where the output can be pumped as high as two times the input voltage, provided the output does not exceed the maximum voltage for the BCT3140, which is internally limited to about 5.5V. In the 2x mode, as in the 1x mode, the output current is

regulated by the voltage at the FB pin. where:

In the Torch mode, (Flash = "GND") the Flash pin is set to logic low and the BCT3140 FB pin regulates to 47mV output:

$$V_{FB} = 47\text{mV (Torch Mode)}$$

When in Flash mode, (Flash = "High"), the FB regulation voltage is set by the resistor R_{SET} connected between the R_{SET} pin and SGND and the equation:

$$V_{FB} = (1.26\text{V} / R_{SET}) \times 10.2\text{K}\Omega \text{ (Flash Mode)}$$

Where 1.26V is the internal bandgap reference voltage and 10.2K Ω is an internal resistance used to scale the R_{SET} current. Typical values of R_{SET} are 42K Ω to 170K Ω for a range of V_{FB} = 300mV to 75mV in Flash mode. The output current is then set in either Flash or Torch mode by the equation:

$$I_{OUT} = V_{FB} / R_{SENSE}$$

APPLICATIONS INFORMATION

Overtemperature Protection

When the temperature of BCT3140 rises above 145°C, the over temperature protection circuitry turns off the output switches to prevent damage to the device. If the temperature drops back down below 130 °C, the part automatically recovers and executes a soft start cycle.

Overvoltage Protection

The BCT3140 has over voltage protection. If the output voltage rises above the 5.5V threshold, the over voltage protection shuts off all of the output switches to prevent the output voltage from rising further. When the output decreases below 5.2V, the device resumes normal operation.

Overcurrent Protection

The over current protection circuitry monitors the average current out of the $V_{OUT} = 47mV$ (Torch Mode) pin. If the average output current exceeds approximately 1Amp, then the over current protection circuitry shuts off the output switches to protect the chip.

Component Selection

The BCT3140 charge pump circuit requires 3 capacitors: 4.7µF input, 1µF output and 1µF flying capacitors are typically recommended. For the input capacitor, a larger value of 10µF will help reduce input voltage ripple for applications sensitive to ripple on the battery voltage. All the capacitors should be surface mount ceramic for low lead inductance necessary at the 1.5MHz switching frequency of the BCT3140 and to obtain low ESR, which improves bypassing on the input and output and improves output voltage drive by reducing output resistance. Ceramic

capacitors with X5R or X7R temperature grade are recommended for most applications.

The input and output capacitors should be located as close to the VIN and VOUT pins as possible to obtain best bypassing, and the returns should be connected directly to the PGND pin or to the thermal pad ground located under the BCT3140. The flying capacitor should be located as close to the C1 and C2 pins as possible.

To obtain lower output ripple, the C_{OUT} value can be increased from 1µF to 2.2µF or 4.7µF with a corresponding decrease in output ripple. For output currents of 500mA to 700mA, the recommended C_F flying capacitor value of 1µF should be used. Output currents in Flash of 100mA to 400mA can use a 0.47µF C_F but a minimum 1µF C_{OUT} is still needed.

Resistor Selection

The sense resistor R_{SENSE} is determined by the value needed in the Torch mode for the desired output current by the equation:

$$R_{SENSE} = V_{FB} / I_{OUT} \text{ where } V_{FB} = 47mV \text{ (Torch Mode)}$$

Once the R_{SENSE} resistor has been selected for Torch mode, the V_{FB} voltage can be selected for Flash mode using the following equation:

$$V_{FB} = I_{OUT} \times R_{SENSE} \text{ (Flash Mode) where } I_{OUT} \text{ is for Flash Mode.}$$

Next, the R_{SET} resistor can be selected for Flash mode using the following equation:

$$R_{SET} = (1.26V / V_{FB}) \times 10.2K\Omega \text{ (Flash Mode)}$$

For an example of 190mA Torch mode and 600mA Flash mode, the values $R_{SENSE} = 0.25\Omega$, $V_{FB} = 150mV$ (Flash Mode), and $R_{SET} = 86.6K\Omega$ are calculated. The power obtained in the Flash mode would be:

$$P_{FLASH} = V_{FB} \times I_{OUT} = 150mV \times 600mA = 90mW.$$

The typical 0603 surface mount resistor is rated 1/10 Watt continuous power and 1/5 Watt pulsed



BCT3140

1000mA Buck/Boost Charge Pump LED Driver

power, more than enough for this application. For other applications, the P_{FLASH} power can be calculated and resistor size selected. The R_{SENSE} resistor is recommended to be size 0603 for most applications.

are shown here in Table 1.

The range of typical resistor values and sizes

Table1. Resistor values and sizes

PART REFERENCE	VALUE	TOLERANCE	SIZE	MANUFACTURERS
R_{SET}	68K Ω	5%	0402	ANY
R_{SET}	75K Ω	5%	0402	ANY
R_{SET}	82K Ω	5%	0402	ANY
R_{SET}	91K Ω	5%	0402	ANY
R_{SET}	100K Ω	5%	0402	ANY
R_{SET}	110K Ω	5%	0402	ANY
R_{SET}	120K Ω	5%	0402	ANY
R_{SET}	130K Ω	5%	0402	ANY
R_{SET}	140K Ω	5%	0402	ANY
R_{SET}	150K Ω	5%	0402	ANY
R_{SENSE}	0.22 Ω	5%	0603	Panasonic or Vishay
R_{SENSE}	0.27 Ω	5%	0603	Panasonic or Vishay
R_{SENSE}	0.22 Ω	5%	0603	Panasonic or Vishay
R_{SENSE}	0.33 Ω	5%	0603	Panasonic or Vishay
R_{SENSE}	0.39 Ω	5%	0603	Panasonic or Vishay
R_{SENSE}	0.47 Ω	5%	0603	Panasonic or Vishay

PACKAGE OUTLINE DIMENSIONS

DFN3x3-10L

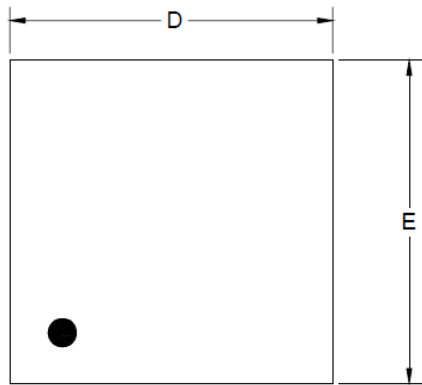

TOP VIEW

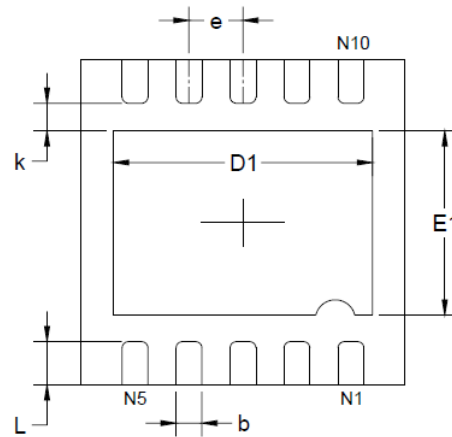

BOTTOM VIEW

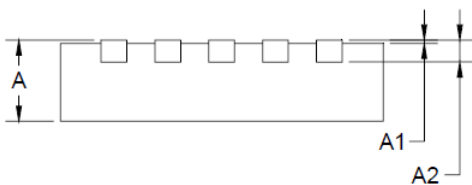

SIDE VIEW

Symbol	Dimensions In Millimeters		Dimensions In Inches	
	Min	Max	Min	Max
A	0.700	0.800	0.028	0.031
A1	0.000	0.050	0.000	0.002
A2	0.203 REF		0.008 REF	
D	2.900	3.100	0.114	0.122
D1	2.300	2.500	0.091	0.098
E	2.900	3.100	0.114	0.122
E1	1.600	1.800	0.063	0.071
k	0.200 MIN		0.008 MIN	
b	0.180	0.300	0.007	0.012
e	0.500 TYP		0.020 TYP	
L	0.300	0.500	0.012	0.020

单击下面可查看定价，库存，交付和生命周期等信息

[>>Broadchip\(广芯电子\)](#)