



Specification for Approval

- DEVICE NUMBER: BPC-10XX
- CUSTOMER:

**SAMPLES
ATTACHED AREA**

DATE	PAGE								CONTENTS
	1	2	3	4	5	6	7		
2018/4/11	1.0	1.0	1.0	1.0	1.0	1.0	1.0		Initial Released
2018/11/10	1.1								Add UL&VDE&CQC Certificate Number

FOR CUSTOMER'S APPROVAL STAMP OR SIGNATURE

APPROVED	PURCHASE	MANUFACTURE	QUALITY	ENGINEERING

佰鴻工業股份有限公司
 BRIGHT LED ELECTRONICS CORP.
 新北市板橋區和平路 19 號 3 樓
 3F., No.19, He Ping Road,
 Ban Qiao Dist., New Taipei City,
 Taiwan
 Tel: +886-2-29591090
 Fax: +886-2-29547006/29558809
www.brtled.com

ISSUED	APPROVED	PREPARED

● Features:

1. Current transfer ratio:
(CTR:50~600% at $I_F=5\text{mA}$, $V_{CE}=5\text{V}$)
2. High input-output isolation voltage
($V_{iso}=5,000\text{Vrms}$)
3. Creepage distance >8mm
4. Long Mini-flat package:2.3mm profile
5. UL/CUL approved:E236324
6. VDE approved:40007240
7. CQC approved:CQC18001204187
8. This product doesn't contain restriction substance, comply RoHS standard

● Description

1. The BPC-10XX series are optically coupled isolators containing a infrared emitting diode and an NPN silicon phototransistor
2. The lead pitch is 2.54mm

● Applications:

1. Programmable controllers.
2. System appliances, measuring instruments.
3. Hybrid substrates that require high density mounting
4. Telecommunication equipments
5. Fast charger
6. Electric home appliances, such as fan heaters, etc.
7. Signal transmission between circuits of different potentials and impedances.

● Outline Dimensions

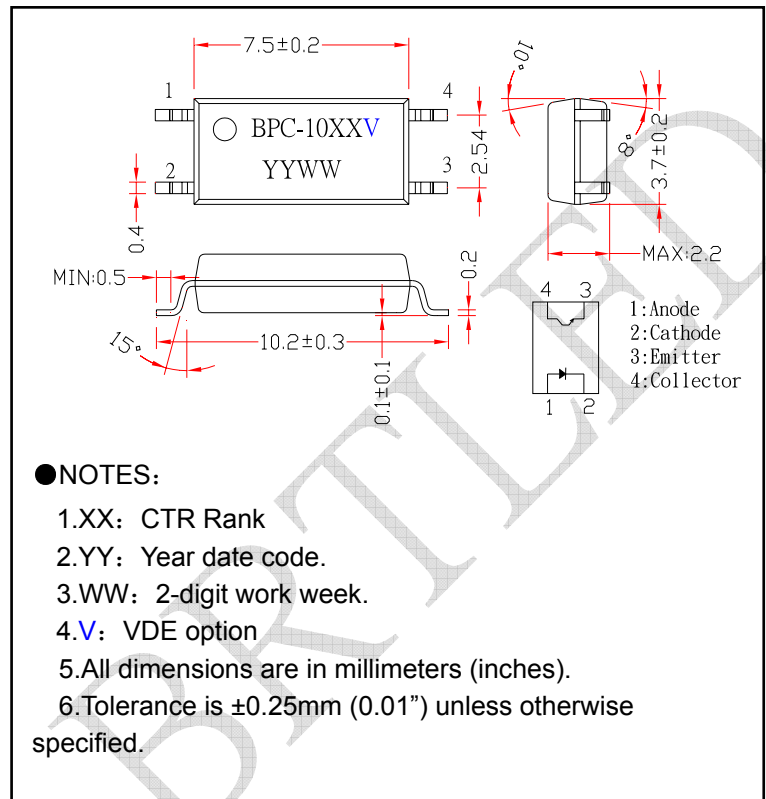

● Absolute Maximum Ratings (Ta=25°C)

Parameter		Symbol	Rating	Unit
INPUT	Forward Current	I_F	60	mA
	Reverse Voltage	V_R	6	V
	Power Dissipation	P	100	mW
OUTPUT	Collector-Emitter Voltage	V_{CEO}	80	V
	Emitter- Collector Voltage	V_{ECO}	7	
	Collector Current	I_C	50	mA
	Collector Power Dissipation	P_C	150	mW
Total Power Dissipation		P_{tot}	250	mW
*1 Isolation Voltage		V_{iso}	5,000	Vrms
Operating Temperature		T_{opr}	-30 to + 110	°C
Storage Temperature		T_{stg}	-55 to + 125	
*2 Soldering Temperature		T_{sol}	260	

*1. AC For minute, R.H. =40~60%

Isolation voltage shall be measured using the following method.

- (1) Short between anode and cathode on the primary side and between collector and emitter on the secondary side.
- (2) The isolation voltage tester with zero-cross circuit shall be used.
- (3) The waveform of applied voltage shall be a sine wave.

*2. For 10 Seconds



● Electro-Optical Characteristics (Ta=25°C)

Parameter		Symbol	Conditions	MIN.	TYP.	MAX.	Unit
INPUT	Forward Voltage	V_F	$I_F=50mA$	---	1.25	1.5	V
	Reverse Current	I_R	$V_R=6V$	---	---	10	μA
	Terminal Capacitance	C_t	$V=0, f=1KHz$	---	50	---	pF
OUTPUT	Collector Dark Current	I_{CEO}	$V_{CE}=20V, I_F=0$	---	---	100	nA
	Collector-Emitter Breakdown Voltage	BV_{CEO}	$I_C=0.1mA$ $I_F=0$	80	---	---	V
	Emitter-Collector Breakdown Voltage	BV_{ECO}	$I_E=100\mu A$ $I_F=0$	7	---	---	V
TRANSFER CHARACTERISTICS	Collector Current	I_c	$I_F=5mA$	2.5	---	30	mA
	*1 Current Transfer Ratio	CTR	$V_{CE}=5V$	50	---	600	%
	Collector-Emitter Saturation Voltage	$V_{CE(sat)}$	$I_F=10mA$ $I_C=1mA$	---	---	0.3	V
	Isolation Resistance	R_{iso}	DC500V 40~60%R.H.	5×10^{10}	1×10^{11}	---	Ω
	Floating Capacitance	C_f	$V=0, f=1MHz$	---	0.6	1	pF
	Response Time(Rise)	t_r	$V_{CE}=2V, I_C=2mA$	---	---	18	μs
	Response Time(Fall)	t_f	$R_L=100\Omega$	---	---	18	μs

*1 CTR= $I_c / I_F \times 100\%$

● RANK TABLE OF CURRENT TRANSFER RATIO(CTR)

CTR Rank	Min	Typ	Max	Unit	Condition
BPC-1000	50	-	600	%	$I_F=5mA, V_{CE}=5V$
BPC-1007	80	-	160		
BPC-1008	130	-	260		
BPC-1009	200	-	400		
BPC-1002	22	-	-	%	$I_F=1mA, V_{CE}=5V$
BPC-1003	34	-	-		
BPC-1014	56	-	-		
BPC-1002	63	-	125	%	$I_F=10mA, V_{CE}=5V$
BPC-1003	100	-	200		
BPC-1014	160	-	320		

● Characteristics Curves

Figure1. P_{tot} vs TA

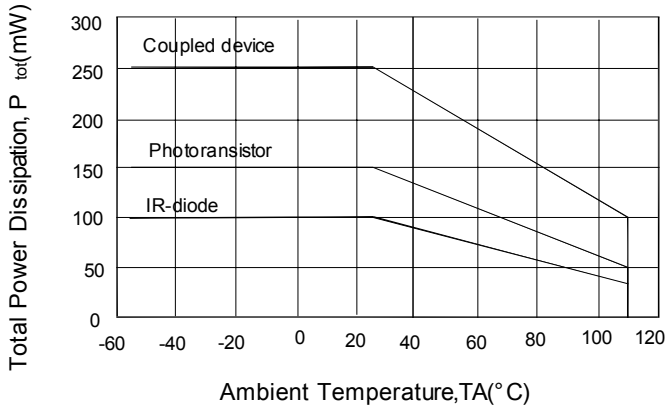

Figure2. I_F vs V_F

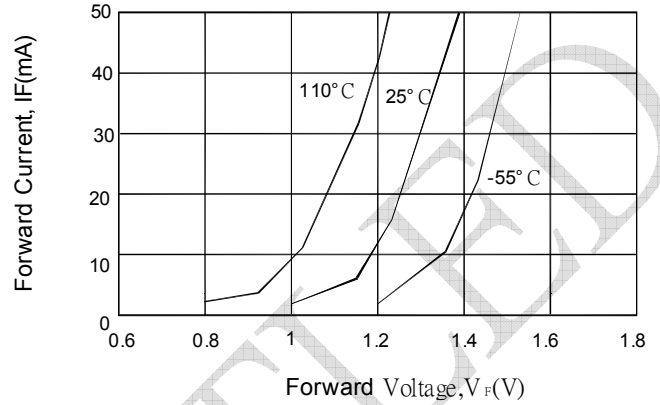

Figure3. Saturated Normalized CTR vs. TA

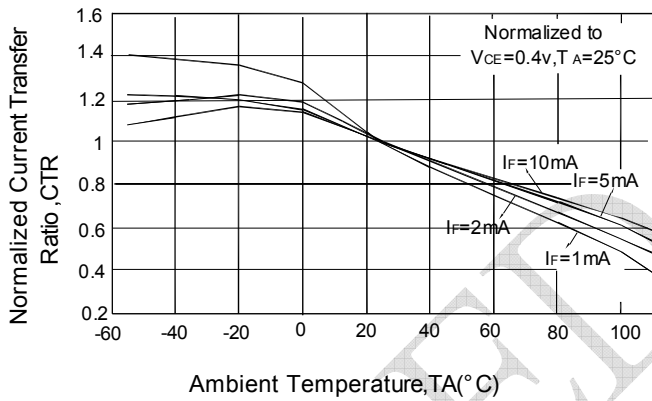

Figure4. Normalized I_C vs. I_F

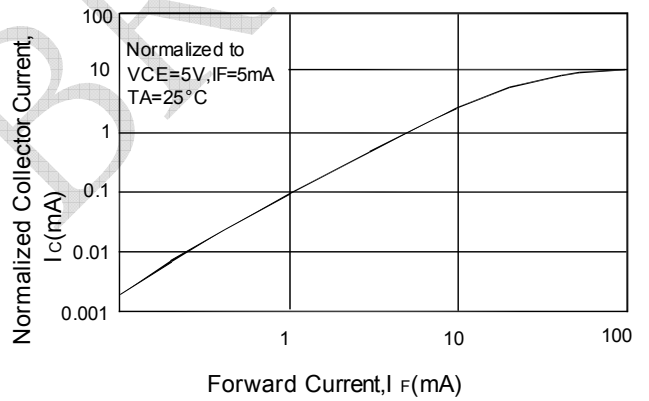

Figure5. Non-Saturated Normalized CTR vs. TA

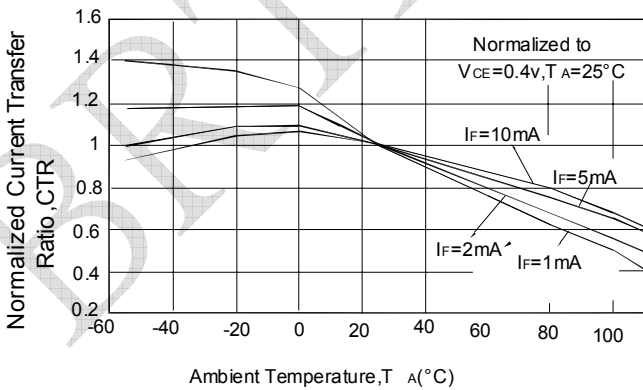

Figure6. Normalized I_C vs. I_F

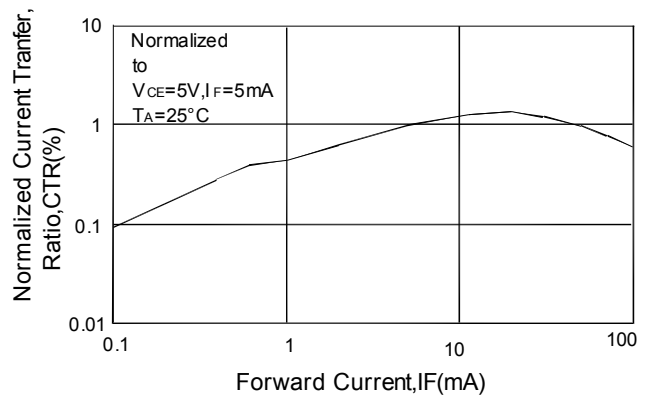

Figure7. I_{CEO} vs. T_A

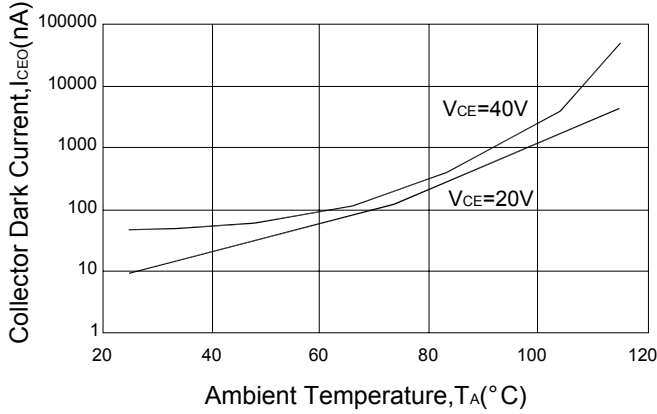

Figure8. T_{ON}/T_{OFF} vs. I_F

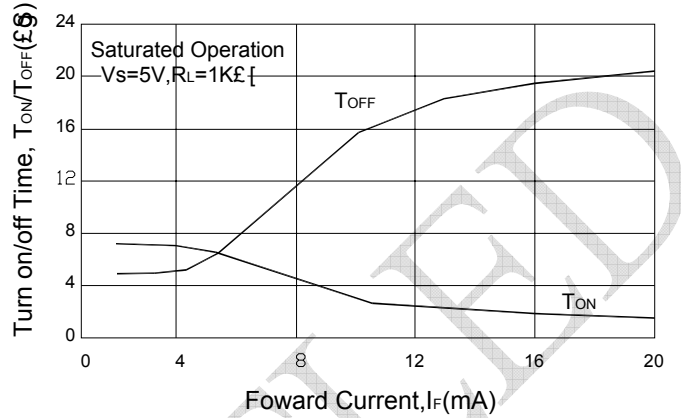

Figure9. I_C vs. V_{CE}

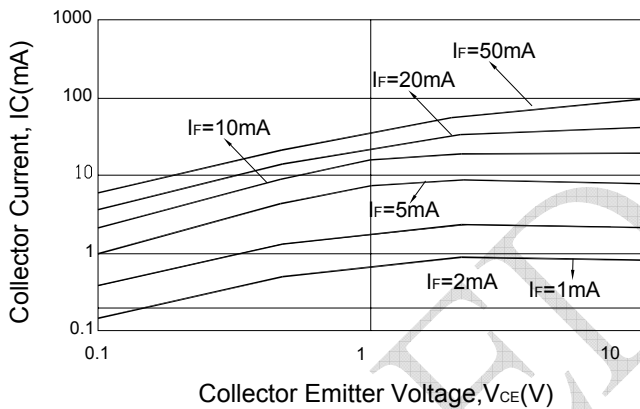

Figure10. Frequency Response

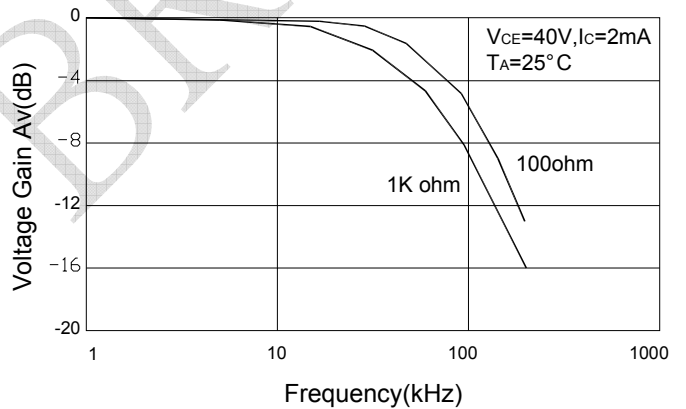
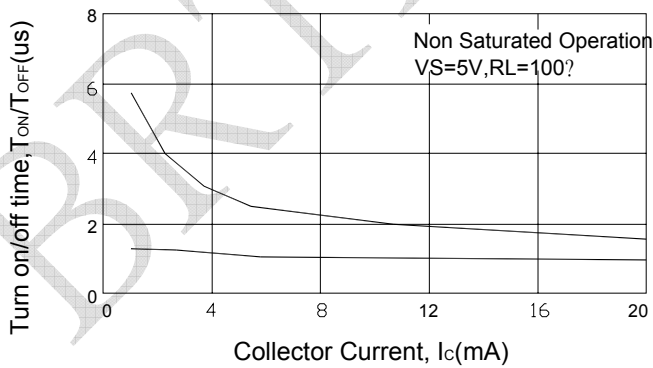
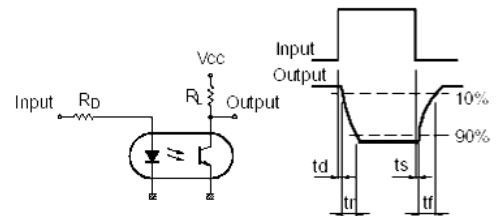

Figure11. T_{ON}/T_{OFF} vs. I_C



Test Circuit for Response Time



Test Circuit for Frequency Response

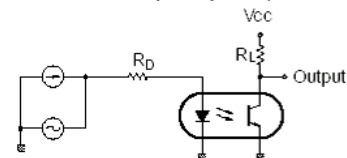



● Reliability Test

Classification	Test Item	Reference Standard	Test Conditions	Result
Endurance Test	Operation Life	MIL-STD-750:1026 MIL-STD-883:1005 JIS C 7021 :B-1	Connect with a power $I_f=50\text{mA}$ T_a =Under room temperature Test time=1,000hrs	0/20
	High Temperature High Humidity Reverse Bias (H3TRB)	JIS C 7021 :B-11	$T_a=+85^\circ\text{C}\pm 5^\circ\text{C}$, RH=85% PTR= V_{CE} absolute max rating*80% Test time=1000hrs	0/20
	High Temperature Reverse Bias (HTRB)	JIS C 7021 :B- 8	$T_a=+105^\circ\text{C}\pm 5^\circ\text{C}$ PTR= V_{CE} absolute max rating Test time=1000hrs	0/20
	High Temperature Storage	MIL-STD-883:1008 JIS C 7021 :B-10	High $T_a=+125^\circ\text{C}\pm 5^\circ\text{C}$ Test time=1,000hrs	0/20
	Low Temperature Storage	JIS-C-7021 :B-12	Low $T_a=-55^\circ\text{C}\pm 5^\circ\text{C}$ Test time=1,000hrs	0/20
	Autoclave	JESD 22-A102-B	P=15PSIG, $T_a=121^\circ\text{C}$ Humi. =100%RH, 48hrs	0/20
Environmental Test	Temperature Cycling	MIL-STD-202:107D MIL-STD-750:1051 MIL-STD-883:1010 JIS C 7021 :A-4	$125^\circ\text{C} \sim 25^\circ\text{C} \sim -55^\circ\text{C} \sim 25^\circ\text{C}$ 30min 5min 30min 5min Test Time=20cycle	0/20
	Thermal Shock	MIL-STD-202:107D MIL-STD-750:1051 MIL-STD-883:1011	$125^\circ\text{C} \sim -55^\circ\text{C}$ 20min 20min Test Time=20cycle	0/20
	Solder Resistance	MIL-STD-202:201A MIL-STD-750:2031 JIS C 7021 :A-1	Operation heating : 260°C , within 10 ± 1 seconds.	0/20
	Solder Ability	MIL-S-883:2003 JIS C 7021 :A-2	Operation heating : 235°C , within 5 ± 1 seconds.	0/20

● Judgment Criteria Of Failure For The Reliability

Symbol	Measuring conditions	Judgment criteria for failure
V_F (V)	$I_F=20\text{mA}$	Over $U_x1.0$
I_r (μA)	$V_r=6\text{V}$	Over $U_x1.0$
CTR(%)	$I_F=5\text{mA}$, $V_{CE}=5\text{V}$	Shift>1.2
$V_{CE(sat)}$	$I_F=20\text{mA}$, $I_C= 1\text{mA}$	Over $U_x1.0$
BV_{CEO}	$I_C=0.1\text{mA}$, $I_F=0$	Over $L_x1.0$
BV_{ECO}	$I_E=10\mu\text{A}$, $I_F=0$	Over $L_x1.0$

● Packaging Box Dimensions (Units: mm)

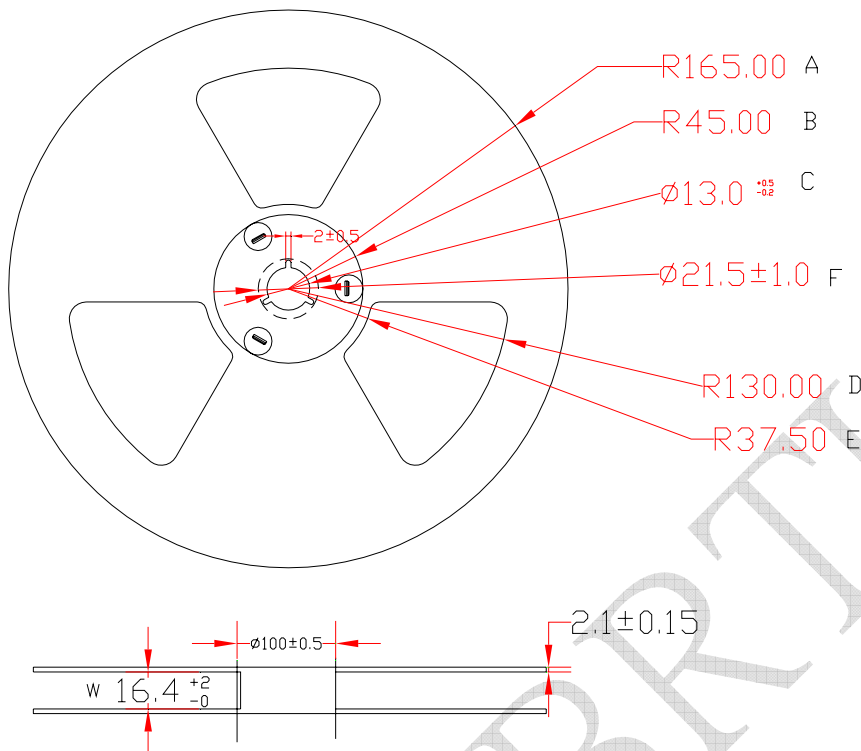

● Packaging Tube Dimensions

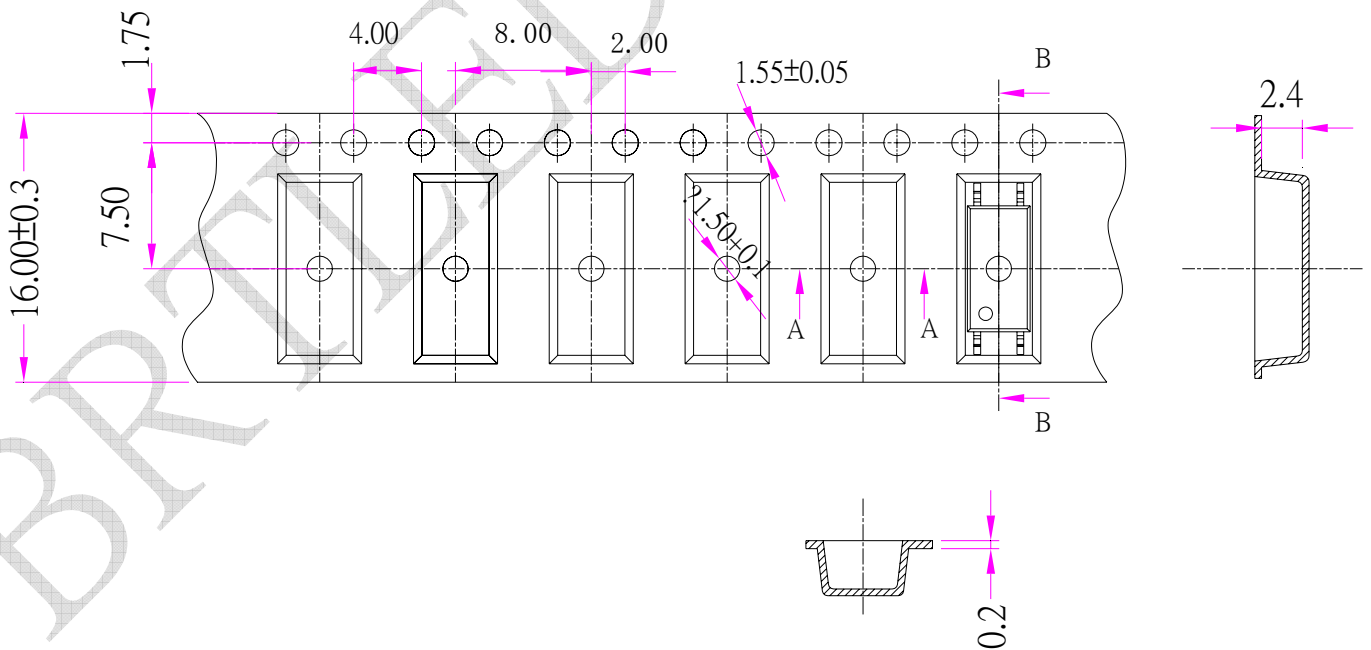



● Inner box

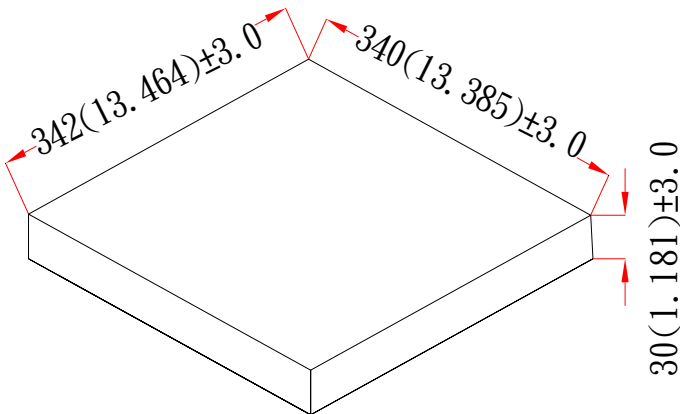

● Carton

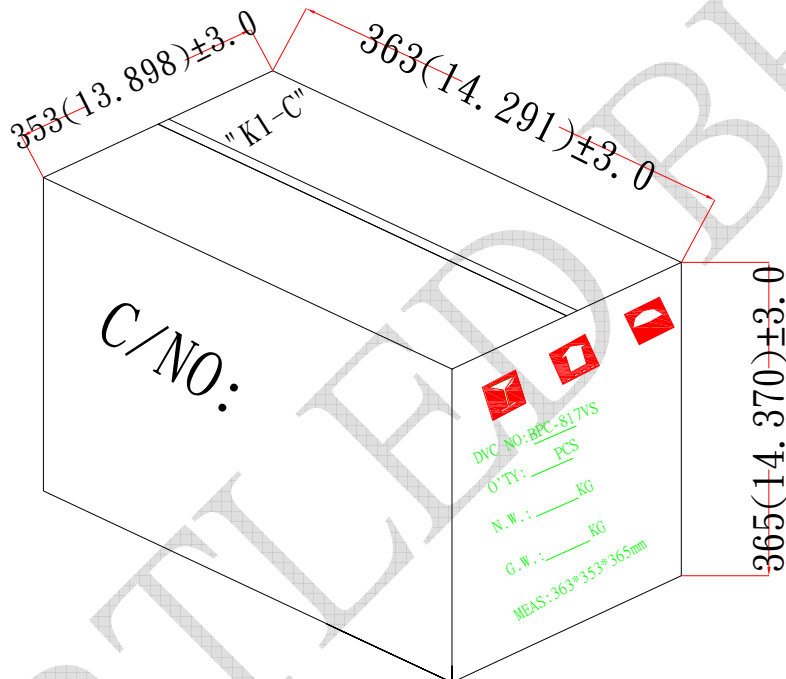

Notes:

1. 3000 PCS per reel, 10reels per Carton.
2. All dimensions are in millimeters (inches).
3. Tolerance is $\pm 0.10\text{mm}$ (0.004") unless otherwise specified.
4. Specifications are subject to change without notice.

单击下面可查看定价，库存，交付和生命周期等信息

[>>BRT\(佰鸿工业\)](#)