

KSE Series Low Profile Tact Switch

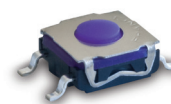

Features/Benefits

- Low profile
- Cost efficient
- J or G terminations
- Tape and reel
- IP67

Typical Applications

- Smart meters
- Home appliances
- Consumer electronics
- Industrial electronics
- Telecommunications

Specification

FUNCTION: momentary action
CONTACT ARRANGEMENT: 1 make contact = SPST, N.O.
TERMINALS: J bend & Gullwing type for SMT

Mechanical

Type	Operating Force FA (Newtons)		Operating Life Operations	Travel (mm)
	Min.	Max.		
KSEM31JLFS	1,6 ± 0,6		300,000	0,3 + 0,1/-0,2
KSEM31GLFS	1,6 ± 0,6		300,000	0,3 + 0,1/-0,2
KSEK43JLFS	2,25 ± 0,75		300,000	0,3 ± 0,2
KSEK43GLFS	2,25 ± 0,75		300,000	0,3 ± 0,2

NOTE: For cost effectiveness the tactile feeling is not specified and can change along production. If your application requires a defined tactile effect, please consider KSC series for your application.

Packaging

In reels of 2,000 pieces
Dimensions of reels according to EIA RS481 or IEC 2863.
External diameter 330 mm ± 2 mm.

Electrical

MAXIMUM POWER: 1 VA
MINIMUM/MAXIMUM VOLTAGE: 20 mV / 32 VDC
MINIMUM/MAXIMUM CURRENT: 1 mA / 50 mA
DIELECTRIC STRENGTH: (50 Hz, 1 min.): ≥ 250 V
CONTACT RESISTANCE: ≤ 100 mΩ
INSULATION RESISTANCE: (100 V): ≥ 10⁹ Ω
BOUNCE TIME: ≤ 1 ms

Environmental

OPERATING TEMPERATURE: -40°C to 85°C
STORAGE TEMPERATURE: -55°C to 85°C

Process

SOLDERING: Depending on the application, this component is suited to the following methods:
– Cleaning according to typical washing processes.
– Infrared Reflow Soldering in accordance with IEC 61760-1.

NOTE:

Specifications listed above are for switches with standard options. KSE series is not subject to adaptation and/or modification for specific use. If you require additional features, please refer to the KSC series. KSE is not recommended for applications requiring high level of performance such as aerospace, automotive and some industrial applications.

How To Order

Our easy build-a-switch concept allows you to mix and match options to create the switch you need. To order, select desired option from each category and place it in the appropriate box.

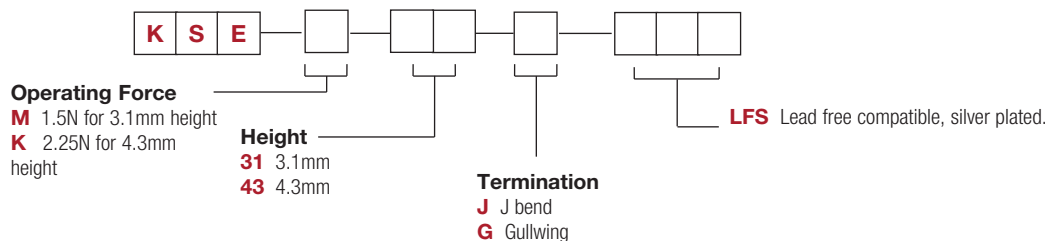

KSE Series Low Profile Tact Switch

HEIGHT

31 3.1 MM HEIGHT

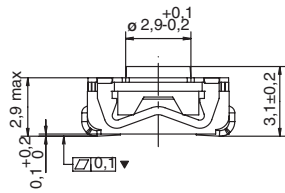

43 4.3 MM HEIGHT

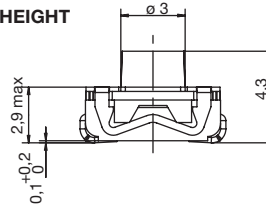

TERMINATION

G GULLWING

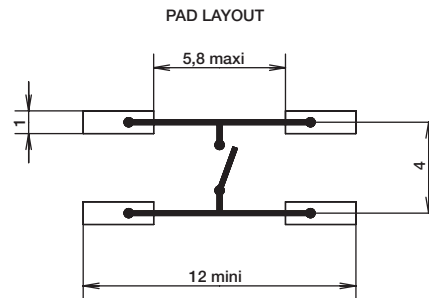
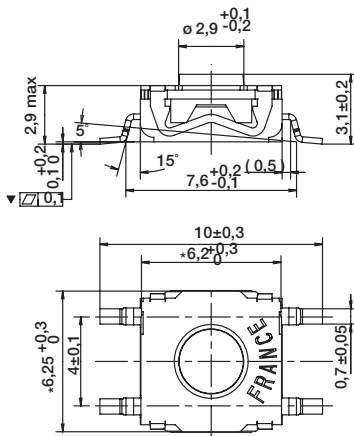

J J BEND

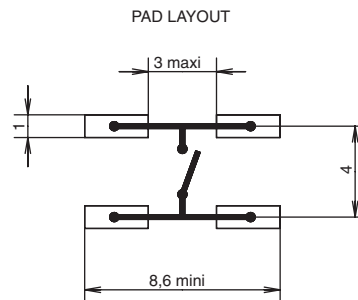
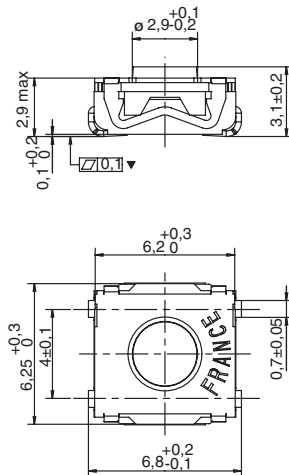

KSE Series Low Profile Tact Switch

TAPE & REEL

12 mm height

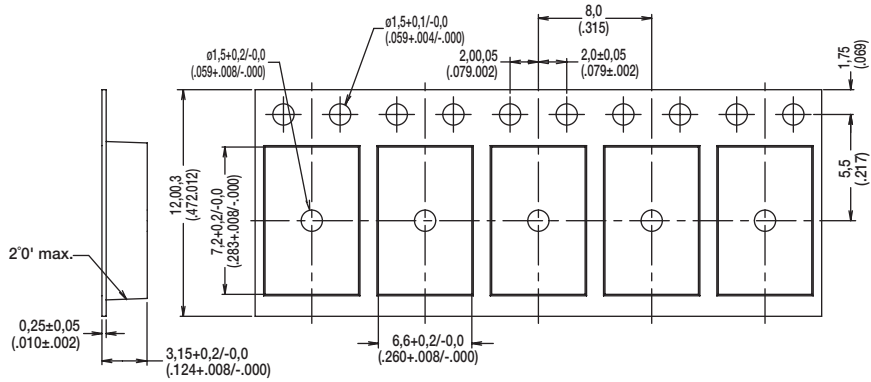

16 mm height

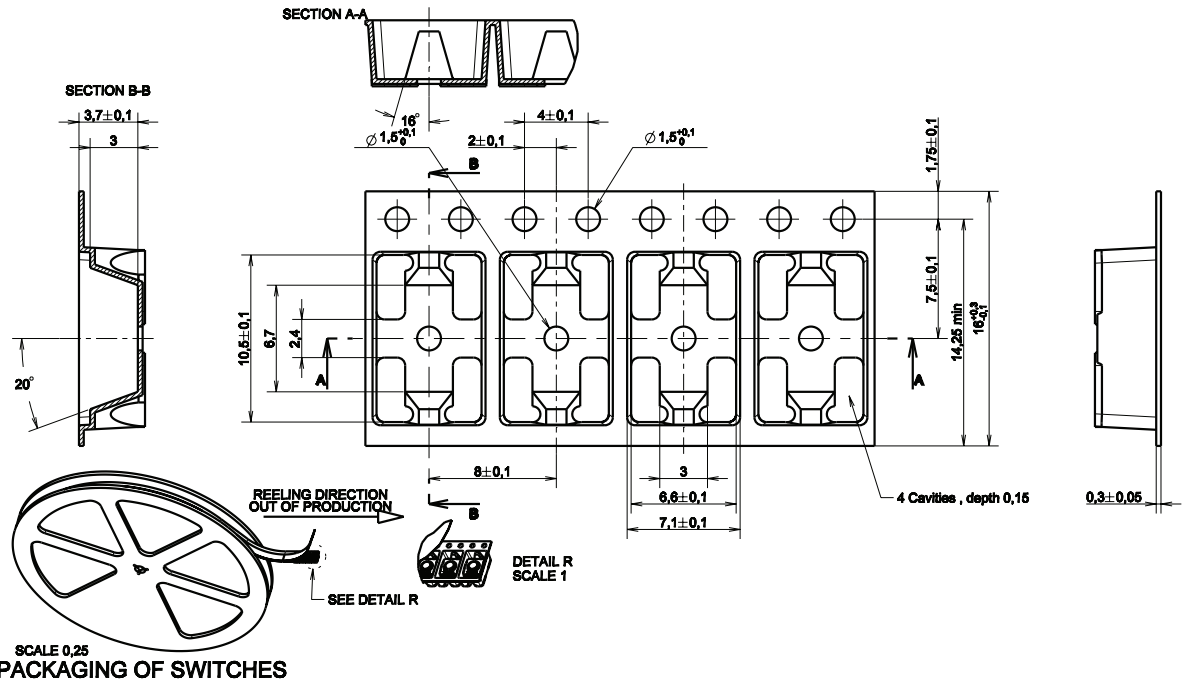

Tactile Switches

单击下面可查看定价，库存，交付和生命周期等信息

[>>C&K](#)