

FEATURES

- High power,Extremely Lower ESR,high energy density
- Long cycle life
- Maintenance-free
- No Explosion Safety
- RoHS Directive Compliant

APPLICATIONS

- Power Holdup Modules, Energy Harvesting, UPS/Industrial,Robotic Power,High Pulse Current Applications Emergency car energy storage.

OPERATING TEMPERATURE RANGE

- -40°C to +65°C @2.7V
- -40°C to +85°C @2.1V



GENERAL SPECIFICATIONS

Item	Performance
Operating temperature	-40°C to +65°C
Capacitance range	1.0F to 600F
Capacitance tolerance	-0%~+100%;-10%~+30%;-0%~+30%
Rated voltage	2.7 V
Surge voltage	2.85 V
Temperature characteristics	Capacitance change: Within ±30% of initial measured value at +25°C Internal resistance: Within ±200% of initial measured value at +25°C
High temperature load time	After 65°C 1500 hours (at 2.7V): Capacitance change: ±30% of initial rated value Internal resistance: Within 3 times of initial specified value
Projected cycle life (From rated voltage to 1/2 rated voltage at 25°C)	After 500,000 cycles: Capacitance change: Within ±30 % of initial rated value Internal resistance: Within 2 times of initial specified value
Humidity characteristic	Relative humidity: 90%~95% /Duration of testing:240 hrs /Temperature:40±2°C Capacitance change: Within ±30 % of initial rated value Internal resistance: Within 2 times of initial specified value
Vibration resistance	Amplitude:1.5mm /Frequency:10~55Hz /X,Y,Z(2hrs)/Duration of testing:6 hrs Capacitance change: Within ±30 % of initial rated value Internal resistance: Within 2 times of initial specified value
Shelf life	After 2 years at 25°C without load, the capacitor shall meet the specified endurance limits.

DIMENSIONS

RADIAL LEAD TYPE

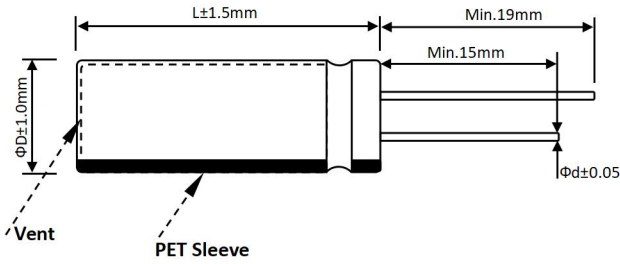

Size(mm)		
ΦD	P	Φd
8	3.5	0.6
10	5.0	0.6
12.5	5.0	0.6
16	7.5	0.8
18	8.0	0.8

RADIAL BENT LEAD TYPE

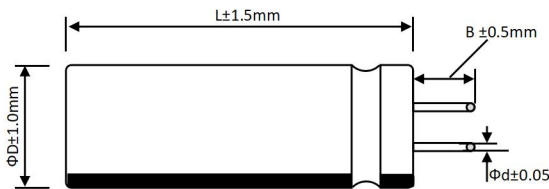

Style	B(mm)
A1	4.0
C1	2.0

SOLDER PIN TYPE 2-PIN 100~600F PART

Terminal Z2 type

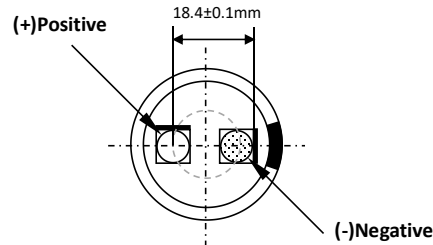
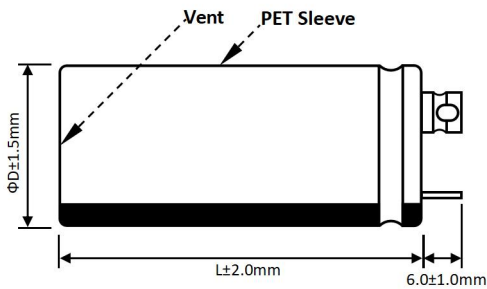

SOLDER PIN TYPE 4-PIN 300~600F PART

Terminal L4 type

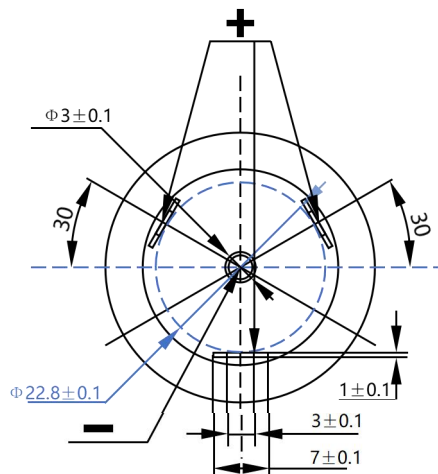
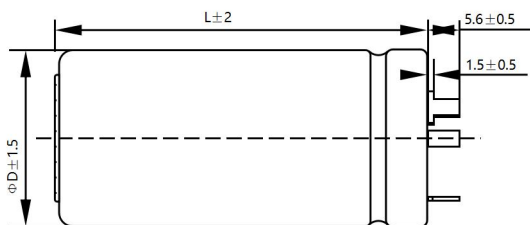

SOLDER PIN TYPE 4-PIN 400F PART

Terminal Z4 type

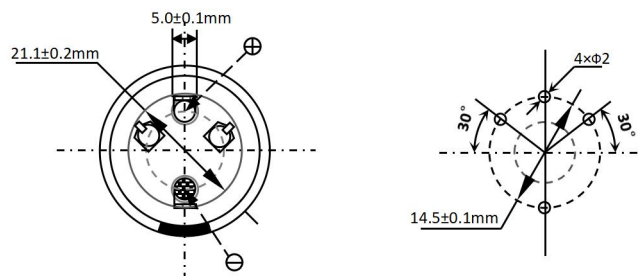
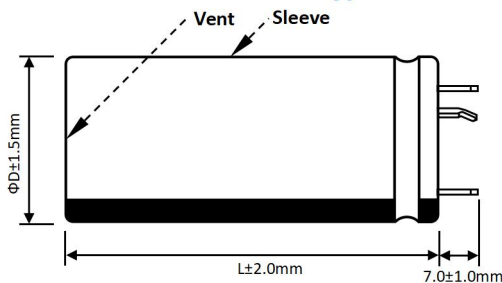

STANDARD PRODUCTS

Part Number	Working Voltage (V DC)	Rated Cap. (F)	Dimensions (mm) D*L	Max.ESR		Maximum Leakage (72hrs/mA)	Maximum Peak Current(A)	Maximum Endurance Current(A)	Power Density (W/Kg)	Maximum Energy (W.h)	Energy Density (Wh/kg)
				ESRAC (1kHz/mΩ)	ESRDC (mΩ)						
Radial Lead											
CHQ-2R7105R-TW	2.7	1	8*12	140	325	0.006	1.16	0.57	2833	0.0010	1.07
CHQ-2R7205R-TW	2.7	2	8*16	90	135	0.013	2.13	0.71	5945	0.0020	1.86
CHQ-2R7335R-TW	2.7	3.3	8*20	60	145	0.012	3.37	0.93	4161	0.0033	2.30
CHQ-2R7505R-TWX	2.7	5	8*25	55	83	0.020	4.78	1.11	6312	0.0051	3.01
CHQ-2R7505R-TW	2.7	5	10*20	27	65	0.015	5.19	1.19	6943	0.0051	2.41
CHQ-2R7705R-TW	2.7	7	10*25	30	45	0.030	7.19	1.70	7477	0.0071	2.73
CHQ-2R7106R-TWQ	2.7	10	10*30	20	55	0.030	8.71	2.02	5131	0.0101	3.27
CHQ-2R7106R-TWX	2.7	10	12.5*20	25	38	0.035	9.82	1.91	6762	0.0101	2.94
CHQ-2R7256R-TW	2.7	25	16*25	15	25	0.060	20.77	2.41	4793	0.0253	3.47
CHQ-2R7506R-TW	2.7	50	18*40	9	15	0.075	38.57	3.96	4486	0.0506	3.89
SOLDER PIN TYPE 2-PIN											
CHQ-2R7107R-TW	2.7	100	22*45	6.00	10.00	0.26	67.50	11.81	3803	0.1013	4.40
CHQ-2R7127R-TW	2.7	120	22*50	6.00	8.00	0.30	82.65	13.05	4050	0.1215	4.50
CHQ-2R7187R-TW	2.7	180	25*50	7.00	10.0	0.60	86.79	15.75	2955	0.1823	6.16
CHQ-2R7227R-TW	2.7	220	30*50	5.00	6.00	0.62	128.02	17.92	3038	0.2228	4.64
CHQ-2R7357R-TW	2.7	350	35*60	2.50	3.00	1.00	230.40	24.20	4550	0.3545	5.53
CHQ-2R7407R-TW	2.7	400	35*60	2.30	2.70	1.00	259.60	25.75	4620	0.4050	5.78
CHQ-2R7507R-TW	2.7	500	35*65	2.40	2.90	1.30	275.50	26.90	3770	0.5063	6.32
CHQ-2R7607R-TW	2.7	600	35*70	2.50	3.00	1.50	289.20	30.77	3470	0.6075	7.20
SOLDER PIN TYPE L4-PIN											
CHQ-2R7307R-TW	2.7	300	35*60	1.60	2.20	1.00	258.10	24.44	5321	0.3038	4.05
CHQ-2R7367R-TW	2.7	360	35*60	1.30	1.80	1.20	289.80	25.09	5927	0.3544	4.32
CHQ-2R7407R-TW	2.7	400	35*70	1.20	1.50	1.30	337.50	29.42	6480	0.4050	4.50
CHQ-2R7507R-TW	2.7	500	35*85	1.10	1.35	1.50	402.99	33.83	6230	0.5063	4.87
CHQ-2R7607R-TW	2.7	600	35*85	1.00	1.33	1.50	450.50	34.09	6205	0.6075	5.73
SOLDER PIN TYPE Z4-PIN											
CHQ-2R7407R-TWQ	2.7	400	35*66	2.50	2.90	1.00	270.0	22.20	4544	0.4050	5.26

*with appropriate voltage derating operating temperature can be extended to 85°C

QUALITY AND RELIABILITY

CAPACITANCE VS. TEMPERATURE

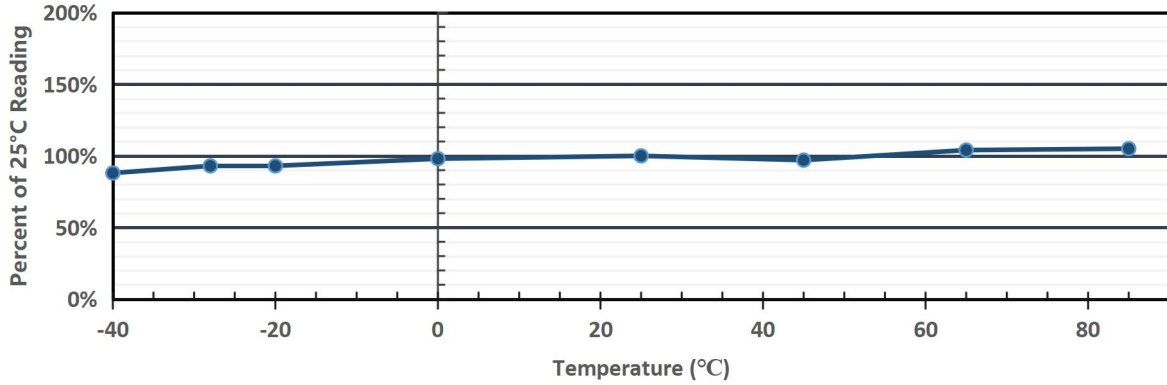

LEAKAGE CURRENT VS. TEMPERATURE

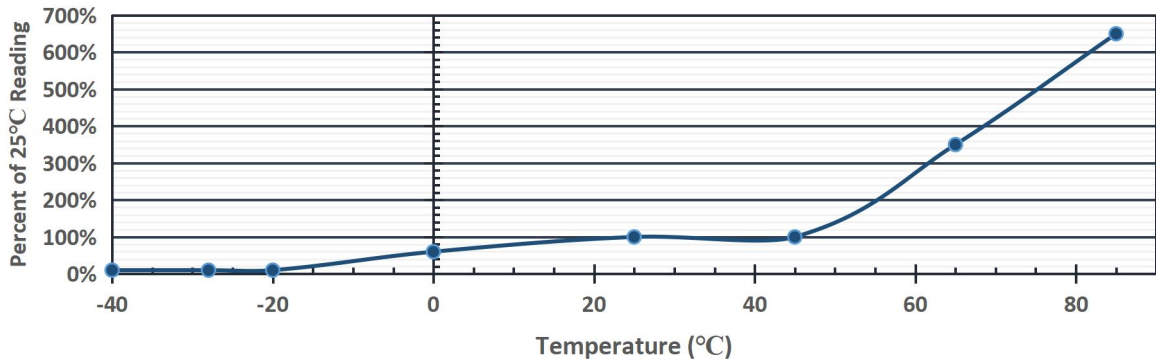

EQUIVALENT SERIES RESISTANCE VS. TEMPERATURE

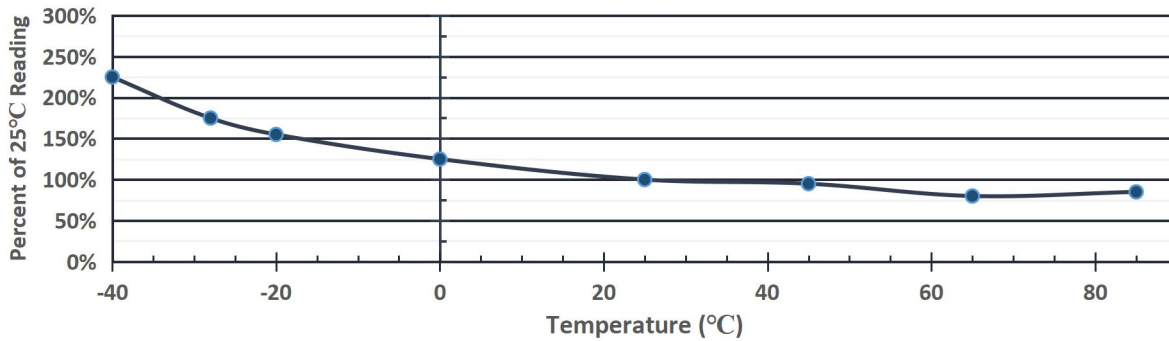

LIFE TIME AND TEMPERATURE PERFORMANCE

The life of a Super Capacitor is impacted by a combination of operating voltage and the operating temperature according to the following equation :

$$LS = L_R \times 2^X \times 2^Y$$

Which is $X = (T_m - T_a) / 10$ $Y = (V_r - V_a) / 0.2$

L_s = Expected life of the super capacitor in the application

L_R = Load life rating of the super capacitor

T_m = Max temperature rating of the super capacitor

T_a = Ambient temperature of the application

V_r = Rated voltage of the super capacitor

V_a = Maximum applied voltage on the super capacitor in the application

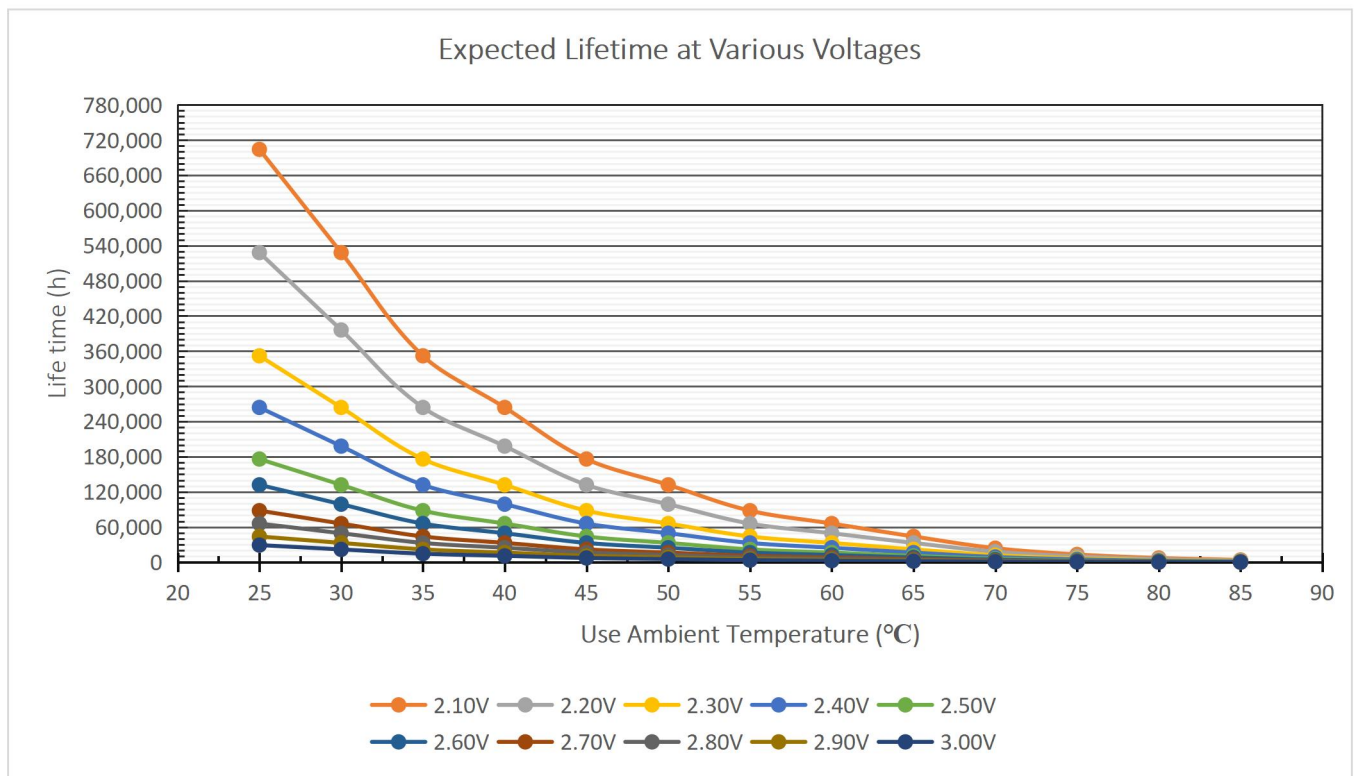

SAFETY RECOMMENDATIONS

WARNINGS

- To Avoid Short Circuit, after usage or test, SuperCapacitors voltage needs to discharge to $\leq 0.1V$
- Do not Apply Overvoltage, Reverse Charge, Burn or Heat Higher than 150°C, explosion-proof valve may break open
- Do not Press, Damage or disassemble the SuperCapacitors, housing could heat to high temperature causing Burns
- If you observe Overheating or Burning Smell from the capacitor disconnect Power immediately, and do not touch

REGULATORY

- MSDS
- RoHS Compliant
- Reach Compliant

TRANSPORTATION

Not subjected to US DOT or IATA regulations
UN3499, <10Wh, Non-Hazardous Goods
International shipping description –
“Electronic Products – Capacitor”

PRECAUTIONS FOR WELDING

When soldering supercapacitors to a PCB, the temperature & time that the body of the supercapacitor sees during soldering can have a negative effect on performance. We advise following these guidelines:

- Do not immerse the supercapacitors in solder. Only the leads should come in contact with the solder.
- Ensure that the body of the supercapacitor is never in contact with the molten solder, the PCB or other components during soldering.
- Excessive temperatures or excessive temperature cycling during soldering may cause the safety vent to burst or the case to shrink or crack, potentially damaging the PCB or other components, and significantly reduce the life of the capacitor.

HAND SOLDERING

Keep distance between the supercapacitor body and the tip of the soldering iron and the tip should never touch the body of the capacitor. Contact between supercapacitor body and soldering iron will cause extensive damage to the supercapacitor, and change its electrical properties. It is recommended that the soldering iron temperature should be less than 350°C, and contact time should be limited to less than 4 seconds. Too much exposure to terminal heat during soldering can cause heat to transfer to the body of the supercapacitor, potentially damaging the electrical properties of the supercapacitor.

WAVE SOLDERING

Only use wave soldering on Radial type supercapacitors. The PCB should be preheated only from the bottom and for less than 60 seconds, with temperature at, or below, 100°C on the top side of the board for PCBs equal to or greater than 0.8 mm thick.

Solder Temperature (°C)	Suggested Solder Time (s)	Maximum Solder Time (s)
220	7	9
240	7	9
250	5	7
260	3	5

REFLOW SOLDERING

Infrared or conveyor over reflow techniques can be used on these supercapacitors. Do not use a traditional reflow oven with-out clear rated reflow temperature for supercapacitors.

单击下面可查看定价，库存，交付和生命周期等信息

[>>CDA\(智烽维\)](#)