

**Common Mode Choke APPM Series**

**Automotive  
AEC-Q200**

RoHS Compliant  
Halogen Free  
REACH Compliant

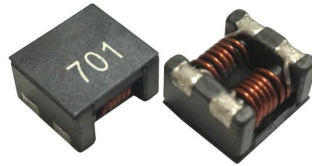

Noise  
Suppression

Wire  
Wound

Ferrite

Automotive  
Power line

**Part Numbering**

A	PPM	00	070638	800	X	Y0
Grade	Series Name	Control Code	Dimensions Code (mm)	Impedance (Ω) Min	Tolerance	Internal Code
			050524 4.7x4.5x2.4	800 80Ω		YE
			070638 7x6x3.8	101 100Ω		Y0
			090748 9x7x4.8	701 500Ω		
			121165 12x10.8x6.5			
			151365 15x13x6.5			
			485023 4.8x5.0x2.3			

Please be sure to request approval specifications that provide further details of the products. Kindly note that the content of these specifications are subject to change or may be discontinued without prior notice. This product may not be designed/used in medical or high risk applications without Chilisin approval. Please contact our sales department before ordering.

**APPM00050524 - YE Type**

**■ Dimensions**

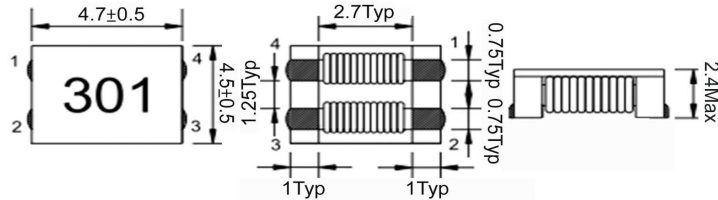

unit:mm

**■ Recommended Land Pattern**

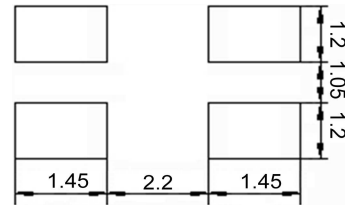

unit:mm

**■ Electrical Characteristics**

Part No.	Impedance(Ω)		Test Freq.	RDC (mΩ)Max.	Rated Current (A) Max	Insulation Resistance (MΩ) Min	Rated Voltage (V) Max	Marking
	Min.	Typ.						
APPM00050524301XYE	100	300	100 MHz,0.5 V	45	3	10	50	301
APPM00050524401XYE	200	400	100 MHz,0.5 V	50	2.5	10	50	401
APPM00050524701XYE	500	700	100 MHz,0.5 V	59	2.2	10	50	701
APPM00050524102XYE	800	1000	100 MHz,0.5 V	68	2.1	10	50	102
APPM00050524122XYE	1000	1200	100 MHz,0.5 V	74	2	10	50	122
APPM00050524142XYE	1200	1400	100 MHz,0.5 V	81	1.9	10	50	142

- Operating temperature range - 40°C ~ 125°C
- Rated Current: Based on temperature rise ( $\Delta T: 40^\circ\text{C}$  Typ.)
- Measure Equipment:  
Z : HP 4291B IMPEDANCE ANALYZER (or equivalent)  
RDC : CHROMA MODEL 16502 MILLIOHMMETER (or equivalent)  
Rated Current : WK3255BQ+ WK3265B (or equivalent)  
I.R : CHROMA MODEL 19073 AC/DC/IR HIPOT TESTER (or equivalent)

**APPM00070638 - Y0 Type**

**Dimensions**

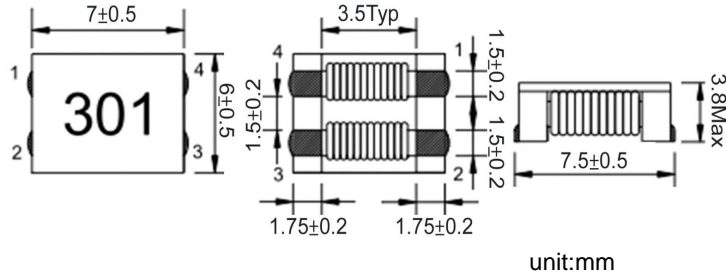

unit:mm

**Recommended Land Pattern**

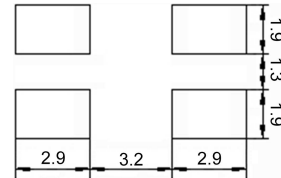

unit:mm

**Electrical Characteristics**

Part No.	Impedance(Ω)		Test Freq.	RDC (mΩ)Max.	Rated Current (A) Max	Insulation Resistance (MΩ) Min	Rated Voltage (V) Max	Marking
	Min.	Typ.						
APPM00070638101XY0	100	140	100 MHz,0.5 V	10	9	10	125	101
APPM00070638301XY0	225	300	100 MHz,0.5 V	10	5	10	125	301
APPM00070638501XY0	275	350	100 MHz,0.5 V	10	5	10	125	501
APPM00070638701XY0	500	700	100 MHz,0.5 V	15	4	10	125	701
APPM00070638102XY0	800	1020	100 MHz,0.5 V	17	3	10	125	102
APPM00070638132XY0	910	1300	100 MHz,0.5 V	21	2.5	10	125	132
APPM00070638272XY0	2000	2700	100 MHz,0.5 V	63	1	10	125	272
APPM00070638302XY0	2500	3000	100 MHz,0.5 V	75	0.9	10	125	302

1. Operating temperature range - 40°C ~ 125°C
2. Rated Current: Based on temperature rise ( $\Delta T: 40^\circ\text{C}$  Typ.)
3. Measure Equipment:  
 Z : HP 4291B IMPEDANCE ANALYZER (or equivalent)  
 RDC : CHROMA MODEL 16502 MILLIOHMMETER (or equivalent)  
 Rated Current : WK3255BQ+ WK3265B (or equivalent)  
 I.R : CHROMA MODEL 19073 AC/DC/IR HIPOT TESTER (or equivalent)

**APPM00090748 - Y0 Type**

**■ Dimensions**

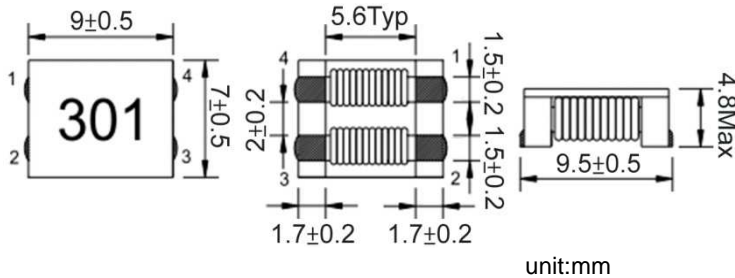

unit:mm

**■ Recommended Land Pattern**

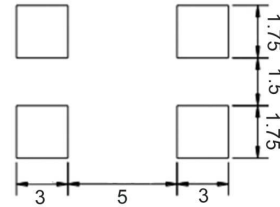

unit:mm

**■ Electrical Characteristics**

Part No.	Impedance(Ω)		Test Freq.	RDC (mΩ)Max.	Rated Current (A) Max	Insulation Resistance (MΩ) Min	Rated Voltage (V) Max	Marking
	Min.	Typ.						
APPM00090748301XY0	225	300	100 MHz,0.5 V	6	6	10	80	301
APPM00090748501XY0	450	600	100 MHz,0.5 V	8	5.5	10	80	501
APPM00090748701XY0	500	700	100 MHz,0.5 V	10	5	10	80	701
APPM00090748102XY0	750	1000	100 MHz,0.5 V	13	4	10	80	102
APPM00090748152XY0	1100	1500	100 MHz,0.5 V	18	3.5	10	80	152
APPM00090748222XY0	1700	2200	100 MHz,0.5 V	60	2.5	10	80	222
APPM00090748272XY0	2000	2700	100 MHz,0.5 V	86	2	10	80	272

1. Operating temperature range - 40°C ~ 125°C
2. Rated Current: Based on temperature rise ( $\Delta T: 40^\circ\text{C}$  Typ.)
3. Measure Equipment:  
 Z : HP 4291B IMPEDANCE ANALYZER (or equivalent)  
 RDC : CHROMA MODEL 16502 MILLIOHMMETER (or equivalent)  
 Rated Current : WK3255BQ+ WK3265B (or equivalent)  
 I.R : CHROMA MODEL 19073 AC/DC/IR HIPOT TESTER (or equivalent)

**APPM00121165 - Y0 Type**

**Dimensions**

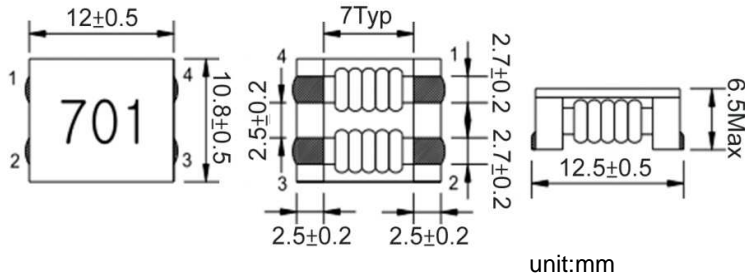

unit:mm

**Recommended Land Pattern**

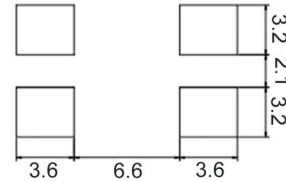

unit:mm

**Electrical Characteristics**

Part No.	Impedance(Ω)		Test Freq.	RDC (mΩ)Max.	Rated Current (A) Max	Insulation Resistance (MΩ) Min	Rated Voltage (V) Max	Marking
	Min.	Typ.						
APPM00121165800XY0	80	230	100 MHz,0.5 V	2.2Typ	10	10	80	800
APPM00121165701XY0	500	700	100 MHz,0.5 V	6	8	10	80	701
APPM00121165801XY0	600	800	100 MHz,0.5 V	8	8	10	80	801
APPM00121165102XY0	750	1000	100 MHz,0.5 V	14	6	10	80	102
APPM00121165222XY0	2200	2500	10 MHz,0.5 V	35	1.8	10	80	222
APPM00121165272XY0	2300	2700	10 MHz,0.5 V	50	1.5	10	80	272

- Operating temperature range - 40°C ~ 125°C
- Rated Current: Based on temperature rise ( $\Delta T: 40^\circ\text{C}$  Typ.)
- Measure Equipment:  
Z : HP 4291B IMPEDANCE ANALYZER (or equivalent)  
RDC : CHROMA MODEL 16502 MILLIOHMMETER (or equivalent)  
Rated Current : WK3255BQ+ WK3265B (or equivalent)  
I.R : CHROMA MODEL 19073 AC/DC/IR HIPOT TESTER (or equivalent)

**APPM00151365 - Y0 Type**

**Dimensions**

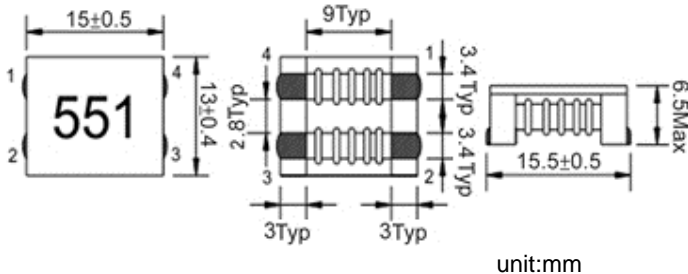

unit:mm

**Recommended Land Pattern**

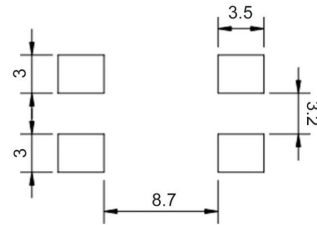

unit:mm

**Electrical Characteristics**

Part No.	Impedance(Ω)		Test Freq.	RDC (mΩ)Max.	Rated Current (A) Max	Insulation Resistance (MΩ) Min	Rated Voltage (V) Max	Marking
	Min.	Typ.						
APPM00151365301XY0	250	300	100 MHz,0.5 V	4.7	13	10	125	301
APPM00151365551XY0	450	550	100 MHz,0.5 V	3.8±20%	10	10	125	551
APPM00151365701XY0	500	700	100 MHz,0.5 V	7	10	10	125	701
APPM00151365102XY0	600	1000	100 MHz,0.5 V	9	8.5	10	125	102
APPM00151365152XY0	1100	1500	50 MHz,0.5 V	9	8.5	10	125	152
APPM00151365232XY0	1800	2300	50 MHz,0.5 V	11	7	10	125	322
APPM00151365322XY0	2700	3200	40 MHz,0.5 V	11.5	6	10	125	322
APPM00151365432XY0	3700	4300	30 MHz,0.5 V	21	5	10	125	432

1. Operating temperature range - 40°C ~ 125°C
2. Rated Current: Based on temperature rise ( $\Delta T$ :40°C Typ.)
3. Measure Equipment:  
 Z : HP 4291B IMPEDANCE ANALYZER (or equivalent)  
 RDC : CHROMA MODEL 16502 MILLIOHMMETER (or equivalent)  
 Rated Current : WK3255BQ+ WK3265B (or equivalent)  
 I.R : CHROMA MODEL 19073 AC/DC/IR HIPOT TESTER (or equivalent)

**APPM00485023 - Y0 Type**

**Dimensions**

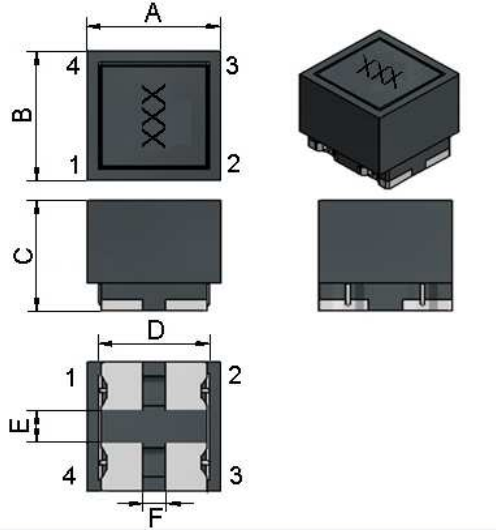

unit:mm

**Recommended Land Pattern**

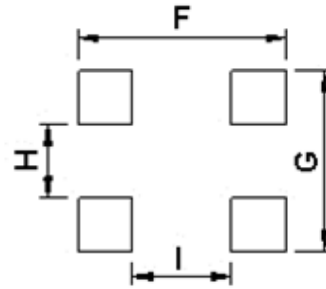

unit:mm

**Electrical Characteristics**

Part No.	Impedance( $\Omega$ )		RDC(m $\Omega$ ) $\pm 40\%$	I <sub>rms</sub> (A)Max.	Rated Voltage (V)Max.	Withstanding voltage (V)Max.	Insulation Resistance (M $\Omega$ )Min.	Marking
	Typ. @ 10MHz	Typ. @ 100MHz						
APPM00485023251XY0	20	250	14	5	50	125	10	251
APPM00485023501XY0	30	500	19	4	50	125	10	501
APPM00485023102XY0	60	1000	24	3	50	125	10	102
APPM00485023142XY0	100	1400	40	2	50	125	10	142
APPM00485023152XY0	100	1500	40	2	50	125	10	152

- Operating temperature range - 40°C ~ 125°C
- Rated Current: Based on temperature rise ( $\Delta T: 40^\circ\text{C}$  Typ.)
- Measure Equipment:  
 Z : HP 4291B IMPEDANCE ANALYZER (or equivalent)  
 RDC : CHROMA MODEL 16502 MILLIOHMMETER (or equivalent)  
 Rated Current : WK3255BQ+ WK3265B (or equivalent)  
 I.R : CHROMA MODEL 19073 AC/DC/IR HIPOT TESTER (or equivalent)

**■ Packaging**

Tape Dimensions

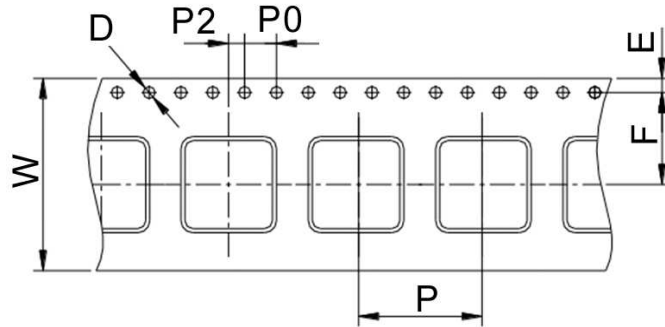

Reel Dimensions

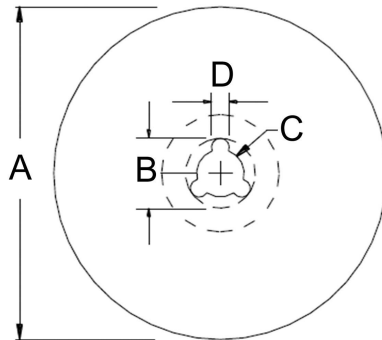

Dimensions in mm

TYPE	Tape Dimensions							Reel Dimensions				Quantity PCS / REEL
	W	D	E	F	P	P0	P2	A	B	C	D	
APPM00050524	12	1.5	1.75	5.5	8	4	2	178	20	13	2	1000
APPM00070638	16	1.5	1.75	7.5	12	4	2	330	20	13	2	1500
APPM00090748	24	1.5	1.75	11.5	16	4	2.02	330	20	13	2	700
APPM00121165	24	1.5	1.75	11.5	16	4	2	330	20	13	2	500
APPM00151365	24	1.5	1.75	11.5	20	4	2	330	20	13	2	450
APPM00485023	12	1.5	1.75	5.5	8	4	2	330	21.5	13	2	2500

Please be sure to request approval specifications that provide further details of the products. Kindly note that the content of these specifications are subject to change or may be discontinued without prior notice. This product may not be designed/used in medical or high risk applications without Chilisin approval. Please contact our sales department before ordering.



单击下面可查看定价，库存，交付和生命周期等信息

[>>CHILISIN\(奇力新\)](#)