

Power Inductor APCA Series

**Automotive
AEC-Q200**

RoHS Compliant
Halogen Free
REACH Compliant



Power
Circuit

Shield

Wire
Wound

Ferrite

Part Numbering

A	PCA	00	060645	1R0	T	00
Grade	Series Name	Control Code	Dimensions Code (mm)	Inductance (uH)	Tolerance	Internal Code
			060645 6.0x6.3x4.5	1R0 1.0	M ±20%	
			070745 7.0x7.4x4.5	100 10	T ±30%	
			101065 10.3x10.0x6.5	101 100		
			121280 12.5x12.3x8.0			

Please be sure to request approval specifications that provide further details of the products. Kindly note that the content of these specifications are subject to change or may be discontinued without prior notice. This product may not be designed/used in medical or high risk applications without Chilisin approval. Please contact our sales department before ordering.

APCA00060645 Type

■ Dimensions

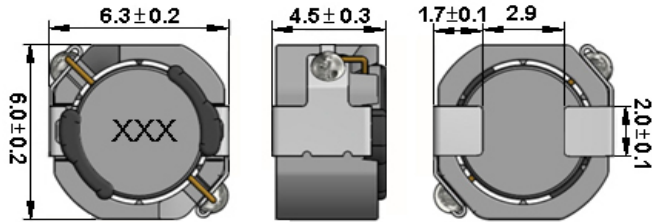

unit:mm

■ Recommended Land Pattern

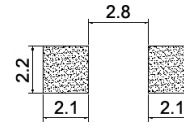

unit:mm

■ Electrical Characteristics

Part No.	Inductance (uH)	Test Freq.	RDC (Ω)Max.	Isat (A)Max.	Irms (A)	Tolerance (±%)	Marking
APCA000606451R0□00	1.0	100 kHz,1 V	0.0143	6.0	4.8	30	1R0
APCA000606451R5□00	1.5	100 kHz,1 V	0.0169	5.2	4.5	30	1R5
APCA000606452R2□00	2.2	100 kHz,1 V	0.0195	3.6	4.1	30	2R2
APCA000606453R3□00	3.3	100 kHz,1 V	0.0247	3.2	3.7	30	3R3
APCA000606454R7□00	4.7	100 kHz,1 V	0.0299	2.5	3.3	30	4R7
APCA000606456R8□00	6.8	100 kHz,1 V	0.0351	2.0	3.1	30	6R8
APCA00060645100□00	10	100 kHz,1 V	0.042	1.7	2.6	20	100
APCA00060645150□00	15	100 kHz,1 V	0.072	1.4	2.0	20	150
APCA00060645220□00	22	100 kHz,1 V	0.09	1.1	1.8	20	220
APCA00060645330□00	33	100 kHz,1 V	0.12	0.9	1.6	20	330
APCA00060645470□00	47	100 kHz,1 V	0.156	0.78	1.4	20	470
APCA00060645680□00	68	100 kHz,1 V	0.24	0.65	1.1	20	680
APCA00060645101□00	100	100 kHz,1 V	0.384	0.55	0.86	20	101
APCA00060645151□00	150	100 kHz,1 V	0.576	0.46	0.72	20	151
APCA00060645221□00	220	100 kHz,1 V	0.864	0.36	0.57	20	221
APCA00060645331□00	330	100 kHz,1 V	1.104	0.28	0.49	20	331
APCA00060645471□00	470	100 kHz,1 V	1.56	0.25	0.41	20	471

Note: When ordering, please specify tolerance code. Tolerance: M=±20% / T=±30%

1. Operating temperature range -40°C ~ 150°C (Including self - temperature rise)
2. Isat for Inductance drop 30% from its value without current
3. The actual use current is suggested not to be out of Isat*80%
4. I rms for a 40°C temprature rise from 25°C ambient.
5. Measure Equipment:
L: HP4284+42841A
RDC: Chroma 16502
Isat: HP4284+42841A

APCA00060645 Type

Characteristics Graph

Inductance vs. Frequency Characteristics

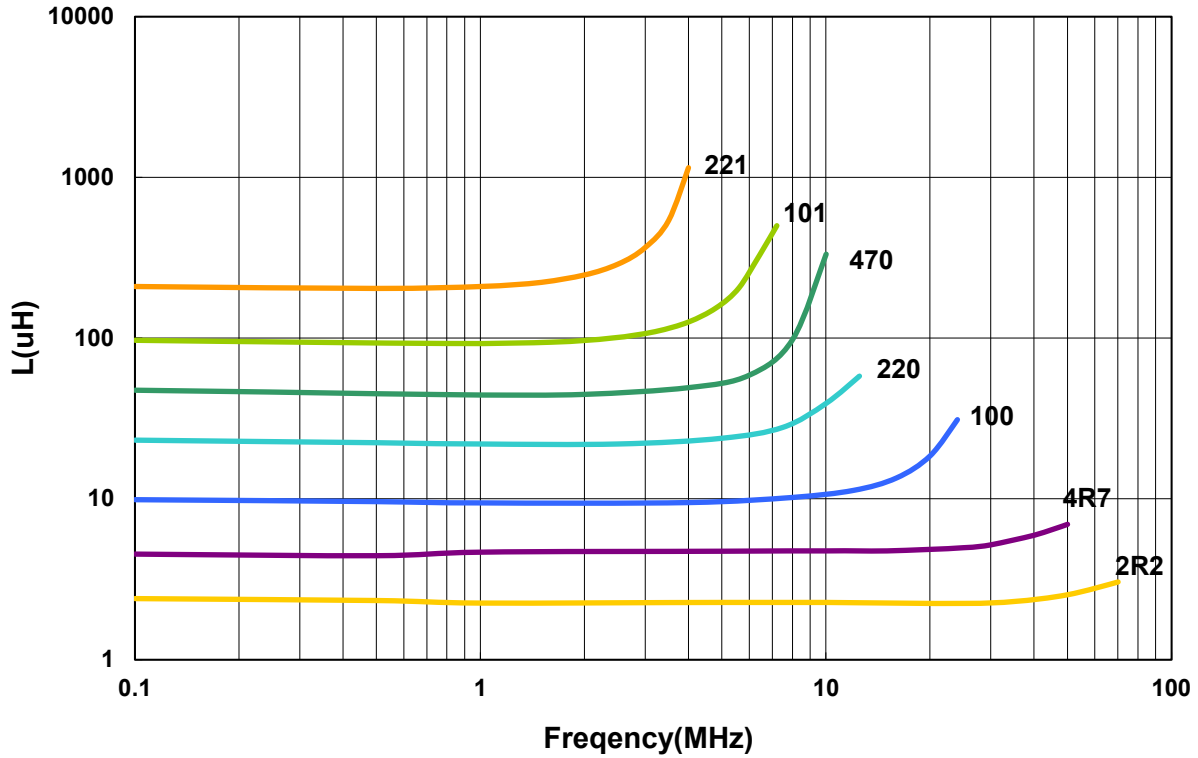

Inductance vs. DC Current

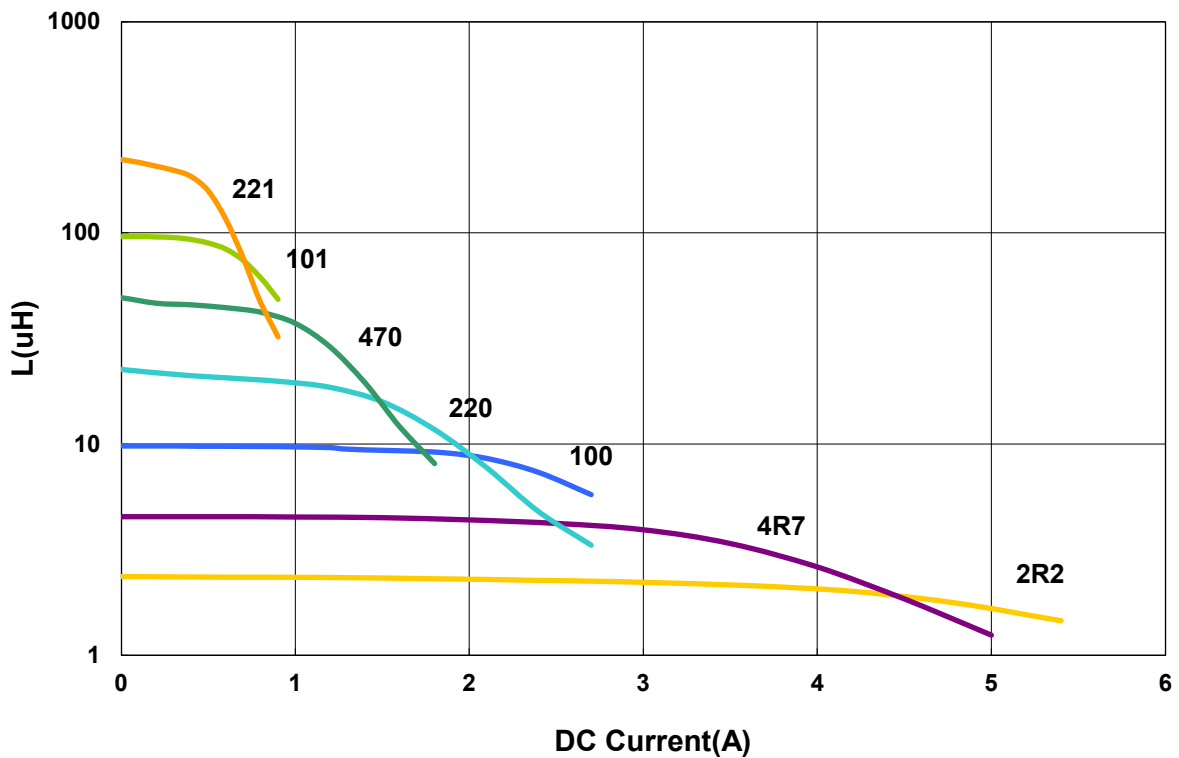

Please be sure to request approval specifications that provide further details of the products. Kindly note that the content of these specifications are subject to change or may be discontinued without prior notice. This product may not be designed/used in medical or high risk applications without Chilisin approval. Please contact our sales department before ordering.

APCA00070745 Type

■ Dimensions

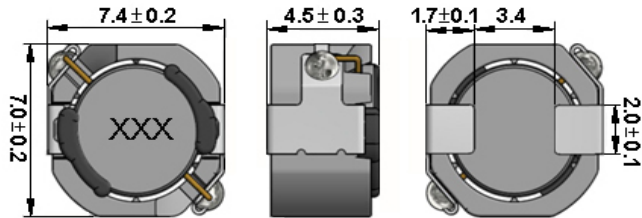

unit:mm

■ Recommended Land Pattern

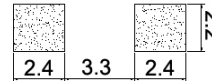

unit:mm

■ Electrical Characteristics

Part No.	Inductance (uH)	Test Freq.	RDC (Ω)Max.	Isat (A)Max.	Irms (A)	Tolerance (±%)	Marking
APCA000707451R0□00	1.0	100 kHz,1 V	0.0117	7.6	6.5	30	1R0
APCA000707451R5□00	1.5	100 kHz,1 V	0.013	6.2	5.4	30	1R5
APCA000707452R2□00	2.2	100 kHz,1 V	0.0169	6.0	5.1	30	2R2
APCA000707453R3□00	3.3	100 kHz,1 V	0.0208	4.6	4.8	30	3R3
APCA000707454R7□00	4.7	100 kHz,1 V	0.0234	4.0	4.1	30	4R7
APCA000707456R8□00	6.8	100 kHz,1 V	0.0264	3.0	3.9	30	6R8
APCA00070745100□00	10	100 kHz,1 V	0.0396	2.6	3.1	20	100
APCA00070745150□00	15	100 kHz,1 V	0.066	2.0	2.6	20	150
APCA00070745220□00	22	100 kHz,1 V	0.0828	1.6	2.2	20	220
APCA00070745330□00	33	100 kHz,1 V	0.116	1.3	1.8	20	330
APCA00070745470□00	47	100 kHz,1 V	0.156	1.1	1.7	20	470
APCA00070745680□00	68	100 kHz,1 V	0.204	0.95	1.5	20	680
APCA00070745101□00	100	100 kHz,1 V	0.312	0.8	1.05	20	101
APCA00070745151□00	150	100 kHz,1 V	0.516	0.65	0.95	20	151
APCA00070745221□00	220	100 kHz,1 V	0.66	0.54	0.75	20	221
APCA00070745331□00	330	100 kHz,1 V	0.96	0.45	0.58	20	331
APCA00070745471□00	470	100 kHz,1 V	1.44	0.37	0.46	20	471

Note: When ordering, please specify tolerance code. Tolerance: M=±20% / T=±30%

1. Operating temperature range -40°C ~ 150°C (Including self - temperature rise)
2. Isat for Inductance drop 30% from its value without current
3. The actual use current is suggested not to be out of Isat*80%
4. I rms for a 40°C temprature rise from 25°C ambient.
5. Measure Equipment:
L: HP4284+42841A
RDC: Chroma 16502
Isat: HP4284+42841A

APCA00070745 Type

Characteristics Graph

Inductance vs. Frequency Characteristics

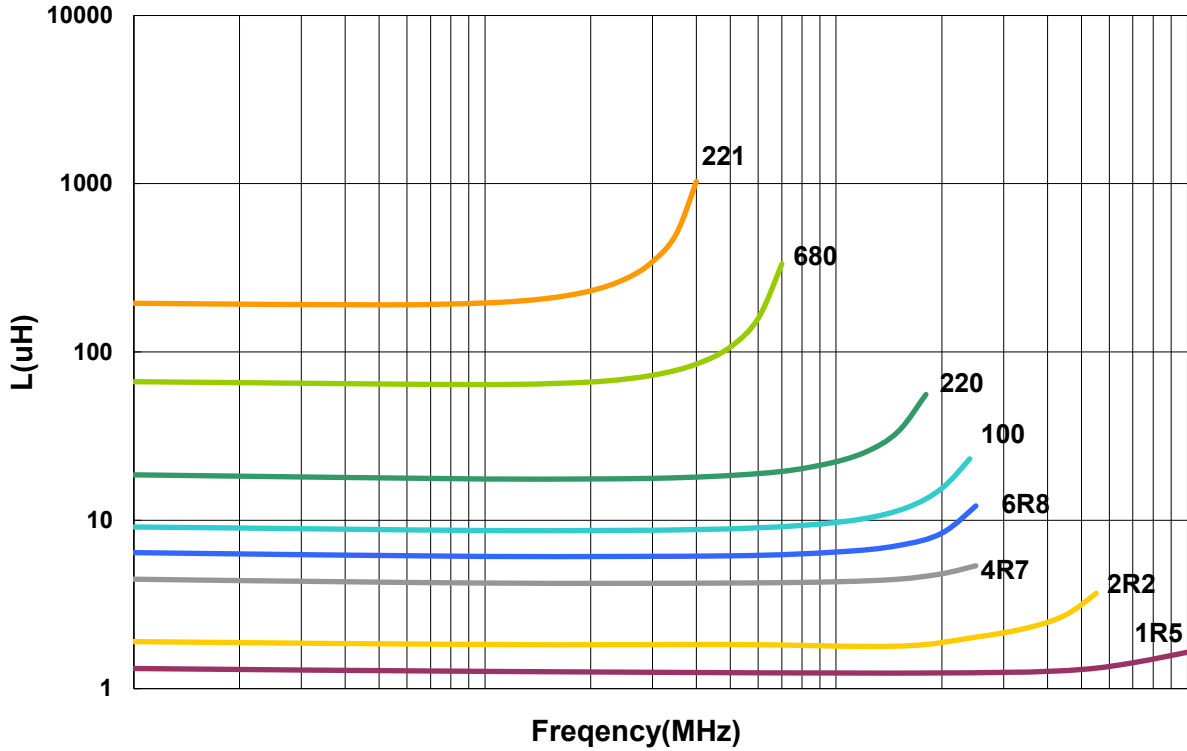

Inductance vs. DC Current

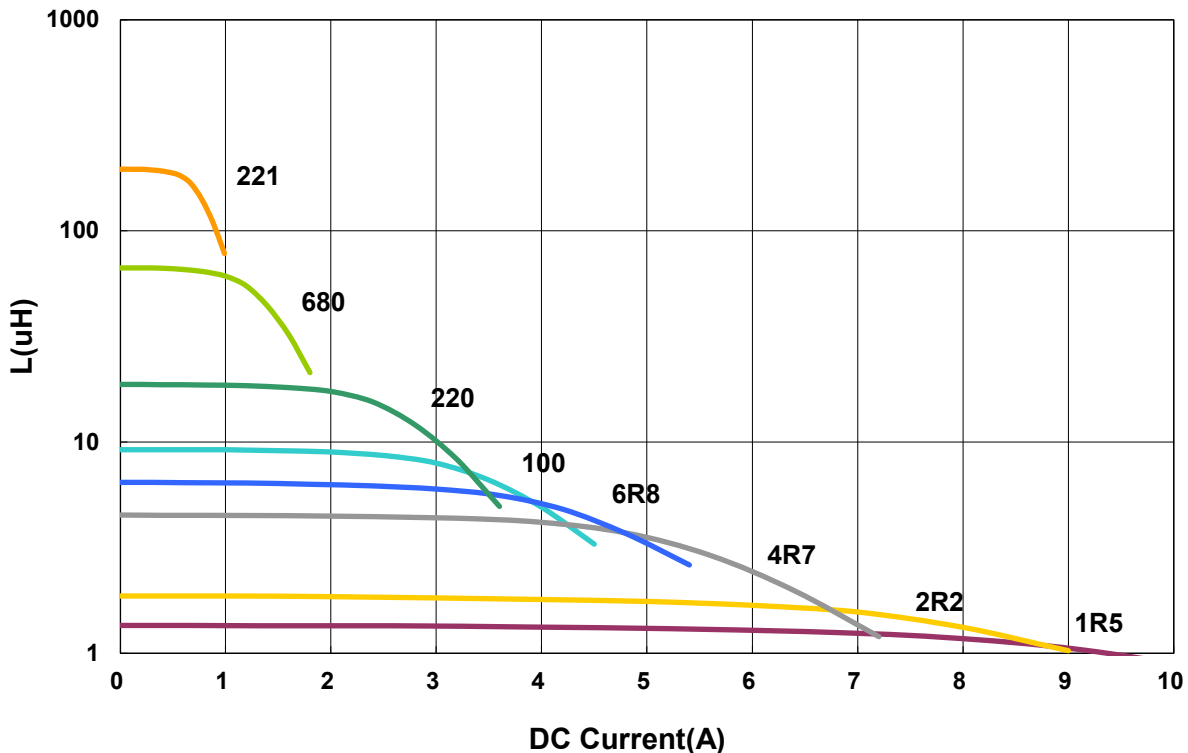

Please be sure to request approval specifications that provide further details of the products. Kindly note that the content of these specifications are subject to change or may be discontinued without prior notice. This product may not be designed/used in medical or high risk applications without Chilisin approval. Please contact our sales department before ordering.

APCA00101065 Type

■ Dimensions

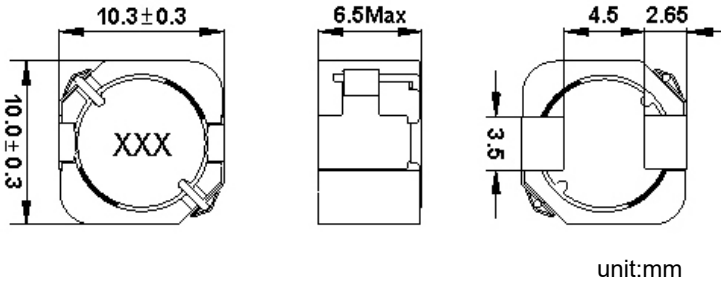

■ Recommended Land Pattern

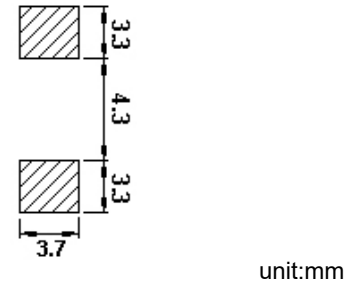

■ Electrical Characteristics

Part No.	Inductance (uH)	Test Freq.	RDC (mΩ)	Isat (A)Typ	Irms (A)Typ	Tolerance (±%)	Marking
APCA001010652R2□80	2.2	100kHz,0.25V	7.1±30%	11	8.5	30	2R2
APCA001010653R3□80	3.3	100kHz,0.25V	8.5±30%	8.4	8.1	30	3R3
APCA001010654R7□80	4.7	100kHz,0.25V	11±30%	8	7	30	4R7
APCA001010656R8□80	6.8	100kHz,0.25V	13±30%	6.5	6.6	30	6R8
APCA00101065100□80	10	100kHz,0.25V	17±20%	5	5.8	20,30	100
APCA00101065150□80	15	100kHz,0.25V	30±20%	4.4	4.1	20,30	150
APCA00101065220□80	22	100kHz,0.25V	43±20%	3.6	3.3	20,30	220
APCA00101065330□80	33	100kHz,0.25V	61±20%	3.1	2.9	20,30	330
APCA00101065470□80	47	100kHz,0.25V	74±20%	2.35	2.6	20,30	470
APCA00101065680□80	68	100kHz,0.25V	91±20%	2.05	2.4	20,30	680
APCA00101065101□80	100	100kHz,0.25V	150±20%	1.65	1.9	20,30	101
APCA00101065151□80	150	100kHz,0.25V	240±20%	1.35	1.5	20,30	151
APCA00101065221□80	220	100kHz,0.25V	350±20%	1.1	1.2	20,30	221
APCA00101065331□80	330	100kHz,0.25V	445±20%	0.9	1.1	20,30	331
APCA00101065471□80	470	100kHz,0.25V	600±20%	0.75	0.9	20,30	471

Note: When ordering, please specify tolerance code. Tolerance: M=±20% / T=±30%

1. Operating temperature range $-40^{\circ}\text{C} \sim 165^{\circ}\text{C}$ (Including self - temperature rise)
2. Isat for Inductance drop 30% from its value without current
3. I rms for a 40°C temperature rise from 25°C ambient.
4. Measure Equipment:

L: HP4284+42841A

RDC: Chroma 16502

Isat:WK3255BQ+ WK3265B

I rms: WK3255BQ+ WK3265B

APCA00121280 Type

■ Dimensions

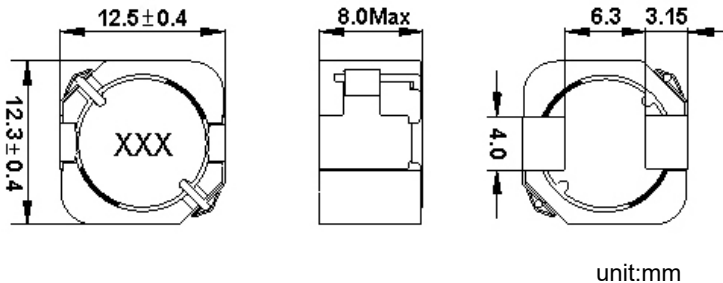

■ Recommended Land Pattern

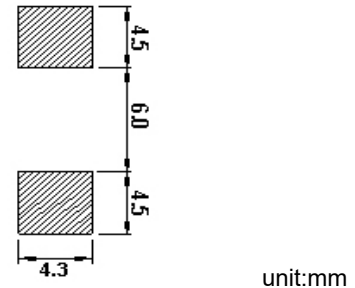

■ Electrical Characteristics

Part No.	Inductance (uH)	Test Freq.	RDC (mΩ)	Isat (A)Typ	Irms (A)Typ	Tolerance (±%)	Marking
APCA001212801R5□80	1.5	100kHz,0.25V	5.5±30%	23.5	10.5	30	1R5
APCA001212802R2□80	2.2	100kHz,0.25V	6.3±30%	20	9.7	30	2R2
APCA001212803R3□80	3.3	100kHz,0.25V	7.7±30%	15	9.5	30	3R3
APCA001212804R7□80	4.7	100kHz,0.25V	8.7±30%	13	9	30	4R7
APCA001212806R8□80	6.8	100kHz,0.25V	10±20%	9.7	8.5	30	6R8
APCA00121280100□80	10	100kHz,0.25V	12±20%	9.2	7.7	20,30	100
APCA00121280150□80	15	100kHz,0.25V	24±20%	7.4	5.1	20,30	150
APCA00121280220□80	22	100kHz,0.25V	27±20%	5.8	4.5	20,30	220
APCA00121280330□80	33	100kHz,0.25V	52±20%	4.5	3.6	20,30	330
APCA00121280470□80	47	100kHz,0.25V	66±20%	4.2	3.2	20,30	470
APCA00121280680□80	68	100kHz,0.25V	90±20%	3.6	2.7	20,30	680
APCA00121280101□80	100	100kHz,0.25V	110±20%	2.9	2.6	20,30	101
APCA00121280151□80	150	100kHz,0.25V	170±20%	2.4	2.1	20,30	151
APCA00121280221□80	220	100kHz,0.25V	280±20%	1.95	1.6	20,30	221
APCA00121280331□80	330	100kHz,0.25V	410±20%	1.6	1.25	20,30	331
APCA00121280471□80	470	100kHz,0.25V	590±20%	1.3	1.1	20,30	471

Note: When ordering, please specify tolerance code. Tolerance: M=±20% / T=±30%

1. Operating temperature range -40°C ~ 165°C (Including self - temperature rise)

2. Isat for Inductance drop 30% from its value without current

3. I rms for a 40°C temprature rise from 25°C ambient.

4. Measure Equipment:

L: HP4284+42841A

RDC: Chroma 16502

Isat:WK3255BQ+ WK3265B

I rms: WK3255BQ+ WK3265B

■ Packaging

Tape Dimensions

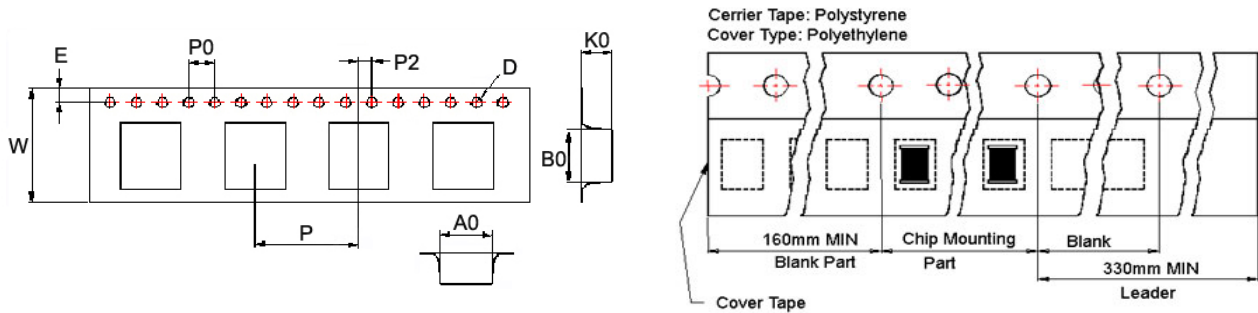

Reel Dimensions

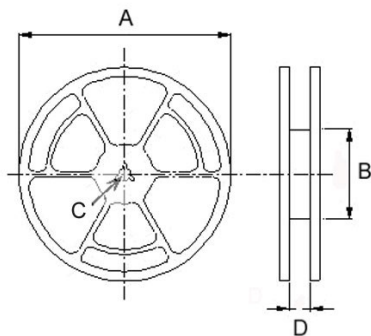

Dimensions in mm

TYPE	Tape Dimensions									Reel Dimensions				Quantity
	A0	B0	K0	D	E	W	P	P0	P2	A	B	C	D	PCS / REEL
APCA00060645	6.9	6.3	5	1.55	1.75	16	12	4	2	330	100	13	16	1000
APCA00070745	7.7	7.35	5	1.55	1.75	16	12	4	2	330	100	13	16	1000
APCA00101065	10.4	10.65	6.7	1.50	1.75	24	16	4	2	330	100	13	24	500
APCA00121280	12.8	13	8.7	1.50	1.75	24	16	4	2	330	100	13	24	400

Please be sure to request approval specifications that provide further details of the products. Kindly note that the content of these specifications are subject to change or may be discontinued without prior notice. This product may not be designed/used in medical or high risk applications without Chilisin approval. Please contact our sales department before ordering.

单击下面可查看定价，库存，交付和生命周期等信息

[>>CHILISIN\(奇力新\)](#)