

BPSD Series



Features

- RoHS, Halogen Free and REACH Compliance
- Unshielded power inductor
- Various package size and wide inductance range

Applications

- Graphic cards
- DC/DC converters

Product Identification

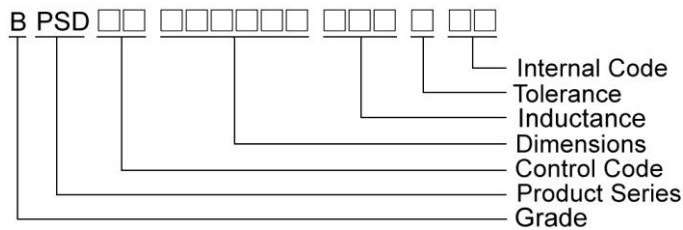

Shape and Dimensions

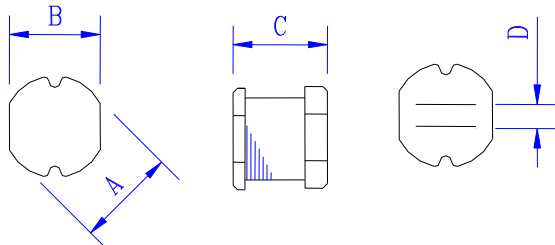

Recommended Pattern

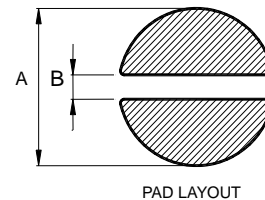

Dimensions in mm

TYPE	A	B	C	D
BPSD00030315	3.3±0.3	3.0±0.3	1.5±0.3	1.0
BPSD00030321	3.3±0.3	3.0±0.3	2.1±0.3	1.0
BPSD00050432	4.5±0.3	4.0±0.3	3.2±0.3	1.2
BPSD00060525	5.8±0.3	5.2±0.3	2.5±0.3	2.0
BPSD00060530	5.8±0.3	5.2±0.3	3±0.3	2.0
BPSD00060545	5.8±0.3	5.2±0.3	4.5±0.4	1.3
BPSD00080735	7.8±0.3	7.0±0.3	3.5±0.3	2.1
BPSD00080750	7.8±0.3	7.0±0.3	5.0±0.3	2.1
BPSD00109040	10.0±0.3	9.0±0.3	4.0±0.5	2.1
BPSD00100954	10.0±0.4	9.0±0.4	5.4±0.4	2.1
BPSD00100965	10.0±0.4	9.0±0.4	6.5±0.4	2.1

Dimensions in mm

Dim	A	B
BPSD00030315	4.5	1.0
BPSD00030321	4.5	1.0
BPSD00050432	5.5	1.2
BPSD00060525	6.8	2.0
BPSD00060530	6.8	2.0
BPSD00060545	6.8	1.3
BPSD00080735	8.8	2.1
BPSD00080750	8.8	2.1
BPSD00109040	11	2.1
BPSD00100954	11	2.1
BPSD00100965	11	2.1

Electrical Characteristics

Part Number	Inductance (μ H)	Tolerance (\pm %)	Test Frequency	RDC (Ω)	Isat (A)	Irms (A)	Marking
BPSD000303152R2□00	2.2	20	1 MHz, 1 V	0.10 \pm 30%	0.79	1	CC
BPSD000303153R3□00	3.3	20	1 MHz, 1 V	0.11 \pm 30%	0.73	0.97	DD
BPSD000303154R7□00	4.7	20	1 MHz, 1 V	0.15 \pm 30%	0.65	0.93	EH
BPSD000303155R6□00	5.6	20	1 MHz, 1 V	0.15 \pm 30%	0.6	0.9	FG
BPSD000303156R8□00	6.8	20	1 MHz, 1 V	0.20 \pm 30%	0.77	0.85	GI
BPSD00030315100□00	10	20	1 MHz, 1 V	0.30 \pm 30%	0.45	0.52	KA
BPSD00030315150□00	15	20	1 MHz, 1 V	0.58 \pm 30%	0.3	0.35	MA
BPSD00030315220□00	22	10,20	1 MHz, 1 V	0.71 \pm 30%	0.25	0.29	LA
BPSD00030315330□00	33	20	1 MHz, 1 V	1.10 \pm 30%	0.2	0.23	NA
BPSD00030315390□00	39	20	1 MHz, 1 V	1.30 \pm 30%	0.17	0.2	PA
BPSD00030315470□00	47	20	1 MHz, 1 V	1.30 \pm 30%	0.17	0.2	OA
BPSD00030315680□00	68	20	1 MHz, 1 V	2.20 \pm 30%	0.13	0.15	VA
BPSD00030315101□00	100	20	1 MHz, 1 V	3.50 \pm 30%	0.1	0.12	KB
BPSD00030315221□00	220	20	1 MHz, 1 V	10.92Max	0.07	0.08	LB

Note: When ordering, please specify tolerance code. Tolerance: K= \pm 10% , M= \pm 20%

- Operating temperature range – 40°C ~ 125°C (Including self - temperature rise)
- Isat for Inductance drop 10% from its value without current
- Irms for a 40°C temperature rise from 25°C ambient.
- Measure Equipment :
 - L : Agilent/ E4980 or HP4284A (under 1MHz), HP4285A (over 1MHz)
 - SRF : HP4286A
 - RDC : Chroma 16502
 - Isat : HP4284+42841A or WK3260B+WK3265B
 - Irms: WK3255BQ+ WK3265B (or equivalent)

Electrical Characteristics

Part Number	Inductance (μ H)	Tolerance ($\pm\%$)	Test Frequency	RDC (Ω)Max	Isat (A)	Irms (A)	Marking
BPSD00030321R82□00	0.82	30	7.96 MHz,1 V	0.06	2.2	2.53	AX
BPSD000303211R0□00	1	20	7.96 MHz,1 V	0.07	2.08	2.39	BA
BPSD000303211R2□00	1.2	20	7.96 MHz,1 V	0.08	2	2.30	BC
BPSD000303211R4□00	1.4	20	7.96 MHz,1 V	0.09	1.86	2.14	BE
BPSD000303211R5□00	1.5	20	7.96 MHz,1 V	0.11	1.8	2.07	BF
BPSD000303211R8□00	1.8	20	7.96 MHz,1 V	0.11	1.8	2.07	BI
BPSD000303212R2□00	2.2	20	7.96 MHz,1 V	0.13	1.39	1.60	CC
BPSD000303212R7□00	2.7	20	7.96 MHz,1 V	0.14	1.32	1.52	CH
BPSD000303213R3□00	3.3	10,20	7.96 MHz,1 V	0.17	1.25	1.44	DD
BPSD000303213R9□00	3.9	20	7.96 MHz,1 V	0.19	1.2	1.38	DJ
BPSD000303214R7□00	4.7	20	7.96 MHz,1 V	0.21	1.13	1.30	EH
BPSD000303215R6□00	5.6	20	7.96 MHz,1 V	0.22	0.91	1.05	FG
BPSD000303216R8□00	6.8	20	7.96 MHz,1 V	0.25	0.85	0.98	GI
BPSD000303217R0□00	7	20	7.96 MHz,1 V	0.28	0.82	0.94	HA
BPSD000303218R2□00	8.2	20	7.96 MHz,1 V	0.28	0.82	0.94	IC
BPSD00030321100□00	10	10,20	2.52 MHz,1 V	0.32	0.74	0.85	KA
BPSD00030321120□00	12	20	2.52 MHz,1 V	0.35	0.64	0.74	QA
BPSD00030321150□00	15	20	2.52 MHz,1 V	0.4	0.6	0.69	MA
BPSD00030321180□00	18	20	2.52 MHz,1 V	0.48	0.54	0.62	RA
BPSD00030321220□00	22	10,20	2.52 MHz,1 V	0.58	0.5	0.58	LA
BPSD00030321270□00	27	20	2.52 MHz,1 V	0.65	0.43	0.49	SA
BPSD00030321330□00	33	20	2.52 MHz,1 V	0.8	0.4	0.46	NA
BPSD00030321390□00	39	20	2.52 MHz,1 V	0.9	0.37	0.43	PA
BPSD00030321470□00	47	20	2.52 MHz,1 V	1.19	0.36	0.41	OA
BPSD00030321500□00	50	20	2.52 MHz,1 V	1.22	0.33	0.38	TA
BPSD00030321560□00	56	20	2.52 MHz,1 V	1.27	0.31	0.36	UA
BPSD00030321680□00	68	10,20	2.52 MHz,1 V	1.73	0.3	0.35	VA
BPSD00030321750□00	75	20	2.52 MHz,1 V	1.9	0.29	0.33	WA

Note: When ordering, please specify tolerance code. Tolerance: K= $\pm 10\%$, M= $\pm 20\%$, T= $\pm 30\%$

- Operating temperature range – 40°C ~ 125°C (Including self - temperature rise)
- Isat for Inductance drop 10% from its value without current
- I rms for a 40°C temperature rise from 25°C ambient.
- Measure Equipment :
 L : Agilent/ E4980 or HP4284A (under 1MHz), HP4285A (over 1MHz)
 SRF : HP4286A
 RDC : Chroma 16502
 Isat : HP4284+42841A or WK3260B+WK3265B
 I rms: WK3255BQ+ WK3265B (or equivalent)

Please be sure to request approval specifications that provide further details of the products. Kindly note that the content of these specifications are subject to change or may be discontinued without prior notice. This product may not be designed/used in medical or high risk applications without Chilisin approval. Please contact our sales department before ordering.

Electrical Characteristics

Part Number	Inductance (μ H)	Tolerance (\pm %)	Test Frequency	RDC (Ω)Max	Isat (A)	Irms (A)	Marking
BPSD00030321820□00	82	10,20	2.52 MHz, 1 V	1.99	0.28	0.32	XA
BPSD00030321101□00	100	10,20	1 kHz, 1 V	2.52	0.25	0.29	KB
BPSD00030321121□00	120	10,20	1 kHz, 1 V	2.9	0.2	0.23	QB
BPSD00030321151□00	150	20	1 kHz, 1 V	3.36	0.19	0.22	MB
BPSD00030321181□00	180	20	1 kHz, 1 V	5.1	0.17	0.20	RB
BPSD00030321221□00	220	10,20	1 kHz, 1 V	5.8	0.16	0.18	LB
BPSD00030321271□00	270	10,20	1 kHz, 1 V	7.8	0.14	0.16	SB

Note: When ordering, please specify tolerance code. Tolerance: K= \pm 10% , M= \pm 20% , T= \pm 30%

- Operating temperature range—40°C ~ 125°C (Including self - temperature rise)
- Isat for Inductance drop 10% from its value without current
- I rms for a 40°C temperature rise from 25°C ambient.
- Measure Equipment :

L : Agilent/ E4980 or HP4284A (under 1MHz), HP4285A (over 1MHz)

SRF : HP4286A

RDC : Chroma 16502

Isat : HP4284+42841A or WK3260B+WK3265B

I rms: WK3255BQ+ WK3265B (or equivalent)

Electrical Characteristics

Part Number	Inductance (μ H)	Tolerance (\pm %)	Test Frequency	RDC (Ω)Max	Isat (A)	Marking
BPSD00050432R15□00	0.15	30	7.96 MHz, 1 V	0.0085	7.5	R15
BPSD000504321R0□00	1.0	10,20	7.96 MHz, 1 V	0.033	3.8	1R0
BPSD000504321R2□00	1.2	20	7.96 MHz, 1 V	0.035	3.5	1R2
BPSD000504321R4□00	1.4	20	7.96 MHz, 1 V	0.038	3.3	1R4
BPSD000504321R8□00	1.8	10,20	7.96 MHz, 1 V	0.042	2.91	1R8
BPSD000504322R2□00	2.2	10,20	7.96 MHz, 1 V	0.047	2.6	2R2
BPSD000504322R7□00	2.7	20	7.96 MHz, 1 V	0.052	2.43	2R7
BPSD000504323R3□00	3.3	10,20	7.96 MHz, 1 V	0.058	2.15	3R3
BPSD000504323R9□00	3.9	20	7.96 MHz, 1 V	0.076	1.98	3R9
BPSD000504324R7□00	4.7	10,20	7.96 MHz, 1 V	0.094	1.7	4R7
BPSD000504325R6□00	5.6	10,20	7.96 MHz, 1 V	0.101	1.6	5R6
BPSD000504326R2□00	6.2	20	7.96 MHz, 1 V	0.11	1.5	6R2
BPSD000504326R8□00	6.8	10,20	7.96 MHz, 1 V	0.117	1.41	6R8
BPSD000504328R2□00	8.2	10,20	7.96 MHz, 1 V	0.132	1.26	8R2
BPSD00050432100□00	10	10,20	2.52 MHz, 1 V	0.182	1.15	100
BPSD00050432120□00	12	20	2.52 MHz, 1 V	0.21	1.05	120
BPSD00050432150□00	15	10,20	2.52 MHz, 1 V	0.235	0.92	150
BPSD00050432180□00	18	20	2.52 MHz, 1 V	0.338	0.84	180
BPSD00050432220□00	22	10,20	2.52 MHz, 1 V	0.378	0.76	220
BPSD00050432270□00	27	10,20	2.52 MHz, 1 V	0.522	0.71	270
BPSD00050432330□00	33	10,20	2.52 MHz, 1 V	0.54	0.64	330
BPSD00050432390□00	39	10,20	2.52 MHz, 1 V	0.587	0.59	390
BPSD00050432470□00	47	10,20	2.52 MHz, 1 V	0.844	0.54	470
BPSD00050432560□00	56	10,20	2.52 MHz, 1 V	0.937	0.5	560
BPSD00050432680□00	68	10,20	2.52 MHz, 1 V	1.117	0.46	680
BPSD00050432101□00	100	10,20	1kHz, 1 V	2	0.4	101
BPSD00050432121□00	120	10,20	1kHz, 1 V	1.8	0.38	121
BPSD00050432151□00	150	10,20	1kHz, 1 V	2.8	0.3	151
BPSD00050432181□00	180	10,20	1kHz, 1 V	3.2	0.25	181
BPSD0005043221□00	220	10,20	1kHz, 1 V	4	0.15	221
BPSD00050432331□00	330	10,20	1kHz, 1 V	5.85	0.21	331

Note: When ordering, please specify tolerance code. Tolerance: K= \pm 10% , M= \pm 20% , T= \pm 30%

- Operating temperature range – 40°C ~ 125°C (Including self - temperature rise)
- Isat for Inductance drop 10% from its value without current
- Measure Equipment :
 L : Agilent/ E4980 or HP4284A (under 1MHz), HP4285A (over 1MHz)
 SRF : HP4286A
 RDC : Chroma 16502
 Isat : HP4284+42841A or WK3260B+WK3265B

Please be sure to request approval specifications that provide further details of the products. Kindly note that the content of these specifications are subject to change or may be discontinued without prior notice. This product may not be designed/used in medical or high risk applications without Chilisin approval. Please contact our sales department before ordering.

SMD Shielded Power Inductors – BPSD Series

Electrical Characteristics

Part Number	Inductance (μ H)	Tolerance (\pm %)	Test Frequency	RDC (Ω)Max	Isat (A)	Marking
BPSD000605251R0□00	1	20	7.96 MHz, 1 V	0.03	4.5	1R0
BPSD000605251R4□00	1.4	20	7.96 MHz, 1 V	0.04	4	1R4
BPSD000605251R8□00	1.8	20	7.96 MHz, 1 V	0.05	3.3	1R8
BPSD000605252R2□00	2.2	20	7.96 MHz, 1 V	0.06	2.94	2R2
BPSD000605252R7□00	2.7	20	7.96 MHz, 1 V	0.07	2.5	2R7
BPSD000605253R3□00	3.3	20	7.96 MHz, 1 V	0.08	2.35	3R3
BPSD000605253R9□00	3.9	20	7.96 MHz, 1 V	0.09	2.2	3R9
BPSD000605254R7□00	4.7	10,20	7.96 MHz, 1 V	0.14	2	4R7
BPSD000605255R6□00	5.6	20	7.96 MHz, 1 V	0.15	1.8	5R6
BPSD000605256R8□00	6.8	20	7.96 MHz, 1 V	0.16	1.7	6R8
BPSD000605258R2□00	8.2	20	7.96 MHz, 1 V	0.17	1.4	8R2
BPSD00060525100□00	10	10,20	2.52 MHz, 1 V	0.18	1.2	100
BPSD00060525120□00	12	20	2.52 MHz, 1 V	0.2	1.18	120
BPSD00060525150□00	15	20	2.52 MHz, 1 V	0.22	1.15	150
BPSD00060525180□00	18	20	2.52 MHz, 1 V	0.25	1.1	180
BPSD00060525220□00	22	10,20	2.52 MHz, 1 V	0.35	1	220
BPSD00060525270□00	27	20	2.52 MHz, 1 V	0.45	0.86	270
BPSD00060525330□00	33	10,20	2.52 MHz, 1 V	0.56	0.76	330
BPSD00060525390□00	39	10,20	2.52 MHz, 1 V	0.69	0.75	390
BPSD00060525470□00	47	10,20	2.52 MHz, 1 V	0.72	0.73	470
BPSD00060525560□00	56	10,20	2.52 MHz, 1 V	0.84	0.55	560
BPSD00060525680□00	68	10,20	2.52 MHz, 1 V	0.9	0.52	680
BPSD00060525820□00	82	10,20	2.52 MHz, 1 V	1.2	0.5	820
BPSD00060525101□00	100	10,20	1 kHz, 1 V	1.3	0.4	101
BPSD00060525121□00	120	10,20	1 kHz, 1 V	1.38	0.36	121
BPSD00060525151□00	150	10,20	1 kHz, 1 V	1.81	0.3	151
BPSD00060525181□00	180	10,20	1 kHz, 1 V	1.95	0.26	181
BPSD00060525221□00	220	10,20	1 kHz, 1 V	3	0.25	221

Note: When ordering, please specify tolerance code. Tolerance: K= \pm 10% , M= \pm 20%

- Operating temperature range –40°C ~ 125°C (Including self - temperature rise)
- Isat for Inductance drop 10% from its value without current
- Measure Equipment :
 L : Agilent/ E4980 or HP4284A (under 1MHz), HP4285A (over 1MHz)
 SRF : HP4286A
 RDC : Chroma 16502
 Isat : HP4284+42841A or WK3260B+WK3265B

Please be sure to request approval specifications that provide further details of the products. Kindly note that the content of these specifications are subject to change or may be discontinued without prior notice. This product may not be designed/used in medical or high risk applications without Chilisin approval. Please contact our sales department before ordering.

Electrical Characteristics

Part Number	Inductance (μ H)	Tolerance (\pm %)	Test Frequency	RDC (Ω)Max	Isat (A)	Marking
BPSD00060525271□00	270	10,20	1 kHz,1 V	3.2	0.21	271
BPSD00060525331□00	330	10,20	1 kHz,1 V	3.82	0.18	331
BPSD00060525391□00	390	10,20	1 kHz,1 V	4.68	0.16	391
BPSD00060525471□00	470	10,20	1 kHz,1 V	5.1	0.15	471
BPSD00060525561□00	560	10,20	1 kHz,1 V	8.5	0.14	561
BPSD00060525681□00	680	10,20	1 kHz,1 V	10	0.13	681
BPSD00060525821□00	820	10,20	1 kHz,1 V	12	0.07	821
BPSD00060525102□00	1000	10,20	1 kHz,1 V	18	0.05	102

Note: When ordering, please specify tolerance code. Tolerance: K= \pm 10% , M= \pm 20%

- Operating temperature range—40°C ~ 125°C (Including self - temperature rise)
- Isat for Inductance drop 10% from its value without current
- Measure Equipment :
 L : Agilent/ E4980 or HP4284A (under 1MHz), HP4285A (over 1MHz)
 SRF : HP4286A
 RDC : Chroma 16502
 Isat : HP4284+42841A or WK3260B+WK3265B

Electrical Characteristics

Part Number	Inductance (μ H)	Tolerance (\pm %)	Test Frequency	RDC (Ω)Max	Isat (A)	Marking
BPSD000605301R0□00	1.0	20	7.96 MHz, 1 V	0.03	4.5	1R0
BPSD000605301R2□00	1.2	20	7.96 MHz, 1 V	0.03	4.2	1R2
BPSD000605301R5□00	1.5	20	7.96 MHz, 1 V	0.03	4.1	1R5
BPSD000605301R8□00	1.8	10,20	7.96 MHz, 1 V	0.03	3.7	1R8
BPSD000605302R0□00	2	20	7.96 MHz, 1 V	0.03	3.6	2R0
BPSD000605302R2□00	2.2	20	7.96 MHz, 1 V	0.03	3.5	2R2
BPSD000605302R7□00	2.7	20	7.96 MHz, 1 V	0.04	3.2	2R7
BPSD000605303R3□00	3.3	10,20	7.96 MHz, 1 V	0.05	2.8	3R3
BPSD000605303R9□00	3.9	20	7.96 MHz, 1 V	0.06	2.6	3R9
BPSD000605304R7□00	4.7	10,20	7.96 MHz, 1 V	0.07	2.5	4R7
BPSD000605305R6□00	5.6	20	7.96 MHz, 1 V	0.08	2.4	5R6
BPSD000605306R8□00	6.8	20	7.96 MHz, 1 V	0.09	2.2	6R8
BPSD000605308R2□00	8.2	20	7.96 MHz, 1 V	0.1	2	8R2
BPSD00060530100□00	10	10,20	2.52 MHz, 1 V	0.12	1.8	100
BPSD00060530120□00	12	10,20	2.52 MHz, 1 V	0.13	1.75	120
BPSD00060530150□00	15	10,20	2.52 MHz, 1 V	0.15	1.7	150
BPSD00060530180□00	18	10,20	2.52 MHz, 1 V	0.22	1.6	180
BPSD00060530220□00	22	10,20	2.52 MHz, 1 V	0.22	1.5	220
BPSD00060530270□00	27	20	2.52 MHz, 1 V	0.26	1.4	270
BPSD00060530330□00	33	10,20	2.52 MHz, 1 V	0.33	1.1	330
BPSD00060530390□00	39	10,20	2.52 MHz, 1 V	0.42	1	390
BPSD00060530470□00	47	10,20	2.52 MHz, 1 V	0.5	0.9	470
BPSD00060530560□00	56	10,20	2.52 MHz, 1 V	0.55	0.85	560
BPSD00060530680□00	68	10,20	2.52 MHz, 1 V	0.65	0.8	680
BPSD00060530820□00	82	10,20	2.52 MHz, 1 V	0.8	0.65	820
BPSD00060530101□00	100	10,20	1 kHz, 1 V	0.9	0.6	101
BPSD00060530121□00	120	10,20	1 kHz, 1 V	1	0.58	121
BPSD00060530151□00	150	10,20	1 kHz, 1 V	1.3	0.43	151

Note: When ordering, please specify tolerance code. Tolerance: K= \pm 10% , M= \pm 20%

- Operating temperature range –40°C ~ 125°C (Including self - temperature rise)
- Isat for Inductance drop 10% from its value without current
- Measure Equipment :
 - L : Agilent/ E4980 or HP4284A (under 1MHz), HP4285A (over 1MHz)
 - SRF : HP4286A
 - RDC : Chroma 16502
 - Isat : HP4284+42841A or WK3260B+WK3265B

Please be sure to request approval specifications that provide further details of the products. Kindly note that the content of these specifications are subject to change or may be discontinued without prior notice. This product may not be designed/used in medical or high risk applications without Chilisin approval. Please contact our sales department before ordering.

Electrical Characteristics

Part Number	Inductance (μ H)	Tolerance (\pm %)	Test Frequency	RDC (Ω)Max	Isat (A)	Marking
BPSD00060530181□00	180	10,20	1 kHz,1 V	1.5	0.41	181
BPSD00060530221□00	220	10,20	1 kHz,1 V	2	0.38	221
BPSD00060530271□00	270	10,20	1 kHz,1 V	2.5	0.35	271
BPSD00060530331□00	330	10,20	1 kHz,1 V	3.2	0.28	331
BPSD00060530391□00	390	10,20	1 kHz,1 V	3.5	0.26	391
BPSD00060530471□00	470	10,20	1 kHz,1 V	4.2	0.2	471
BPSD00060530561□00	560	10,20	1 kHz,1 V	4.5	0.19	561
BPSD00060530681□00	680	10,20	1 kHz,1 V	6.5	0.18	681
BPSD00060530821□00	820	10,20	1 kHz,1 V	7.5	0.15	821
BPSD00060530102□00	1000	10,20	1 kHz,1 V	8	0.13	102

Note: When ordering, please specify tolerance code. Tolerance: K= \pm 10% , M= \pm 20%

- Operating temperature range – 40°C ~ 125°C (Including self - temperature rise)
- Isat for Inductance drop 10% from its value without current
- Measure Equipment :
 - L : Agilent/ E4980 or HP4284A (under 1MHz), HP4285A (over 1MHz)
 - SRF : HP4286A
 - RDC : Chroma 16502
 - Isat : HP4284+42841A or WK3260B+WK3265B

SMD Shielded Power Inductors – BPSD Series

Electrical Characteristics

Part Number	Inductance (μ H)	Tolerance (\pm %)	Test Frequency	RDC (Ω)Max	Isat (A)	Marking
BPSD000605451R8□00	1.8	20	7.96 MHz, 1 V	0.02	3.5	1R8
BPSD000605452R2□00	2.2	20	7.96 MHz, 1 V	0.023	3.2	2R2
BPSD000605453R3□00	3.3	10,20	7.96 MHz, 1 V	0.0314	2.59	3R3
BPSD000605453R5□00	3.5	20	7.96 MHz, 1 V	0.03	2.4	3R5
BPSD000605454R7□00	4.7	10,20	7.96 MHz, 1 V	0.0372	2.3	4R7
BPSD000605456R8□00	6.8	20	7.96 MHz, 1 V	0.057	1.8	6R8
BPSD000605458R2□00	8.2	20	7.96 MHz, 1 V	0.0594	1.7	8R2
BPSD00060545100□00	10	10,20	2.52 MHz, 1 V	0.1	1.44	100
BPSD00060545120□00	12	20	2.52 MHz, 1 V	0.12	1.4	120
BPSD00060545150□00	15	10,20	2.52 MHz, 1 V	0.14	1.3	150
BPSD00060545180□00	18	20	2.52 MHz, 1 V	0.15	1.23	180
BPSD00060545220□00	22	20	2.52 MHz, 1 V	0.18	1.11	220
BPSD00060545270□00	27	20	2.52 MHz, 1 V	0.2	0.97	270
BPSD00060545330□00	33	10,20	2.52 MHz, 1 V	0.23	0.88	330
BPSD00060545390□00	39	10,20	2.52 MHz, 1 V	0.32	0.8	390
BPSD00060545470□00	47	10,20	2.52 MHz, 1 V	0.37	0.72	470
BPSD00060545560□00	56	10,20	2.52 MHz, 1 V	0.42	0.68	560
BPSD00060545680□00	68	10,20	2.52 MHz, 1 V	0.46	0.61	680
BPSD00060545820□00	82	10,20	2.52 MHz, 1 V	0.6	0.58	820
BPSD00060545101□00	100	10,20	1 kHz, 1 V	0.7	0.52	101
BPSD00060545121□00	120	10,20	1 kHz, 1 V	0.93	0.48	121
BPSD00060545151□00	150	10,20	1 kHz, 1 V	1.1	0.4	151
BPSD00060545181□00	180	10,20	1 kHz, 1 V	1.38	0.38	181
BPSD00060545221□00	220	10,20	1 kHz, 1 V	1.57	0.35	221
BPSD00060545271□00	270	10,20	1 kHz, 1 V	1.85	0.29	271
BPSD00060545331□00	330	10,20	1 kHz, 1 V	2	0.28	331
BPSD00060545391□00	390	10,20	1 kHz, 1 V	2.6	0.26	391
BPSD00060545471□00	470	10,20	1 kHz, 1 V	3	0.12	471

Note: When ordering, please specify tolerance code. Tolerance: K= \pm 10% , M= \pm 20%

- Operating temperature range –40°C ~ 125°C (Including self - temperature rise)
- Isat for Inductance drop 10% from its value without current
- Measure Equipment :
 L : Agilent/ E4980 or HP4284A (under 1MHz), HP4285A (over 1MHz)
 SRF : HP4286A
 RDC : Chroma 16502
 Isat : HP4284+42841A or WK3260B+WK3265B

Please be sure to request approval specifications that provide further details of the products. Kindly note that the content of these specifications are subject to change or may be discontinued without prior notice. This product may not be designed/used in medical or high risk applications without Chilisin approval. Please contact our sales department before ordering.

Electrical Characteristics

Part Number	Inductance (μ H)	Tolerance (\pm %)	Test Frequency	RDC (Ω)Max	Isat (A)	Marking
BPSD00060545561□00	560	10,20	1 kHz,1 V	4.19	0.1	561
BPSD00060545681□00	680	10,20	1 kHz,1 V	4.44	0.08	681
BPSD00060545821□00	820	10,20	1 kHz,1 V	5.12	0.05	821
BPSD00060545102□00	1000	10,20	1 kHz,1 V	10	0.03	102
BPSD00060545152□00	1500	10,20	1 kHz,1V	11	0.03	152
BPSD00060545182□00	1800	10,20	1 kHz,1V	12.3	0.03	182
BPSD00060545202□00	2000	10,20	1 kHz,1V	12.6	0.03	202
BPSD00060545222□00	2200	10,20	1 kHz,1V	12.9	0.03	222

Note: When ordering, please specify tolerance code. Tolerance: K= \pm 10% , M= \pm 20%

- Operating temperature range—40°C ~ 125°C (Including self - temperature rise)
- Isat for Inductance drop 10% from its value without current
- Measure Equipment :
 L : Agilent/ E4980 or HP4284A (under 1MHz), HP4285A (over 1MHz)
 SRF : HP4286A
 RDC : Chroma 16502
 Isat : HP4284+42841A or WK3260B+WK3265B

Electrical Characteristics

Part Number	Inductance (μ H)	Tolerance (\pm %)	Test Frequency	RDC (Ω)Max	Isat (A)	Marking
BPSD000807352R2□00	2.2	20	7.96 MHz, 1 V	0.03	3.2	2R2
BPSD000807354R7□00	4.7	20	2.52 MHz, 1 V	0.04	1.6	4R7
BPSD00080735100□00	10	20	2.52 MHz, 1 V	0.08	1.44	100
BPSD00080735120□00	12	10,20	2.52 MHz, 1 V	0.09	1.39	120
BPSD00080735150□00	15	10,20	2.52 MHz, 1 V	0.1	1.24	150
BPSD00080735180□00	18	20	2.52 MHz, 1 V	0.11	1.12	180
BPSD00080735220□00	22	20	2.52 MHz, 1 V	0.13	1.07	220
BPSD00080735270□00	27	20	2.52 MHz, 1 V	0.15	0.94	270
BPSD00080735330□00	33	10,20	2.52 MHz, 1 V	0.17	0.85	330
BPSD00080735390□00	39	10,20	2.52 MHz, 1 V	0.22	0.74	390
BPSD00080735470□00	47	10,20	2.52 MHz, 1 V	0.25	0.68	470
BPSD00080735560□00	56	10,20	2.52 MHz, 1 V	0.28	0.64	560
BPSD00080735680□00	68	10,20	2.52 MHz, 1 V	0.33	0.59	680
BPSD00080735820□00	82	10,20	2.52 MHz, 1 V	0.41	0.54	820
BPSD00080735101□00	100	10,20	1 kHz, 1 V	0.48	0.51	101
BPSD00080735121□00	120	10,20	1 kHz, 1 V	0.54	0.49	121
BPSD00080735151□00	150	10,20	1 kHz, 1 V	0.75	0.4	151
BPSD00080735181□00	180	10,20	1 kHz, 1 V	1.02	0.36	181
BPSD00080735221□00	220	10,20	1 kHz, 1 V	1.2	0.31	221
BPSD00080735271□00	270	10,20	1 kHz, 1 V	1.31	0.29	271
BPSD00080735331□00	330	10,20	1 kHz, 1 V	1.5	0.28	331
BPSD00080735561□00	560	10,20	1 kHz, 1 V	2.5	0.14	561

Note: When ordering, please specify tolerance code. Tolerance: K= \pm 10% , M= \pm 20%

- Operating temperature range—40°C ~ 125°C (Including self - temperature rise)
- Isat for Inductance drop 10% from its value without current
- Measure Equipment :
 L : Agilent/ E4980 or HP4284A (under 1MHz), HP4285A (over 1MHz)
 SRF : HP4286A
 RDC : Chroma 16502
 Isat : HP4284+42841A or WK3260B+WK3265B

Electrical Characteristics

Part Number	Inductance (μ H)	Tolerance (\pm %)	Test Frequency	RDC (Ω)Max	Isat (A)	Marking
BPSD000807501R4□00	1.4	20	7.96 MHz, 1 V	0.02	3.7	1R4
BPSD000807501R5□00	1.5	20	7.96 MHz, 1 V	0.02	3.7	1R5
BPSD000807501R8□00	1.8	20	7.96 MHz, 1 V	0.02	3.7	1R8
BPSD000807502R2□00	2.2	20	7.96 MHz, 1 V	0.02	3.7	2R2
BPSD000807502R7□00	2.7	20	7.96 MHz, 1 V	0.02	3.7	2R7
BPSD000807503R0□00	3	20	7.96 MHz, 1 V	0.025	3.7	3R0
BPSD000807503R3□00	3.3	20	7.96 MHz, 1 V	0.03	3.7	3R3
BPSD000807503R6□00	3.6	20	7.96 MHz, 1 V	0.03	3.7	3R6
BPSD000807503R9□00	3.9	20	7.96 MHz, 1 V	0.03	3.7	3R9
BPSD000807504R7□00	4.7	10,20	7.96 MHz, 1 V	0.04	3.5	4R7
BPSD000807505R6□00	5.6	20	7.96 MHz, 1 V	0.04	3.3	5R6
BPSD000807506R8□00	6.8	20	7.96 MHz, 1 V	0.04	3.1	6R8
BPSD000807508R2□00	8.2	20	7.96 MHz, 1 V	0.05	2.7	8R2
BPSD00080750100□00	10	10,20	2.52 MHz, 1 V	0.07	2.3	100
BPSD00080750120□00	12	20	2.52 MHz, 1 V	0.08	2	120
BPSD00080750150□00	15	10,20	2.52 MHz, 1 V	0.09	1.8	150
BPSD00080750180□00	18	20	2.52 MHz, 1 V	0.1	1.6	180
BPSD00080750220□00	22	10,20	2.52 MHz, 1 V	0.11	1.5	220
BPSD00080750270□00	27	20	2.52 MHz, 1 V	0.12	1.3	270
BPSD00080750330□00	33	10,20	2.52 MHz, 1 V	0.13	1.2	330
BPSD00080750390□00	39	10,20	2.52 MHz, 1 V	0.16	1.1	390
BPSD00080750470□00	47	10,20	2.52 MHz, 1 V	0.18	1.1	470
BPSD00080750560□00	56	10,20	2.52 MHz, 1 V	0.24	0.94	560
BPSD00080750680□00	68	10,20	2.52 MHz, 1 V	0.28	0.85	680
BPSD00080750820□00	82	10,20	2.52 MHz, 1 V	0.37	0.78	820
BPSD00080750101□00	100	10,20	1 kHz, 1 V	0.43	0.72	101
BPSD00080750121□00	120	10,20	1 kHz, 1 V	0.47	0.66	121
BPSD00080750151□00	150	10,20	1 kHz, 1 V	0.64	0.58	151

Note: When ordering, please specify tolerance code. Tolerance: K= \pm 10% , M= \pm 20%

- Operating temperature range –40°C ~ 125°C (Including self - temperature rise)
- Isat for Inductance drop 10% from its value without current
- Measure Equipment :
 L : Agilent/ E4980 or HP4284A (under 1MHz), HP4285A (over 1MHz)
 SRF : HP4286A
 RDC : Chroma 16502
 Isat : HP4284+42841A or WK3260B+WK3265B

Please be sure to request approval specifications that provide further details of the products. Kindly note that the content of these specifications are subject to change or may be discontinued without prior notice. This product may not be designed/used in medical or high risk applications without Chilisin approval. Please contact our sales department before ordering.

Electrical Characteristics

Part Number	Inductance (μ H)	Tolerance (\pm %)	Test Frequency	RDC (Ω)Max	Isat (A)	Marking
BPSD00080750181□00	180	10,20	1 kHz,1 V	0.71	0.51	181
BPSD00080750221□00	220	10,20	1 kHz,1 V	0.96	0.49	221
BPSD00080750271□00	270	10,20	1 kHz,1 V	1.11	0.42	271
BPSD00080750331□00	330	10,20	1 kHz,1 V	1.26	0.4	331
BPSD00080750391□00	390	10,20	1 kHz,1 V	1.77	0.36	391
BPSD00080750471□00	470	10,20	1 kHz,1 V	1.96	0.34	471
BPSD00080750561□00	560	10,20	1 kHz,1 V	2.41	0.32	561
BPSD00080750681□00	680	10,20	1 kHz,1 V	2.5	0.29	681
BPSD00080750102□00	1000	10,20	1 kHz,1 V	2.8	0.19	102

Note: When ordering, please specify tolerance code. Tolerance: K= \pm 10% , M= \pm 20%

- Operating temperature range – 40°C ~ 125°C (Including self - temperature rise)
- Isat for Inductance drop 10% from its value without current
- Measure Equipment :
 - L : Agilent/ E4980 or HP4284A (under 1MHz), HP4285A (over 1MHz)
 - SRF : HP4286A
 - RDC : Chroma 16502
 - Isat : HP4284+42841A or WK3260B+WK3265B

Electrical Characteristics

Part Number	Inductance (μ H)	Tolerance (\pm %)	Test Frequency	RDC (Ω)Max	Isat (A)	Marking
BPSD001009403R3□00	3.3	20	7.96 MHz, 1 V	0.022	4.5	3R3
BPSD001009403R8□00	3.8	20	7.96 MHz, 1 V	0.022	4.2	3R8
BPSD001009406R8□00	6.8	20	7.96 MHz, 1 V	0.04	3	6R8
BPSD00100940100□00	10	20	2.52 MHz, 1 V	0.05	2.38	100
BPSD00100940120□00	12	20	2.52 MHz, 1 V	0.06	2.13	120
BPSD00100940150□00	15	10,20	2.52 MHz, 1 V	0.07	1.87	150
BPSD00100940180□00	18	20	2.52 MHz, 1 V	0.08	1.73	180
BPSD00100940220□00	22	10,20	2.52 MHz, 1 V	0.09	1.6	220
BPSD00100940270□00	27	20	2.52 MHz, 1 V	0.1	1.44	270
BPSD00100940330□00	33	10,20	2.52 MHz, 1 V	0.12	1.26	330
BPSD00100940390□00	39	10,20	2.52 MHz, 1 V	0.15	1.2	390
BPSD00100940470□00	47	10,20	2.52 MHz, 1 V	0.17	1.1	470
BPSD00100940560□00	56	10,20	2.52 MHz, 1 V	0.2	1.01	560
BPSD00100940680□00	68	10,20	2.52 MHz, 1 V	0.22	0.91	680
BPSD00100940820□00	82	10,20	2.52 MHz, 1 V	0.3	0.85	820
BPSD00100940101□00	100	10,20	1 kHz, 1 V	0.34	0.74	101
BPSD00100940121□00	120	10,20	1 kHz, 1 V	0.4	0.69	121
BPSD00100940151□00	150	10,20	1 kHz, 1 V	0.54	0.61	151
BPSD00100940181□00	180	10,20	1 kHz, 1 V	0.62	0.56	181
BPSD00100940221□00	220	10,20	1 kHz, 1 V	0.72	0.53	221
BPSD00100940271□00	270	10,20	1 kHz, 1 V	0.95	0.45	271
BPSD00100940331□00	330	10,20	1 kHz, 1 V	1.1	0.42	331
BPSD00100940391□00	390	10,20	1 kHz, 1 V	1.24	0.38	391
BPSD00100940471□00	470	10,20	1 kHz, 1 V	1.53	0.35	471
BPSD00100940561□00	560	10,20	1 kHz, 1 V	1.9	0.32	561

Note: When ordering, please specify tolerance code. Tolerance: K= \pm 10% , M= \pm 20%

- Operating temperature range –40°C ~ 125°C (Including self - temperature rise)
- Isat for Inductance drop 10% from its value without current
- Measure Equipment :
 L : Agilent/ E4980 or HP4284A (under 1MHz), HP4285A (over 1MHz)
 SRF : HP4286A
 RDC : Chroma 16502
 Isat : HP4284+42841A or WK3260B+WK3265B

Electrical Characteristics

Part Number	Inductance (μ H)	Tolerance (\pm %)	Test Frequency	RDC (Ω)Max	Isat (A)	Marking
BPSD001009543R3□00	3.3	20	7.96 MHz, 1 V	0.038	2.8	3R3
BPSD001009544R7□00	4.7	20	7.96 MHz, 1 V	0.04	2.6	4R7
BPSD001009545R6□00	5.6	20	7.96 MHz, 1 V	0.037	4.5	5R6
BPSD001009546R8□00	6.8	20	7.96 MHz, 1 V	0.037	4.33	6R8
BPSD001009548R2□00	8.2	20	7.96 MHz, 1 V	0.05	3.5	8R2
BPSD00100954100□00	10	10,20	2.52 MHz, 1 V	0.06	2.6	100
BPSD00100954120□00	12	20	2.52 MHz, 1 V	0.07	2.45	120
BPSD00100954150□00	15	10,20	2.52 MHz, 1 V	0.08	2.27	150
BPSD00100954180□00	18	20	2.52 MHz, 1 V	0.09	2.15	180
BPSD00100954220□00	22	10,20	2.52 MHz, 1 V	0.1	1.95	220
BPSD00100954270□00	27	10,20	2.52 MHz, 1 V	0.11	1.76	270
BPSD00100954330□00	33	10,20	2.52 MHz, 1 V	0.12	1.5	330
BPSD00100954390□00	39	10,20	2.52 MHz, 1 V	0.14	1.37	390
BPSD00100954470□00	47	10,20	2.52 MHz, 1 V	0.17	1.28	470
BPSD00100954560□00	56	10,20	2.52 MHz, 1 V	0.19	1.17	560
BPSD00100954680□00	68	10,20	2.52 MHz, 1 V	0.22	1.11	680
BPSD00100954820□00	82	10,20	2.52 MHz, 1 V	0.25	1	820
BPSD00100954101□00	100	10,20	1 kHz, 1 V	0.35	0.97	101
BPSD00100954121□00	120	10,20	1 kHz, 1 V	0.4	0.89	121
BPSD00100954151□00	150	10,20	1 kHz, 1 V	0.47	0.78	151
BPSD00100954181□00	180	10,20	1 kHz, 1 V	0.63	0.72	181
BPSD00100954221□00	220	10,20	1 kHz, 1 V	0.73	0.66	221
BPSD00100954271□00	270	10,20	1 kHz, 1 V	0.97	0.57	271
BPSD00100954331□00	330	10,20	1 kHz, 1 V	1.15	0.52	331
BPSD00100954391□00	390	10,20	1 kHz, 1 V	1.3	0.48	391
BPSD00100954471□00	470	10,20	1 kHz, 1 V	1.48	0.42	471
BPSD00100954561□00	560	10,20	1 kHz, 1 V	1.9	0.33	561
BPSD00100954681□00	680	10,20	1 kHz, 1 V	2.25	0.28	681
BPSD00100954821□00	820	10,20	1 kHz, 1 V	2.55	0.24	821
BPSD00100954102□00	1000	10,20	1 kHz, 1 V	3.1	0.2	102

Note: When ordering, please specify tolerance code. Tolerance: K=±10% , M=±20%

- Operating temperature range – 40°C ~ 125°C (Including self - temperature rise)
- Isat for Inductance drop 10% from its value without current
- Measure Equipment :
 - L : Agilent/ E4980 or HP4284A (under 1MHz), HP4285A (over 1MHz)
 - SRF : HP4286A
 - RDC : Chroma 16502
 - Isat : HP4284+42841A or WK3260B+WK3265B

Please be sure to request approval specifications that provide further details of the products. Kindly note that the content of these specifications are subject to change or may be discontinued without prior notice. This product may not be designed/used in medical or high risk applications without Chilisin approval. Please contact our sales department before ordering.

Electrical Characteristics

Part Number	Inductance (μ H)	Tolerance (\pm %)	Test Frequency	RDC (Ω)Max	Isat (A)	Marking
BPSD00100965220□00	22	10,20	2.52 MHz,1 V	0.08	3.8	220
BPSD00100965471□00	470	10,20	1 kHz,1 V	1.421	0.82	471
BPSD00100965102□00	1000	10,20	1 kHz,1 V	2.9	0.6	102
BPSD00100965122□00	1200	10,20	1 kHz,1 V	3.5	0.5	122
BPSD00100965152□00	1500	10,20	1 kHz,1 V	3.8	0.6	152
BPSD00100965202□00	2000	10,20	1 kHz,1 V	6.6	0.4	202
BPSD00100965222□00	2200	10,20	1 kHz,1 V	6	0.4	222
BPSD00100965602□00	6000	10,20	1 kHz,1 V	14	0.27	602
BPSD00100965822□00	8200	10,20	1 kHz,1 V	50	0.2	822

Note: When ordering, please specify tolerance code. Tolerance: K= \pm 10% , M= \pm 20%

- Operating temperature range – 40°C ~ 125°C (Including self - temperature rise)
- Isat for Inductance drop 10% from its value without current
- Measure Equipment :
 - L : Agilent/ E4980 or HP4284A (under 1MHz), HP4285A (over 1MHz)
 - SRF : HP4286A
 - RDC : Chroma 16502
 - Isat : HP4284+42841A or WK3260B+WK3265B

SMD Shielded Power Inductors – BPSD Series

Test Instruments : HP4294A Impedance / Material Analyzer

BPSD00050432

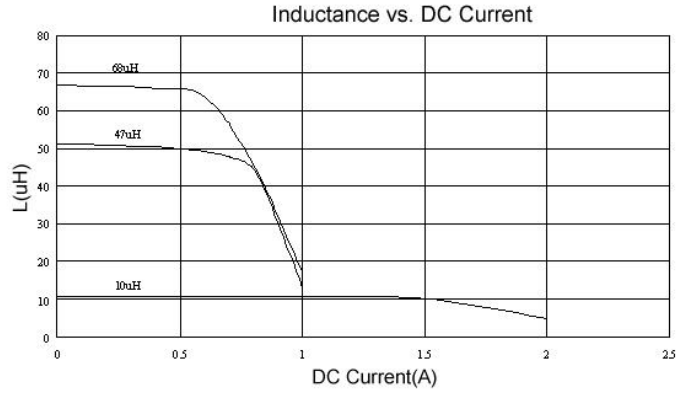
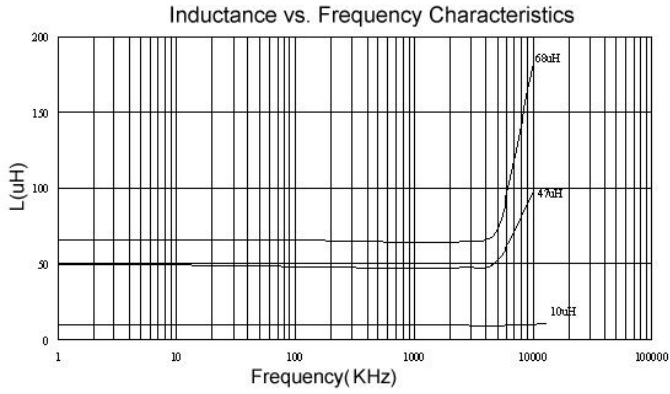

BPSD00060545

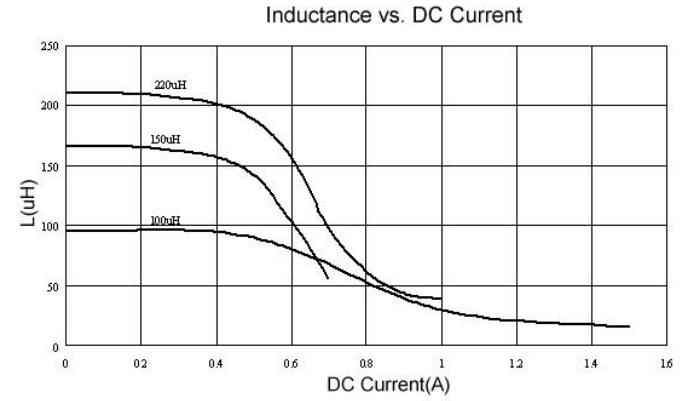
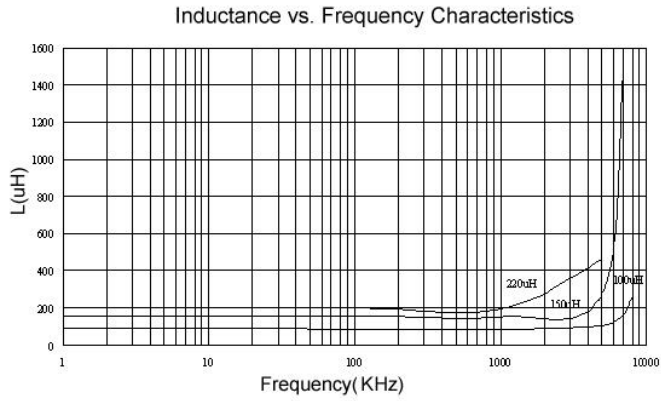

BPSD00080735

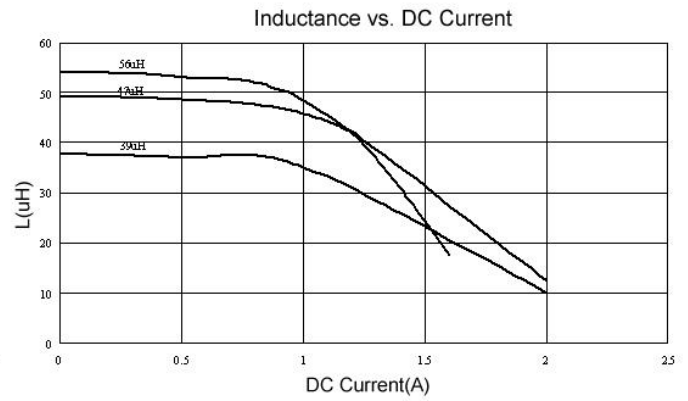
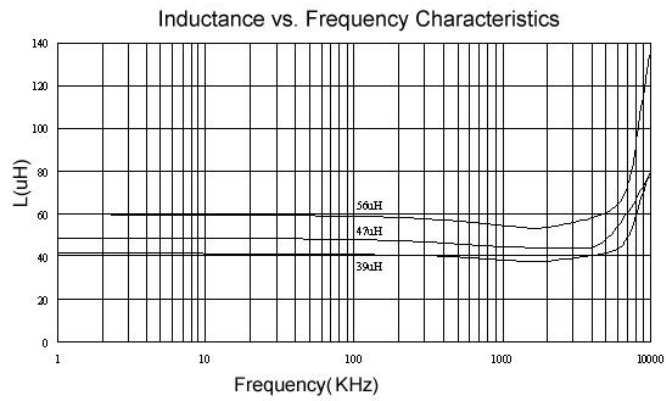

Please be sure to request approval specifications that provide further details of the products. Kindly note that the content of these specifications are subject to change or may be discontinued without prior notice. This product may not be designed/used in medical or high risk applications without Chilisin approval. Please contact our sales department before ordering.

SMD Shielded Power Inductors – BPSD Series

Test Instruments : HP4294A Impedance / Material Analyzer

BPSD00080750

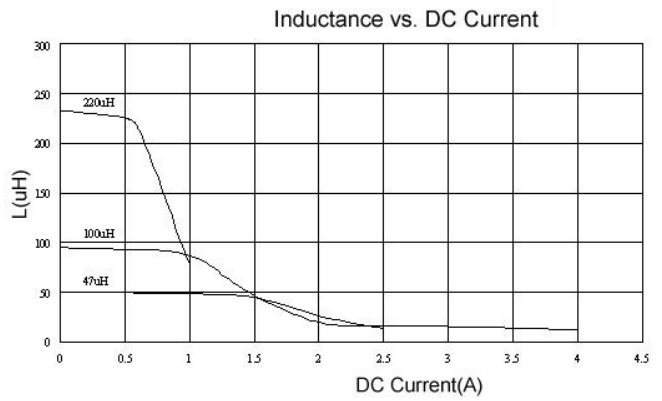
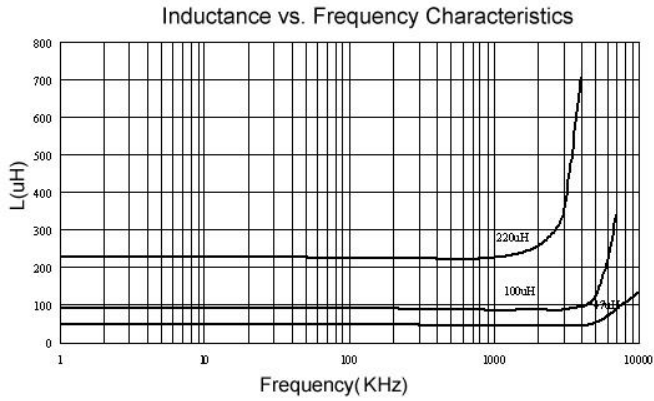

BPSD00100940

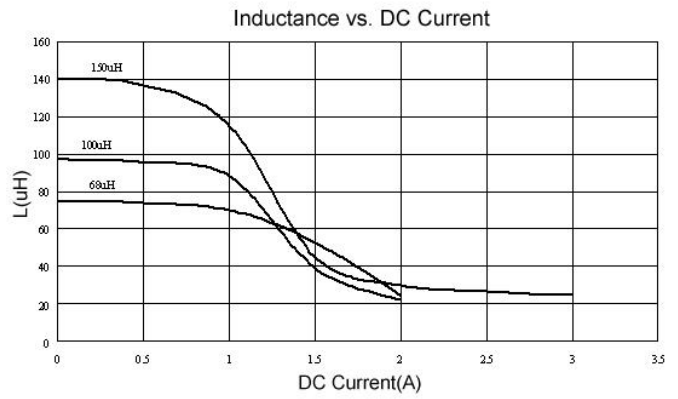
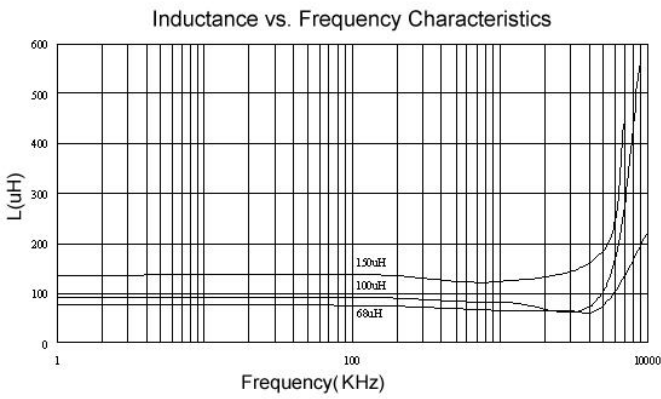

BPSD00100954

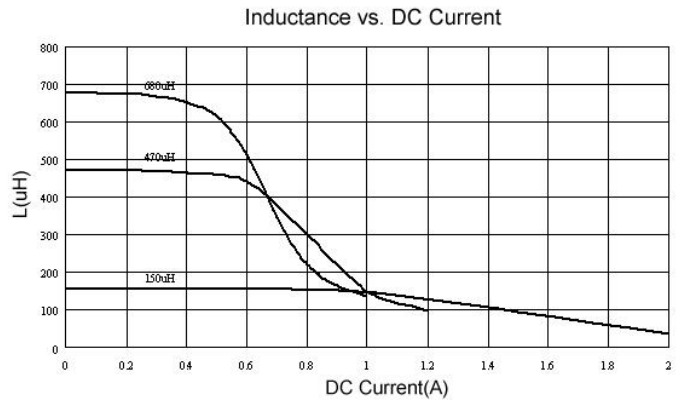
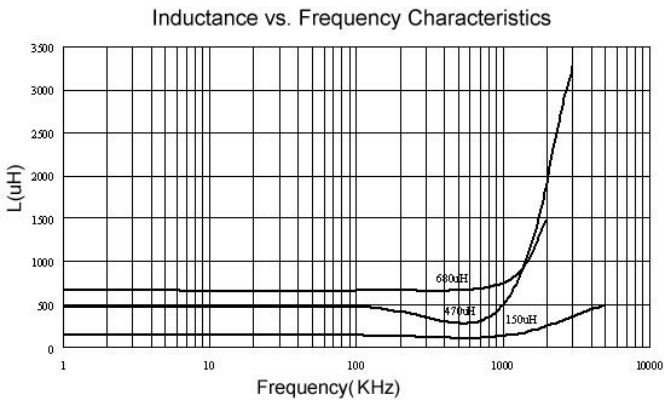

Please be sure to request approval specifications that provide further details of the products. Kindly note that the content of these specifications are subject to change or may be discontinued without prior notice. This product may not be designed/used in medical or high risk applications without Chilisin approval. Please contact our sales department before ordering.

SMD Shielded Power Inductors – BPSD Series

Packaging Specifications

Tape Dimensions

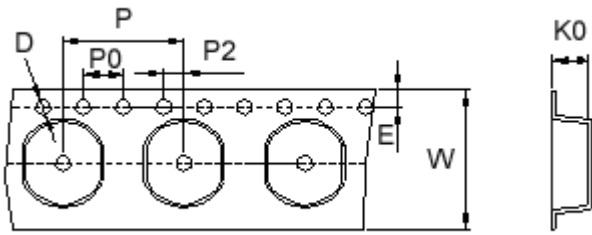

Tape Material

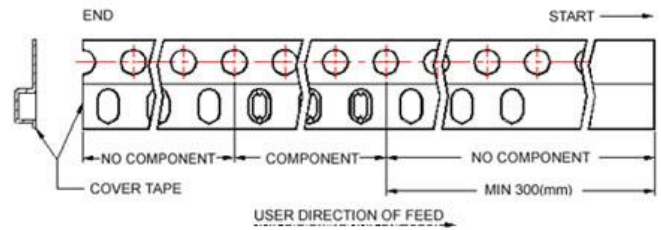

Reel Dimensions

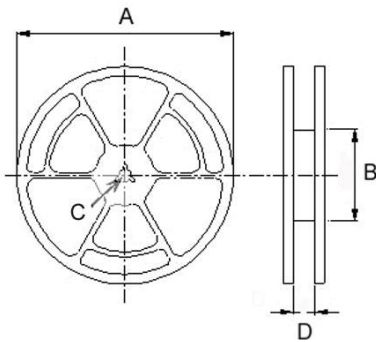

Dimensions in mm

TYPE	Tape Dimensions							Reel Dimensions				Quantity
	K0	D	E	W	P	P0	P2	A	B	C	D	PCS / REEL
BPSD00030315	1.80	1.55	1.75	12	8	4	2	330	100	13	13.4	3000
BPSD00030321	2.50	1.55	1.75	12	8	4	2	330	100	13	13.4	3000
BPSD00050432	3.55	1.55	1.75	12	8	4	2	330	100	13	13.4	2000
BPSD00060525	3.30	1.50	1.75	16	8	4	2	330	100	13	16.0	2000
BPSD00060530	3.30	1.50	1.75	16	8	4	2	330	100	13	16.0	2000
BPSD00060545	4.8	1.55	1.75	16	8	4	2	330	100	13	16.0	1500
BPSD00080735	3.8	1.55	1.75	16	12	4	2	330	100	13	16.0	1000
BPSD00080750	5.2	1.55	1.75	16	12	4	2	330	100	13	16.0	700
BPSD00100940	4.5	1.55	1.75	24	12	4	2	330	100	13	24.4	700
BPSD00100954	5.8	1.55	1.75	24	12	4	2	330	100	13	24.4	700
BPSD00100965	7.0	1.55	1.75	24	12	4	2	330	100	13	24.4	500

单击下面可查看定价，库存，交付和生命周期等信息

[>>CHILISIN\(奇力新\)](#)