

**Leaded Power Chokes AFDI Series**

**Automotive  
AEC-Q200**

RoHS Compliant  
Halogen Free  
REACH Compliant



- Power Circuit
- Shield
- Wire Wound
- Metal
- Ultra High Current

**Part Numbering**

A	FDI	00	303012	1R0	M	01
Grade	Series Name	Control Code	Dimensions Code (mm)	Inductance (uH)	Tolerance	Internal Code
			111109 12x12x9~9.5	1R0 1.0	M ±20%	R1
			121210 12x12x10	100 10		04
			131210 13x12x8~12	101 100		06
			161311 15.5x13x10~12			
			191909 19.5x8.5			
			212010 20.5x9.5			
			282811 28x10.5			
			303012 30x12.7			

**Leaded Power Chokes AFDI Series**

**Automotive  
AEC-Q200**

**AFDI00111109 Type**

**■ Dimensions**

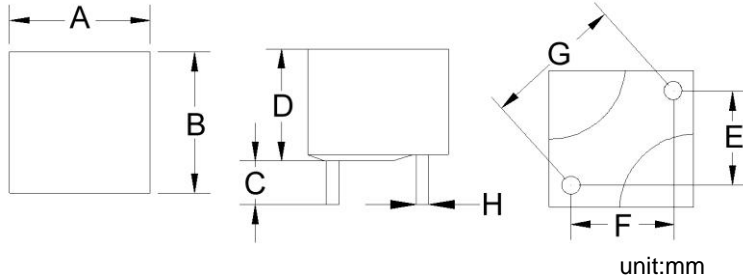

**■ Recommended Land Pattern**

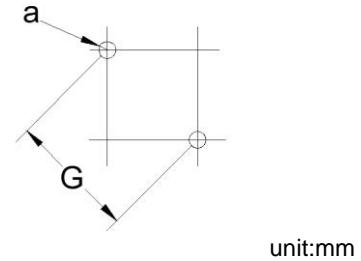

**■ Electrical Characteristics**

Part No.	L (uH)	Test Freq.	RDC(mΩ) Typ(Max)	Isat (A)Typ.	Irms (A)Typ.	Tol. (±%)	Dimensions								
							A Max	B Max	C±0.5	D Max	E±0.5	F±0.5	G±0.5	H±0.1	a
AFDI001111091R0MR1	1	100kHz,1V	0.62(1.5)	35	35	20	12	12	3.4	9	7.3	6	9.4	1.5	1.9
AFDI001111092R5MR1	2.5	100kHz,1V	2.37(2.6)	25	27	20	12	12	3.4	9.5	6.6	6.6	9.3	1.2	1.6

**Note: When ordering, please specify tolerance code. Tolerance: M=±20%**

1. Customized Specifications are welcome
2. Operating temperature range - 50°C ~ 155°C(Including self - temperature rise)
3. Isat for Inductance drop 20% from its value without current
4. Irms for a 40°C temprature rise from 25°C ambient with current
5. Measure Equipment:  
L: WK4237  
RDC: CHEN HWA502  
Isat: WK3260B/ 3265  
Irms: WK3260B/ 3265

Leaded Power Chokes AFDI Series

Automotive  
AEC-Q200

AFDI00111109 Type

Characteristics Graph

Inductance vs. DC Current

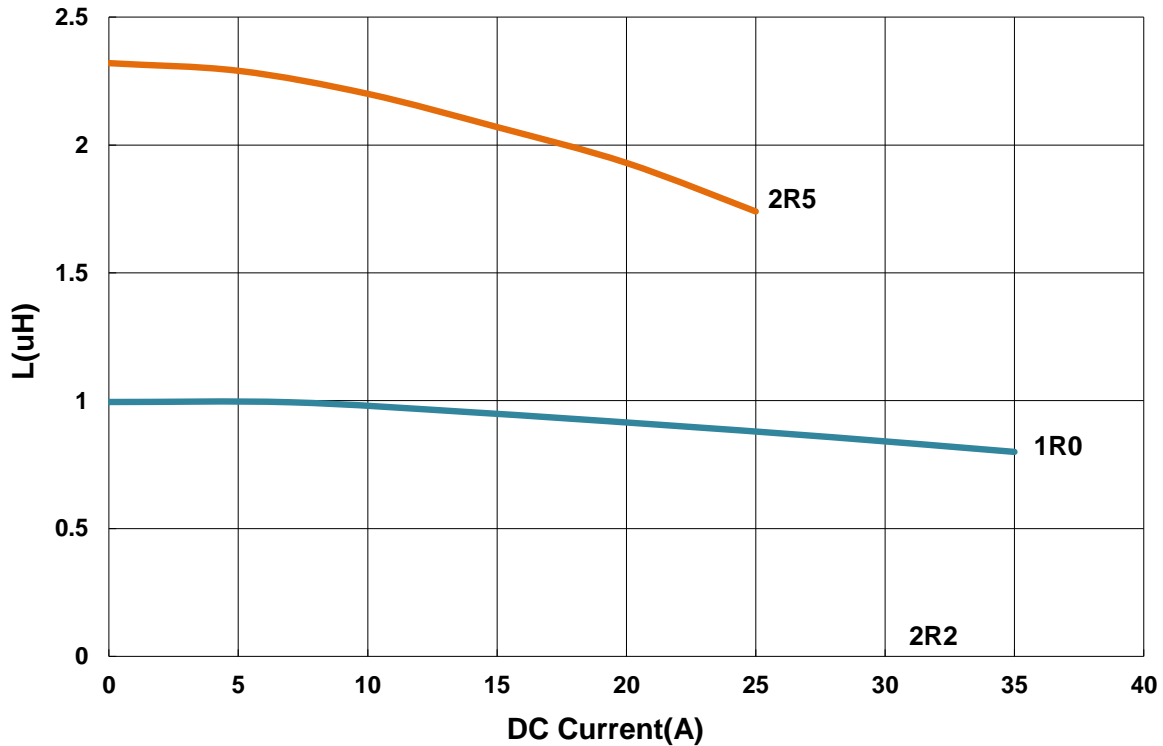

Temperature Change vs. DC Current

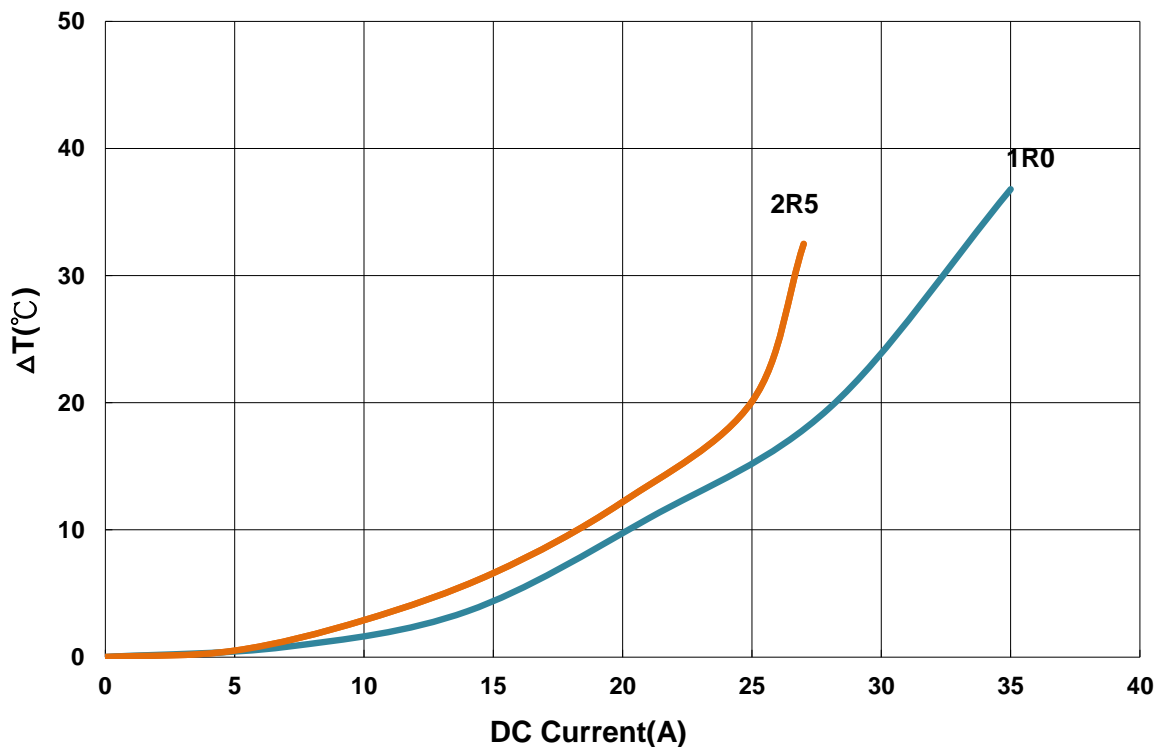

**Leaded Power Chokes AFDI Series**

**Automotive  
AEC-Q200**

**AFDI00121210 Type**

**■ Dimensions**

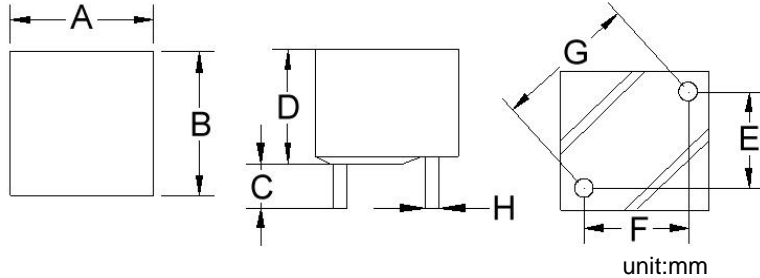

**■ Recommended Land Pattern**

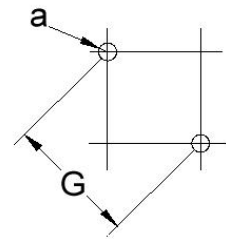

unit:mm

**■ Electrical Characteristics**

Part No.	L (uH)	Test Freq.	RDC(mΩ) Typ(Max)	Isat (A)Typ.	Irms (A)Typ.	Tol. (±%)	Dimensions								
							A±0.5	B±0.5	C±0.5	D Max	E±0.5	F±0.5	G±0.5	H±0.1	a
AFDI001212104R7M01	4.7	100kHz,1V	4.51(6)	16	15	20	12Max	12Max	3.4	10	7	7	10	1.1	1.5
AFDI001212108R2M01	8.2	100kHz,1V	7.92(9.3)	8	11	20	12	12	3.4	10	7	7	10	1	1.4

**Note: When ordering, please specify tolerance code. Tolerance: M=±20%**

1. Customized Specifications are welcome
2. Operating temperature range - 50°C ~ 155°C(Including self - temperature rise)
3. Isat for Inductance drop 20% from its value without current
4. Irms for a 40°C temperature rise from 25°C ambient with current
5. Measure Equipment:  
L: WK4237  
RDC: CHEN HWA502  
Isat: WK3260B/ 3265  
Irms: WK3260B/ 3265

Leaded Power Chokes AFDI Series

Automotive  
AEC-Q200

AFDI00121210 Type

■ Characteristics Graph

Inductance vs. DC Current

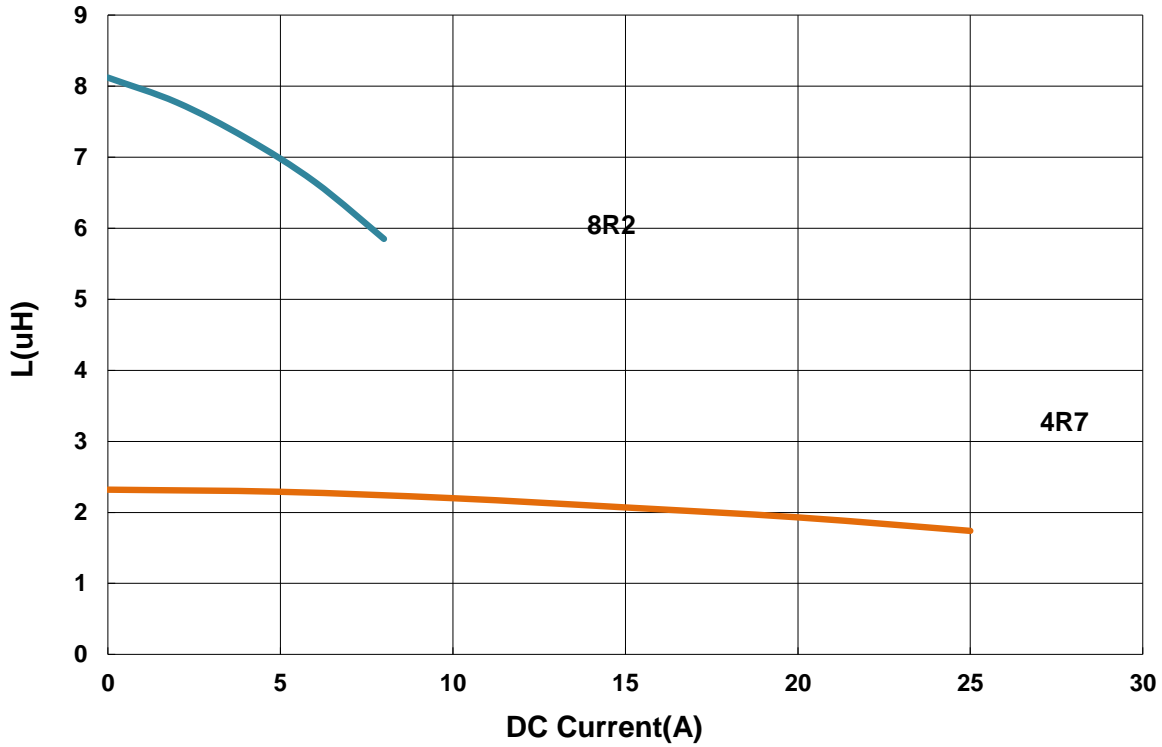

Temperature Change vs. DC Current

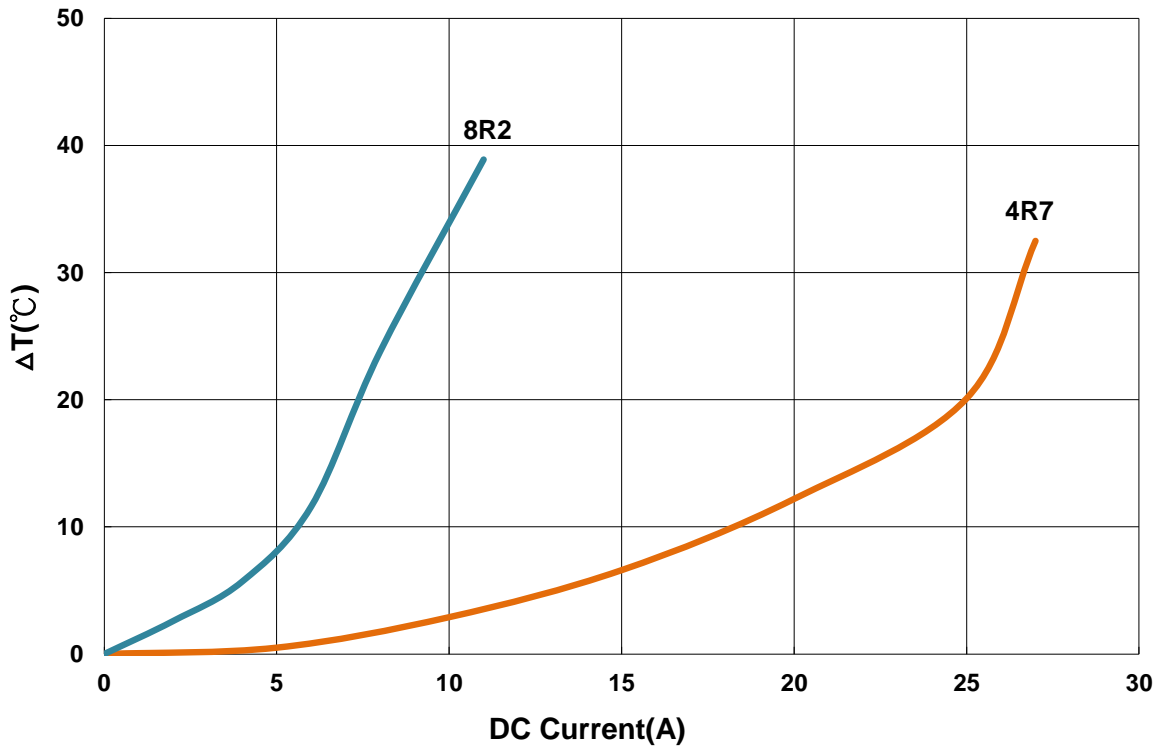

**Leaded Power Chokes AFDI Series**

**Automotive  
AEC-Q200**

**AFDI00131210 Type**

**Dimensions**

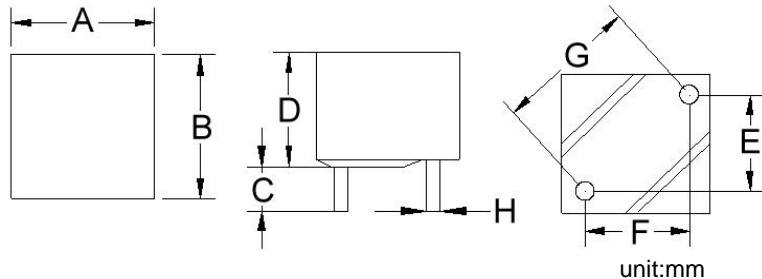

**Recommended Land Pattern**

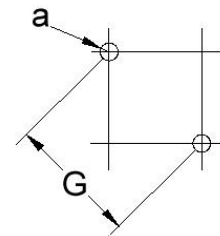

unit:mm

**Electrical Characteristics**

Part No.	L (uH)	Test Freq.	RDC(mΩ) Typ(Max)	Isat (A)Typ.	Irms (A)Typ.	Tol. (±%)	Dimensions								
							A±0.5	B±0.5	C±0.5	D Max	E±0.5	F±0.5	G±0.5	H±0.1	a
AFDI00131210R22M01	0.2	100kHz,1V	0.45(0.6)	55	60	20	12	13	3.5	8	7.5	6.5	10	1.5±0.2	1.9
AFDI00131210R60M01	0.6	100kHz,1V	0.88(1)	45	35	20	13	12	3.4	10	6.6	7.6	10	1.5	1.9
AFDI00131210R68M01	0.68	100kHz,1V	0.83(0.88)	50	45	30	12	13	3.5	8	7.6	6.5	10	1.5±0.2	1.9
AFDI001312101R0M01	1	100kHz,1V	1.12(1.32)	40	30	20	13	12	3.4	10	6.6	7.6	10	1.5	1.9
AFDI001312101R5M01	1.5	100kHz,1V	1.81(2)	40	26	20	13	12	3.4	11	6.6	7.6	10	1.2	1.6
AFDI001312102R2M01	2.2	100kHz,1V	1.85(2)	20	20	20	13	12	3.4	10.5	6.6	7.6	10	1.3	1.7
AFDI001312102R5M01	2.5	100kHz,1V	2.44(2.8)	34	28	20	13	12	3.4	10.5	6.6	7.6	10	1.2	1.6
AFDI001312103R3M01	3.3	100kHz,1V	2.55(4)	23	19	20	13	12	3.4	12	6.6	7.6	10	1.2	1.6
AFDI001312104R7M01	4.7	100kHz,1V	4.28(6)	20	20	20	13	12	3.4	12	6.6	7.6	10	1.3	1.7

**Note: When ordering, please specify tolerance code. Tolerance: M=±20%**

1. Customized Specifications are welcome
2. Operating temperature range - 50°C ~ 155°C(Including self - temperature rise)
3. Isat for Inductance drop 20% from its value without current
4. Irms for a 40°C temprature rise from 25°C ambient with current
5. Measure Equipment:  
 L: WK4237  
 RDC: CHEN HWA502  
 Isat: WK3260B/ 3265  
 Irms: WK3260B/ 3265

**Leaded Power Chokes AFDI Series**

**Automotive  
AEC-Q200**

**AFDI00131210 Type**

**Characteristics Graph**

**Inductance vs. DC Current**

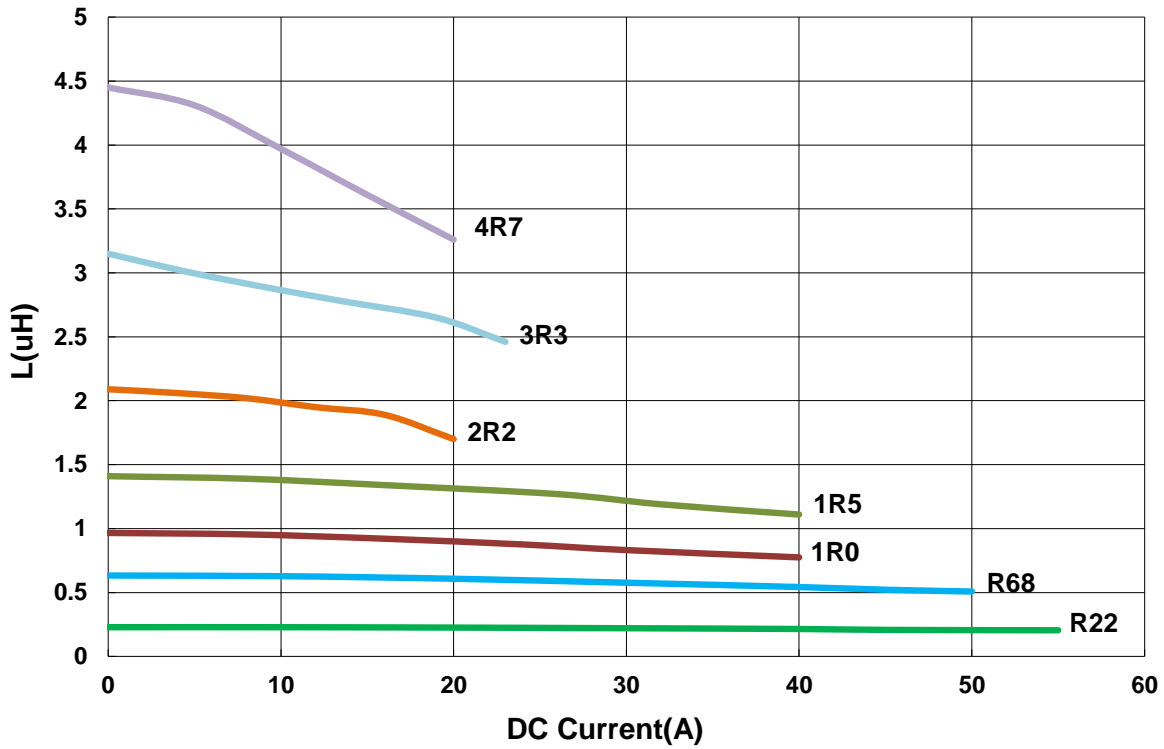

**Inductance vs. DC Current**

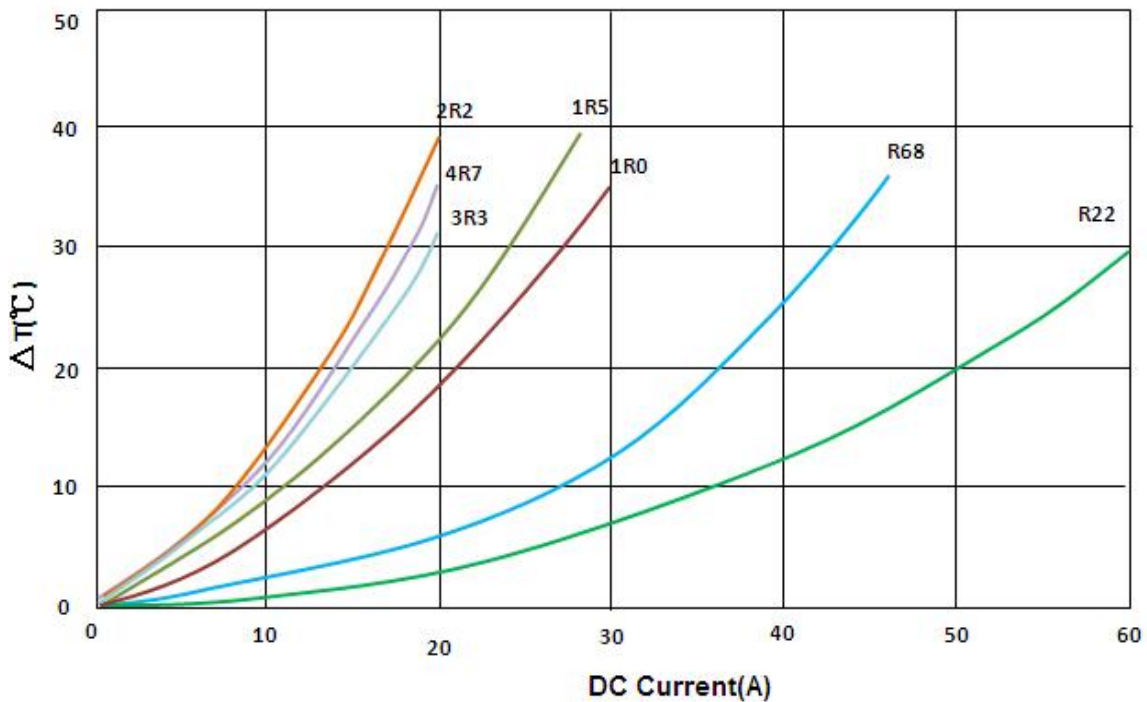

**Leaded Power Chokes AFDI Series**

**Automotive  
AEC-Q200**

**AFDI00161311 Type**

**Dimensions**

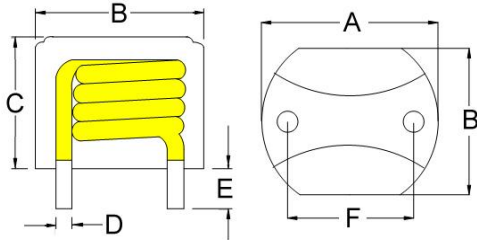

unit:mm

**Recommended Land Pattern**

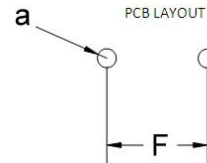

unit:mm

**Electrical Characteristics**

Part No.	L (uH)	Test Freq.	RDC(mΩ) Typ(Max)	Isat (A)Typ.	Irms (A)Typ.	Tol. (±%)	Dimensions						
							A±0.5	B±0.5	C Max	D±0.1	E±0.5	F±0.5	a
AFDI001613113R3M01	3.3	100kHz,1V	3.18(3.7)	35	25	20	15.5	13	11	1.2	3.4	10	1.6
AFDI001613116R4M01	6.4	100kHz,1V	5.6(6.5)	20	14	20	15.5	13	12	1.2	4	10	1.6
AFDI001613116R8M01	6.8	100kHz,1V	5.83(6.5)	20	14	20	15.5	13	12	1.2	4	10	1.6
AFDI00161311120M01	12	100kHz,1V	10.02(12)	15	12	20	15.5	13	10	0.9	4	10	1.3
AFDI00161311220M01	22	100kHz,1V	16.97(25)	9	9	20	15.5	13	10.4±0.4	0.8	4	10	1.2

**Note: When ordering, please specify tolerance code. Tolerance: M=±20%**

1. Customized Specifications are welcome
2. Operating temperature range - 50°C ~ 155°C(Including self - temperature rise)
3. Isat for Inductance drop 20% from its value without current
4. Irms for a 40°C temperature rise from 25°C ambient with current
5. Measure Equipment:

L: WK4237  
 RDC: CHEN HWA502  
 Isat: WK3260B/ 3265  
 Irms: WK3260B/ 3265



**Leaded Power Chokes AFDI Series**

**Automotive  
AEC-Q200**

**AFDI00161311 Type**

**Characteristics Graph**

**Inductance vs. DC Current**

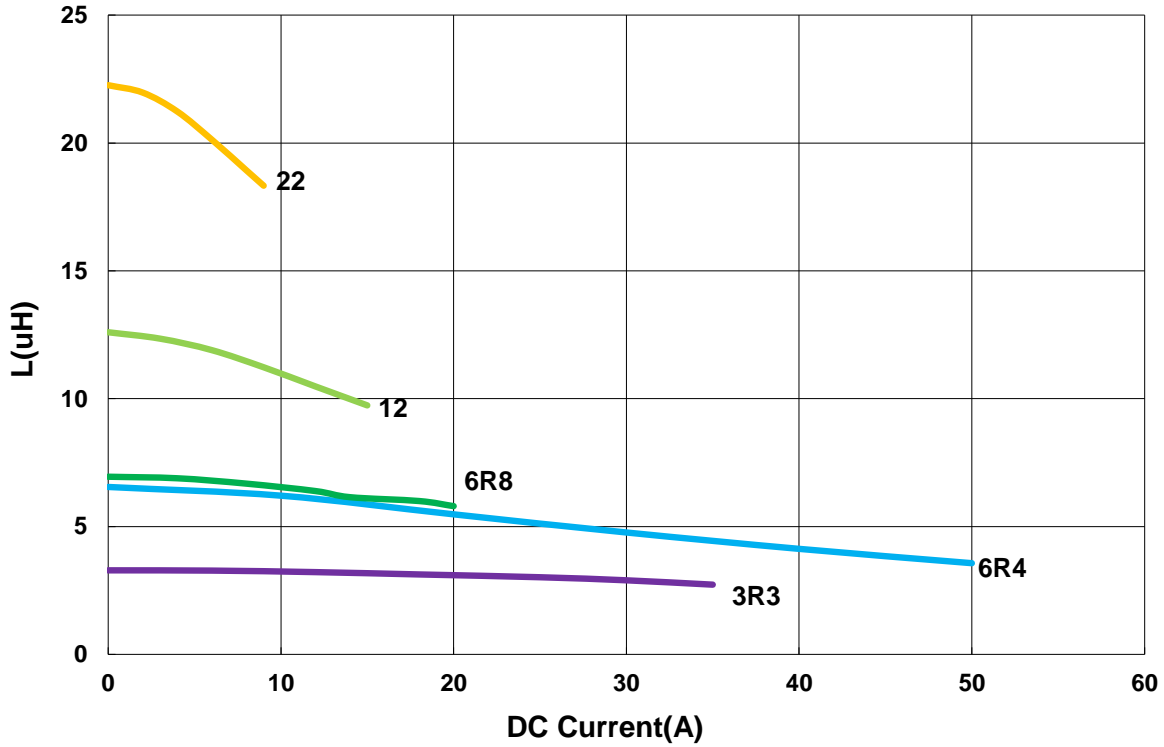

**Temperature Change vs. DC Current**

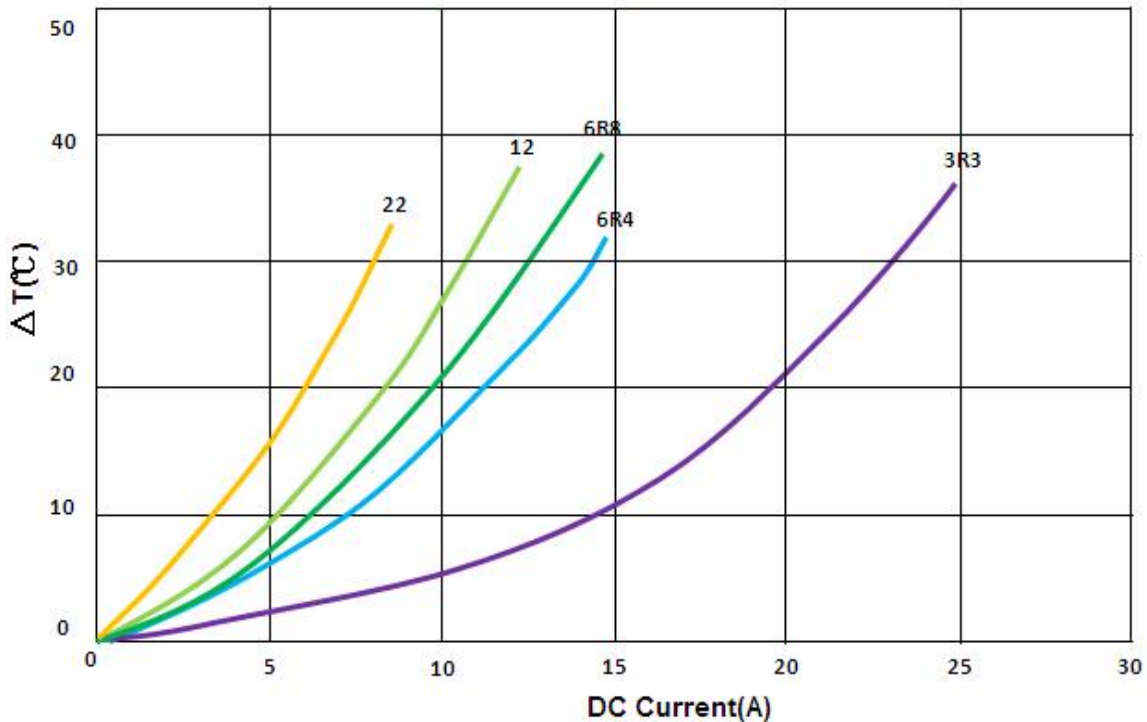

**Leaded Power Chokes AFDI Series**

**Automotive  
AEC-Q200**

**AFDI00191909 Type**

**Dimensions**

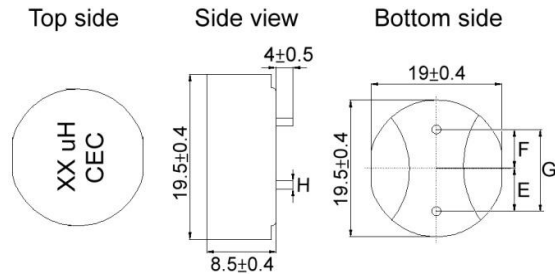

0.47uH~10uH

**Recommended Land Pattern**

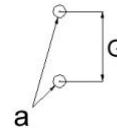

unit:mm

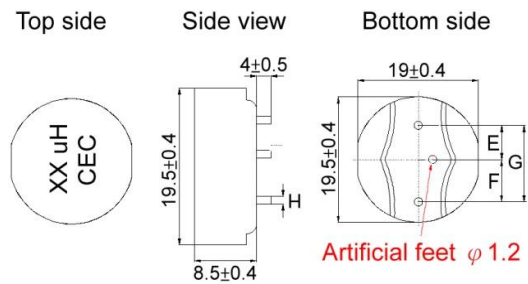

22uH~100uH

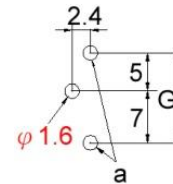

unit:mm

**Electrical Characteristics**

Part No.	L (uH)	Test Freq.	RDC(mΩ) Max(Typ)	Isat (A)Typ.	Irms (A)Typ.	Tol. (±%)	Marking	Dimensions				
								E	F	G	H	a
AFDI00191909R47M06	0.47	100kHz,1V	0.45(0.33)	75	80	20	0.47 uH	6±0.5	6±0.5	12±0.5	2.0±0.1	2.4
AFDI001919091R0M06	1	100kHz,1V	0.86(0.75)	44	54	20	1.0 uH	6±0.5	6±0.5	12±0.5	1.8±0.1	2.2
AFDI001919092R2M06	2.2	100kHz,1V	1.52(1.32)	38	45	20	2.2 uH	6±0.5	6±0.5	12±0.5	1.8±0.1	2.2
AFDI001919093R3M06	3.3	100kHz,1V	2.3(1.95)	33	39	20	3.3 uH	5.5±0.5	6.5±0.5	12±0.5	1.6±0.1	2
AFDI001919094R7M06	4.7	100kHz,1V	3.2(2.91)	27	31	20	4.7 uH	5±0.5	7±0.5	12±0.5	1.4±0.1	1.8
AFDI001919096R8M06	6.8	100kHz,1V	4.1(3.85)	22	30	20	6.8 uH	5±0.5	7±0.5	12±0.5	1.4±0.1	1.8
AFDI001919098R2M06	8.2	100kHz,1V	6(4.85)	20	24	20	8.2 uH	5±0.5	7±0.5	12±0.5	1.3±0.1	1.7
AFDI00191909100M06	10	100kHz,1V	7(5.85)	18	22	20	10 uH	5±0.5	7±0.5	12±0.5	1.3±0.1	1.7
AFDI00191909220M06	22	100kHz,1V	13(12.06)	13	15	20	22 uH	5±0.5	7±0.5	12±0.5	1.0±0.1	1.4
AFDI00191909330M06	33	100kHz,1V	22.8(20.78)	11	10	20	33 uH	5±0.5	7±0.5	12±0.5	0.9±0.1	1.3
AFDI00191909470M06	47	100kHz,1V	35.2(32)	8	8	20	47 uH	5±0.5	7±0.5	12±0.5	0.8±0.1	1.2
AFDI00191909680M06	68	100kHz,1V	46(40.5)	7	7.5	20	68 uH	5±0.5	7±0.5	12±0.5	0.8±0.1	1.2
AFDI00191909820M06	82	100kHz,1V	56(50.2)	7	6	20	82 uH	5±0.5	7±0.5	12±0.5	0.7±0.1	1.1
AFDI00191909101M06	100	100kHz,1V	62(56.5)	6	6	20	100 uH	5±0.5	7±0.5	12±0.5	0.7±0.1	1.1

**Note: When ordering, please specify tolerance code. Tolerance: M=±20%**

1. Customized Specifications are welcome
2. Operating temperature range - 50°C ~ 155°C(Including self - temperature rise)
3. Isat for Inductance drop 20% from its value without current
4. Irms for a 40°C temperature rise from 25°C ambient with current
5. Measure Equipment:

L: WK4237  
RDC: CHEN HWA502  
Isat: WK3260B/ 3265  
Irms: WK3260B/ 3265

**Leaded Power Chokes AFDI Series**

**Automotive  
AEC-Q200**

**AFDI00191909 Type**

**Characteristics Graph**

**Inductance vs. DC Current**

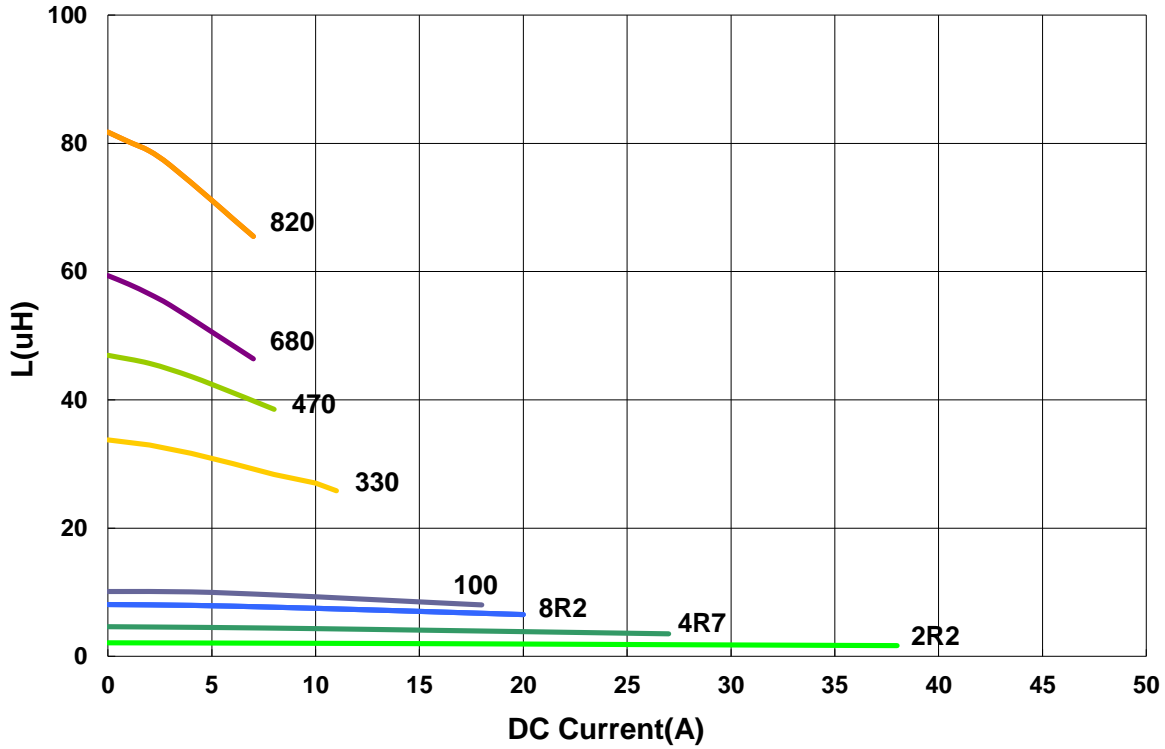

**Temperature Change vs. DC Current**

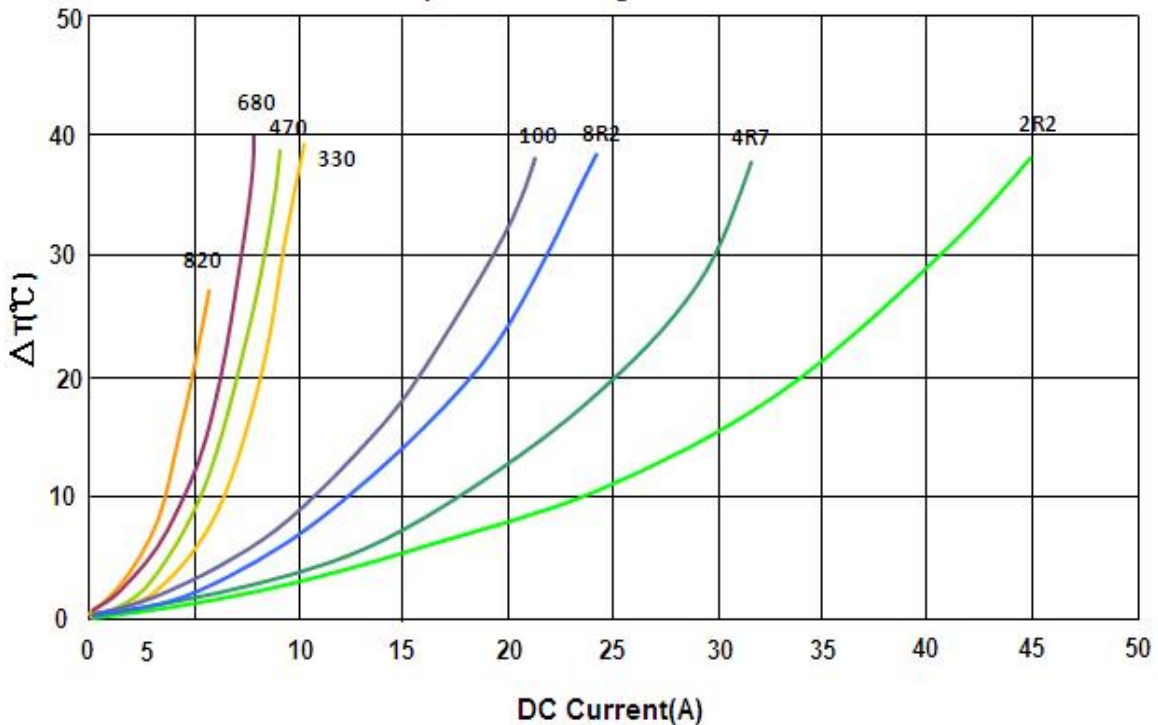

Please be sure to request approval specifications that provide further details of the products. Kindly note that the content of these specifications are subject to change or may be discontinued without prior notice. This product may not be designed/used in medical or high risk applications without Chilisin approval. Please contact our sales department before ordering.

**Leaded Power Chokes AFDI Series**

**Automotive  
AEC-Q200**

**AFDI00212010 Type**

**■ Dimensions**

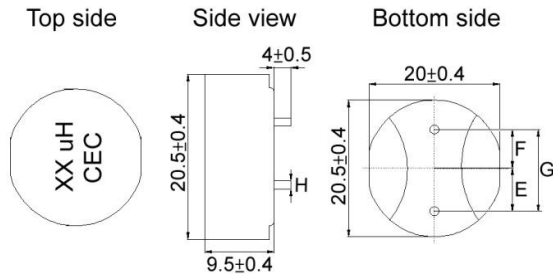

0.47uH~10uH

**■ Recommended Land Pattern**

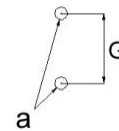

unit:mm

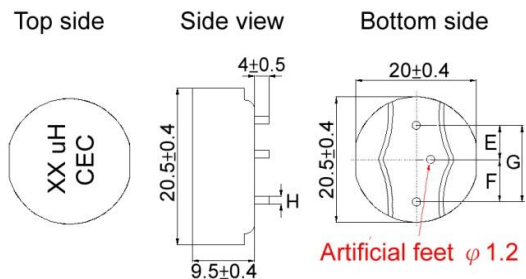

22uH~100uH

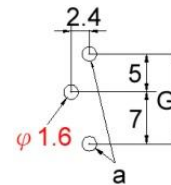

unit:mm

**■ Electrical Characteristics**

Part No.	L (uH)	Test Freq.	RDC(mΩ) Max(Typ)	Isat (A)Typ.	Irms (A)Typ.	Tol. (±%)	Marking	Dimensions				
								E	F	G	H	a
AFDI00212010R47M01	0.47	100kHz,1V	0.44(0.31)	65	65	20	0.47 uH	6±0.5	6±0.5	12±0.5	2.0±0.1	2.4
AFDI002120101R0M01	1.0	100kHz,1V	0.88(0.7)	60	62	20	1.0 uH	6±0.5	6±0.5	12±0.5	1.8±0.1	2.2
AFDI002120102R2M01	2.2	100kHz,1V	1.58(1.24)	40	46	20	2.2 uH	6±0.5	6±0.5	12±0.5	1.8±0.1	2.2
AFDI002120103R3M01	3.3	100kHz,1V	2.3(1.81)	34	35	20	3.3 uH	5.5±0.5	6.5±0.5	12±0.5	1.6±0.1	2
AFDI002120104R7M01	4.7	100kHz,1V	2.98(2.59)	30	27	20	4.7 uH	5±0.5	7±0.5	12±0.5	1.4±0.1	1.8
AFDI002120106R8M01	6.8	100kHz,1V	4.12(3.72)	28	25	20	6.8 uH	5±0.5	7±0.5	12±0.5	1.4±0.1	1.8
AFDI002120108R2M01	8.2	100kHz,1V	5.8(4.53)	26	21	20	8.2 uH	5±0.5	7±0.5	12±0.5	1.3±0.1	1.7
AFDI00212010100M01	10	100kHz,1V	7(5.57)	25	20	20	10 uH	5±0.5	7±0.5	12±0.5	1.3±0.1	1.7
AFDI00212010220M01	22	100kHz,1V	13.1(12.6)	16	13	20	22 uH	5±0.5	7±0.5	12±0.5	1.0±0.1	1.4
AFDI00212010330M01	33	100kHz,1V	22(18.9)	12	10	20	33 uH	5±0.5	7±0.5	12±0.5	0.9±0.1	1.3
AFDI00212010470M01	47	100kHz,1V	35.6(30.65)	10	8	20	47 uH	5±0.5	7±0.5	12±0.5	0.8±0.1	1.2
AFDI00212010680M01	68	100kHz,1V	44.8(38)	11	7	20	68 uH	5±0.5	7±0.5	12±0.5	0.8±0.1	1.2
AFDI00212010820M01	82	100kHz,1V	55.8(48.86)	9	6.4	20	82 uH	5±0.5	7±0.5	12±0.5	0.7±0.1	1.1
AFDI00212010101M01	100	100kHz,1V	62(54.51)	9	5.8	20	100 uH	5±0.5	7±0.5	12±0.5	0.7±0.1	1.1

**Note: When ordering, please specify tolerance code. Tolerance: M=±20%**

1. Customized Specifications are welcome
2. Operating temperature range - 50°C ~ 155°C(Including self - temperature rise)
3. Isat for Inductance drop 20% from its value without current
4. Irms for a 40°C temperature rise from 25°C ambient with current
5. Measure Equipment:

L: WK4237  
RDC: CHEN HWA502  
Isat: WK3260B/ 3265  
Irms: WK3260B/ 3265

**Leaded Power Chokes AFDI Series**

**Automotive  
AEC-Q200**

**AFDI00212010 Type**

**Characteristics Graph**

**Inductance vs. DC Current**

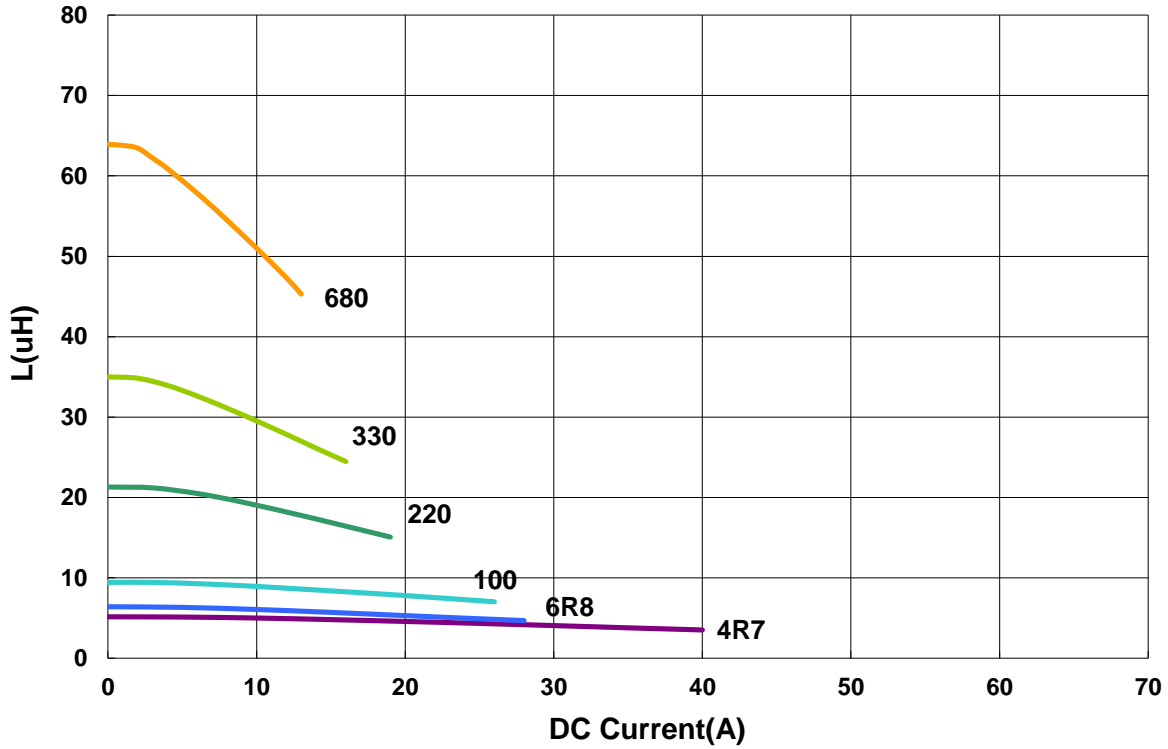

**Temperature Change vs. DC Current**

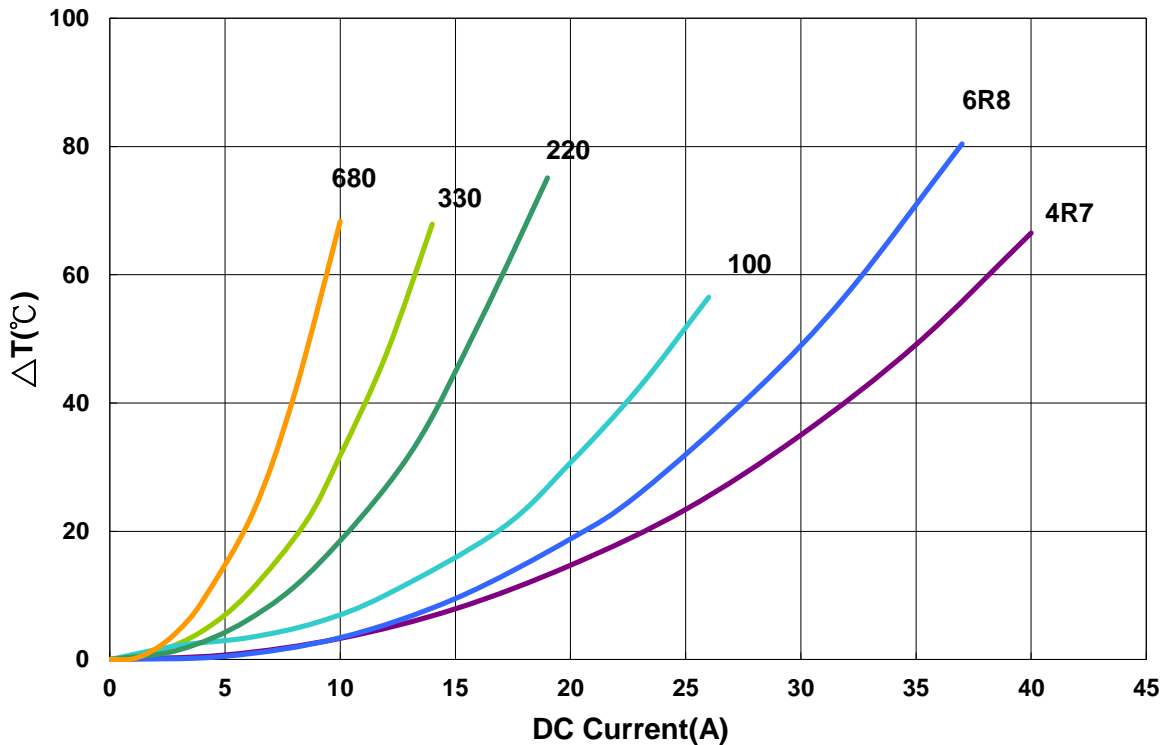

Please be sure to request approval specifications that provide further details of the products. Kindly note that the content of these specifications are subject to change or may be discontinued without prior notice. This product may not be designed/used in medical or high risk applications without Chilisin approval. Please contact our sales department before ordering.

**Leaded Power Chokes AFDI Series**

**Automotive  
AEC-Q200**

**AFDI00282811 Type**

**■ Dimensions**

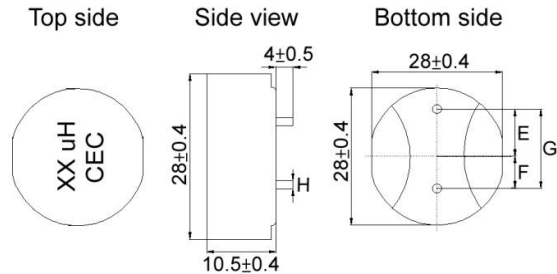

1.0uH~47uH

**■ Recommended Land Pattern**

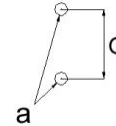

unit:mm

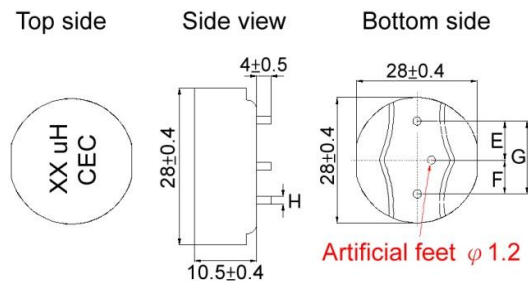

68uH~100uH

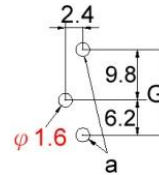

unit:mm

**■ Electrical Characteristics**

Part No.	L (uH)	Test Freq.	RDC(mΩ) Max(Typ)	Isat (A)Typ.	Irms (A)Typ.	Tol. (±%)	Marking	Dimensions				
								E	F	G	H	a
AFDI002828111R0M06	1.0	100kHz,1V	0.49(0.4)	70	90	20	1.0 uH	9.3±0.5	6.7±0.5	16±0.5	2.5±0.1	2.9
AFDI002828112R2M06	2.2	100kHz,1V	0.77(0.72)	64	72	20	2.2 uH	9.3±0.5	6.7±0.5	16±0.5	2.5±0.1	2.9
AFDI002828113R3M06	3.3	100kHz,1V	1.3(1.14)	60	57	20	3.3 uH	9.3±0.5	6.7±0.5	16±0.5	2.3±0.1	2.7
AFDI002828114R7M06	4.7	100kHz,1V	1.43(1.36)	52	53	20	4.7 uH	9.3±0.5	6.7±0.5	16±0.5	2.3±0.1	2.7
AFDI002828116R8M06	6.8	100kHz,1V	1.99(1.91)	44	45	20	6.8 uH	9.3±0.5	6.7±0.5	16±0.5	2.0±0.1	2.4
AFDI002828118R2M06	8.2	100kHz,1V	2.8(2.28)	32	40	20	8.2 uH	8±0.5	8±0.5	16±0.5	2.0±0.1	2.4
AFDI00282811100M06	10	100kHz,1V	3.64(3.13)	30	36	20	10 uH	8±0.5	8±0.5	16±0.5	1.8±0.1	2.2
AFDI00282811150M06	15	100kHz,1V	4.76(4.43)	20	28	20	15 uH	10±0.5	6±0.5	16±0.5	1.8±0.2	2.2
AFDI00282811220M06	22	100kHz,1V	6.85(6.47)	19	24	20	22 uH	9.8±0.5	6.2±0.5	16±0.5	1.6±0.1	2.0
AFDI00282811330M06	33	100kHz,1V	11.3(10.51)	18	18	20	33 uH	10±0.5	6±0.5	16±0.5	1.3±0.1	1.7
AFDI00282811470M06	47	100kHz,1V	14.7(13.69)	16.2	16	20	47 uH	10±0.5	6±0.5	16±0.5	1.3±0.1	1.7
AFDI00282811680M06	68	100kHz,1V	27.4(25.73)	11	11	20	68 uH	9.8±0.5	6.2±0.5	16±0.5	1.1±0.1	1.5
AFDI00282811820M06	82	100kHz,1V	30.5(29.3)	8	11	20	82 uH	9.8±0.5	6.2±0.5	16±0.5	1.1±0.1	1.5
AFDI00282811101M06	100	100kHz,1V	32.2(30.61)	7	11	20	100 uH	9.8±0.5	6.2±0.5	16±0.5	1.1±0.1	1.5

**Note: When ordering, please specify tolerance code. Tolerance: M=±20%**

1. Customized Specifications are welcome
2. Operating temperature range - 50°C ~ 155°C(Including self - temperature rise)
3. Isat for Inductance drop 20% from its value without current
4. Irms for a 40°C temperature rise from 25°C ambient with current
5. Measure Equipment:

L: WK4237  
RDC: CHEN HWA502  
Isat: WK3260B/ 3265  
Irms: WK3260B/ 3265

**Leaded Power Chokes AFDI Series**

**Automotive  
AEC-Q200**

**AFDI00282811 Type**

**Characteristics Graph**

**Inductance vs. DC Current**

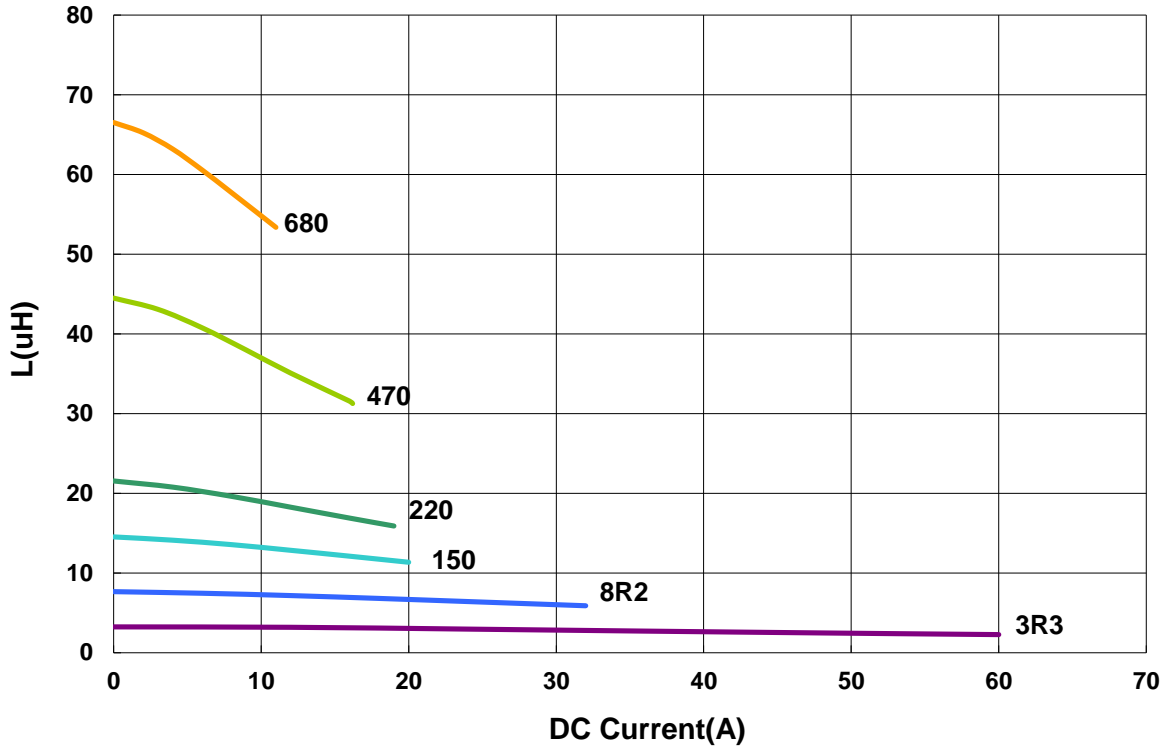

**Temperature Change vs. DC Current**

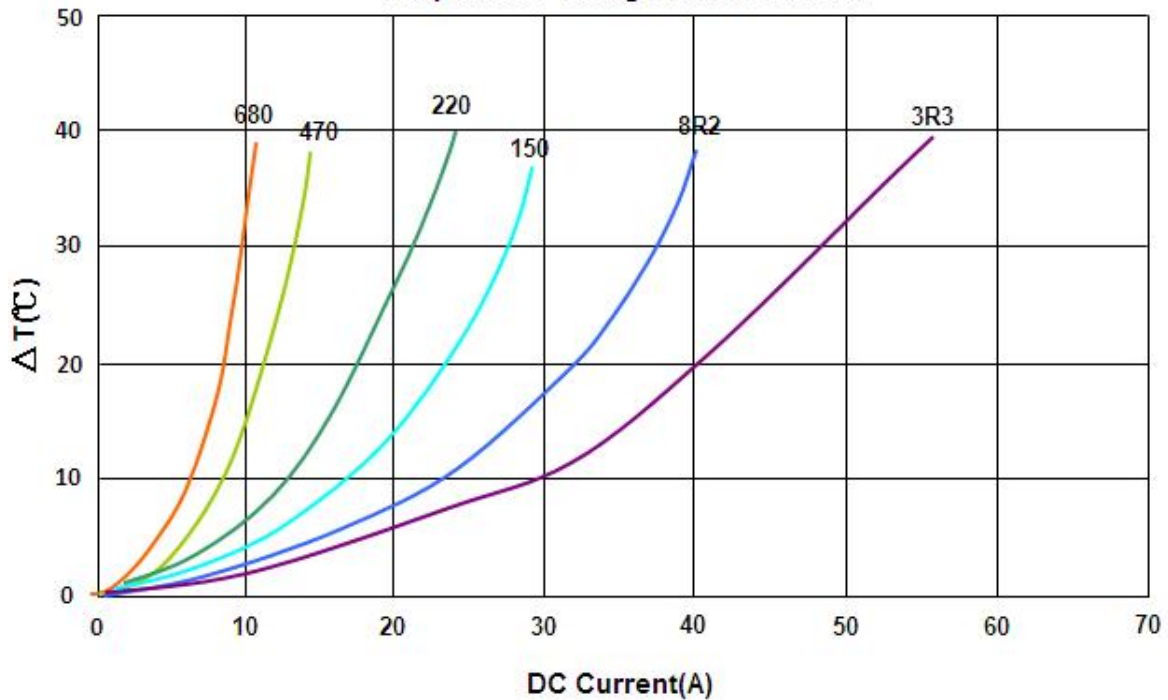

**Leaded Power Chokes AFDI Series**

**Automotive  
AEC-Q200**

**AFDI00303012 Type**

**Dimensions**

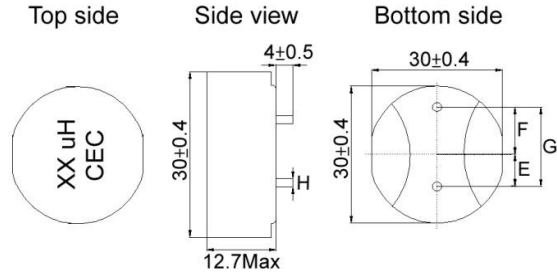

1.0uH~47uH

**Recommended Land Pattern**

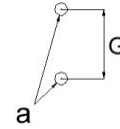

unit:mm

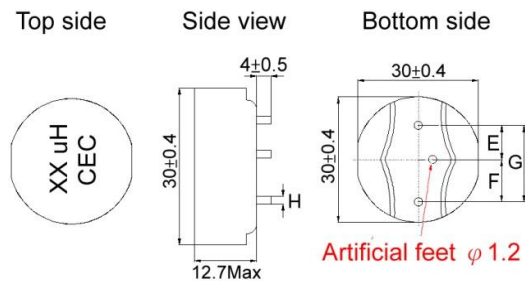

68uH~120uH

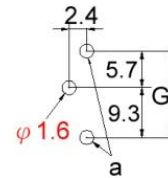

unit:mm

**Electrical Characteristics**

Part No.	L (uH)	Test Freq.	RDC(mΩ) Max(Typ)	Isat (A)Typ.	Irms (A)Typ.	Tol. (±%)	Marking	Dimensions				
								E	F	G	H	a
AFDI003030121R0M04	1.0	100kHz,1V	0.48(0.38)	65	90	20	1.0 uH	6.8±0.5	9.2±0.5	16±0.5	2.5±0.1	2.9
AFDI003030122R2M04	2.2	100kHz,1V	0.77(0.72)	65	72	20	2.2 uH	6.8±0.5	9.2±0.5	16±0.5	2.5±0.1	2.9
AFDI003030123R3M04	3.3	100kHz,1V	1.48(1.31)	62	60	20	3.3 uH	6.2±0.5	9.8±0.5	16±0.5	2.0±0.1	2.4
AFDI003030124R7M04	4.7	100kHz,1V	1.4(1.31)	53	54	20	4.7 uH	6.8±0.5	9.2±0.5	16±0.5	2.3±0.1	2.7
AFDI003030126R8M04	6.8	100kHz,1V	1.9(1.81)	44	45	20	6.8 uH	6.8±0.5	9.2±0.5	16±0.5	2.3±0.1	2.7
AFDI003030128R2M04	8.2	100kHz,1V	2.9(2.56)	34	37	20	8.2 uH	6.2±0.5	9.8±0.5	16±0.5	2.0±0.1	2.4
AFDI00303012100M04	10	100kHz,1V	3.6(3.2)	32	34	20	10 uH	6.2±0.5	9.8±0.5	16±0.5	1.8±0.1	2.2
AFDI00303012150M04	15	100kHz,1V	4.6(4.16)	28	28	20	15 uH	6.2±0.5	9.8±0.5	16±0.5	1.8±0.2	2.2
AFDI00303012220M04	22	100kHz,1V	6.83(6.43)	23	23	20	22 uH	5.75±0.5	9.25±0.5	15±0.5	1.6±0.1	2
AFDI00303012330M04	33	100kHz,1V	11.3(10.56)	18	18	20	33 uH	5.4±0.5	9.6±0.5	15±0.5	1.3±0.1	1.7
AFDI00303012470M04	47	100kHz,1V	14.6(13.45)	16.2	16	20	47 uH	5.4±0.5	9.6±0.5	15±0.5	1.3±0.1	1.7
AFDI00303012680M04	68	100kHz,1V	27(25.5)	11	12	20	68 uH	5.7±0.5	9.3±0.5	15±0.5	1.1±0.1	1.5
AFDI00303012101M04	100	100kHz,1V	32(29.71)	9	11	20	100 uH	5.7±0.5	9.3±0.5	15±0.5	1.1±0.1	1.5
AFDI00303012121M04	120	100kHz,1V	36(34.21)	8	9	20	120 uH	5.7±0.5	9.3±0.5	15±0.5	1.1±0.1	1.5

**Note: When ordering, please specify tolerance code. Tolerance: M=±20%**

1. Customized Specifications are welcome
2. Operating temperature range - 50°C ~ 155°C(Including self - temperature rise)
3. Isat for Inductance drop 20% from its value without current
4. Irms for a 40°C temperature rise from 25°C ambient with current
5. Measure Equipment:

L: WK4237  
 RDC: CHEN HWA502  
 Isat: WK3260B/ 3265  
 Irms: WK3260B/ 3265



**Leaded Power Chokes AFDI Series**

**Automotive  
AEC-Q200**

**AFDI00303012 Type**

**Characteristics Graph**

**Inductance vs. DC Current**

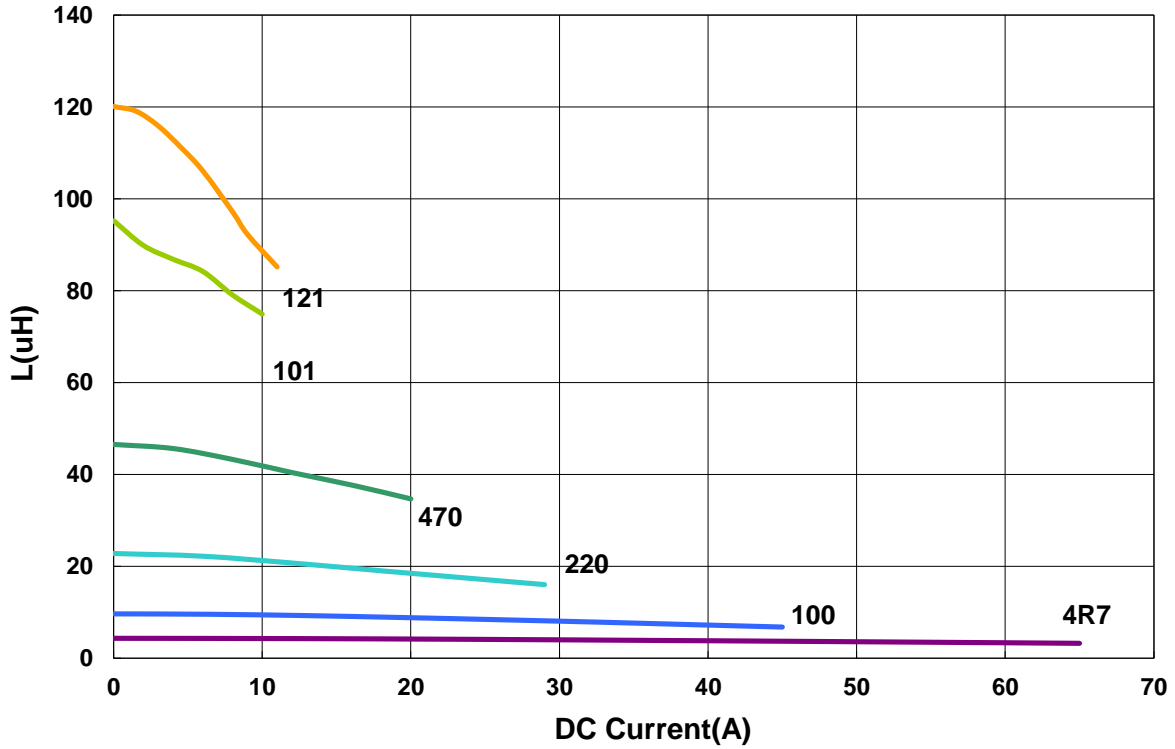

**Temperature Change vs. DC Current**

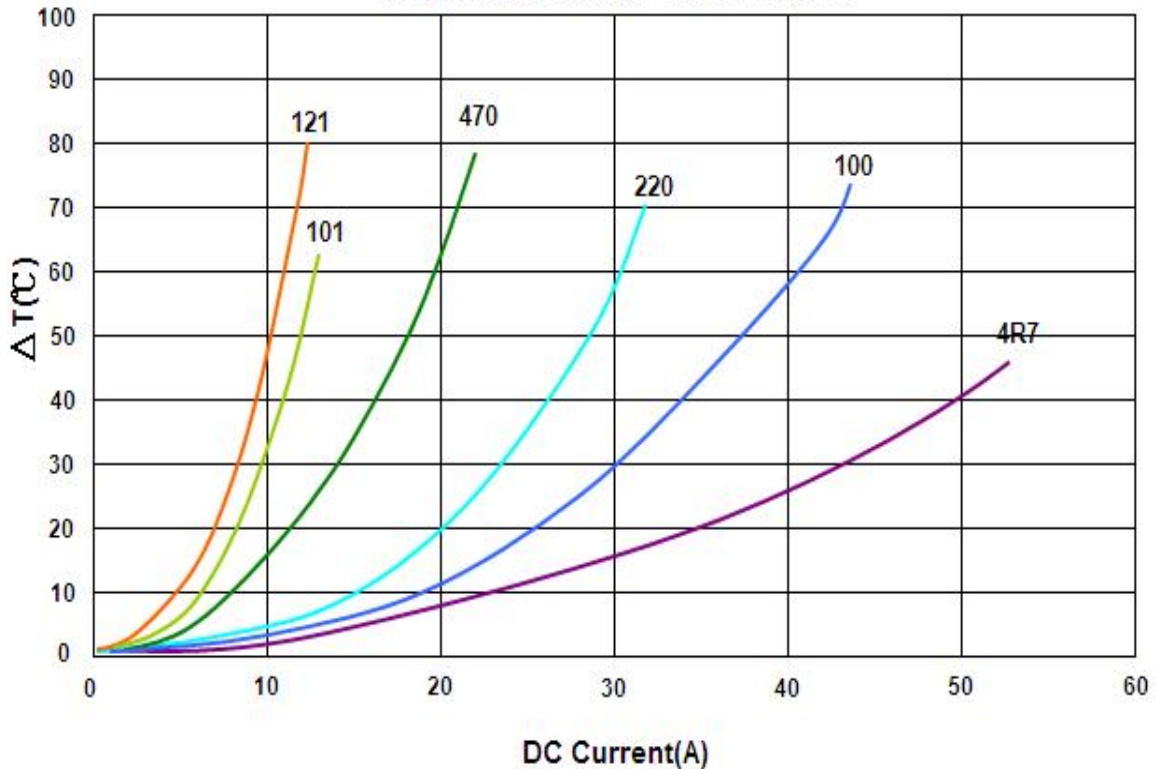

Please be sure to request approval specifications that provide further details of the products. Kindly note that the content of these specifications are subject to change or may be discontinued without prior notice. This product may not be designed/used in medical or high risk applications without Chilisin approval. Please contact our sales department before ordering.

**Leaded Power Chokes AFDI Series**

**Automotive  
AEC-Q200**

**■ Packaging**

Plate Dimensions

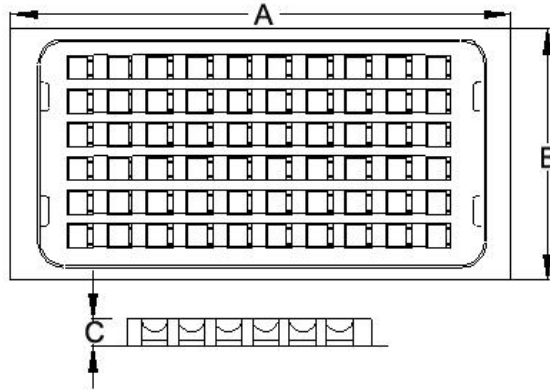

Packaging Quantity

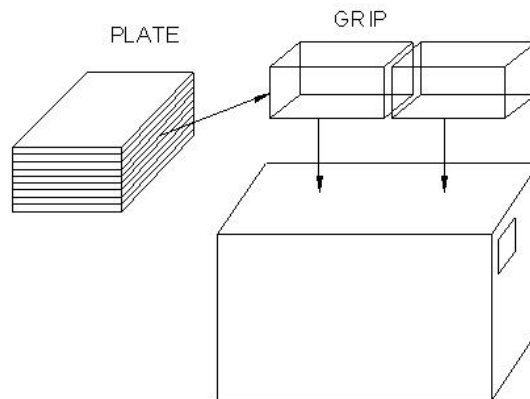

Dimensions in mm

TYPE	Plate Dimensions			Quantity				
	A	B	C	BULK	PLATE	PLATE/GRIP	GRIP	BOX
AFDI00111109	251	138	13	v	100	8	2	1600
AFDI00121210	251	138	13	v	100	8	2	1600
AFDI00131210	251	138	13	v	50	8	2	800
AFDI00161311	251	138	13	v	50	7	2	700
AFDI00191909	252	222	25.5	v	49	5	2	490
AFDI00212010	252	222	25.5	v	49	5	2	490
AFDI00282811	250	220	24	v	25	5	2	250
AFDI00303012	250	220	24	v	25	5	2	250

单击下面可查看定价，库存，交付和生命周期等信息

[>>CHILISIN\(奇力新\)](#)