

**Power Inductor APSA Series**

**Automotive  
AEC-Q200**

RoHS Compliant  
Halogen Free  
REACH Compliant



Power  
Circuit

Shield

Wire  
Wound

Ferrite

**Part Numbering**

A	PSA	00	131358	100	M	00
Grade	Series Name	Control Code	Dimensions Code (mm)	Inductance (uH)	Tolerance	Internal Code
			060630 6.3x6.3x3.0	6R0 6.0	M ±20%	
			070748 7.3x7.3x4.8	100 10	T ±30%	
			070758 7.3x7.3x5.8	101 100		
			131358 12.5x12.5x5.8			

**Power Inductor APSA Series**

**Automotive  
AEC-Q200**

**APSA00060630 Type**

**Dimensions**

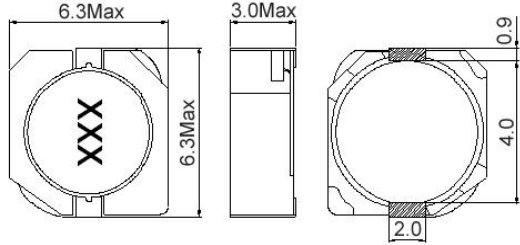

unit:mm

**Recommended Land Pattern**



unit:mm

**Electrical Characteristics**

Part No.	Inductance (uH)	Test Freq.	SRF (MHz)Min	RDC (mΩ)Max.	Isat (A)	Irms (A)	Tolerance (±%)	Marking
APSA000606306R8□00	6.8	100 kHz, 1 V	35	42	1.50	2.20	20	6R8
APSA00060630100□00	10	100 kHz, 1 V	20	63.8	1.30	1.80	20	100
APSA00060630150□00	15	100 kHz, 1 V	15	89.4	1.00	1.40	20	150
APSA00060630220□00	22	100 kHz, 1 V	10	124	0.77	1.30	20	220
APSA00060630330□00	33	100 kHz, 1 V	7	177	0.69	1.10	20	330
APSA00060630470□00	47	100 kHz, 1 V	5	252	0.59	0.92	20	470
APSA00060630680□00	68	100 kHz, 1 V	4	348	0.50	0.78	20	680
APSA00060630101□00	100	100 kHz, 1 V	4	516	0.42	0.64	20	101
APSA00060630151□00	150	100 kHz, 1 V	4	780	0.34	0.50	20	151
APSA00060630221□00	220	100 kHz, 1 V	3.2	1170	0.26	0.38	20	221

**Note: When ordering, please specify tolerance code. Tolerance: M=±20% / T=±30%**

1. Operating temperature range - 40°C ~ 125°C(Including self - temperature rise)
2. Isat for Inductance drop 30% from its value without current.
3. I rms for a 25°C temprature rise from 25°C ambient.
4. Measure Equipment:  
 L: WK6500B+WK6565  
 RDC: Chroma 16502  
 Isat: WK3260B+WK3265B

APSA00060630 Type

■ Characteristics Graph

Inductance vs. Frequency Characteristics

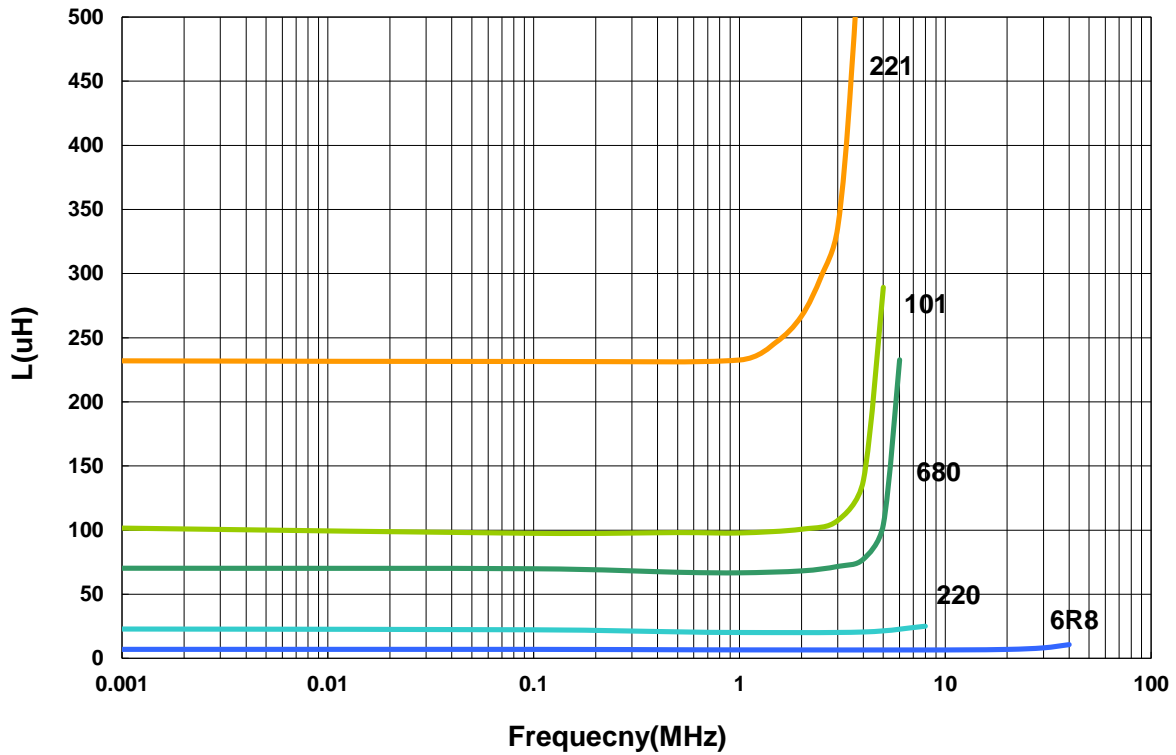

Inductance vs. DC Current

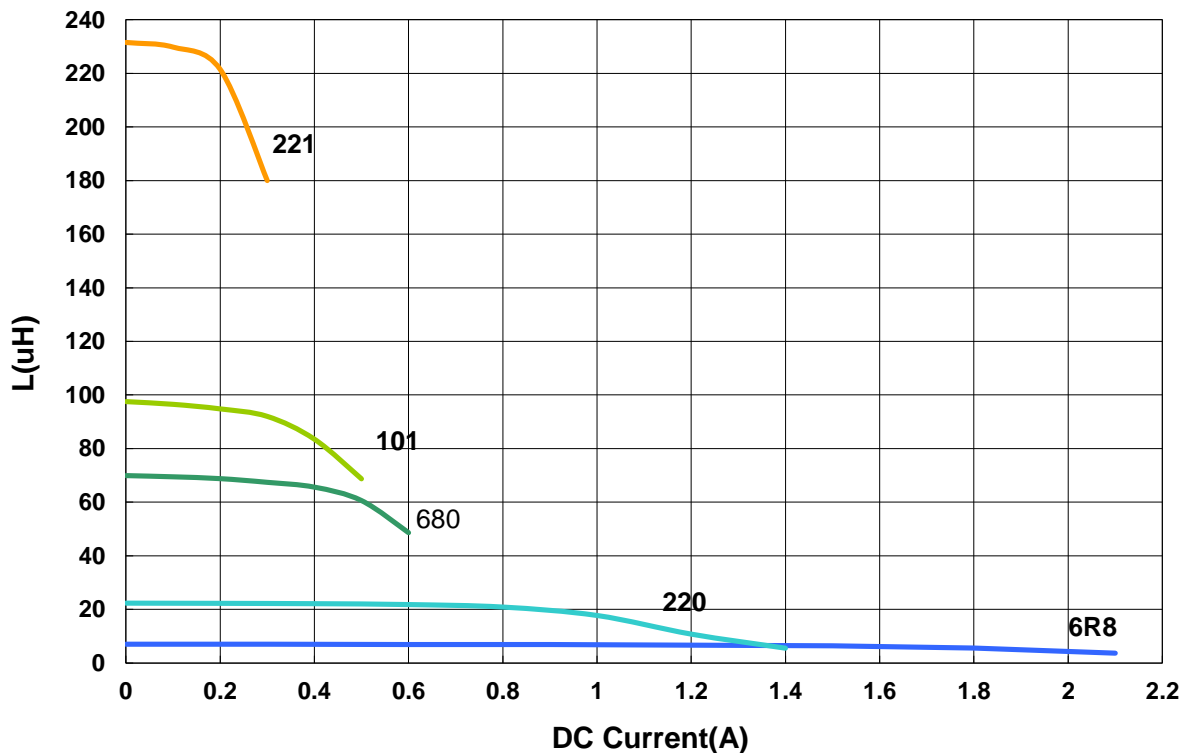

**Power Inductor APSA Series**

**Automotive  
AEC-Q200**

**APSA00070748 Type**

**■ Dimensions**

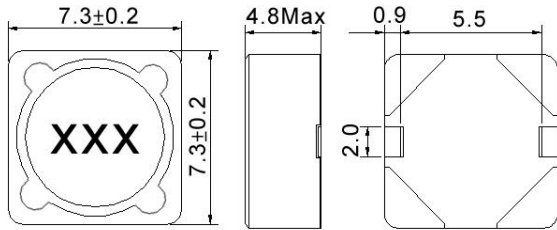

unit:mm

**■ Recommended Land Pattern**

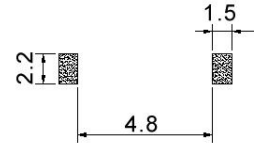

unit:mm

**■ Electrical Characteristics**

Part No.	Inductance (uH)	Test Freq.	SRF (MHz)Min	RDC (mΩ)Max.	Isat (A)	Irms (A)	Tolerance (±%)	Marking
APSA000707483R3□00	3.3	100 kHz, 1 V	90	24	2.50	2.30	20	3R3
APSA000707484R7□00	4.7	100 kHz, 1 V	65	36	2.00	2.10	20	4R7
APSA000707486R8□00	6.8	100 kHz, 1 V	24	40	1.70	1.74	20	6R8
APSA00070748100□00	10	100 kHz, 1 V	17	43.2	1.30	1.78	20	100
APSA00070748150□00	15	100 kHz, 1 V	14	62.4	1.10	1.53	20	150
APSA00070748220□00	22	100 kHz, 1 V	11	73.2	0.90	1.34	20	220
APSA00070748330□00	33	100 kHz, 1 V	10	115	0.82	1.09	20	330
APSA00070748470□00	47	100 kHz, 1 V	8.0	150	0.75	0.92	20	470
APSA00070748680□00	68	100 kHz, 1 V	7.0	210	0.60	0.77	20	680
APSA00070748101□00	100	100 kHz, 1 V	6.0	300	0.50	0.65	20	101
APSA00070748151□00	150	100 kHz, 1 V	4.0	408	0.40	0.55	20	151
APSA00070748221□00	220	100 kHz, 1 V	3.5	624	0.33	0.45	20	221
APSA00070748331□00	330	100 kHz, 1 V	3.0	880	0.25	0.37	20	331
APSA00070748471□00	470	100 kHz, 1 V	2.5	1260	0.22	0.31	20	471
APSA00070748681□00	680	100 kHz, 1 V	2.1	1770	0.20	0.27	20	681
APSA00070748102□00	1000	100 kHz, 1 V	1.1	2730	0.14	0.25	20	102

**Note: When ordering, please specify tolerance code. Tolerance: M=±20% / T=±30%**

1. Operating temperature range - 40°C ~ 125°C(Including self - temperature rise)
2. Isat for Inductance drop 10% from its value without current.
3. Irms for a 20°C temprature rise from 25°C ambient.
4. Measure Equipment:  
 L: WK6500B+WK6565  
 RDC: Chroma 16502  
 Isat: WK3260B+WK3265B

APSA00070748 Type

■ Characteristics Graph

Inductance vs. Frequency Characteristics

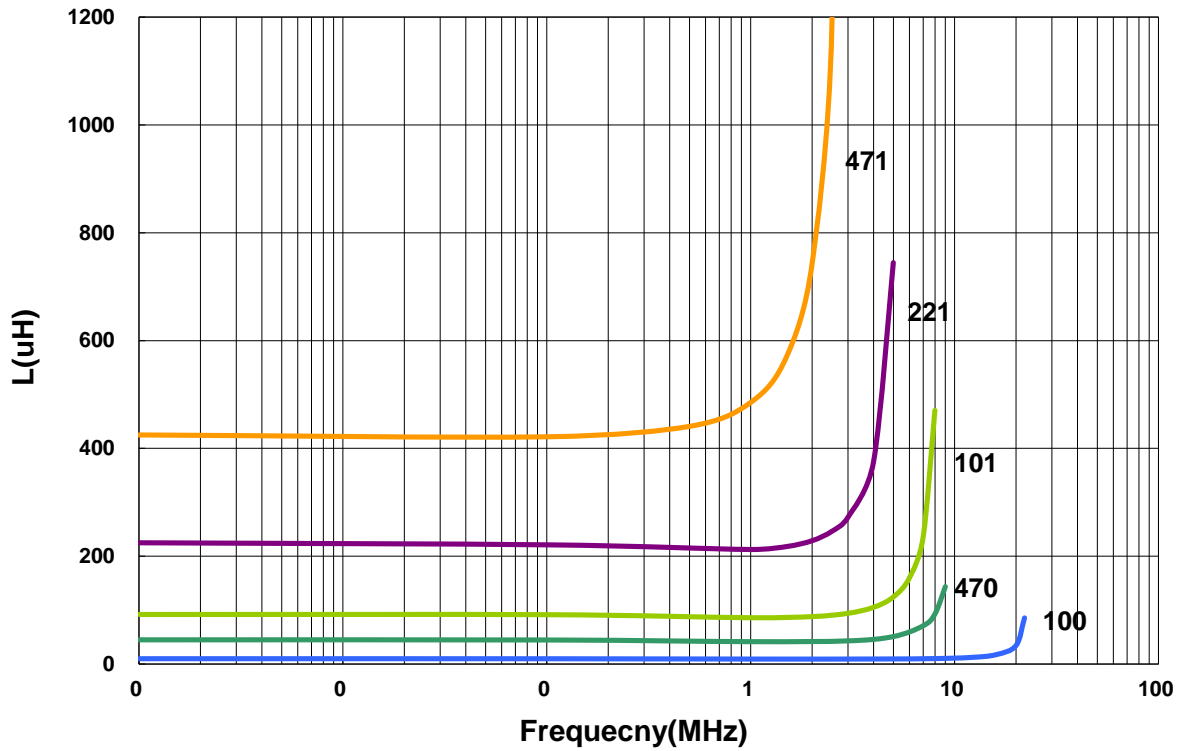

Inductance vs. DC Current

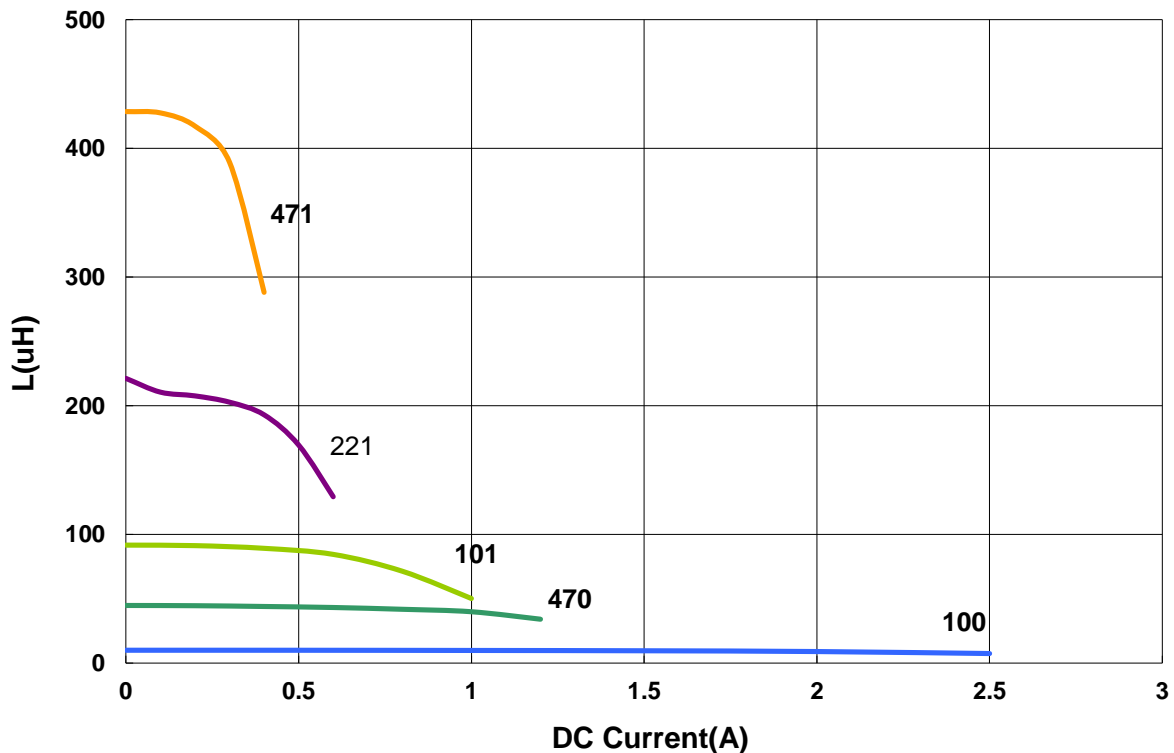

**Power Inductor APSA Series**

**Automotive  
AEC-Q200**

**APSA00070758 Type**

**■ Dimensions**

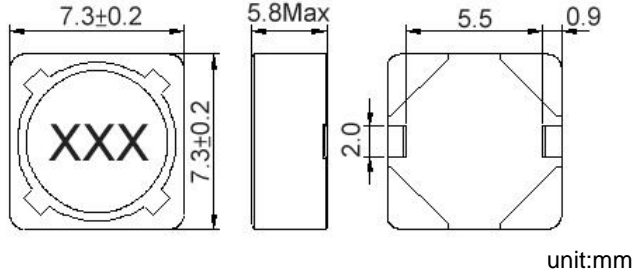

**■ Recommended Land Pattern**

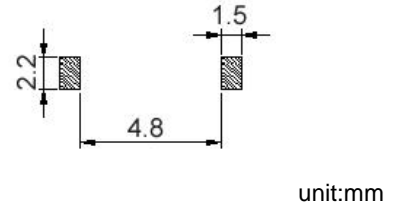

**■ Electrical Characteristics**

Part No.	Inductance (uH)	Test Freq.	SRF (MHz)Min	RDC (mΩ)Max.	Isat (A)	Irms (A)	Tolerance (±%)	Marking
APSA000707581R5□00	1.5	100 kHz, 1 V	75	20	6.2	4.0	30	1R5
APSA000707582R2□00	2.2	100 kHz, 1 V	55	23	5.3	3.5	30	2R2
APSA000707583R3□00	3.3	100 kHz, 1 V	48	31	4.3	3.3	30	3R3
APSA000707584R7□00	4.7	100 kHz, 1 V	38	36	3.6	3.1	30	4R7
APSA000707586R8□00	6.8	100 kHz, 1 V	35	44	3.0	2.8	30	6R8
APSA00070758100□00	10	100 kHz, 1 V	22	46	2.6	2.5	20	100
APSA00070758150□00	15	100 kHz, 1 V	14	60.9	2.1	2.2	20	150
APSA00070758220□00	22	100 kHz, 1 V	8	77	1.7	2.0	20	220

**Note: When ordering, please specify tolerance code. Tolerance: M=±20% / T=±30%**

1. Operating temperature range - 40°C ~ 125°C(Including self - temperature rise)
2. Isat for Inductance drop 10% from its value without current.
3. I rms for a 30°C temprature rise from 25°C ambient.
4. Measure Equipment:  
 L: WK6500B+WK6565  
 RDC: Chroma 16502  
 Isat: WK3260B+WK3265B

APSA00070758 Type

■ Characteristics Graph

Inductance vs. Frequency Characteristics

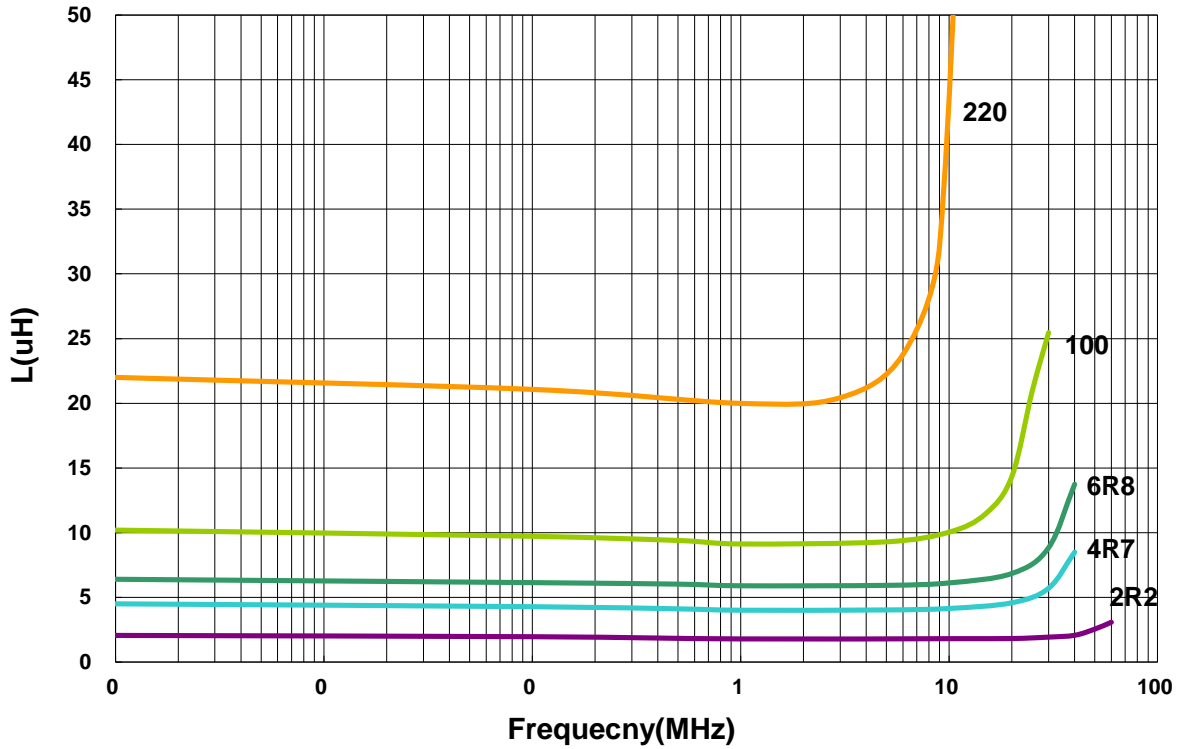

Inductance vs. DC Current

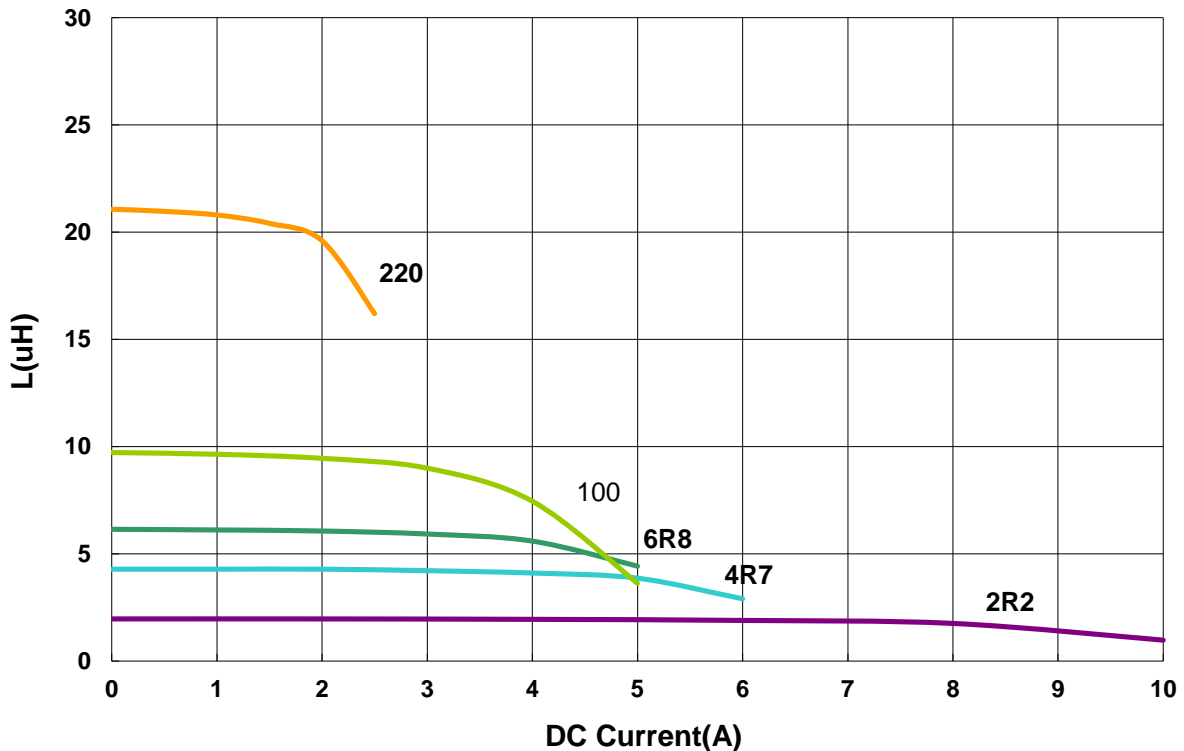

**Power Inductor APSA Series**

**Automotive  
AEC-Q200**

**APSA00131358 Type**

**■ Dimensions**

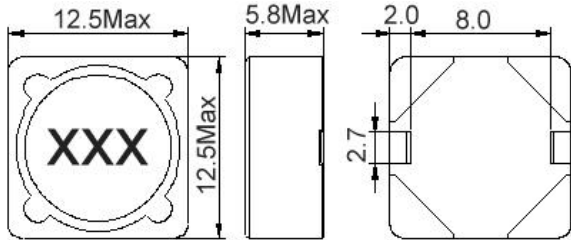

unit:mm

**■ Recommended Land Pattern**

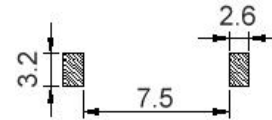

unit:mm

**■ Electrical Characteristics**

Part No.	Inductance (uH)	Test Freq.	SRF (MHz)Min	RDC (mΩ)Max.	Isat (A)	Irms (A)	Tolerance (±%)	Marking
APSA001313586R0□00	6.0	1 kHz,1 V	26	19.7	3.6	4.9	30	6R0
APSA00131358100□00	10	1 kHz,1 V	17	25.8	3.4	4.3	20	100
APSA00131358150□00	15	1 kHz,1 V	15	31.0	2.8	3.9	20	150
APSA00131358220□00	22	1 kHz,1 V	11	40.6	2.3	3.4	20	220
APSA00131358330□00	33	1 kHz,1 V	10	49.8	1.9	3.1	20	330
APSA00131358470□00	47	1 kHz,1 V	8	74.2	1.6	2.5	20	470
APSA00131358680□00	68	1 kHz,1 V	7	99.8	1.3	2.2	20	680
APSA00131358101□00	100	1 kHz,1 V	5.5	140	1.1	1.8	20	101
APSA00131358151□00	150	1 kHz,1 V	4.5	228	0.88	1.4	20	151
APSA00131358221□00	220	1 kHz,1 V	3.0	324	0.72	1.2	20	221
APSA00131358331□00	330	1 kHz,1 V	3.0	492	0.59	1.0	20	331
APSA00131358471□00	470	1 kHz,1 V	2.5	624	0.49	0.88	20	471
APSA00131358681□00	680	1 kHz,1 V	2.0	912	0.43	0.73	20	681
APSA00131358102□00	1000	1 kHz,1 V	1.7	1344	0.34	0.60	20	102
APSA00131358152□00	1500	1 kHz,1 V	1.4	2076	0.29	0.48	20	152

**Note: When ordering, please specify tolerance code. Tolerance: M=±20% / T=±30%**

1. Operating temperature range - 40°C ~ 125°C(Including self - temperature rise)
2. Isat for Inductance drop 10% from its value without current.
3. I rms for a 30°C temprature rise from 25°C ambient.

4. Measure Equipment:

L: WK6500B+WK6565

RDC: Chroma 16502

Isat: WK3260B+WK3265B



APSA00131358 Type

■ Characteristics Graph

Inductance vs. Frequency Characteristics

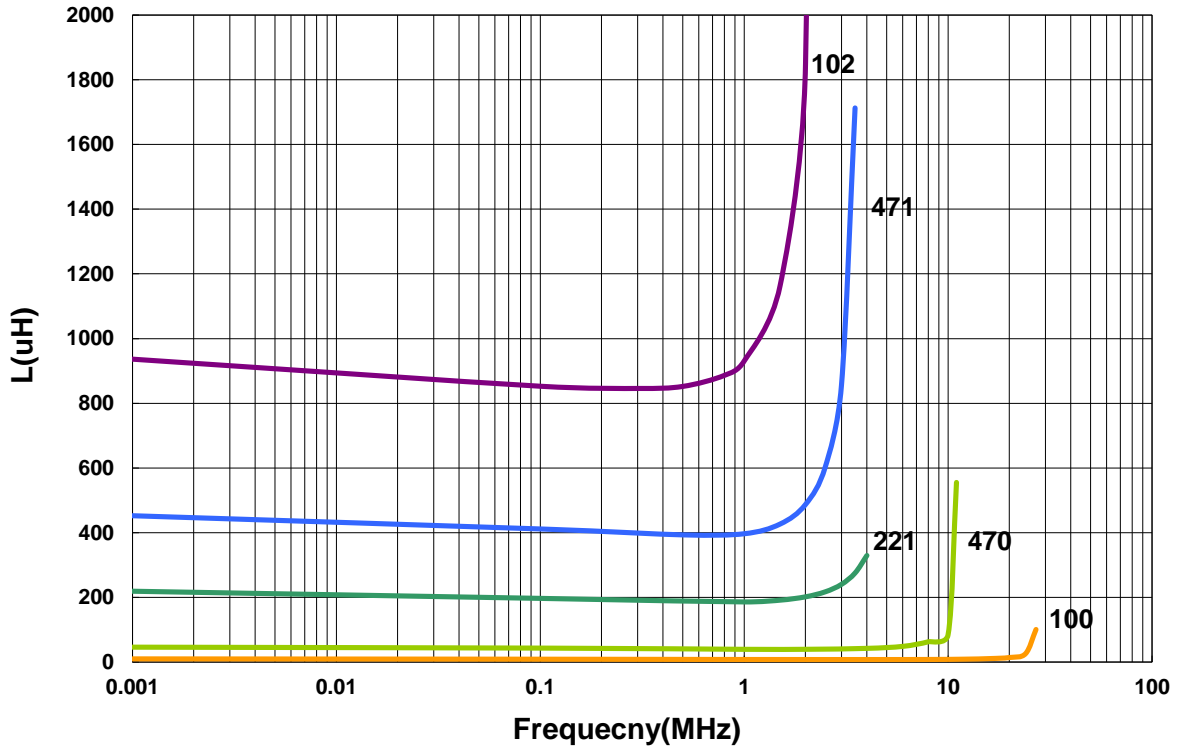

Inductance vs. DC Current

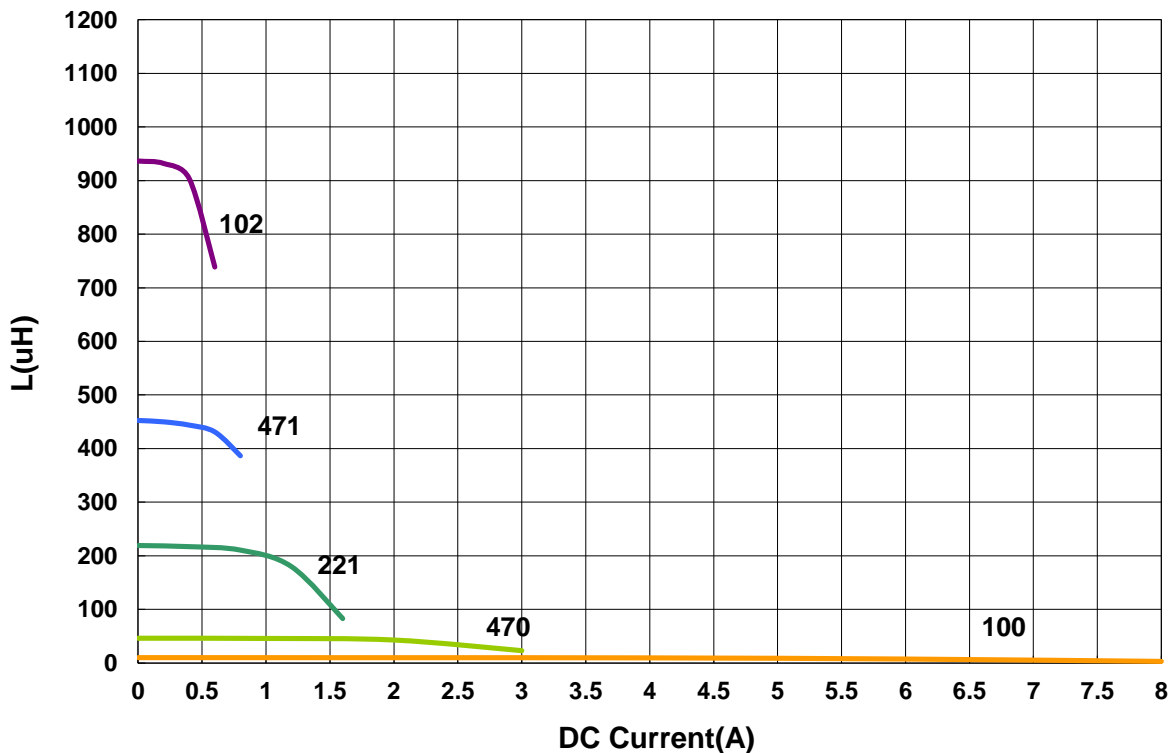

**Power Inductor APSA Series**

**Automotive  
AEC-Q200**

**■ Packaging**

Tape Dimensions

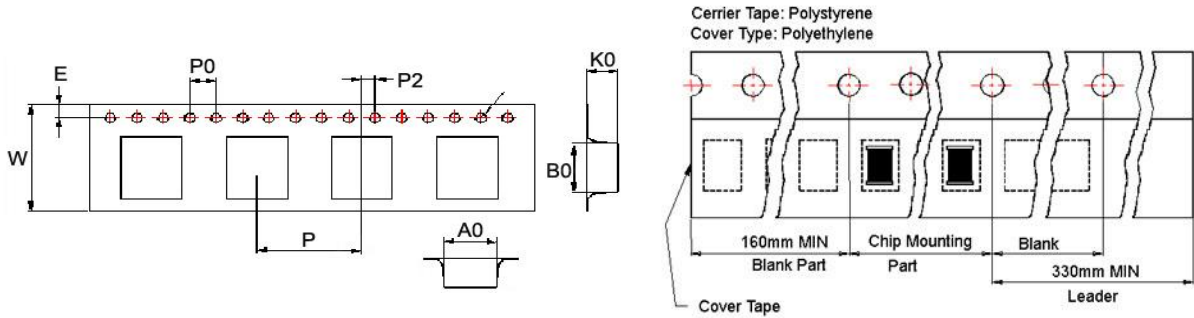

Reel Dimensions

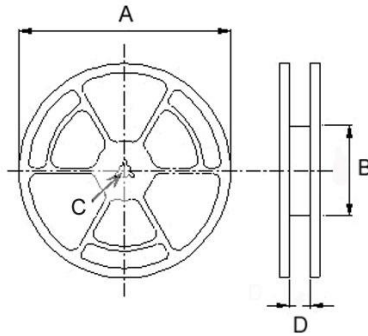

Dimensions in mm

TYPE	Tape Dimensions									Reel Dimensions				Quantity PCS / REEL
	A0	B0	K0	D	E	W	P	P0	P2	A	B	C	D	
APSA00060630	6.3	6.55	3.3	1.55	1.75	16	12	4	2	330	100	13	16.0	1000
APSA00070748	7.6	7.6	5.2	1.55	1.75	16	12	4	2	330	100	13	16.0	1000
APSA00070758	7.8	7.8	6.0	1.55	1.75	16	12	4	2	330	100	13	16.0	900
APSA00131358	12.6	12.6	6.7	1.55	1.75	24	16	4	2	330	100	13	24.2	600

单击下面可查看定价，库存，交付和生命周期等信息

[>>CHILISIN\(奇力新\)](#)