

BDUE Series



Through material optimization, BDUE Series is with better electrical characteristics, such as: better efficiency performance, higher Q factor, and higher Irms. Compared to BDHE series, the RDC of BDUE series can also be reduced by 10% to 25%.

Features

- RoHS, Halogen Free and REACH Compliance
- High Efficiency
- Excellent Q, RDC and Irms
- Low profile and miniature size down to 2.0*1.6*1.0mm

Applications

- Smartphones, tablets and wearable devices
- HDD, SSD and PC peripheral devices
- DSC, camcorders
- PND
- DC/DC converters

Product Identification

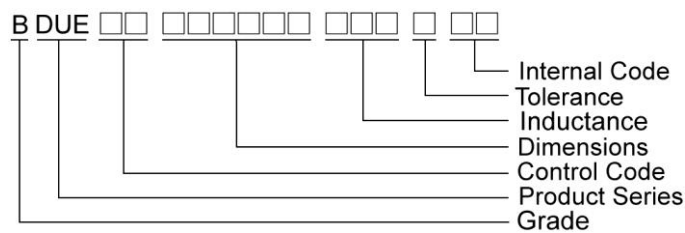

Shape and Dimensions

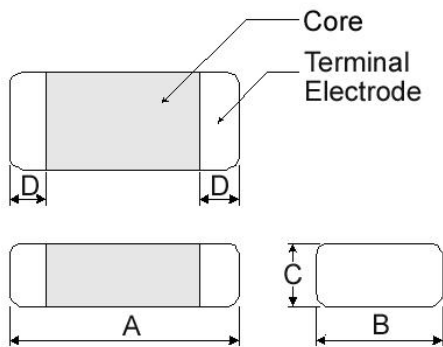

Dimensions in mm

TYPE	A	B	C	D
BDUE00201208	2.0±0.2	1.25±0.2	0.8Max	0.5±0.3
BDUE00201610	2.0±0.2	1.60±0.2	1.0Max	0.5±0.3
BDUE00252010	2.5±0.3	2.00±0.3	1.0Max	0.6±0.3
BDUE00252012	2.5±0.3	2.00±0.3	1.2Max	0.6±0.3

Recommended Pattern

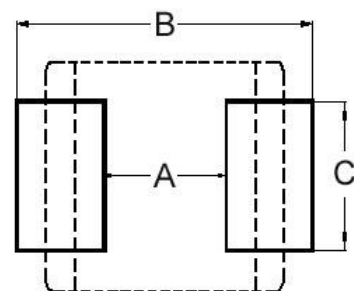

Dimensions in mm

TYPE	A	B	C
BDUE00201208	0.8~1.2	2.3~2.9	1.0~1.45
BDUE00201610	0.7	2.3	1.8
BDUE00252010	1.2	2.8	2.3
BDUE00252012	1.2	2.8	2.3

Molding Power Inductors – BDUE Series

Electrical Characteristics

Part Number	Inductance (uH)	Tolerance (±%)	Test Frequency (MHz)	RDC(mΩ) Max(Typ.)	Isat(A) Max(Typ.)	Irms(A) Max(Typ.)
BDUE00201208R47MQ1	0.47	20	2	43(37)	3.5(3.6)	3.0(3.2)

Note: When ordering, please specify tolerance code. Tolerance: M=±20%

- Operating temperature range - 40°C ~ 125°C(Including self - temperature rise)
- Isat for Inductance drop 30% from its value without current
- I rms for a 40°C temperature rise from 25°C ambient with current
- Rated current : Isat or I rms, whichever is smaller
- Absolute maximum voltage 20VDC
- Measure Equipment :
 L : Agilent E4991/HP4286A+16197A (or equivalent), 2MHz 0.2V
 RDC : CHEN HWA502BC/HP4338B (or equivalent)
 Isat : Agilent E4980A+HP42841A (or equivalent)
 I rms : Agilent 6641 SYSTEM DC POWER SUPPLY (or equivalent)

Test Instruments : E4991A Impedance / Material Analyzer

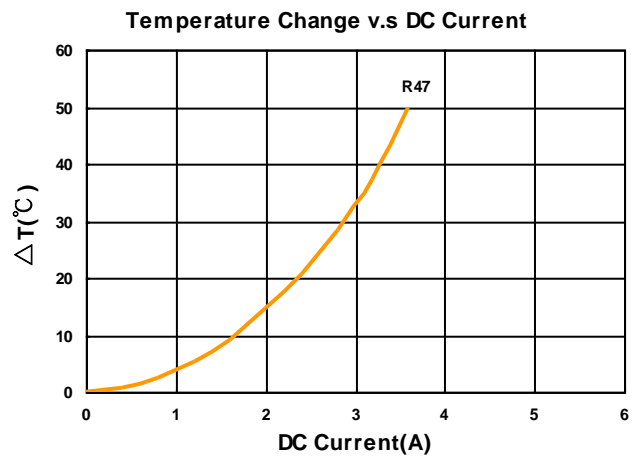
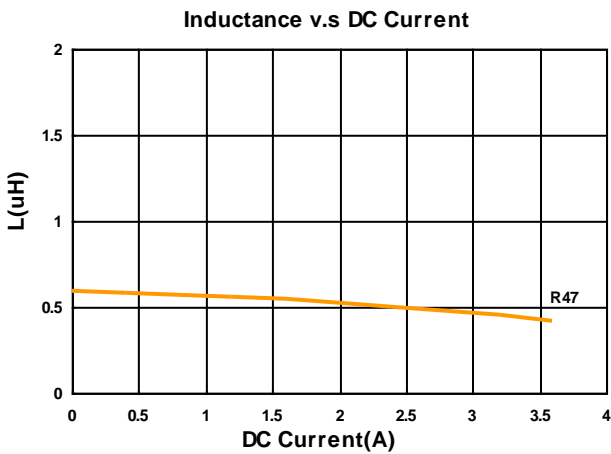

Molding Power Inductors – BDUE Series

Electrical Characteristics

Part Number	Inductance (uH)	Tolerance (±%)	Test Frequency (MHz)	RDC(mΩ) Max(Typ.)	Isat(A) Max(Typ.)	Irms(A) Max(Typ.)
BDUE00201610R47MQ1	0.47	20	2	36(30)	3.5(3.9)	3.1(3.5)
BDUE002016101R0MQ1	1.0	20	2	60(50)	3.0(3.2)	2.7(3.0)

Note: When ordering, please specify tolerance code. Tolerance: M=±20%

- Operating temperature range - 40°C ~ 125°C(Including self - temperature rise)
- Isat for Inductance drop 30% from its value without current
- I rms for a 40°C temperature rise from 25°C ambient with current
- Rated current : Isat or I rms, whichever is smaller
- Absolute maximum voltage 20VDC
- Measure Equipment :
 L : Agilent E4991/HP4286A+16197A (or equivalent), 2MHz 0.2V
 RDC : CHEN HWA502BC/HP4338B (or equivalent)
 Isat : Agilent E4980A+HP42841A (or equivalent)
 I rms : Agilent 6641 SYSTEM DC POWER SUPPLY (or equivalent)

Test Instruments : E4991A Impedance / Material Analyzer

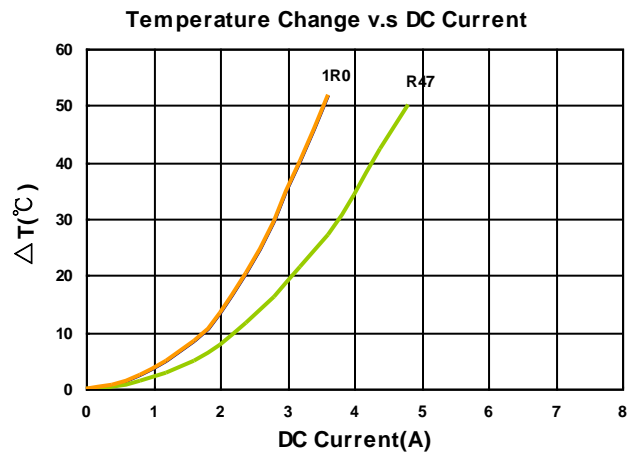
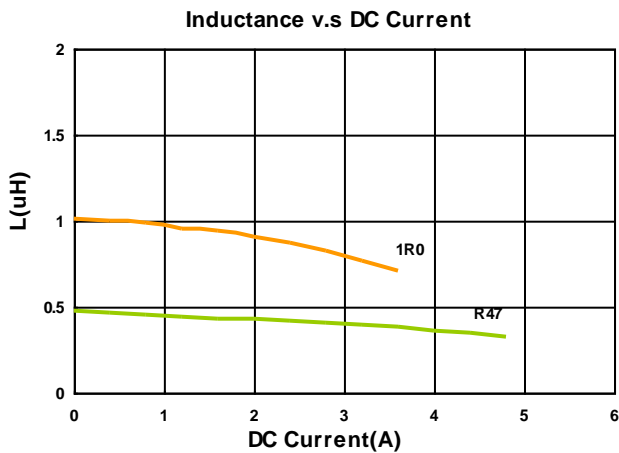

Molding Power Inductors – BDUE Series

Electrical Characteristics

Part Number	Inductance (uH)	Tolerance (±%)	Test Frequency (MHz)	RDC(mΩ) Max(Typ.)	Isat(A) Max(Typ.)	Irms(A) Max(Typ.)
BDUE00252010R47MQ1	0.47	20	2	27(21)	5.5(6.5)	4.2(4.5)
BDUE002520101R0MQ1	1.0	20	2	46(39)	4.7(5.2)	4.0(4.2)

Note: When ordering, please specify tolerance code. Tolerance: M=±20%

- Operating temperature range - 40°C ~ 125°C(Including self - temperature rise)
- Isat for Inductance drop 30% from its value without current
- I rms for a 40°C temperature rise from 25°C ambient with current
- Rated current : Isat or I rms, whichever is smaller
- Absolute maximum voltage 20VDC
- Measure Equipment :
 - L : Agilent E4991/HP4286A+16197A (or equivalent), 2MHz 0.2V
 - RDC : CHEN HWA502BC/HP4338B (or equivalent)
 - Isat : Agilent E4980A+HP42841A (or equivalent)
 - I rms : Agilent 6641 SYSTEM DC POWER SUPPLY (or equivalent)

Test Instruments : E4991A Impedance / Material Analyzer

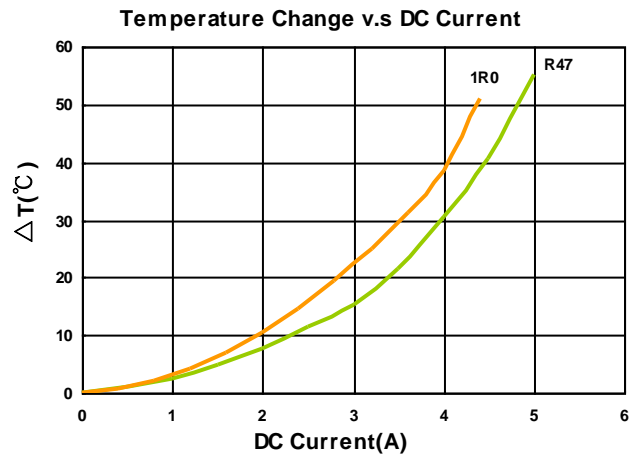
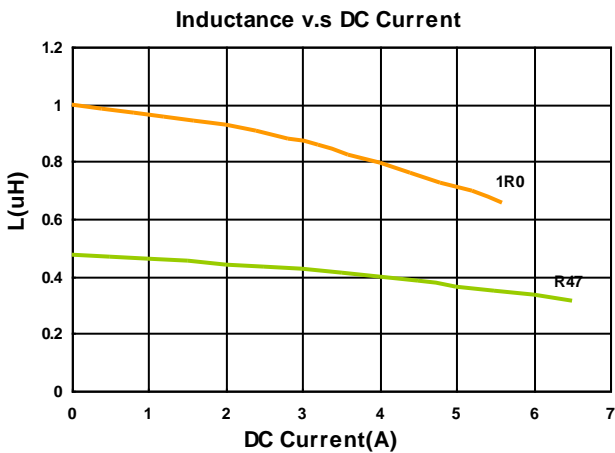

Molding Power Inductors – BDUE Series

Electrical Characteristics

Part Number	Inductance (uH)	Tolerance (±%)	Test Frequency (MHz)	RDC(mΩ) Max(Typ.)	Isat(A) Max(Typ.)	Irms(A) Max(Typ.)
BDUE00252012R47MQ1	0.47	20	2	26.5(22.5)	5.7(7.0)	4.5(4.7)
BDUE002520121R5MQ1	1.5	20	2	59(51)	3.4(3.7)	2.7(3.0)

Note: When ordering, please specify tolerance code. Tolerance: M=±20%

- Operating temperature range - 40°C ~ 125°C(Including self - temperature rise)
- Isat for Inductance drop 30% from its value without current
- I rms for a 40°C temperature rise from 25°C ambient with current
- Rated current : Isat or I rms, whichever is smaller
- Absolute maximum voltage 20VDC
- Measure Equipment :
 - L : Agilent E4991/HP4286A+16197A (or equivalent), 2MHz 0.2V
 - RDC : CHEN HWA502BC/HP4338B (or equivalent)
 - Isat : Agilent E4980A+HP42841A (or equivalent)
 - I rms : Agilent 6641 SYSTEM DC POWER SUPPLY (or equivalent)

Test Instruments : E4991A Impedance / Material Analyzer

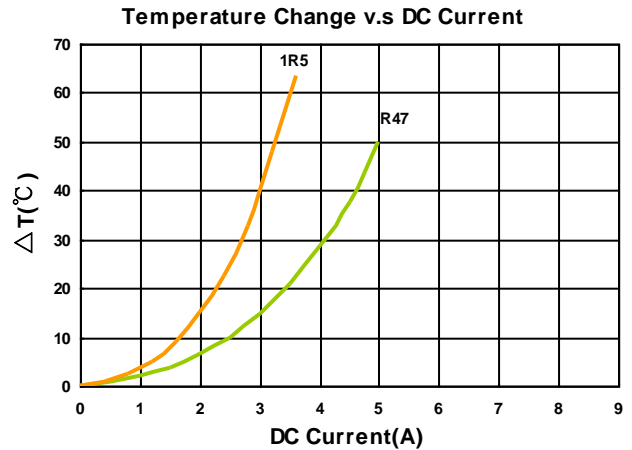
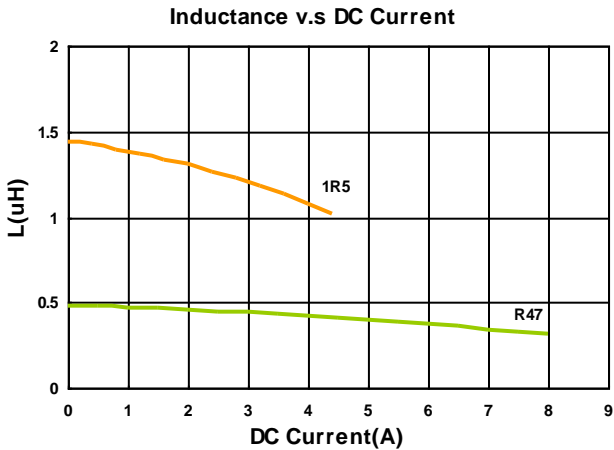

Packaging Specifications

Tape Dimensions

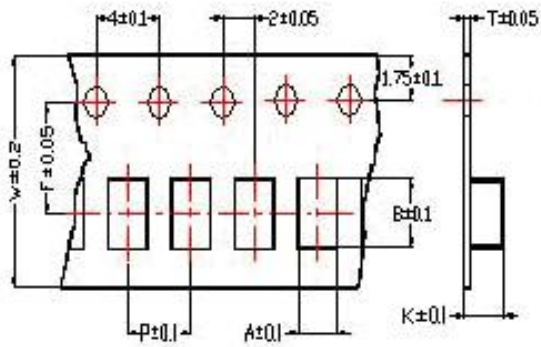

Tape Material

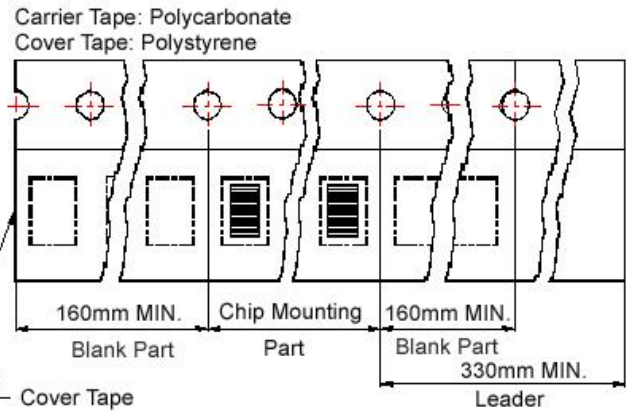

Reel Dimensions

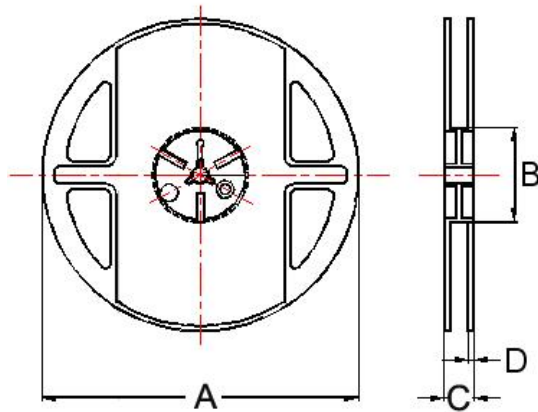

Dimensions in mm

TYPE	Tape Dimensions							Reel Dimensions				Quantity PCS / REEL
	A	B	T	W	P	F	K	A	B	C	D	
BDUE00201208	1.45	2.25	0.22	8	4	3.5	1.04	178	60	12	1.5	3000
BDUE00201610	1.80	2.20	0.22	8	4	3.5	1.15	178	60	12	1.5	3000
BDUE00252010	2.25	2.80	0.22	8	4	3.5	1.15	178	60	12	1.5	3000
BDUE00252012	2.25	2.80	0.22	8	4	3.5	1.35	178	60	12	1.5	3000

单击下面可查看定价，库存，交付和生命周期等信息

[>>CHILISIN\(奇力新\)](#)