

BMMN Series



BMMN Series is designed for low profile type with low RDC and ultra large current. Its molded magnetic shielded type is suitable for high-density mounting and ultra low buzz noise. Soldering conditions can be easily confirmed when mounting onto the board. This series also provides customers with embossed carrier type packaging for automatic mounting machine.

Features

- RoHS, Halogen Free and REACH Compliance
- Low resistance and high current rating
- Magnetic core made by high performance magnetic powder

Applications

- Laptop and desktop applications
- High current power supplies
- PMIC
- DC/DC converters

Product Identification

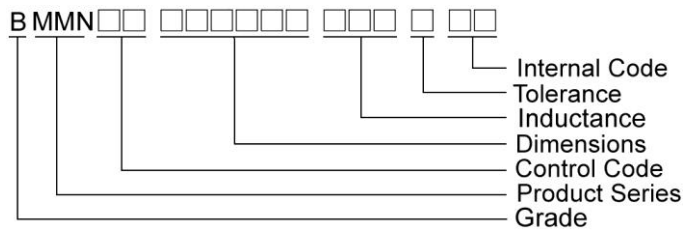

Shape and Dimensions

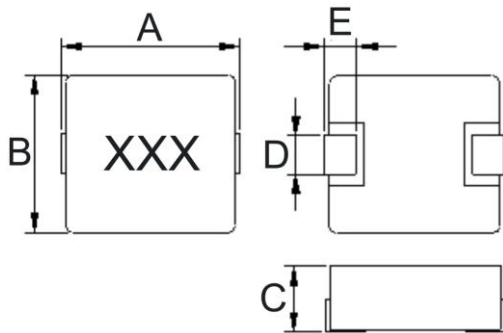

Dimensions in mm

TYPE	A	B	C	D	E
BMMN00040412	4.45±0.25	4.06±0.25	1.2Max	2.0±0.3	0.76±0.3
BMMN00040420	4.45±0.25	4.06±0.25	2.0Max	2.0±0.3	0.76±0.3
BMMN00050512	5.49±0.25	5.18±0.22	1.2Max	2.0±0.3	1.0±0.3
BMMN00050515	5.49±0.25	5.18±0.22	1.5Max	2.0±0.3	1.0±0.3
BMMN00050518	5.49±0.25	5.18±0.22	1.8Max	2.0±0.3	1.0±0.3
BMMN00050530	5.3Max	4.7±0.2	3.0Max	2.0±0.2	1.0±0.3
BMMN00060615	6.86±0.38	6.47±0.25	1.5Max	3.0±0.3	1.3±0.3
BMMN00060618	7.4Max	6.6±0.2	1.8Max	3.0±0.3	1.6±0.3
BMMN00060630	6.95±0.35	6.6±0.2	3.0Max	3.0±0.3	1.6±0.3

Recommended Pattern

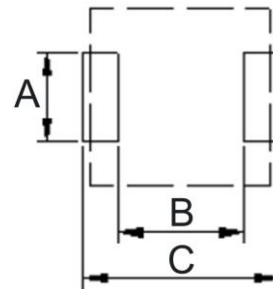

Dimensions in mm

TYPE	A	B	C
BMME00040412	2.5	2.2	5.2
BMME00040420	2.5	2.2	5.2
BMMN00050512	2.5	2.2	5.99
BMMN00050515	2.5	2.2	5.99
BMMN00050518	2.5	2.2	5.99
BMMN00050530	2.5	3.0	7.0
BMMN00060615	3.43	3.71	7.37
BMMN00060618	3.5	3.7	8.4
BMMN00060630	3.5	3.7	8.4

Molding Power Inductors – BMMN Series

Electrical Characteristics

Part Number	Inductance (uH)	Tolerance (±%)	Test Frequency (kHz)	RDC(mΩ) Max(Typ.)	Isat (A)Typ.	Irms (A)Typ.	Marking
BMMN000404121R0MX2	1.0	20	100	47(43)	5.2	4.2	1R0
BMMN000404122R2MX2	2.2	20	100	83.5(79.4)	3.5	2.75	2R2

Note: When ordering, please specify tolerance code. Tolerance: M=±20%

- Operating temperature range - 55°C ~ 125°C(Including self - temperature rise)
- Isat for Inductance drop 30% from its value without current
- I rms for a 40°C temperature rise from 25°C ambient with current
- Measure Equipment :
 L : WK 3260B or WK 6500P, 100kHz 0.25V
 RDC : CHEN HWA 502 or CHEN HWA 46502B
 I rms : CHROMA 1810

Test Instruments : WK3260B Impedance / Material Analyzer

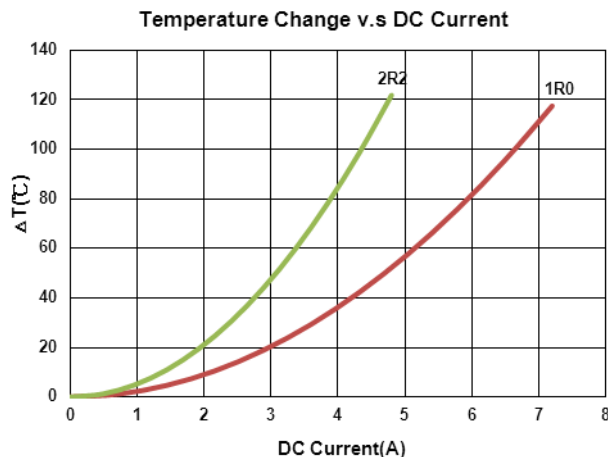
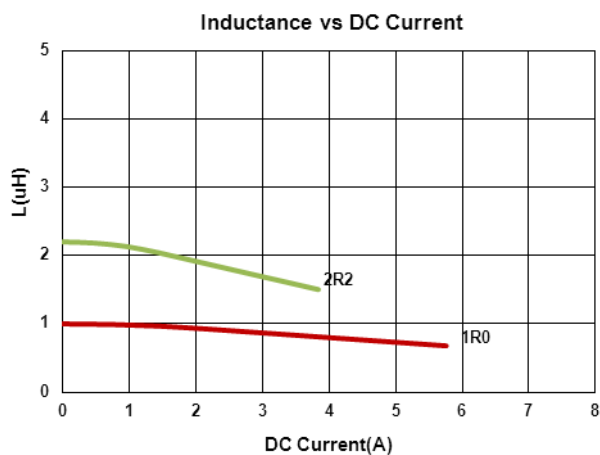

Molding Power Inductors – BMMN Series

Electrical Characteristics

Part Number	Inductance (uH)	Tolerance (±%)	Test Frequency (kHz)	RDC(mΩ) Max(Typ.)	Isat (A)Typ.	Irms (A)Typ.	Marking
BMMN000404201R5MX2	1.5	20	100	43(35)	6	4	1R5

Note: When ordering, please specify tolerance code. Tolerance: M=±20%

- Operating temperature range - 55°C ~ 125°C(Including self - temperature rise)
- Isat for Inductance drop 30% from its value without current
- Irms for a 40°C temperature rise from 25°C ambient with current
- Measure Equipment :
 L : WK 3260B or WK 6500P, 100kHz 0.25V
 RDC : CHEN HWA 502 or CHEN HWA 46502B
 Irms : CHROMA 1810

Test Instruments : WK3260B Impedance / Material Analyzer

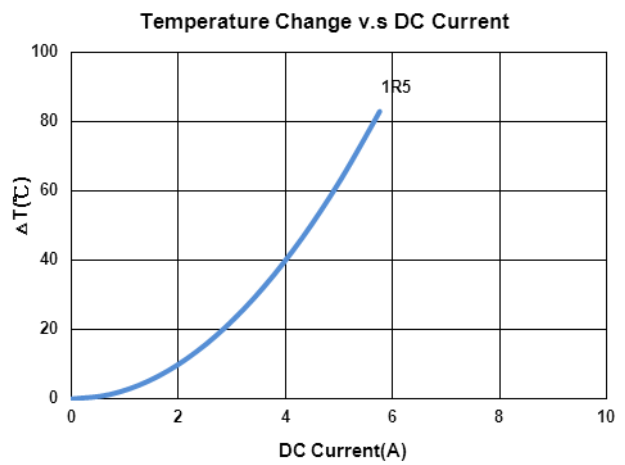
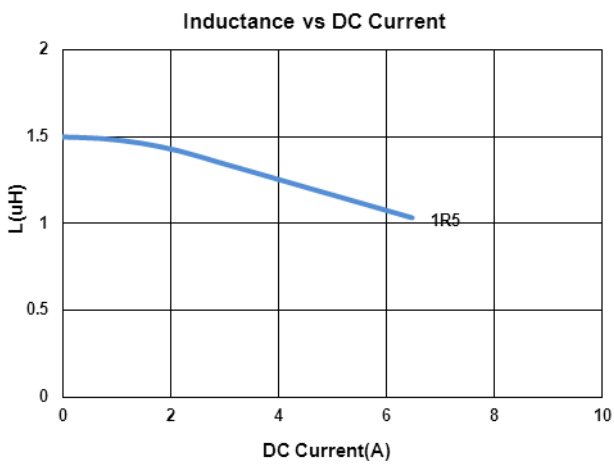

Molding Power Inductors – BMMN Series

Electrical Characteristics

Part Number	Inductance (uH)	Tolerance (±%)	Test Frequency (kHz)	RDC(mΩ) Max(Typ.)	Isat (A)Typ.	Irms (A)Typ..	Marking
BMMN000505122R2MX1	2.2	20	100	76(67)	4	3.5	2R2

Note: When ordering, please specify tolerance code. Tolerance: M=±20%

- Operating temperature range - 55°C ~ 125°C(Including self - temperature rise)
- Isat for Inductance drop 30% from its value without current
- Irms for a 40°C temperature rise from 25°C ambient with current
- Measure Equipment :
 L : WK 3260B or WK 6500P, 100kHz 0.25V
 RDC : CHEN HWA 502 or CHEN HWA 46502B
 Irms : CHROMA 1810

Test Instruments : WK3260B Impedance / Material Analyzer

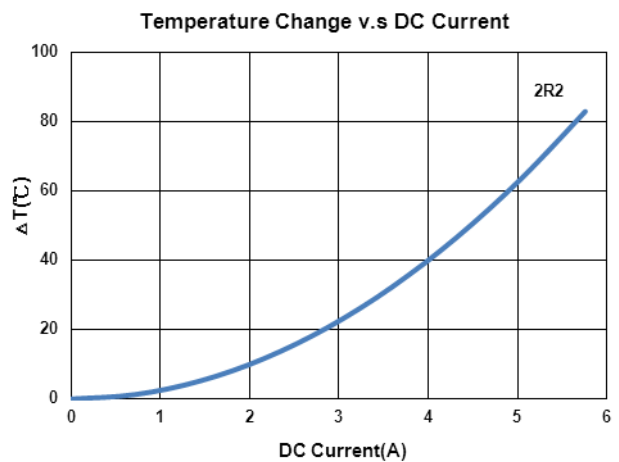
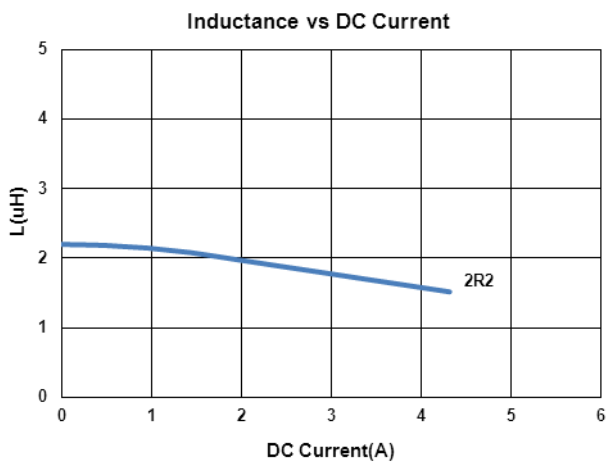

Molding Power Inductors – BMMN Series

Electrical Characteristics

Part Number	Inductance (uH)	Tolerance (±%)	Test Frequency (kHz)	RDC(mΩ) Max(Typ.)	Isat(A) Max(Typ.)	Irms(A) Max(Typ.)	Marking
BMMN00050512R68MX2	0.68	20	100	22(19)	7.4(8.5)	6.0(6.7)	R68

Note: When ordering, please specify tolerance code. Tolerance: M=±20%

- Operating temperature range - 55°C ~ 125°C(Including self - temperature rise)
- Isat for Inductance drop 30% from its value without current
- I rms for a 40°C temperature rise from 25°C ambient with current
- Measure Equipment :
 L : WK 3260B or WK 6500P, 100kHz 0.25V
 RDC : CHEN HWA 502 or CHEN HWA 46502B
 I rms : CHROMA 1810

Test Instruments : WK3260B Impedance / Material Analyzer

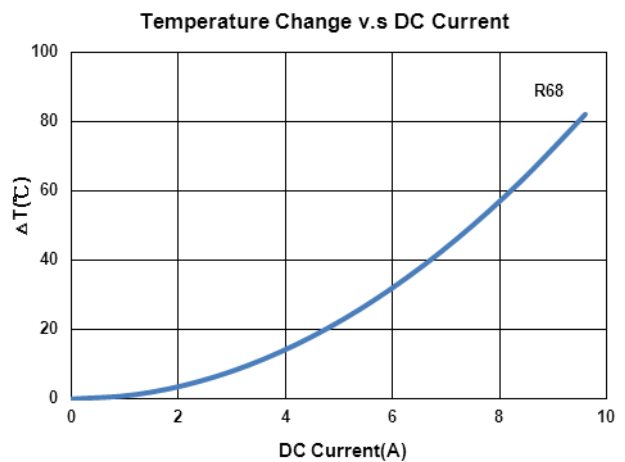
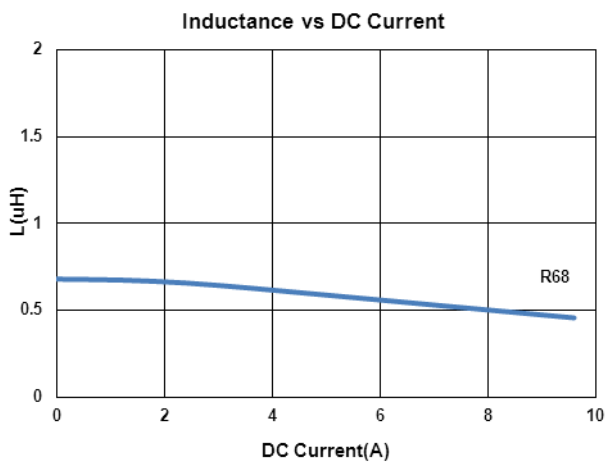

Molding Power Inductors – BMMN Series

Electrical Characteristics

Part Number	Inductance (uH)	Tolerance (±%)	Test Frequency (kHz)	RDC(mΩ) Max(Typ.)	Isat (A)Typ.	Irms (A)Typ..	Marking
BMMN000505151R0MX2	1.0	20	100	23(20)	9	6.5	1R0
BMMN000505154R7MX2	4.7	20	100	106(95)	4	3	4R7
BMMN00050515100MX2	10	20	100	170(153)	3	2	100

Note: When ordering, please specify tolerance code. Tolerance: M=±20%

- Operating temperature range - 55°C ~ 125°C(Including self - temperature rise)
- Isat for Inductance drop 30% from its value without current
- Irms for a 40°C temperature rise from 25°C ambient with current
- Measure Equipment :
 L : WK 3260B or WK 6500P, 100kHz 0.25V
 RDC : CHEN HWA 502 or CHEN HWA 46502B
 Irms : CHROMA 1810

Test Instruments : WK3260B Impedance / Material Analyzer

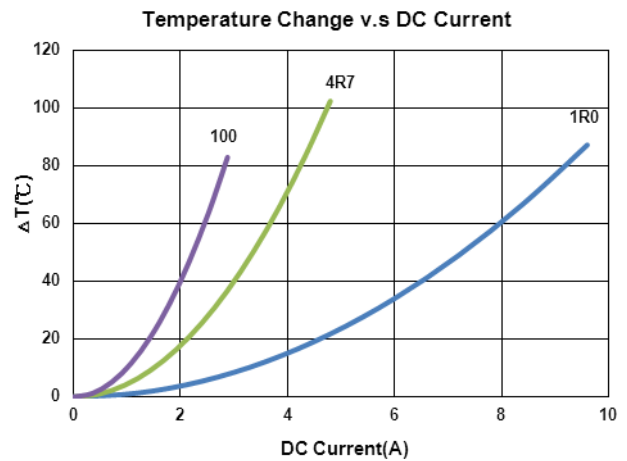
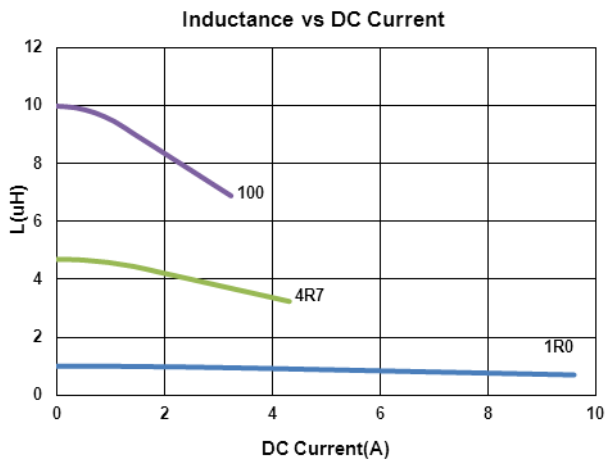

Molding Power Inductors – BMMN Series

Electrical Characteristics

Part Number	Inductance (uH)	Tolerance (±%)	Test Frequency (kHz)	RDC(mΩ) Max(Typ.)	Isat(A) Max(Typ.)	Irms(A) Max(Typ.)	Marking
BMMN000505181R0MX1	1.0	20	100	18(15)	8.6(10)	7.5(8.5)	1R0
BMMN000505181R5MX1	1.5	20	100	28(23)	7.2(9)	5.5(6.5)	1R5
BMMN000505182R2MX1	2.2	20	100	35(30)	6(7)	4.7(5.2)	2R2

Note: When ordering, please specify tolerance code. Tolerance: M=±20%

- Operating temperature range - 55°C ~ 125°C(Including self - temperature rise)
- Isat for Inductance drop 30% from its value without current
- I rms for a 40°C temperature rise from 25°C ambient with current
- Measure Equipment :
 L : WK 3260B or WK 6500P, 100kHz 0.25V
 RDC : CHEN HWA 502 or CHEN HWA 46502B
 I rms : CHROMA 1810

Test Instruments : WK3260B Impedance / Material Analyzer

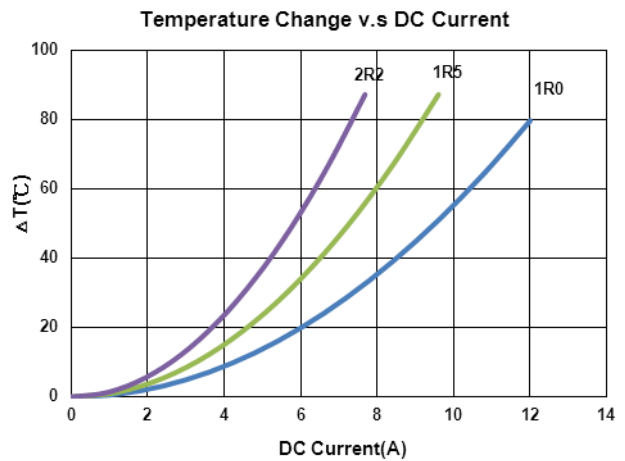
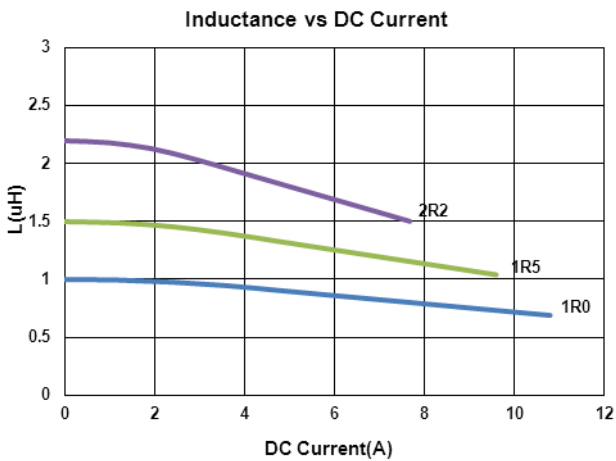

Molding Power Inductors – BMMN Series

Electrical Characteristics

Part Number	Inductance (uH)	Tolerance (±%)	Test Frequency (kHz)	RDC(mΩ) Max(Typ.)	Isat (A)Typ.	Irms (A)Typ.	Marking
BMMN00050518R47MX2	0.47	20	100	9(7.7)	15.5	10.5	R47
BMMN00050518R56MX2	0.56	20	100	10(8)	15	9.5	R56
BMMN000505181R0MX2	1.0	20	100	17(15)	9	8	1R0
BMMN000505181R2MX2	1.2	20	100	20(17)	8	7.5	1R2
BMMN000505182R2MX2	2.2	20	100	35(30)	6.5	5	2R2
BMMN000505183R3MX2	3.3	20	100	58(52)	5	4.5	3R3
BMMN000505184R7MX2	4.7	20	100	85(78)	4	3.5	4R7
BMMN000505186R8MX2	6.8	20	100	120(107)	3.4	2.8	6R8
BMMN00050518100MX2	10	20	100	155(140)	3	2.5	100

Note: When ordering, please specify tolerance code. Tolerance: M=±20%

- Operating temperature range - 55°C ~ 125°C(Including self - temperature rise)
- Isat for Inductance drop 30% from its value without current
- I rms for a 40°C temperature rise from 25°C ambient with current
- Measure Equipment :
 L : WK 3260B or WK 6500P, 100kHz 0.25V
 RDC : CHEN HWA 502 or CHEN HWA 46502B
 I rms : CHROMA 1810

Test Instruments : WK3260B Impedance / Material Analyzer

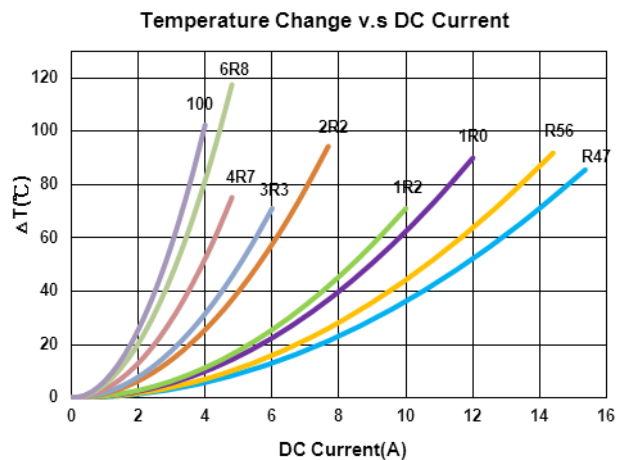
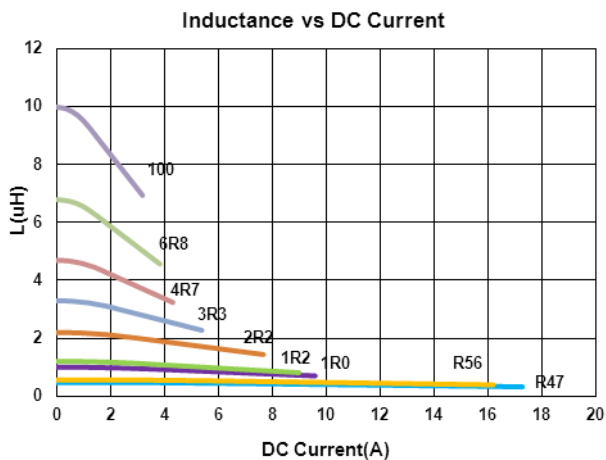

Molding Power Inductors – BMMN Series

Electrical Characteristics

Part Number	Inductance (uH)	Tolerance (±%)	Test Frequency (kHz)	RDC(mΩ) Max(Typ.)	Isat(A) Max(Typ.)	Irms(A) Max(Typ.)	Marking
BMMN000505306R8MX1	6.8	20	100	115(100)	3.2(3.7)	3(3.5)	6R8

Note: When ordering, please specify tolerance code. Tolerance: M=±20%

- Operating temperature range - 55°C ~ 125°C(Including self - temperature rise)
- Isat for Inductance drop 30% from its value without current
- I rms for a 40°C temperature rise from 25°C ambient with current
- Measure Equipment :
 L : WK 3260B or WK 6500P, 100kHz 0.25V
 RDC : CHEN HWA 502 or CHEN HWA 46502B
 I rms : CHROMA 1810

Test Instruments : WK3260B Impedance / Material Analyzer

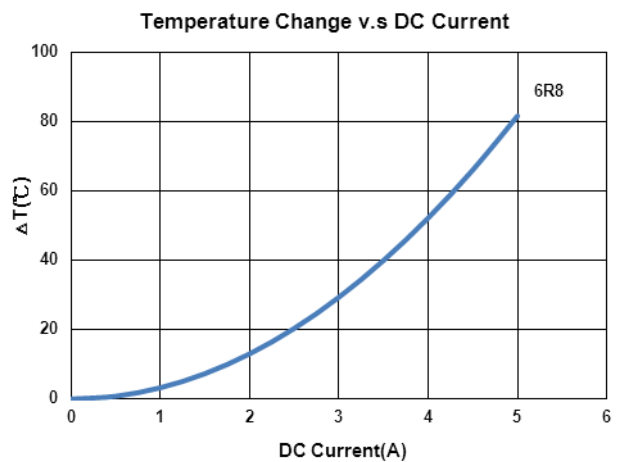
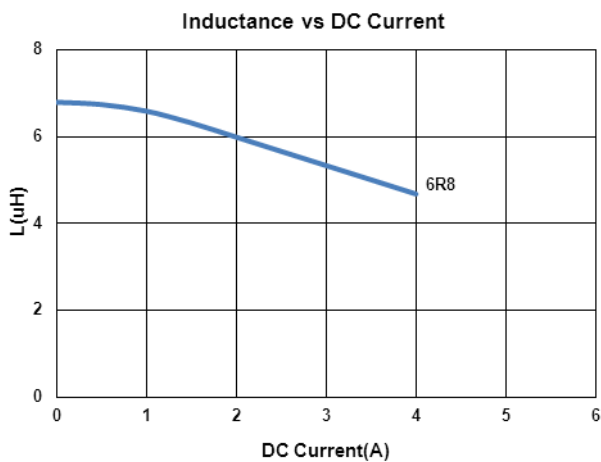

Molding Power Inductors – BMMN Series

Electrical Characteristics

Part Number	Inductance (uH)	Tolerance (±%)	Test Frequency (kHz)	RDC(mΩ) Max(Typ.)	Isat (A)Typ.	Irms (A)Typ.	Marking
BMMN000505306R8MX2	6.8	20	100	100(96)	3	3	6R8

Note: When ordering, please specify tolerance code. Tolerance: M=±20%

- Operating temperature range - 55°C ~ 125°C(Including self - temperature rise)
- Isat for Inductance drop 30% from its value without current
- Irms for a 40°C temperature rise from 25°C ambient with current
- Measure Equipment :
 L : WK 3260B or WK 6500P, 100kHz 0.25V
 RDC : CHEN HWA 502 or CHEN HWA 46502B
 Irms : CHROMA 1810

Test Instruments : WK3260B Impedance / Material Analyzer

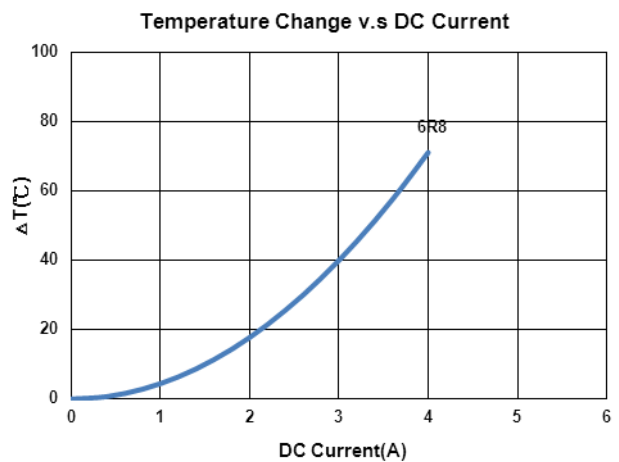
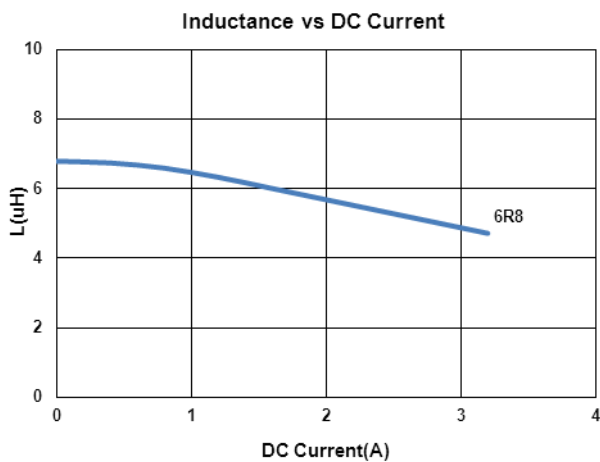

Molding Power Inductors – BMMN Series

Electrical Characteristics

Part Number	Inductance (uH)	Tolerance (±%)	Test Frequency (kHz)	RDC(mΩ) Max(Typ.)	Isat (A)Typ.	Irms (A)Typ.	Marking
BMMN00060615R56MX2	0.56	20	100	11(9.5)	14	9	R56
BMMN00060615R68MX2	0.68	20	100	12(10.5)	12	8.5	R68
BMMN00060615R82MX2	0.82	20	100	17(15)	10	7	R82
BMMN000606151R0MX2	1.0	20	100	21(18.5)	9	5.5	1R0
BMMN000606151R2MX2	1.2	20	100	30(25)	8.5	5.4	1R2
BMMN000606152R2MX2	2.2	20	100	50(43)	6	3.5	2R2
BMMN000606153R3MX2	3.3	20	100	63(54)	5.5	3.3	3R3

Note: When ordering, please specify tolerance code. Tolerance: M=±20%

- Operating temperature range - 55°C ~ 125°C(Including self - temperature rise)
- Isat for Inductance drop 30% from its value without current
- Irms for a 40°C temperature rise from 25°C ambient with current
- Measure Equipment :
 L : WK 3260B or WK 6500P, 100kHz 0.25V
 RDC : CHEN HWA 502 or CHEN HWA 46502B
 Irms : CHROMA 1810

Test Instruments : WK3260B Impedance / Material Analyzer

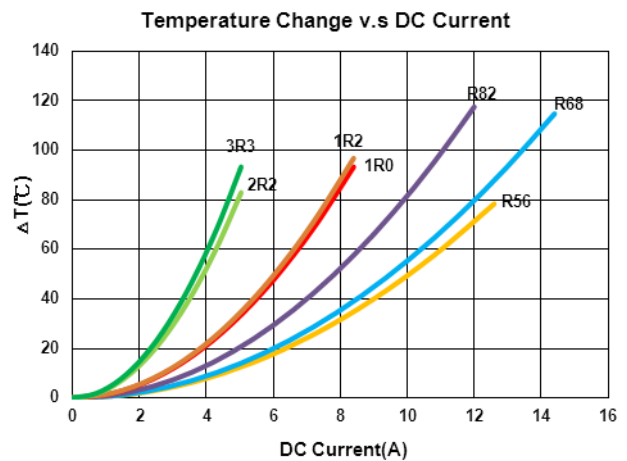
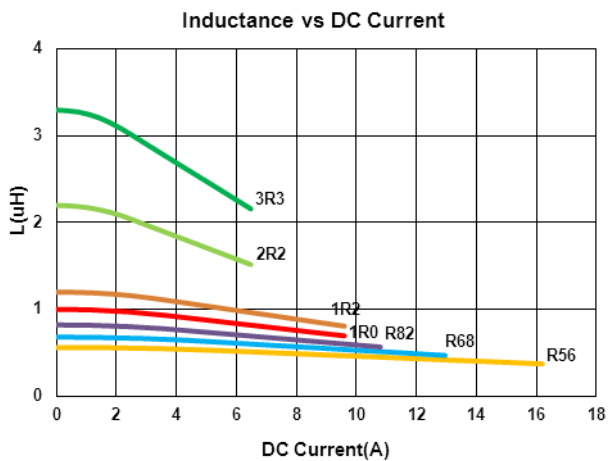

Molding Power Inductors – BMMN Series

Electrical Characteristics

Part Number	Inductance (uH)	Tolerance (±%)	Test Frequency (kHz)	RDC(mΩ) Max(Typ.)	Isat(A) Max(Typ.)	Irms(A) Max(Typ.)	Marking
BMMN00060618R18MX2	0.18	20	100	3.6(3.1)	35(41)	17(20)	R18

Note: When ordering, please specify tolerance code. Tolerance: M=±20%

- Operating temperature range - 55°C ~ 125°C(Including self - temperature rise)
- Isat for Inductance drop 30% from its value without current
- I rms for a 40°C temperature rise from 25°C ambient with current
- Measure Equipment :
 L : WK 3260B or WK 6500P, 100kHz 0.25V
 RDC : CHEN HWA 502 or CHEN HWA 46502B
 I rms : CHROMA 1810

Test Instruments : WK3260B Impedance / Material Analyzer

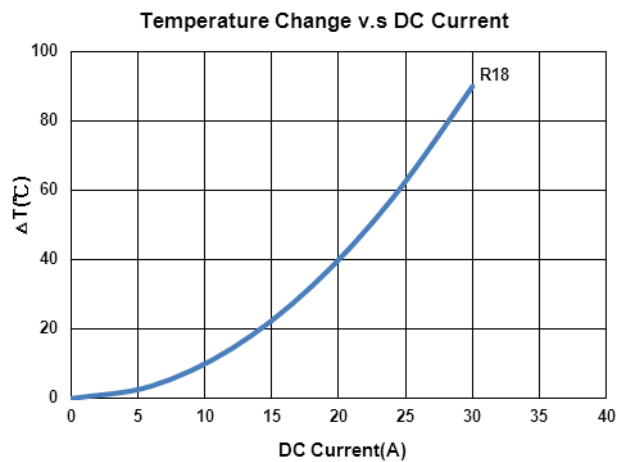
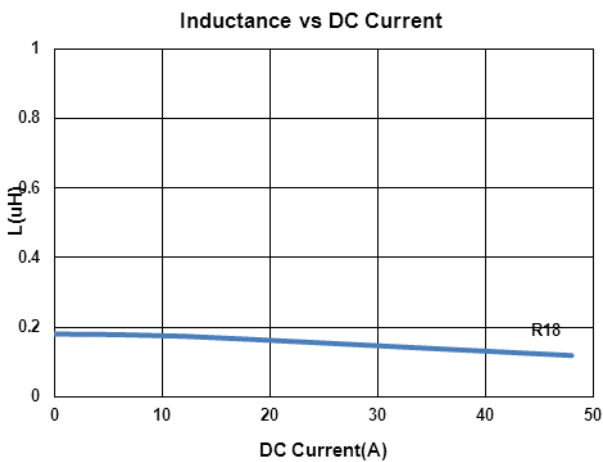

Molding Power Inductors – BMMN Series

Electrical Characteristics

Part Number	Inductance (uH)	Tolerance (±%)	Test Frequency (kHz)	RDC(mΩ) Max(Typ.)	Isat(A) Max(Typ.)	Irms(A) Max(Typ.)	Marking
BMMN000606301R0MX1	1.0	20	100	7.25(6.6)	13.5(16.5)	11.2(13)	1R0
BMMN000606303R3MX1	3.3	20	100	22(17.9)	8.5(9.6)	6.2(7.2)	3R3
BMMN000606304R7MX1	4.7	20	100	33(27.9)	5.5(6.55)	5.5(6.0)	4R7

Note: When ordering, please specify tolerance code. Tolerance: M=±20%

- Operating temperature range - 55°C ~ 125°C(Including self - temperature rise)
- Isat for Inductance drop 30% from its value without current
- I rms for a 40°C temperature rise from 25°C ambient with current
- Measure Equipment :
 L : WK 3260B or WK 6500P, 100kHz 0.25V
 RDC : CHEN HWA 502 or CHEN HWA 46502B
 I rms : CHROMA 1810

Test Instruments : WK3260B Impedance / Material Analyzer

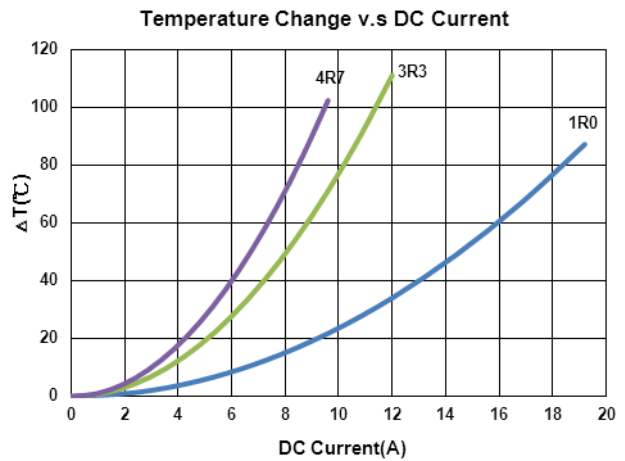
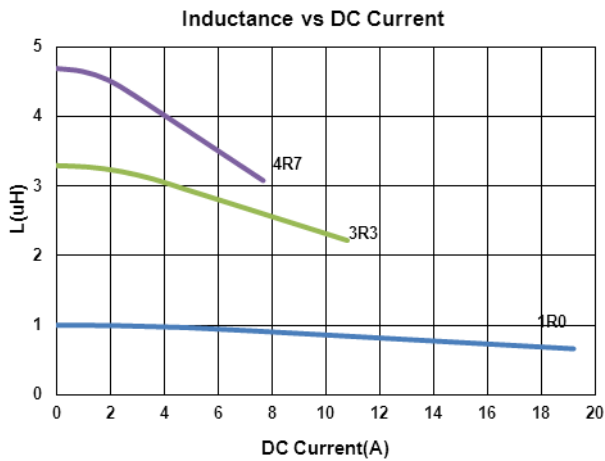

Molding Power Inductors – BMMN Series

Electrical Characteristics

Part Number	Inductance (uH)	Tolerance (±%)	Test Frequency (kHz)	RDC(mΩ) Max(Typ.)	Isat(A) Max(Typ.)	Irms(A) Max(Typ.)	Marking
BMMN001010202R2MX1	2.2	20	100	16.5(14)	11(13)	8.5(10)	2R2

Note: When ordering, please specify tolerance code. Tolerance: M=±20%

- Operating temperature range - 55°C ~ 125°C(Including self - temperature rise)
- Isat for Inductance drop 30% from its value without current
- I rms for a 40°C temperature rise from 25°C ambient with current
- Measure Equipment :
 L : WK 3260B or WK 6500P, 100kHz 0.25V
 RDC : CHEN HWA 502 or CHEN HWA 46502B
 I rms : CHROMA 1810

Test Instruments : WK3260B Impedance / Material Analyzer

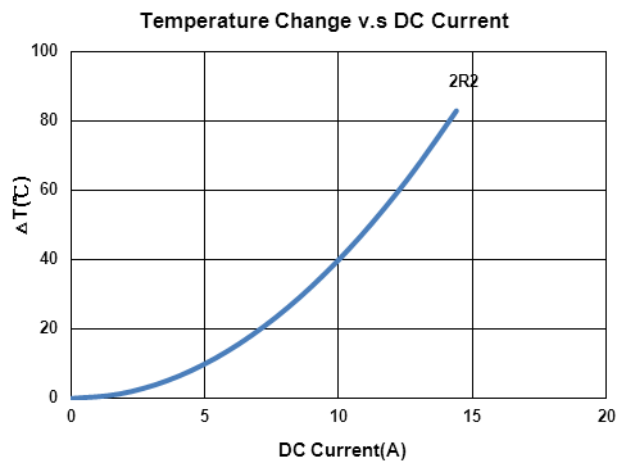
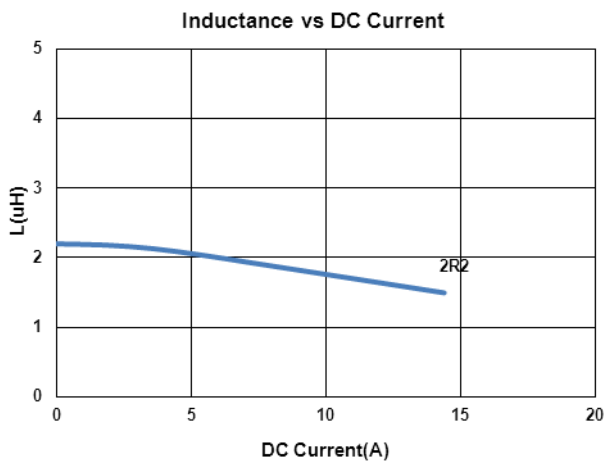

Molding Power Inductors – BMMN Series

Electrical Characteristics

Part Number	Inductance (uH)	Tolerance (±%)	Test Frequency (kHz)	RDC(mΩ) Max(Typ.)	Isat(A) Max(Typ.)	Irms(A) Max(Typ.)	Marking
BMMN001010201R0MX2	1.0	20	100	10.4(9.0)	16(20)	11(12)	1R0

Note: When ordering, please specify tolerance code. Tolerance: M=±20%

- Operating temperature range - 55°C ~ 125°C(Including self - temperature rise)
- Isat for Inductance drop 30% from its value without current
- I rms for a 40°C temperature rise from 25°C ambient with current
- Measure Equipment :
 L : WK 3260B or WK 6500P, 100kHz 0.25V
 RDC : CHEN HWA 502 or CHEN HWA 46502B
 I rms : CHROMA 1810

Test Instruments : WK3260B Impedance / Material Analyzer

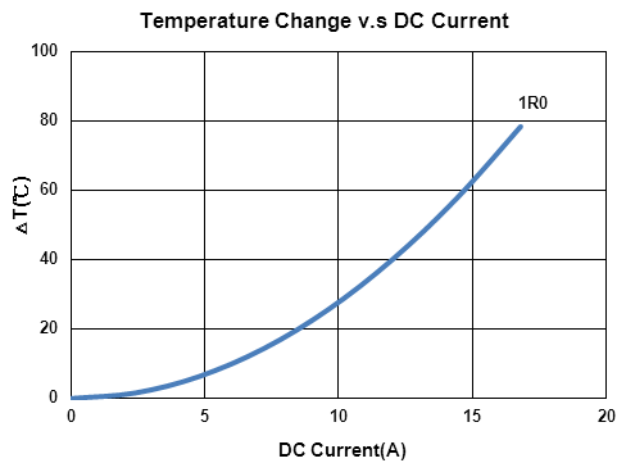
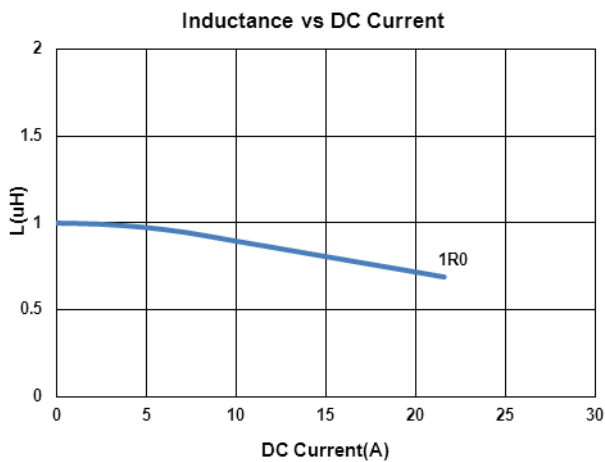

Molding Power Inductors – BMMN Series

Electrical Characteristics

Part Number	Inductance (uH)	Tolerance (±%)	Test Frequency (kHz)	RDC(mΩ) Max(Typ.)	Isat(A) Max(Typ.)	Irms(A) Max(Typ.)	Marking
BMMN001010301R2MX1	1.2	20	100	15.2(12.5)	20(24)	9.5(10.5)	1R2

Note: When ordering, please specify tolerance code. Tolerance: M=±20%

- Operating temperature range - 55°C ~ 125°C(Including self - temperature rise)
- Isat for Inductance drop 30% from its value without current
- I rms for a 40°C temperature rise from 25°C ambient with current
- Measure Equipment :
 L : WK 3260B or WK 6500P, 100kHz 0.25V
 RDC : CHEN HWA 502 or CHEN HWA 46502B
 I rms : CHROMA 1810

Test Instruments : WK3260B Impedance / Material Analyzer

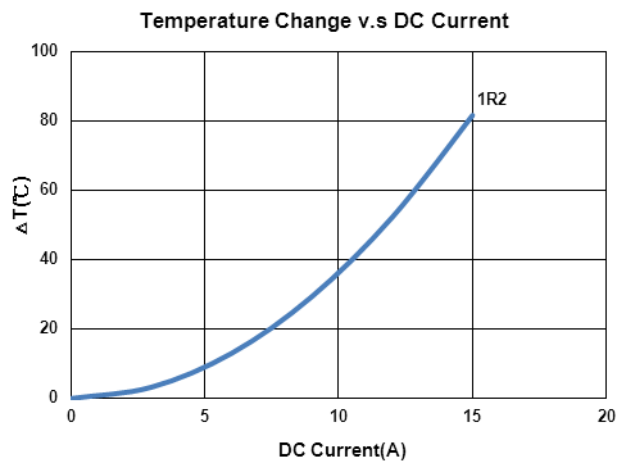
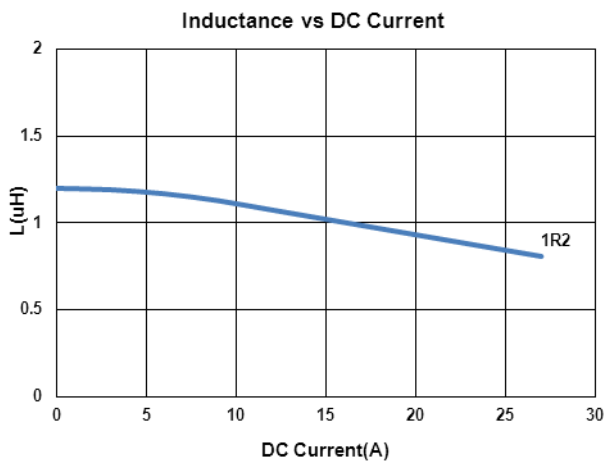

Molding Power Inductors – BMMN Series

Electrical Characteristics

Part Number	Inductance (uH)	Tolerance (±%)	Test Frequency (kHz)	RDC(mΩ) Max(Typ.)	Isat (A)Typ.	Irms (A)Typ.	Marking
BMMN00101030220MX2	22	20	100	99(90)	5.0	3.0	220

Note: When ordering, please specify tolerance code. Tolerance: M=±20%

- Operating temperature range - 55°C ~ 125°C(Including self - temperature rise)
- Isat for Inductance drop 30% from its value without current
- Irms for a 40°C temperature rise from 25°C ambient with current
- Measure Equipment :
 L : WK 3260B or WK 6500P, 100kHz 0.25V
 RDC : CHEN HWA 502 or CHEN HWA 46502B
 Irms : CHROMA 1810

Test Instruments : WK3260B Impedance / Material Analyzer

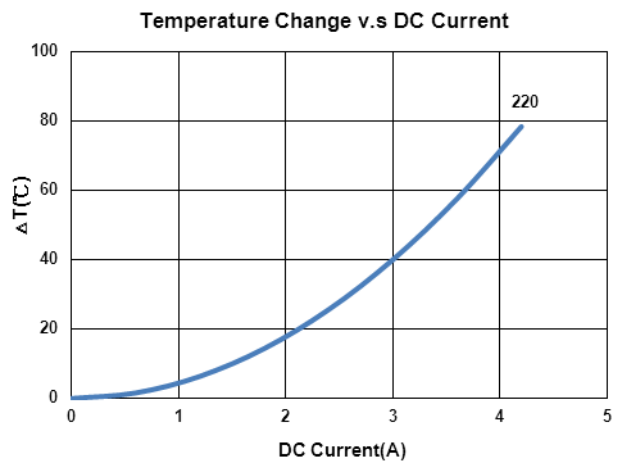
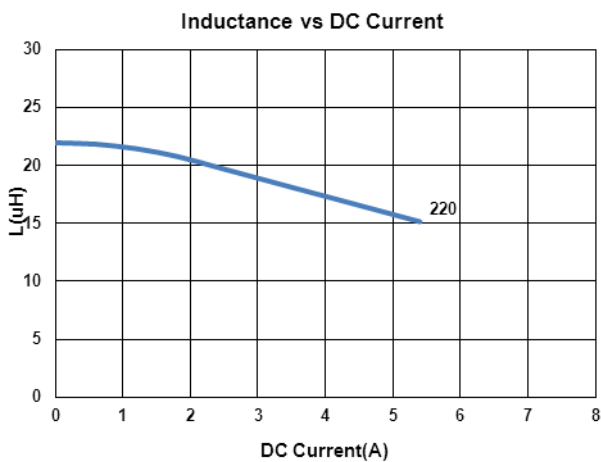

Molding Power Inductors – BMMN Series

Electrical Characteristics

Part Number	Inductance (uH)	Tolerance (±%)	Test Frequency (kHz)	RDC(mΩ) Max(Typ.)	Isat(A) Max(Typ.)	Irms(A) Max(Typ.)	Marking
BMMN001010402R2MX1	2.2	20	100	7(6)	16(20)	11(12)	2R2
BMMN001010403R3MX1	3.3	20	100	12(10.5)	14(16.2)	9(10)	3R3

Note: When ordering, please specify tolerance code. Tolerance: M=±20%

- Operating temperature range - 55°C ~ 125°C(Including self - temperature rise)
- Isat for Inductance drop 30% from its value without current
- I rms for a 40°C temperature rise from 25°C ambient with current
- Measure Equipment :
 L : WK 3260B or WK 6500P, 100kHz 0.25V
 RDC : CHEN HWA 502 or CHEN HWA 46502B
 I rms : CHROMA 1810

Test Instruments : WK3260B Impedance / Material Analyzer

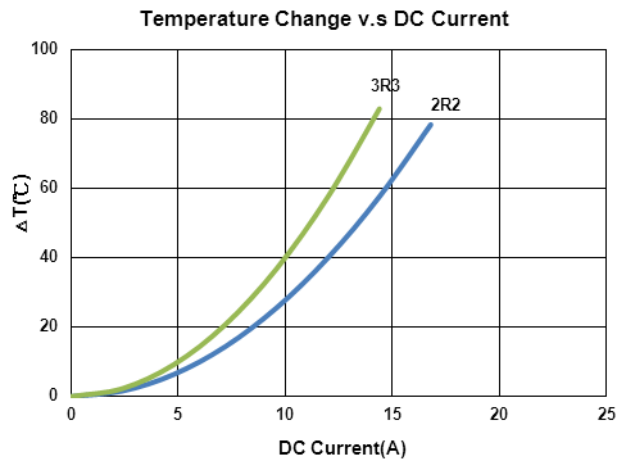
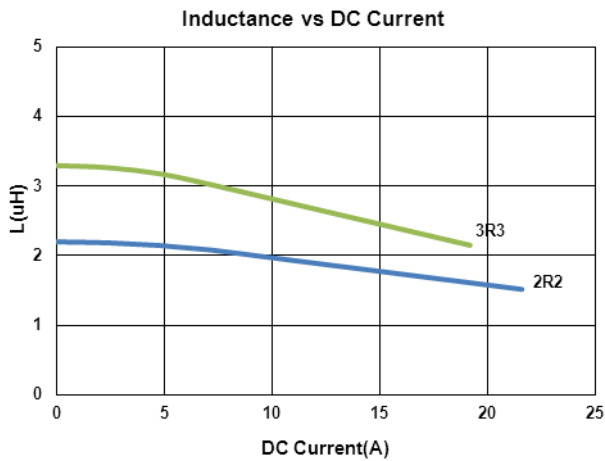

Molding Power Inductors – BMMN Series

Electrical Characteristics

Part Number	Inductance (uH)	Tolerance (±%)	Test Frequency (kHz)	RDC(mΩ) Max(Typ.)	Isat (A)Typ.	Irms (A)Typ.	Marking
BMMN00101040220MX2	22	20	100	66(60)	5.5	5.0	220
BMMN00101040330MX2	33	20	100	92(85)	5.0	4.4	330
BMMN00101040470MX2	47	20	100	145(130)	3.5	3.3	470

Note: When ordering, please specify tolerance code. Tolerance: M=±20%

- Operating temperature range - 55°C ~ 125°C(Including self - temperature rise)
- Isat for Inductance drop 30% from its value without current
- Irms for a 40°C temperature rise from 25°C ambient with current
- Measure Equipment :
 L : WK 3260B or WK 6500P, 100kHz 0.25V
 RDC : CHEN HWA 502 or CHEN HWA 46502B
 Irms : CHROMA 1810

Test Instruments : WK3260B Impedance / Material Analyzer

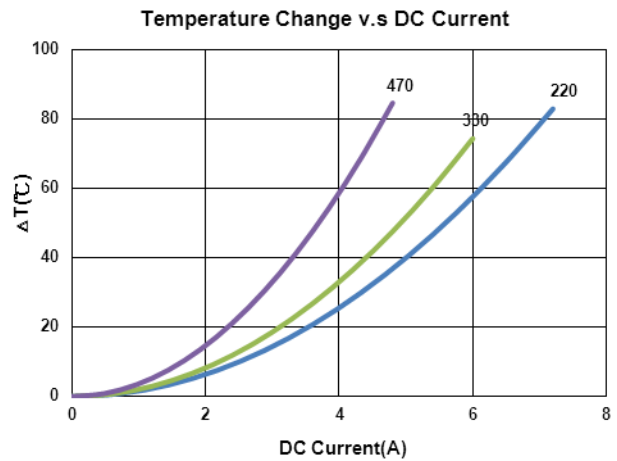
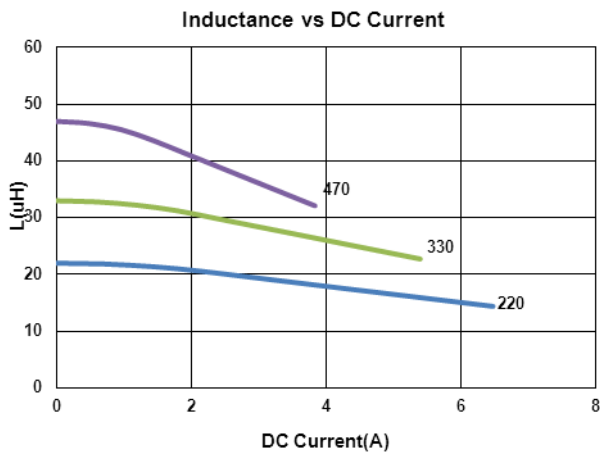

Molding Power Inductors – BMMN Series

Electrical Characteristics

Part Number	Inductance (uH)	Tolerance (±%)	Test Frequency (kHz)	RDC(mΩ) Max(Typ.)	Isat(A) Max(Typ.)	Irms(A) Max(Typ.)	Marking
BMMN00131350R82MX1	0.82	20	100	2.0(1.7)	55(65)	28(31)	R82
BMMN001313501R0MX1	1.0	20	100	2.5(2.05)	50(58)	26(29)	1R0
BMMN001313502R2MX1	2.2	20	100	5.2(4.5)	32(36)	19(20)	2R2
BMMN001313503R3MX1	3.3	20	100	8.6(7.5)	28(33)	14(15)	3R3

Note: When ordering, please specify tolerance code. Tolerance: M=±20%

- Operating temperature range - 55°C ~ 125°C(Including self - temperature rise)
- Isat for Inductance drop 30% from its value without current
- Irms for a 40°C temperature rise from 25°C ambient with current
- Measure Equipment :
 L : WK 3260B or WK 6500P, 100kHz 0.25V
 RDC : CHEN HWA 502 or CHEN HWA 46502B
 Irms : CHROMA 1810

Test Instruments : WK3260B Impedance / Material Analyzer

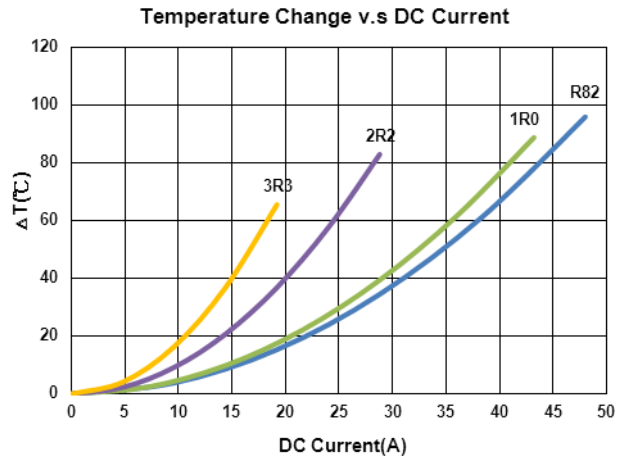
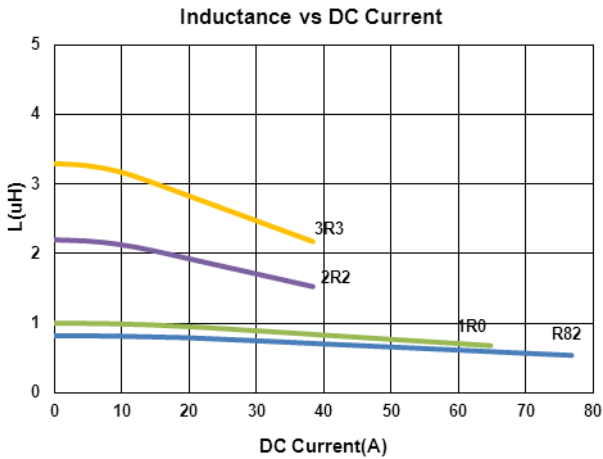

Molding Power Inductors – BMMN Series

Electrical Characteristics

Part Number	Inductance (uH)	Tolerance (±%)	Test Frequency (kHz)	RDC(mΩ) Max(Typ.)	Isat (A)Typ.	Irms (A)Typ.	Marking
BMMN00131360100MX2	10	20	100	20.7(18)	12.5	10	100
BMMN00131360180MX2	18	20	100	35(30)	8	5	180

Note: When ordering, please specify tolerance code. Tolerance: M=±20%

- Operating temperature range - 55°C ~ 125°C(Including self - temperature rise)
- Isat for Inductance drop 30% from its value without current
- Irms for a 40°C temperature rise from 25°C ambient with current
- Measure Equipment :
 L : WK 3260B or WK 6500P, 100kHz 0.25V
 RDC : CHEN HWA 502 or CHEN HWA 46502B
 Irms : CHROMA 1810

Test Instruments : WK3260B Impedance / Material Analyzer

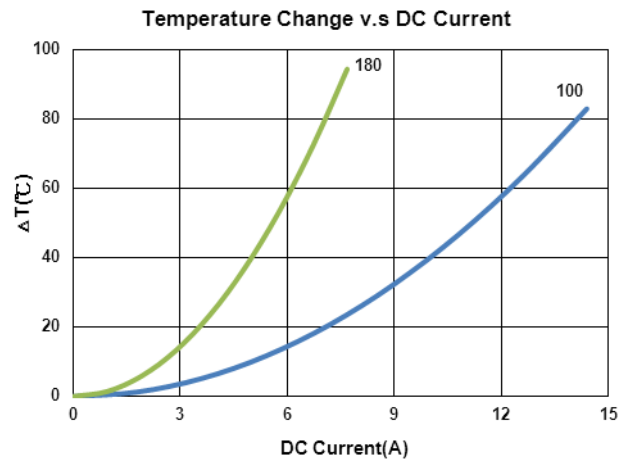
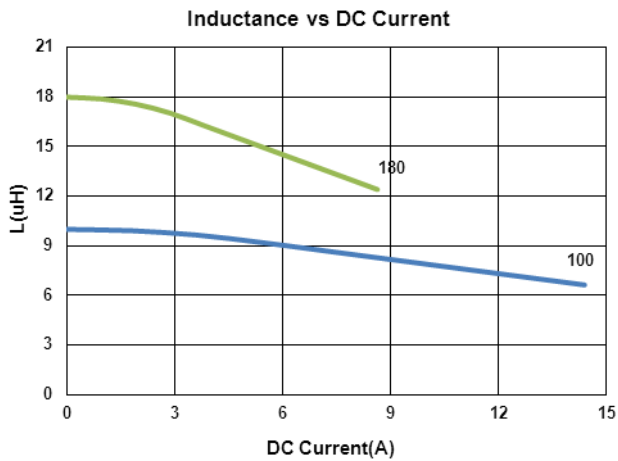

Molding Power Inductors – BMMN Series

Electrical Characteristics

Part Number	Inductance (uH)	Tolerance (±%)	Test Frequency (kHz)	RDC(mΩ) Max(Typ.)	Isat (A)Typ.	Irms (A)Typ.	Marking
BMMN001313651R0MX2	1.0	20	100	2.3(1.9)	50	28	1R0

Note: When ordering, please specify tolerance code. Tolerance: M=±20%

- Operating temperature range - 55°C ~ 125°C(Including self - temperature rise)
- Isat for Inductance drop 30% from its value without current
- Irms for a 40°C temperature rise from 25°C ambient with current
- Measure Equipment :
 L : WK 3260B or WK 6500P, 100kHz 0.25V
 RDC : CHEN HWA 502 or CHEN HWA 46502B
 Irms : CHROMA 1810

Test Instruments : WK3260B Impedance / Material Analyzer

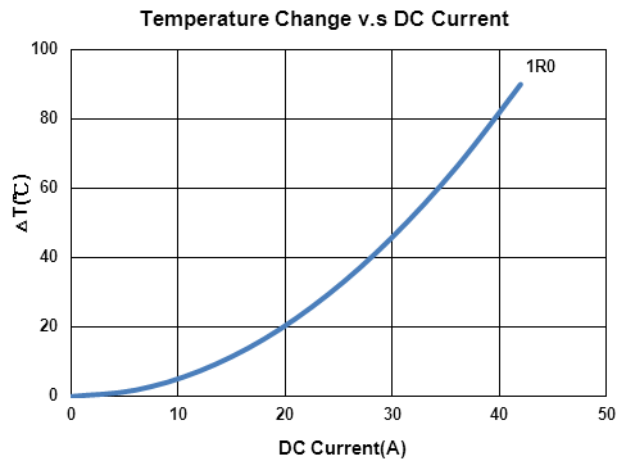
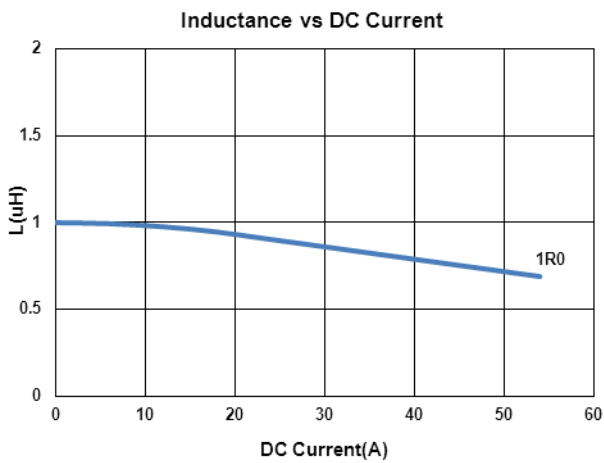

Molding Power Inductors – BMMN Series

Electrical Characteristics

Part Number	Inductance (uH)	Tolerance (±%)	Test Frequency (kHz)	RDC(mΩ) Max(Typ.)	Isat(A) Max(Typ.)	Irms(A) Max(Typ.)	Marking
BMMN001717702R2MX1	2.2	20	100	2.5(2.1)	33(38)	30(37)	2R2
BMMN001717706R8MX1	6.8	20	100	7.5(6.5)	22(25)	19(21)	6R8

Note: When ordering, please specify tolerance code. Tolerance: M=±20%

- Operating temperature range - 55°C ~ 125°C(Including self - temperature rise)
- Isat for Inductance drop 30% from its value without current
- I rms for a 40°C temperature rise from 25°C ambient with current
- Measure Equipment :
 L : WK 3260B or WK 6500P, 100kHz 0.25V
 RDC : CHEN HWA 502 or CHEN HWA 46502B
 I rms : CHROMA 1810

Test Instruments : WK3260B Impedance / Material Analyzer

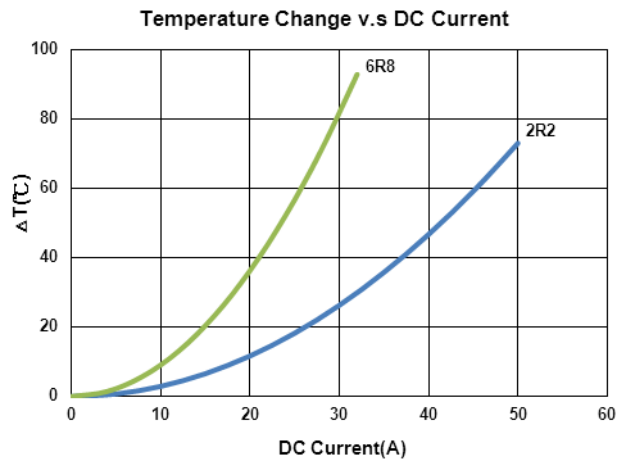
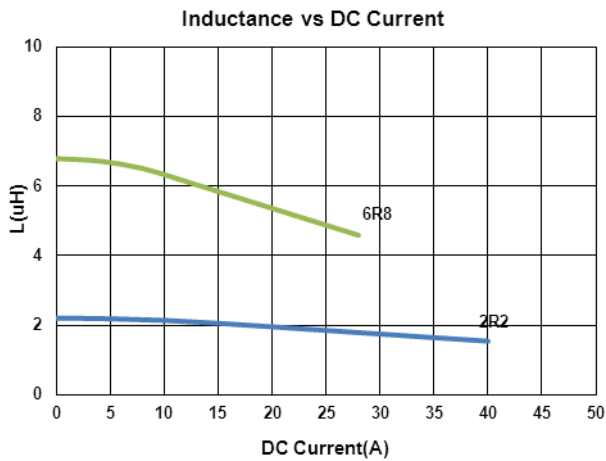

Molding Power Inductors – BMMN Series

Electrical Characteristics

Part Number	Inductance (uH)	Tolerance (±%)	Test Frequency (kHz)	RDC(mΩ) Max(Typ.)	Isat (A)Typ.	Irms (A)Typ.	Marking
BMMN00171770100MX2	10	20	100	10(9.3)	18	14	100

Note: When ordering, please specify tolerance code. Tolerance: M=±20%

- Operating temperature range - 55°C ~ 125°C(Including self - temperature rise)
- Isat for Inductance drop 30% from its value without current
- I rms for a 40°C temperature rise from 25°C ambient with current
- Measure Equipment :
 L : WK 3260B or WK 6500P, 100kHz 0.25V
 RDC : CHEN HWA 502 or CHEN HWA 46502B
 I rms : CHROMA 1810

Test Instruments : WK3260B Impedance / Material Analyzer

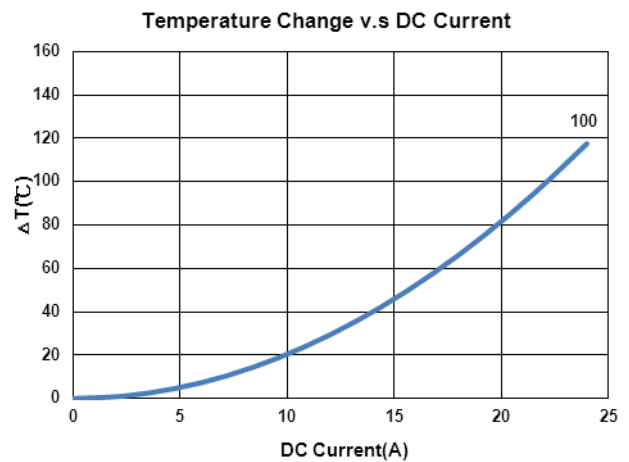
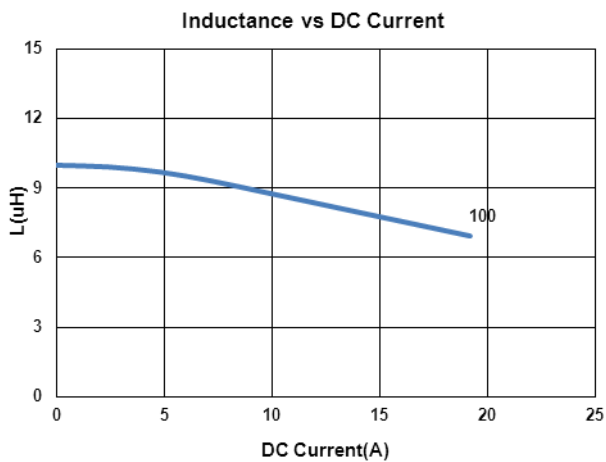

Packaging Specifications

Tape Dimensions

Reel Dimensions

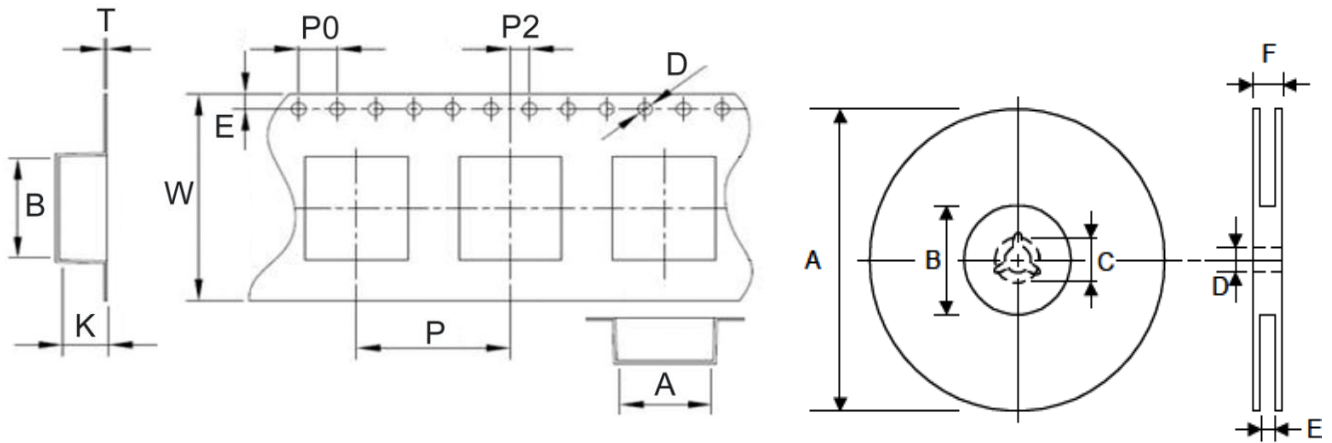

Dimensions in mm

TYPE	Tape Dimensions										Reel Dimensions						Quantity PCS / REEL
	A	B	K	T	D	E	W	P	P0	P2	A	B	C	D	E	F	
BMMN00040412	4.5	4.9	1.7	0.35	1.5	1.75	12	8	4	2	330	100	21.5	13	12.4	17.4	2000
BMMN00040420	4.5	4.9	2.4	0.35	1.5	1.75	12	8	4	2	330	100	21.5	13	12.4	17.4	2000
BMMN00050512	5.4	5.8	1.4	0.3	1.5	1.75	12	8	4	2	330	100	21.5	13	12.4	17.4	1000
BMMN00050515	5.4	5.8	1.95	0.3	1.5	1.75	12	8	4	2	330	100	21.5	13	12.4	17.4	1000
BMMN00050518	5.4	5.8	1.95	0.3	1.5	1.75	12	8	4	2	330	100	21.5	13	12.4	17.4	1000
BMMN00050530	5.0	5.4	3.2	0.35	1.5	1.75	12	8	4	2	330	100	21.5	13	12.4	17.4	1000
BMMN00060615	6.9	7.5	2.1	0.3	1.5	1.75	16	12	4	2	330	100	21.5	13	16.4	21.4	1000
BMMN00060618	6.9	7.5	2.1	0.3	1.5	1.75	16	12	4	2	330	100	21.5	13	16.4	21.4	1000
BMMN00060630	6.9	7.6	3.4	0.35	1.5	1.75	16	12	4	2	330	100	21.5	13	16.4	21.4	1000
BMMN00101020	10.4	11.5	2.8	0.35	1.5	1.75	24	16	4	2	330	100	21.5	13	24.2	29.2	500
BMMN00101030	10.4	11.5	3.4	0.35	1.5	1.75	24	16	4	2	330	100	21.5	13	24.2	29.2	500
BMMN00101040	10.4	11.5	4.5	0.35	1.5	1.75	24	16	4	2	330	100	21.5	13	24.2	29.2	500
BMMN00131350	13.4	14	5.4	0.4	1.5	1.75	24	16	4	2	330	100	21.5	13	24.2	29.2	250
BMMN00131360	13.2	14.4	6.3	0.4	1.5	1.75	24	16	4	2	330	100	21.5	13	24.2	29.2	250
BMMN00131365	13.4	14.1	6.8	0.4	1.5	1.75	24	16	4	2	330	100	21.5	13	24.2	29.2	250
BMMN00171770	17.45	18.5	7.8	0.5	1.5	1.75	32	24	4	2	330	100	21.5	13	32	37	100

单击下面可查看定价，库存，交付和生命周期等信息

[>>CHILISIN\(奇力新\)](#)