

BPSS Series

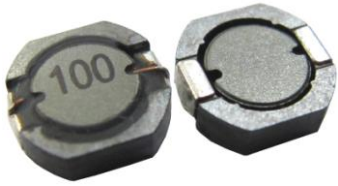

The BPSS Series is designed for low profile type with low RDC and large current. The magnetic shielding supports high – density mounting. This series also provides working – frequency up to 1MHz.

Features

- RoHS compliant
- Low Rdc and high saturation current for portable DC to DC converter line
- High magnetic shielding construction provides high resolution for EMC protection
- Support lead-free soldering

Applications

- Notebook PC
- Set top box
- LCD TV
- LCD displays
- Portable communication device
- DC/DC converters

Product Identification

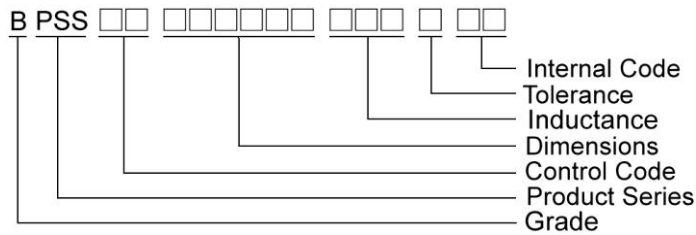

Shape and Dimensions

FIG 1

FIG 2

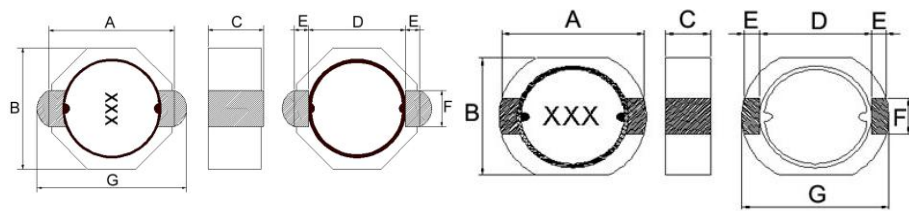

Recommended Pattern

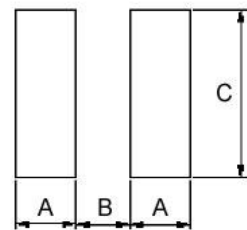

Dimensions in mm

TYPE	Shape and Dimensions								Recommended Pattern		
	FIG	A	B	C	D	E	F	G	A	B	C
BPSS00050522	1	5.2±0.3	5.0±0.3	2.2Max	4.0	0.6	1.5	6.2Max	1.5	3.2	1.5
BPSS00080725	2	7.5±0.3	7.4±0.3	2.5Max	5.6	1.2	2.5	8.7Max	1.5	5.4	2.8
BPSS00080740	2	7.5±0.3	7.4±0.3	4.0Max	5.6	1.2	2.5	9.2Max	1.5	5.4	2.8

SMD Shielded Power Inductors – BPSS Series

Standard Specifications

Part Number	Inductance (uH)	Tolerance (±%)	Test Frequency (kHz)	RDC (mΩ) Max	Isat (A)	Irms (A)
BPSS000505221R2□00	1.2	30	100	25	4.3	3.43
BPSS000505221R8□00	1.8	30	100	32	3.6	3.12
BPSS000505223R3□00	3.3	30	100	54	2.5	2.68
BPSS000505224R7□00	4.7	30	100	81	2.0	2.18
BPSS00050522100□00	10	20,30	100	160	1.4	1.51
BPSS00050522220□00	22	20,30	100	320	0.9	1.02
BPSS00050522330□00	33	20,30	100	490	0.77	0.80

Note: When ordering, please specify tolerance code. Tolerance: M=±20% , T=±30%

- Operating temperature range - 40°C ~ 105°C(Including self - temperature rise)
- Isat for Inductance drop 30% from its value without current
- I rms for a 40°C temperature rise from 25°C ambient with current
- Measure Equipment :
 L : HP4284A.+Aglient 16334A , 100kHz/ 1V
 RDC : Chroma 16502
 Isat : HP4284A+HP42841A or WK3260B+WK3265B
 I rms : Agilent 6641 SYSTEM DC POWER SUPPLY

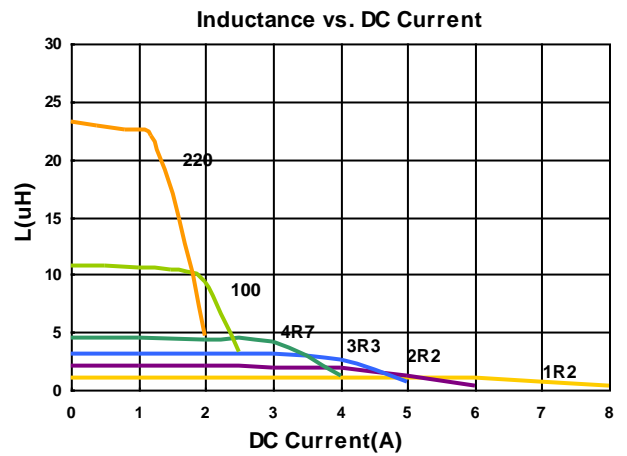
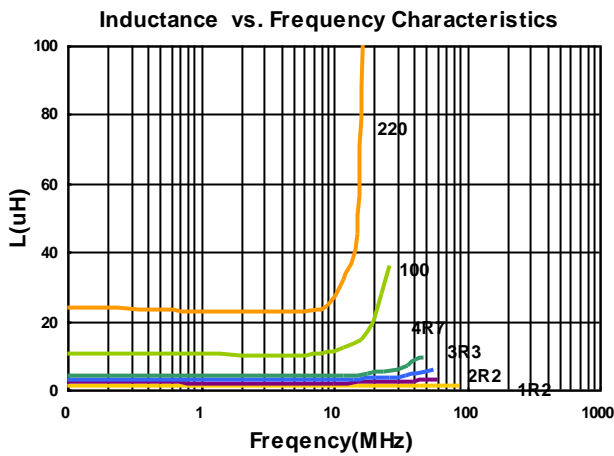

SMD Shielded Power Inductors – BPSS Series

Standard Specifications

Part Number	Inductance (uH)	Tolerance (±%)	Test Frequency (kHz)	RDC (mΩ) Max	Isat (A)	Irms (A)
BPSS000807251R0□00	1.0	30	100	14.28	8.3	6.22
BPSS000807251R5□00	1.5	30	100	19.70	7.2	5.00
BPSS000807252R2□00	2.2	30	100	24.09	5.4	4.40
BPSS000807253R3□00	3.3	30	100	41.20	4.4	3.70
BPSS000807254R7□00	4.7	30	100	49.70	4.0	3.20
BPSS000807255R6□00	5.6	20,30	100	58.90	3.9	2.90
BPSS000807256R8□00	6.8	20,30	100	66.30	3.5	2.70
BPSS00080725100□00	10	20,30	100	92.40	2.8	1.90
BPSS00080725150□00	15	20,30	100	170.0	2.3	1.70
BPSS00080725220□00	22	20,30	100	210.0	1.5	1.52
BPSS00080725330□00	33	20,30	100	320.0	1.4	1.10
BPSS00080725470□00	47	20,30	100	490.0	1.2	0.95

Note: When ordering, please specify tolerance code. Tolerance: M=±20% , T=±30%

- Operating temperature range - 40°C ~ 105°C(Including self - temperature rise)
- Isat for Inductance drop 30% from its value without current
- Irms for a 40°C temperature rise from 25°C ambient with current
- Measure Equipment :
 L : HP4284A.+Aglient 16334A , 100kHz/ 1V
 RDC : Chroma 16502
 Isat : HP4284A+HP42841A or WK3260B+WK3265B
 Irms : Agilent 6641 SYSTEM DC POWER SUPPLY

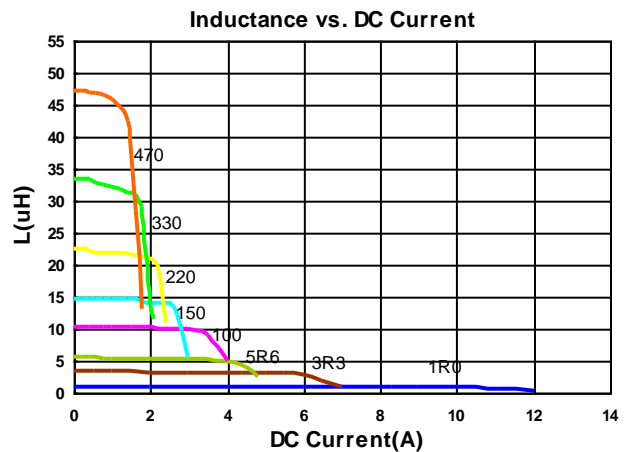
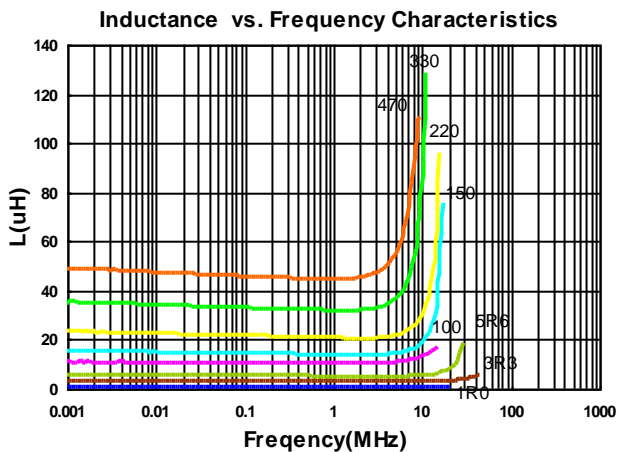

Please be sure to request approval specifications that provide further details of the products. Kindly note that the content of these specifications are subject to change or may be discontinued without prior notice. This product may not be designed/used in medical or high risk applications without Chilisin approval. Please contact our sales department before ordering.

SMD Shielded Power Inductors – BPSS Series

Standard Specifications

Part Number	Inductance (uH)	Tolerance (±%)	Test Frequency (kHz)	RDC (mΩ) Max	Isat(A) Max(Typ)	Irms (A)
BPSS000807401R0□00	1.0	30	100	6.38	(8.0)12	9.00
BPSS000807401R5□00	1.5	30	100	8.64	(7.0)10	8.00
BPSS000807401R8□00	1.8	30	100	9.60	(6.5)8.6	7.92
BPSS000807402R5□00	2.5	30	100	13.6	(4.8)7.2	7.40
BPSS000807403R3□00	3.3	30	100	17.8	(3.9)6.8	6.70
BPSS000807404R7□00	4.7	20,30	100	26.6	(3.5)4.6	4.90
BPSS000807405R6□00	5.6	20,30	100	29.0	(3.3)4.1	4.60
BPSS000807406R8□00	6.8	20,30	100	34.0	(3.2)3.9	3.90
BPSS00080740100□00	10	20,30	100	55.6	(2.5)3.4	3.25
BPSS00080740150□00	15	20,30	100	74.4	(2.1)3.0	2.70
BPSS00080740220□00	22	20,30	100	98.1	(1.7)2.4	2.40
BPSS00080740330□00	33	20,30	100	140	(1.4)2.0	1.90
BPSS00080740470□00	47	20,30	100	217	(1.2)1.7	1.48
BPSS00080740560□00	56	20,30	100	260	(1.0)1.5	1.33
BPSS00080740680□00	68	20,30	100	310	(0.95)1.36	1.20
BPSS00080740820□00	82	20,30	100	360	(0.9)1.20	1.12
BPSS00080740101□00	100	20,30	100	480	(0.85)1.12	0.95
BPSS00080740121□00	120	20,30	100	560	(0.75)1.00	0.89
BPSS00080740151□00	150	20,30	100	710	(0.65)0.92	0.82

Note: When ordering, please specify tolerance code. Tolerance: M=±20% , T=±30%

- Operating temperature range - 40°C ~ 105°C(Including self - temperature rise)
- Isat for Inductance drop 30% from its value without current
- I rms for a 40°C temperature rise from 25°C ambient with current
- Measure Equipment :
 L : HP4284A.+Aglient 16334A , 100kHz/ 1V
 RDC : Chroma 16502
 Isat : HP4284A+HP42841A or WK3260B+WK3265B
 I rms : Agilent 6641 SYSTEM DC POWER SUPPLY

Inductance vs. Frequency Characteristics

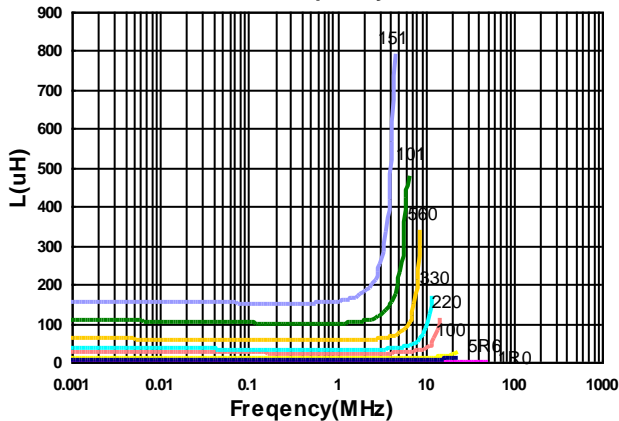

Inductance vs. DC Current

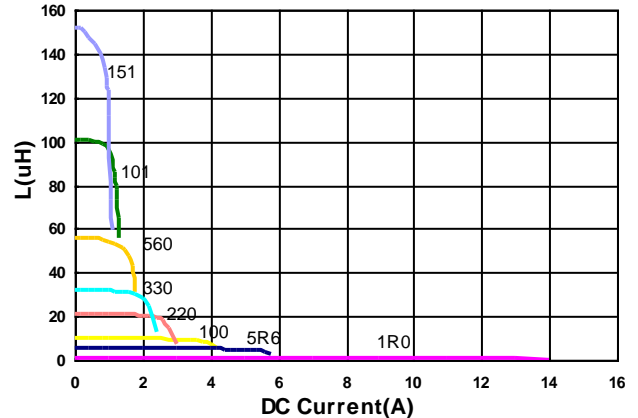

Please be sure to request approval specifications that provide further details of the products. Kindly note that the content of these specifications are subject to change or may be discontinued without prior notice. This product may not be designed/used in medical or high risk applications without Chilisin approval. Please contact our sales department before ordering.

SMD Shielded Power Inductors – BPSS Series

Packaging Specifications

Tape Dimensions

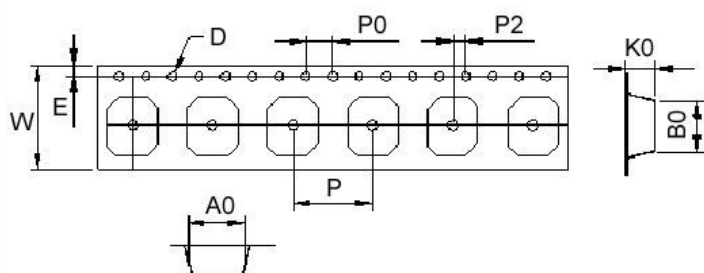

Tape Material

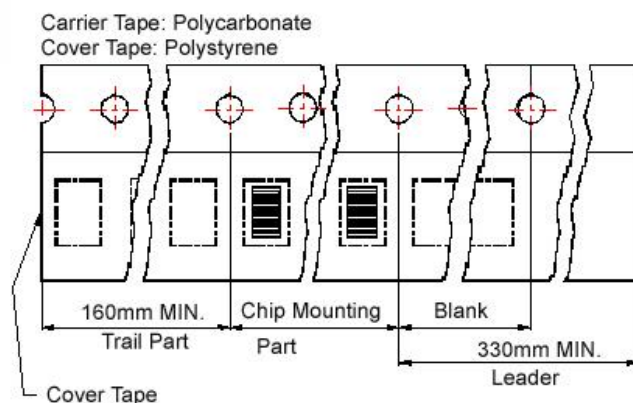

Reel Dimensions

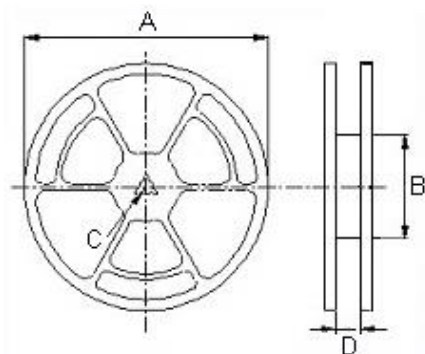

Dimensions in mm

TYPE	Tape Dimensions									Reel Dimensions				Quantity PCS / REEL
	A0	B0	K0	D	E	W	P	P0	P2	A	B	C	D	
BPSS00050522	5.25	6.25	2.4	1.55	1.75	12	8	4	2	330	100	13	13.4	2000
BPSS00080725	7.6	8.65	2.8	1.55	1.75	16	12	4	2	330	100	13	16	1500
BPSS00080740	7.6	9.0	4.3	1.55	1.75	16	12	4	2	330	100	13	16	1000

单击下面可查看定价，库存，交付和生命周期等信息

[>>CHILISIN\(奇力新\)](#)