

## BWVH Series



BWVH series, an automatic assembly constructed power inductor, is shielded with magnetic resin and suitable for portable DC-DC converter applications.

### Features

- RoHS, Halogen Free and REACH Compliance
- Shielded with magnetic resin
- Low profile, miniature package size and wide inductance range.
- Low DCR and high rated current.

### Applications

- Smart phone
- DSC
- Tablet PC and other portable devices
- DC/DC converters

### Product Identification

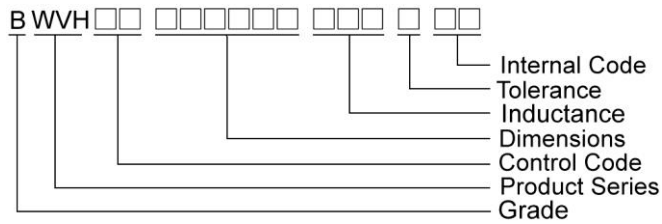

### Shape and Dimensions

Figure 1

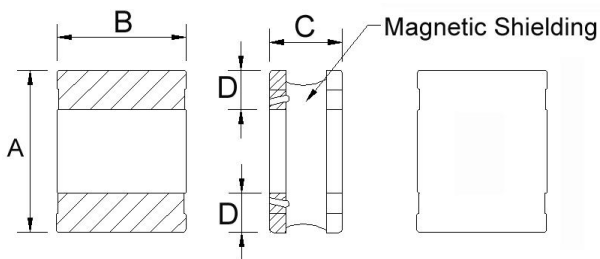

### Recommended Pattern

Figure 2

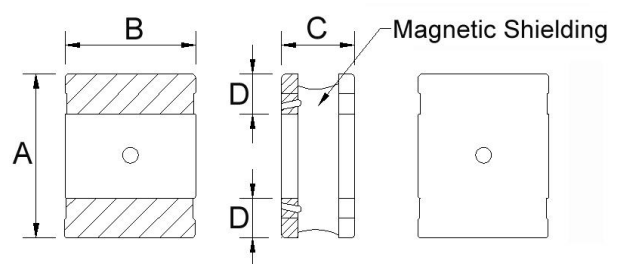

### Recommended Pattern

Dimensions in mm

TYPE	FIG	A	B	C	D	H	I	J
BWVH00201610_H1	1	2.0±0.25	1.6±0.25	1.02 Max	0.6	1.8	0.8	0.8
BWVH00252010_H1	1	2.5±0.25	2.0±0.25	1.00 Max	0.8	2.2	0.85	0.8
BWVH00252012_H1	2	2.5±0.25	2.0±0.25	1.2±0.05	0.8	2.2	0.85	0.8

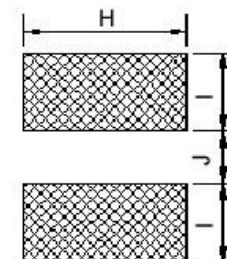

# Sealed Power Inductors – BWVH Series

## Shape and Dimensions

## Recommended Pattern

Figure 3

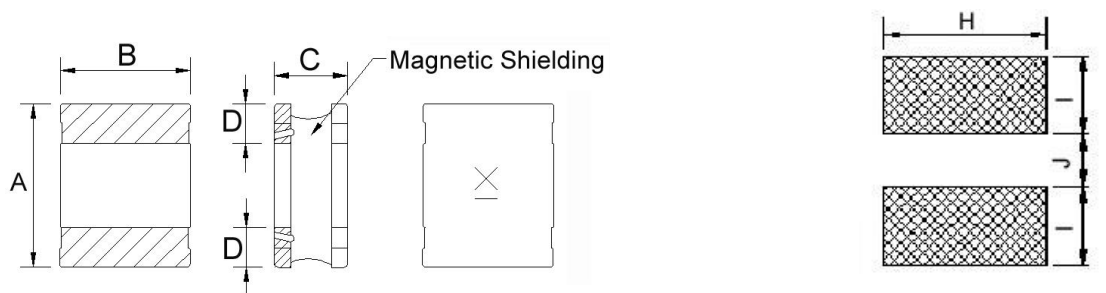

Dimensions in mm

TYPE	FIG	A	B	C	D	H	I	J
BWVH00252012	3	2.5±0.25	2.0±0.25	1.2±0.05	0.8	2.2	0.85	0.8

Figure 4

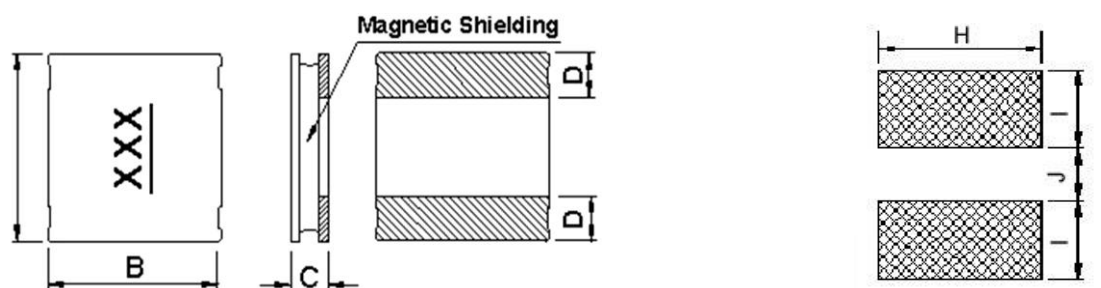

Dimensions in mm

TYPE	FIG	A	B	C	D	H	I	J
BWVH00595610	4	5.9±0.20	5.6±0.20	1.00 Max	1.4	5.8	1.5	3.2

## Electrical Characteristics

Part Number	Inductance (uH)	Tolerance (±%)	Test Frequency (MHz)	RDC (Ω) ±30%	Isat (mA) Typ. (Max)	Irms (mA) Typ. (Max)
BWVH00201610R24□H1	0.24	20, 30	1	0.048	3700(3300)	2500(2100)
BWVH00201610R33□H1	0.33	20, 30	1	0.048	3400(3000)	2500(2100)
BWVH00201610R47□H1	0.47	20, 30	1	0.072	2900(2600)	2100(1800)
BWVH00201610R56□H1	0.56	20, 30	1	0.072	2700(2400)	2100(1800)
BWVH00201610R68□H1	0.68	20, 30	1	0.092	2500(2200)	1800(1500)
BWVH002016101R0□H1	1.0	20, 30	1	0.110	2200(2000)	1500(1200)
BWVH002016102R2□H1	2.2	20, 30	1	0.205	1400(1200)	1150(970)
BWVH002016103R3□H1	3.3	20, 30	1	0.380	1050(940)	900(800)
BWVH002016104R7□H1	4.7	20, 30	1	0.520	900(800)	800(680)
BWVH00201610100□H1	10	20, 30	1	1.100	620(550)	450(380)

**Note:** When ordering, please specify tolerance code. Tolerance: M=±20% , T =±30%

- Operating temperature range - 55°C ~ 125°C(Including self - temperature rise)
- Isat for Inductance drop 30% from its value without current
- I rms for a 40°C temperature rise from 25°C ambient with current
- Measure Equipment :
- L : Agilent HP4287A+Agilent HP16197A, 1MHz 200mV
- RDC : DIGITAL MILLINHM METER CHROMA 16502, or equivalent
- Isat & I rms : Agilent HP4284A

**Test Instruments :** HP4284A Material/Impedance Analyzer

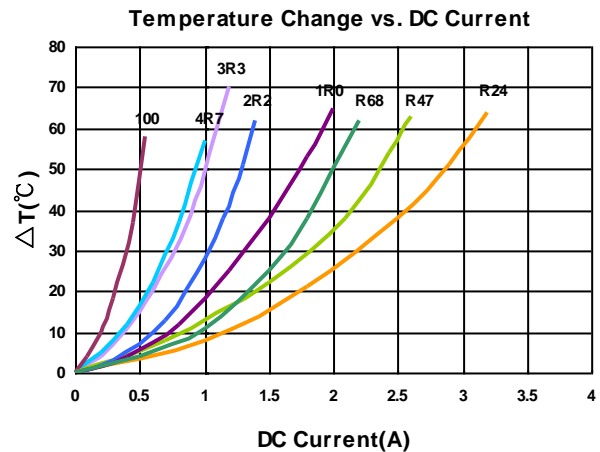
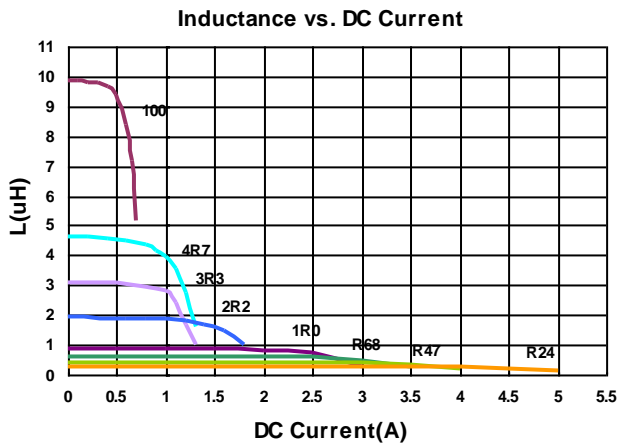

## Electrical Characteristics

Part Number	Inductance (uH)	Tolerance (±%)	Test Frequency (MHz)	RDC (Ω) ±30%	Isat (mA) Typ. (Max)	Irms (mA) Typ. (Max)
BWVH00252010R24□H1	0.24	20, 30	1	0.030	4700(4200)	3600(3000)
BWVH00252010R47□H1	0.47	20, 30	1	0.043	3300(3000)	2700(2300)
BWVH00252010R68□H1	0.68	20, 30	1	0.062	2800(2500)	2300(1900)
BWVH002520101R0□H1	1.0	20, 30	1	0.080	2300(2100)	1900(1600)
BWVH002520102R2□H1	2.2	20, 30	1	0.135	1600(1400)	1400(1100)
BWVH002520104R7□H1	4.7	20, 30	1	0.330	1000(900)	850(720)
BWVH00252010100□H1	10	20, 30	1	0.670	720(640)	580(490)

**Note: When ordering, please specify tolerance code. Tolerance: M=±20% , T =±30%**

- Operating temperature range - 55°C ~ 125°C(Including self - temperature rise)
- Isat for Inductance drop 30% from its value without current
- Irms for a 40°C temperature rise from 25°C ambient with current
- Measure Equipment :
- L : Agilent HP4287A+Agilent HP16197A, 1MHz 200mV
- RDC : DIGITAL MILLINHM METER CHROMA 16502, or equivalent
- Isat & Irms : Agilent HP4284A

## Test Instruments : HP4284A Material/Impedance Analyzer

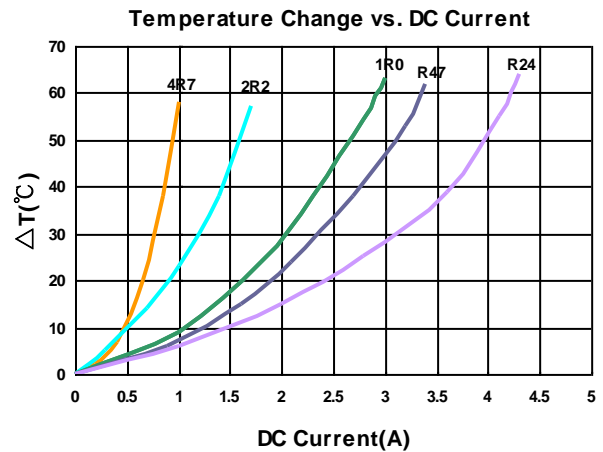
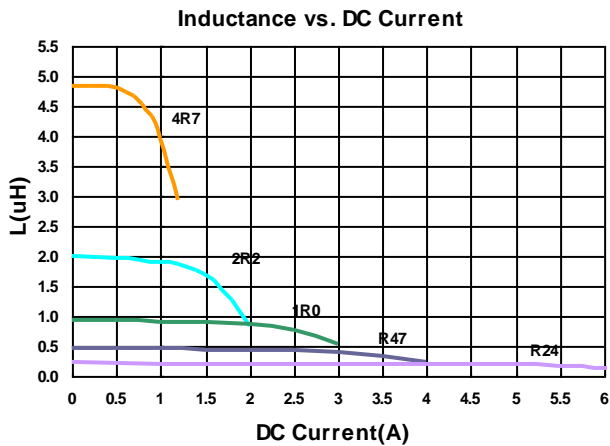

## Electrical Characteristics

Part Number	Inductance (uH)	Tolerance (±%)	Test Frequency (MHz)	RDC (Ω) ±30%	Isat (mA) Typ. (Max)	Irms (mA) Typ. (Max)
BWVH00252012R47□H1	0.47	20, 30	1	0.031	4100(3700)	3100(2600)
BWVH00252012R68□H1	0.68	20, 30	1	0.031	3100(2900)	3100(2600)
BWVH002520121R0□H1	1.0	20, 30	1	0.049	3200(3000)	3000(2500)
BWVH002520121R5□H1	1.5	20, 30	1	0.088	2300(2100)	2200(1800)
BWVH002520122R2□H1	2.2	20, 30	1	0.099	2200(2000)	2000(1700)
BWVH002520123R3□H1	3.3	20, 30	1	0.190	1400(1200)	1200(1000)
BWVH002520124R7□H1	4.7	20, 30	1	0.235	1300(1100)	1100(930)
BWVH00252012100□H1	10	20, 30	1	0.510	920(820)	800(680)

**Note: When ordering, please specify tolerance code. Tolerance: M=±20% , T =±30%**

- Operating temperature range - 55°C ~ 125°C(Including self - temperature rise)
- Isat for Inductance drop 30% from its value without current
- Irms for a 40°C temperature rise from 25°C ambient with current
- Measure Equipment :
- L : Agilent HP4287A+Agilent HP16197A, 1MHz 200mV
- RDC : DIGITAL MILLINHM METER CHROMA 16502, or equivalent
- Isat & Irms : Agilent HP4284A

**Test Instruments :** HP4284A Material/Impedance Analyzer

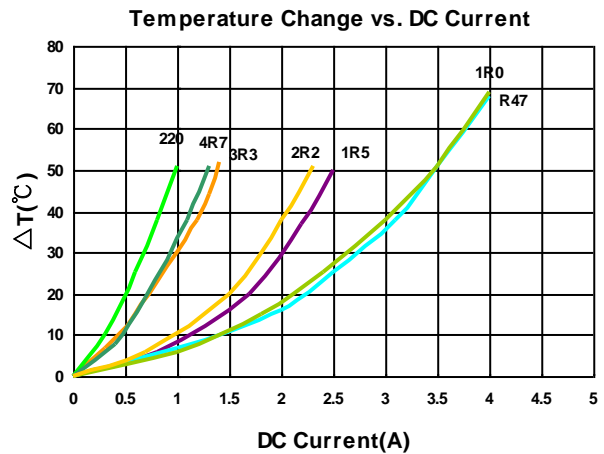
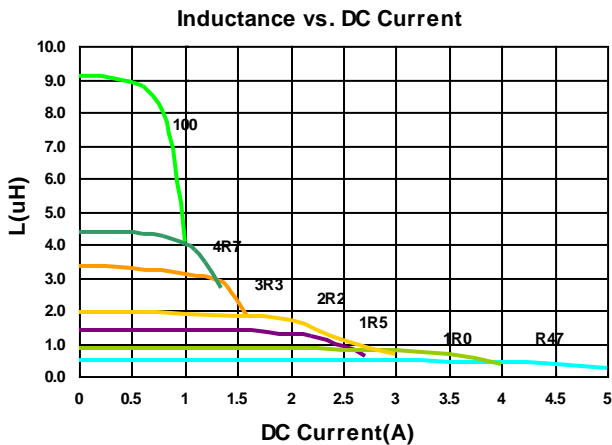

# Sealed Power Inductors - BWVH Series

## Electrical Characteristics

Part Number	Inductance (uH)	Tolerance (±%)	Test Frequency (MHz)	RDC (Ω) ±30%	Isat (mA) Typ. (Max)	Irms (mA) Typ. (Max)	Marking
BWVH00252012R24□00	0.24	20, 30	1	0.021	4700(4200)	3800(3200)	E
BWVH00252012R33□00	0.33	20, 30	1	0.027	4200(3700)	3000(2500)	G
BWVH00252012R47□00	0.47	20, 30	1	0.027	3600(3400)	3000(2500)	J
BWVH00252012R50□00	0.50	20, 30	1	0.027	3600(3400)	3000(2500)	D
BWVH00252012R68□00	0.68	20, 30	1	0.036	2900(2600)	2800(2300)	H
BWVH002520121R0□00	1.0	20, 30	1	0.037	2700(2450)	2600(2200)	A
BWVH002520121R5□00	1.5	20, 30	1	0.075	2200(1900)	1900(1600)	I
BWVH002520122R2□00	2.2	20, 30	1	0.080	1900(1800)	1800(1500)	B
BWVH002520124R7□00	4.7	20, 30	1	0.195	1200(1000)	1100(930)	C
BWVH00252012100□00	10	20, 30	1	0.400	900(800)	800(680)	F
BWVH00252012330□00	33	20, 30	1	1.550	430(380)	380(340)	L
BWVH00252012470□00	47	20, 30	1	1.700	390(350)	340(300)	K

**Note:** When ordering, please specify tolerance code. Tolerance: M=±20% , T =±30%

- Operating temperature range - 55°C ~ 125°C(Including self - temperature rise)
- Isat for Inductance drop 30% from its value without current
- I rms for a 40°C temperature rise from 25°C ambient with current
- Measure Equipment :
- L : Agilent HP4287A+Agilent HP16197A, 1MHz 200mV
- RDC : DIGITAL MILLINHM METER CHROMA 16502, or equivalent
- Isat & I rms : Agilent HP4284A

**Test Instruments :** HP4284A Material/Impedance Analyzer

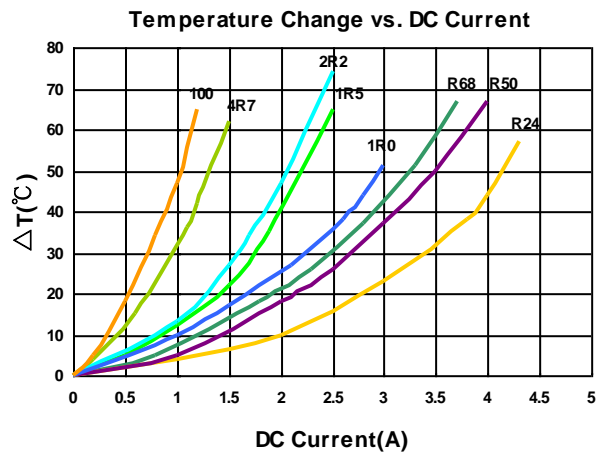
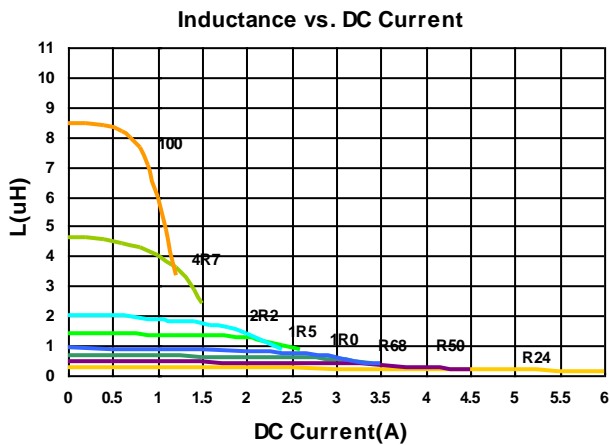

# Sealed Power Inductors - BWVH Series

## Electrical Characteristics

Part Number	Inductance (uH)	Tolerance (±%)	Test Frequency (kHz)	RDC (Ω) ±30%	Isat (mA) Typ. (Max)	Irms (mA) Typ. (Max)	Marking
BWVH005956101R5□00	1.5	20, 30	100	0.086	2400(2100)	2100(1900)	<u>1R5</u>
BWVH005956102R2□00	2.2	20, 30	100	0.110	2200(1900)	1900(1700)	<u>2R2</u>
BWVH005956103R3□00	3.3	20, 30	100	0.135	1800(1600)	1700(1500)	<u>3R3</u>
BWVH005956104R7□00	4.7	20, 30	100	0.165	1500(1300)	1500(1300)	<u>4R7</u>
BWVH005956106R8□00	6.8	20, 30	100	0.210	1400(1200)	1400(1200)	<u>6R8</u>
BWVH00595610100□00	10	20, 30	100	0.270	1100(1000)	1100(1000)	<u>100</u>
BWVH00595610150□00	15	20, 30	100	0.375	800(720)	800(720)	<u>150</u>
BWVH00595610220□00	22	20, 30	100	0.580	690(620)	690(620)	<u>220</u>

**Note: When ordering, please specify tolerance code. Tolerance: M=±20% , T =±30%**

- Operating temperature range - 55°C ~ 125°C(Including self - temperature rise)
- Isat for Inductance drop 10% from its value without current
- I rms for a 40°C temperature rise from 25°C ambient with current
- Measure Equipment :
- L : Agilent HP 4285A+Agilent HP 42841A, 100kHz 1V  
RDC : DIGITAL MILLINHM METER CHROMA 16502, or equivalent  
Isat & I rms : Agilent HP 4285A+Agilent HP 42841A

**Test Instruments :** HP4285A Material/Impedance Analyzer

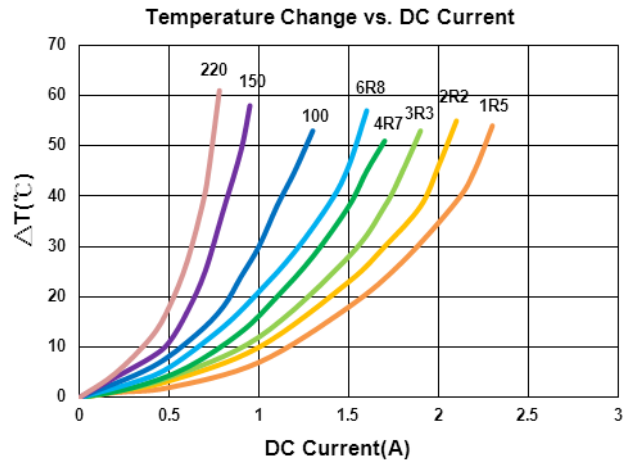
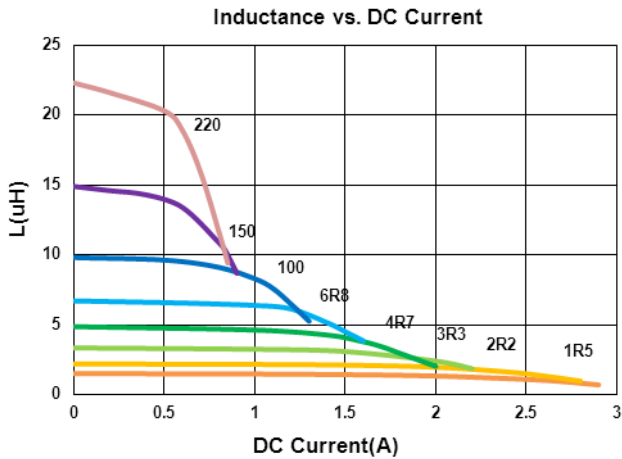

# Sealed Power Inductors - BWVH Series

## Packaging Specifications

Tape Dimensions

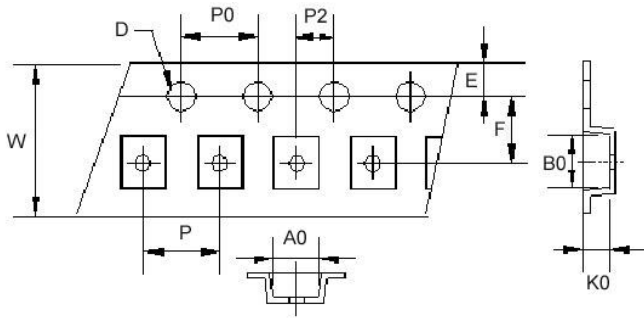

Reel Dimensions

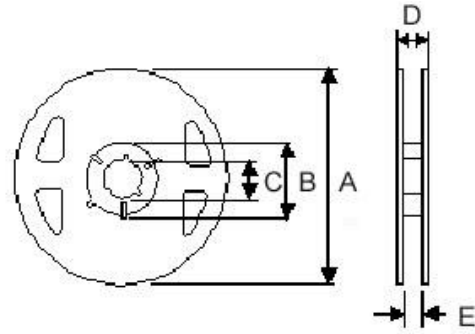

### Dimensions in mm

TYPE	Tape Dimensions										Reel Dimensions					Quantity PCS / Reel
	A0	B0	K0	D	E	F	W	P	P0	P2	A	B	C	D	E	
BWVH00201610	1.9	2.2	1.15	1.55	1.75	3.5	8	4	4	2	180	60	13	14.4	8.4	2000
BWVH00252010	2.4	2.7	1.15	1.55	1.75	3.5	8	4	4	2	180	60	13	14.4	8.4	2000
BWVH00252012	2.4	2.7	1.35	1.55	1.75	3.5	8	4	4	2	180	60	13	14.4	8.4	2000
BWVH00595610	5.9	6.2	1.20	1.55	1.75	7.5	16	12	4	2	330	100	13	-	16	2000



单击下面可查看定价，库存，交付和生命周期等信息

[>>CHILISIN\(奇力新\)](#)