

BDAA Series



The BDAA Series is designed specifically to enhance both PFM and PWM application performance. Q (Rac) value at light load and the RDC value at heavy load are both exceptional. Furthermore, the saturated current performance is also optimal, helping to reduce the ripple current and enhance the efficiency.

Features

- RoHS, Halogen Free and REACH Compliance
- High Efficiency
- Excellent Q, RDC and saturation current
- Low profile and miniature size down to 2.0*1.6*1.0mm

Applications

- Smartphones, tablets, laptop, and smart wearable devices
- HDD, SSD and PC peripheral devices
- Network server
- DC/DC buck converters

Product Identification

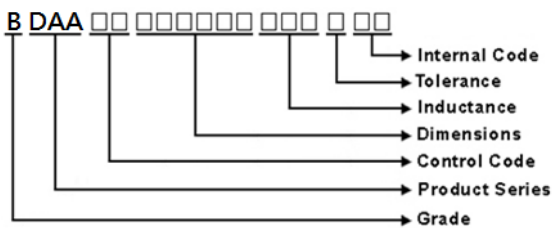

Shape and Dimensions

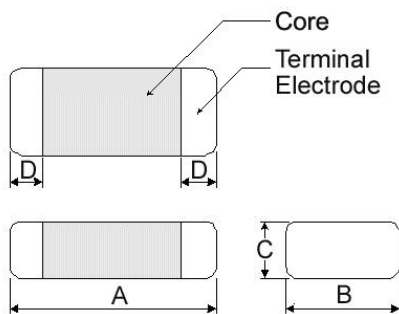

Recommended Pattern

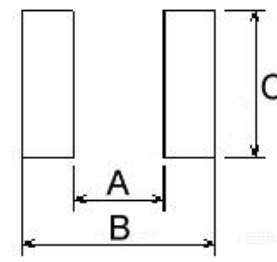

Dimensions in mm

TYPE	A	B	C	D
BDAA00201610	2.0±0.2	1.60±0.2	1.0Max	0.5±0.3
BDAA00201612	2.0±0.2	1.60±0.2	1.2Max	0.5±0.3
BDAA00252010	2.5±0.2	2.00±0.2	1.0Max	0.6±0.3
BDAA00252012	2.5±0.2	2.00±0.2	1.2Max	0.6±0.3
BDAA00322510	3.2±0.3	2.50±0.3	1.0Max	0.6±0.3
BDAA00322512	3.2±0.3	2.50±0.3	1.2Max	0.6±0.3

Dimensions in mm

TYPE	A	B	C
BDAA00201610	0.7	2.3	1.8
BDAA00201612	0.7	2.3	1.8
BDAA00252010	1.2	2.8	2.3
BDAA00252012	1.2	2.8	2.3
BDAA00322510	1.7	3.5	2.8
BDAA00322512	1.7	3.5	2.8

Electrical Characteristics

Part Number	Inductance (uH)	Tolerance (±%)	Test Frequency (MHz)	RDC(mΩ) Max(Typ.)	Isat(A) Max(Typ.)	Irms(A) Max(Typ.)
BDAA00201610R24MC1	0.24	20	2	27(21)	5.6(7.0)	4.6(5.3)
BDAA00201610R47MC1	0.47	20	2	34(28)	5.1(5.8)	4.5(5.0)
BDAA00201610R68MC1	0.68	20	2	43(38)	4.0(4.5)	3.1(3.7)
BDAA002016101R0MC1	1.0	20	2	62(53)	3.0(3.8)	2.7(3.4)
BDAA002016101R5MC1	1.5	20	2	85(75)	2.5(2.8)	2.3(2.7)
BDAA002016102R2MC1	2.2	20	2	135(112)	2.4(2.7)	1.8(2.2)

Note: When ordering, please specify tolerance code. Tolerance: M=±20%

- Operating temperature range: -40°C~125°C (Including self-temperature rise)
- Isat for Inductance drop 30% from its initial inductance value without applying current
- Irms for a 40°C temperature rise from 25°C ambient with applying current
- Rated current: Isat or Irms, whichever is smaller
- Absolute maximum voltage: 20VDC

Test Instruments :

L: WK 6500B/HP4285A (or equivalent), 2MHz 1V

RDC: Chen Hwa 502BC/HP4338B (or equivalent)

Isat: Agilent E4980A+HP42841A (or equivalent)

Irms: Agilent 6641 system DC power supply (or equivalent)

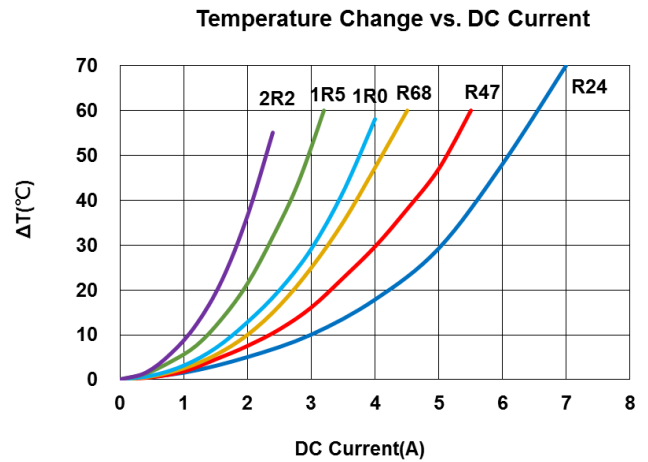
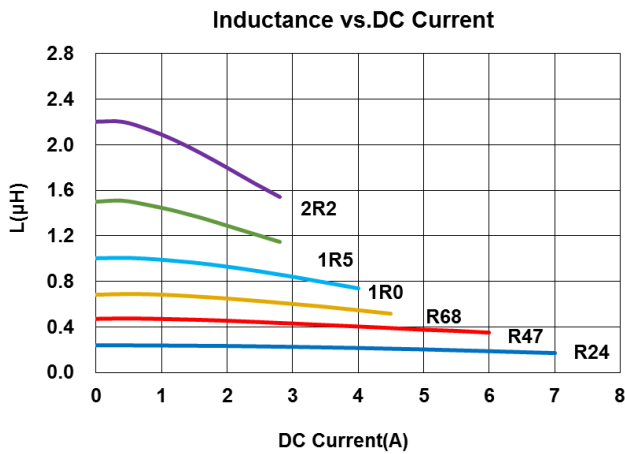

Electrical Characteristics

Part Number	Inductance (uH)	Tolerance (±%)	Test Frequency (MHz)	RDC(mΩ) Max(Typ.)	Isat(A) Max(Typ.)	Irms(A) Max(Typ.)
BDAA00201612R47MC1	0.47	20	2	26(20)	5.5(5.8)	4.5(4.7)
BDAA002016121R0MC1	1.0	20	2	52(43)	3.2(3.8)	3.0(3.5)

Note: When ordering, please specify tolerance code. Tolerance: M=±20%

- Operating temperature range: -40°C~125°C (Including self-temperature rise)
- Isat for Inductance drop 30% from its initial inductance value without applying current
- Irms for a 40°C temperature rise from 25°C ambient with applying current
- Rated current: Isat or Irms, whichever is smaller
- Absolute maximum voltage: 20VDC

Test Instruments :

L: WK 6500B/HP4285A (or equivalent), 2MHz 1V

RDC: Chen Hwa 502BC/HP4338B (or equivalent)

Isat: Agilent E4980A+HP42841A (or equivalent)

Irms: Agilent 6641 system DC power supply (or equivalent)

Inductance vs.DC Current

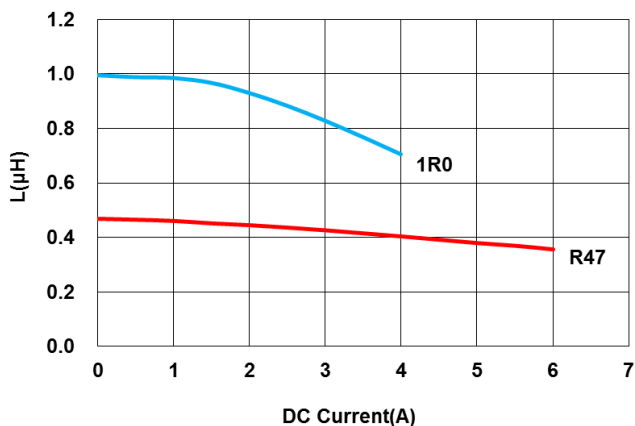

Temperature Change vs. DC Current

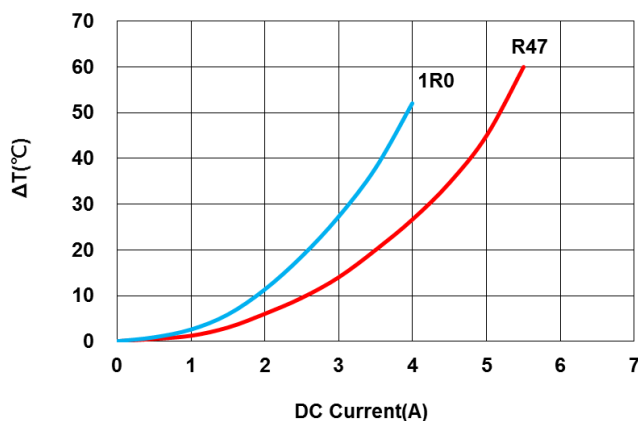

Molding Power Inductors – BDCD Series

Electrical Characteristics

Part Number	Inductance (uH)	Tolerance (±%)	Test Frequency (MHz)	RDC(mΩ) Max(Typ.)	Isat(A) Max(Typ.)	Irms(A) Max(Typ.)
BDAA00252010R24MC1	0.24	20	2	18(13)	8.0(9.5)	5.5(6.5)
BDAA00252010R33MC1	0.33	20	2	24(18)	6.5(8.0)	4.8(5.5)
BDAA00252010R47MC1	0.47	20	2	35(27)	5.0(6.2)	3.9(4.5)
BDAA00252010R68MC1	0.68	20	2	40(32)	4.5(5.6)	3.7(4.2)
BDAA002520101R0MC1	1.0	20	2	48(40)	4.1(4.6)	3.5(4.0)
BDAA002520101R5MC1	1.5	20	2	75(68)	3.1(3.8)	2.4(2.8)
BDAA002520102R2MC1	2.2	20	2	97(87)	2.5(3.0)	2.2(2.5)

Note: When ordering, please specify tolerance code. Tolerance: M=±20%

- Operating temperature range: -40°C~125°C (Including self-temperature rise)
- Isat for Inductance drop 30% from its initial inductance value without applying current
- Irms for a 40°C temperature rise from 25°C ambient with applying current
- Rated current: Isat or Irms, whichever is smaller
- Absolute maximum voltage: 20VDC

Test Instruments :

L: WK 6500B/HP4285A (or equivalent), 2MHz 1V

RDC: Chen Hwa 502BC/HP4338B (or equivalent)

Isat: Agilent E4980A+HP42841A (or equivalent)

Irms: Agilent 6641 system DC power supply (or equivalent)

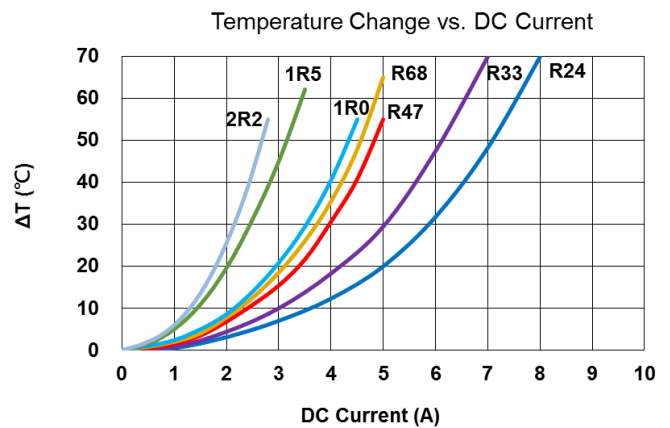
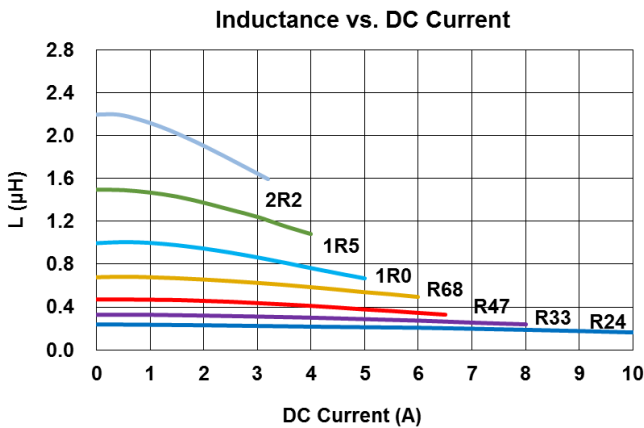

Please be sure to request approval specifications that provide further details of the products. Kindly note that the content of these specifications are subject to change or may be discontinued without prior notice. This product may not be designed/used in medical or high risk applications without Chilisin approval. Please contact our sales department before

Molding Power Inductors – BDCD Series

Electrical Characteristics

Part Number	Inductance (uH)	Tolerance (±%)	Test Frequency (MHz)	RDC(mΩ) Max(Typ.)	Isat(A) Max(Typ.)	Irms(A) Max(Typ.)
BDAA00252012R24MC1	0.24	20	2	15(11)	9.0(10.5)	6.2(7.3)
BDAA00252012R33MC1	0.33	20	2	18(15)	8.5(10.0)	5.8(6.4)
BDAA00252012R47MC1	0.47	20	2	33(28)	5.6(7.0)	3.8(4.5)
BDAA00252012R68MC1	0.68	20	2	36(30)	5.0(6.2)	3.7(4.4)
BDAA002520121R0MC1	1.0	20	2	42(35)	4.4(5.5)	3.6(4.1)
BDAA002520121R5MC1	1.5	20	2	59(52)	3.4(4.2)	2.7(3.1)
BDAA002520122R2MC1	2.2	20	2	86(80)	2.9(3.5)	2.5(2.9)

Note: When ordering, please specify tolerance code. Tolerance: M=±20%

- Operating temperature range: -40°C~125°C (Including self-temperature rise)
- Isat for Inductance drop 30% from its initial inductance value without applying current
- Irms for a 40°C temperature rise from 25°C ambient with applying current
- Rated current: Isat or Irms, whichever is smaller
- Absolute maximum voltage: 20VDC

Test Instruments :

L: WK 6500B/HP4285A (or equivalent), 2MHz 1V

RDC: Chen Hwa 502BC/HP4338B (or equivalent)

Isat: Agilent E4980A+HP42841A (or equivalent)

Irms: Agilent 6641 system DC power supply (or equivalent)

Inductance vs.DC Current

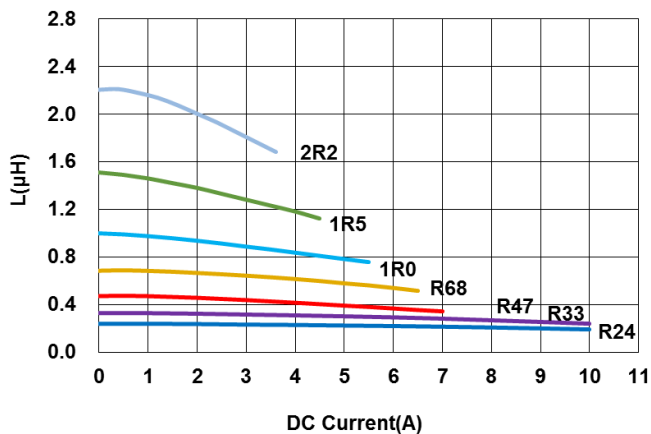

Temperature Change vs. DC Current

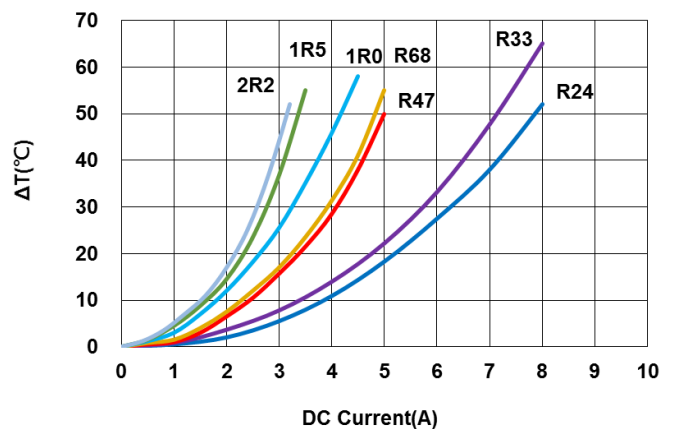

Electrical Characteristics

Part Number	Inductance (uH)	Tolerance (±%)	Test Frequency (MHz)	RDC(mΩ) Max(Typ.)	Isat(A) Max(Typ.)	Irms(A) Max(Typ.)
BDAA00322510R24MC1	0.24	20	2	16(12)	9.0(11.5)	6.0(6.8)
BDAA00322510R33MC1	0.33	20	2	17(13)	8.0(9.5)	5.8(6.5)
BDAA00322510R47MC1	0.47	20	2	24(19)	6.0(7.3)	4.5(5.4)
BDAA003225101R0MC1	1.0	20	2	46(39)	4.1(4.7)	3.3(3.7)
BDAA003225101R5MC1	1.5	20	2	58(50)	3.5(4.0)	3.2(3.5)
BDAA003225102R2MC1	2.2	20	2	85(73)	3.0(3.5)	2.5(2.8)

Note: When ordering, please specify tolerance code. Tolerance: M=±20%

- Operating temperature range: -40°C~125°C (Including self-temperature rise)
- Isat for Inductance drop 30% from its initial inductance value without applying current
- Irms for a 40°C temperature rise from 25°C ambient with applying current
- Rated current: Isat or Irms, whichever is smaller
- Absolute maximum voltage: 20VDC

Test Instruments :

L: WK 6500B/HP4285A (or equivalent), 2MHz 1V

RDC: Chen Hwa 502BC/HP4338B (or equivalent)

Isat: Agilent E4980A+HP42841A (or equivalent)

Irms: Agilent 6641 system DC power supply (or equivalent)

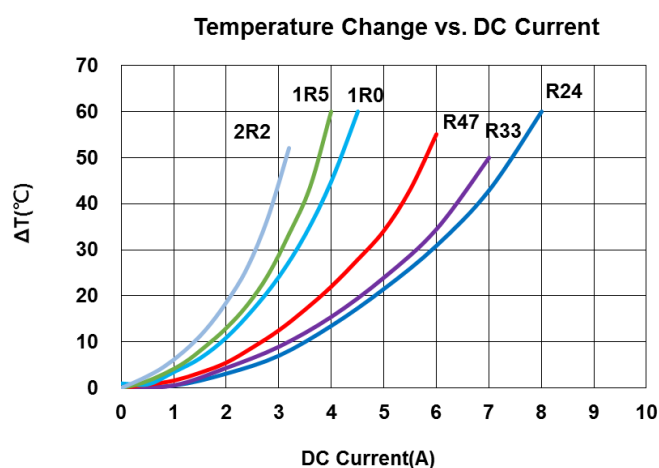
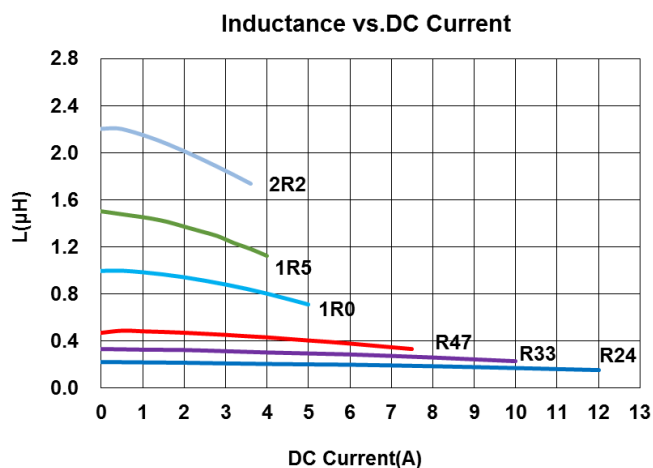

Electrical Characteristics

Part Number	Inductance (uH)	Tolerance (±%)	Test Frequency (MHz)	RDC(mΩ) Max(Typ.)	Isat(A) Max(Typ.)	Irms(A) Max(Typ.)
BDAA00322512R47MC1	0.47	20	2	25(19)	7.0(8.2)	4.6(5.2)
BDAA003225121R0MC1	1.0	20	2	34(28)	5.7(6.5)	3.7(4.2)
BDAA003225121R5MC1	1.5	20	2	59(51)	4.0(4.6)	2.8(3.2)
BDAA003225122R2MC1	2.2	20	2	73(64)	3.5(4.0)	2.7(3.0)

Note: When ordering, please specify tolerance code. Tolerance: M=±20%

- Operating temperature range: -40°C~125°C (Including self-temperature rise)
- Isat for Inductance drop 30% from its initial inductance value without applying current
- Irms for a 40°C temperature rise from 25°C ambient with applying current
- Rated current: Isat or Irms, whichever is smaller
- Absolute maximum voltage: 20VDC

Test Instruments :

L: WK 6500B/HP4285A (or equivalent), 2MHz 1V

RDC: Chen Hwa 502BC/HP4338B (or equivalent)

Isat: Agilent E4980A+HP42841A (or equivalent)

Irms: Agilent 6641 system DC power supply (or equivalent)

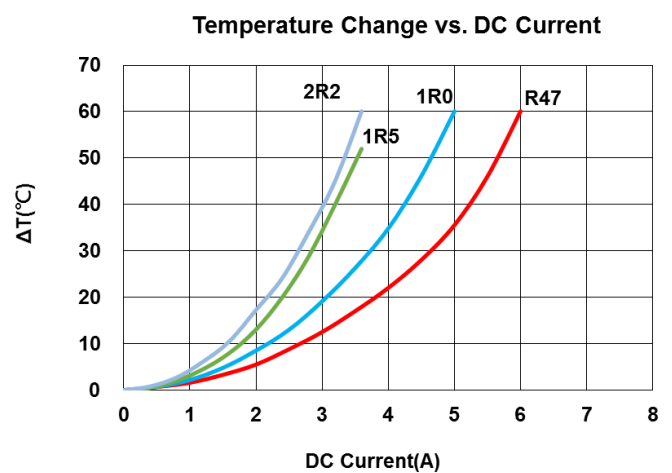
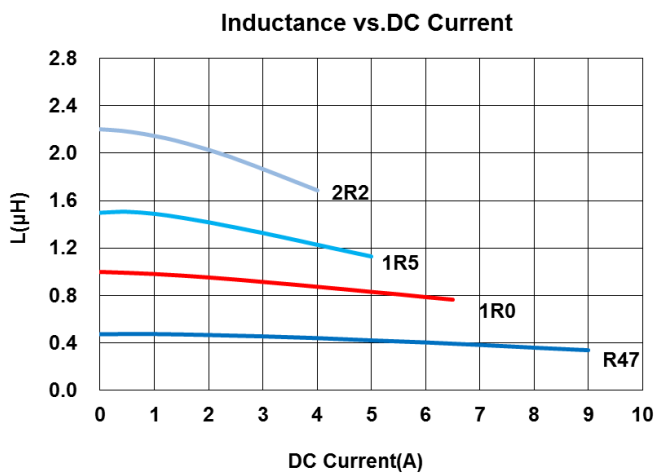

Packaging Specifications

Tape Dimensions

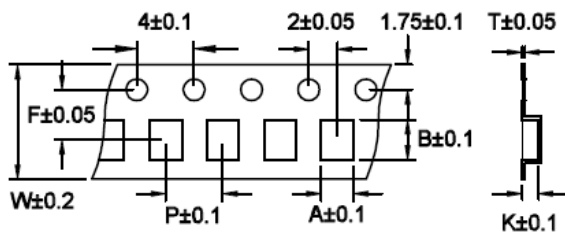

Tape Material

Tape Material
 Carrier Tape: Polycarbonate
 Cover Tape: Polyethylene

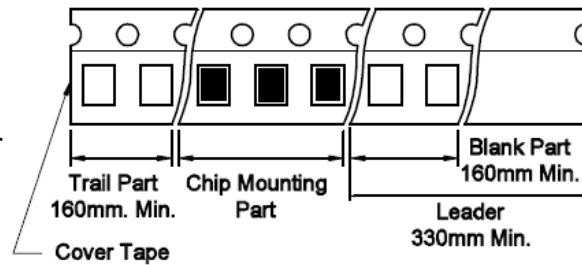

Reel Dimensions

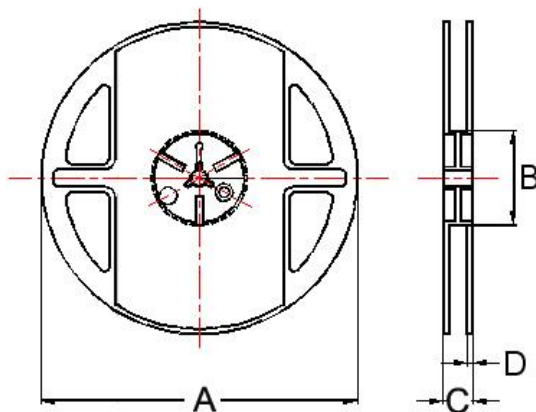

Dimensions in mm

TYPE	Tape Dimensions							Reel Dimensions				Quantity PCS / REEL
	A	B	T	W	P	F	K	A	B	C	D	
BDAA00201610	1.90	2.30	0.22	8	4	3.5	1.15	178	60	12	1.5	3000
BDAA00201612	1.90	2.20	0.22	8	4	3.5	1.15	178	60	12	1.5	3000
BDAA00252010	2.45	2.80	0.22	8	4	3.5	1.20	178	60	12	1.5	3000
BDAA00252012	2.30	2.80	0.22	8	4	3.5	1.35	178	60	12	1.5	3000
BDAA00322510	2.80	3.55	0.23	8	4	3.5	1.20	178	60	12	1.5	3000
BDAA00322512	2.80	3.50	0.23	8	4	3.5	1.34	178	60	12	1.5	3000

单击下面可查看定价，库存，交付和生命周期等信息

[>>CHILISIN\(奇力新\)](#)