

Cautions and Warnings

Please be noted that this spec is only for reference if you have projects designed with the product number listed in. If you are looking for new project design-in, please find BWCS Series specification/datasheet on Chilisin website. Or you may find our sales contact for more information on old part number at your convenience. Appreciated your attention and understanding.

Note: Please be sure to request approval specifications that provide further details of the products. Kindly note that the content of these specifications are subject to change or may be discontinued without prior notice. This product may not be designed/used in medical or high risk applications without Chilisin approval. Please contact our sales department before ordering.

SMD Wire Wound Ceramic Chip Inductors - CS Series

CS0603/0805/1008

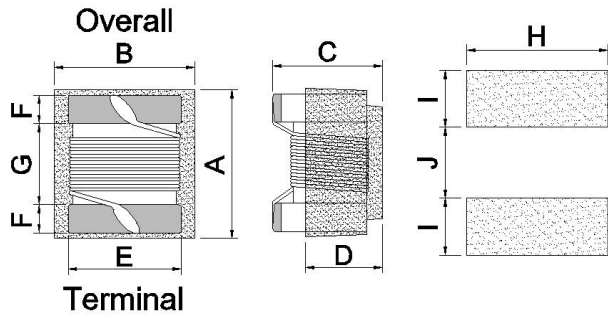

CS1812



Dimensions

		A	B	C	D	E	F	G	H	I	J
CS0603	mm	1.6 ^{+0.2} _{-0.1}	1.02±0.1	0.82 ^{+0.2} _{-0.1}	0.51	0.76	0.33	0.86	1.02	0.64	0.64
		A Max	B Max	C Max	D	E	F	G	H	I	J
CS0805	inch	0.093	0.068	0.06	0.028	0.05	0.02	0.04	0.07	0.04	0.03
	mm	2.35	1.73	1.52	0.71	1.27	0.51	1.02	1.78	1.02	0.76
CS1008	inch	0.115	0.11	0.083	0.046	0.08	0.02	0.06	0.10	0.04	0.05
	mm	2.92	2.79	2.1	1.16	2.03	0.51	1.52	2.54	1.02	1.27
CS1812	inch	0.197	0.154	0.135	0.07	0.1	0.025	0.128	0.12	0.045	0.118
	mm	4.95	3.81	3.43	1.78	2.54	0.64	3.25	3.05	1.14	3.00

NOT FOR NEW DESIGN

SMD Wire Wound Ceramic Chip Inductors - CS Series

Electrical Characteristics

Part Number	Inductance (nH)	Tolerance (±%)	Test Frequency (MHz)	Q Min	SRF (GHz) Typ	RDC (Ω) Max	Irms (mA) Typ
CS0201-0N5□-S	0.5	10	250	4	23.5	0.02	1250
CS0201-0N6□-S	0.6	10	250	6	24.5	0.03	1000
CS0201-1N2□-S	1.2	5	250	13	17.9	0.042	870
CS0201-1N3□-S	1.3	5	250	11	17.6	0.048	820
CS0201-1N4□-S	1.4	5	250	14	17	0.08	630
CS0201-1N5□-S	1.5	5	250	11	17	0.09	600
CS0201-2N2□-S	2.2	5	250	15	16.7	0.07	700
CS0201-2N3□-S	2.3	5	250	18	16.5	0.07	670
CS0201-2N4□-S	2.4	5	250	13	13	0.082	620
CS0201-2N5□-S	2.5	5	250	16	12.5	0.165	440
CS0201-3N3□-S	3.3	5	250	14	12.8	0.08	630
CS0201-3N4□-S	3.4	5	250	11	12.7	0.08	630
CS0201-3N5□-S	3.5	5	250	16	12.4	0.08	630
CS0201-3N6□-S	3.6	5	250	18	12.5	0.105	550
CS0201-3N7□-S	3.7	5	250	15	10.6	0.105	550
CS0201-3N8□-S	3.8	5	250	16	10.2	0.18	420
CS0201-3N9□-S	3.9	5	250	12	11.2	0.24	360
CS0201-4N8□-S	4.8	5	250	17	11	0.096	570
CS0201-4N9□-S	4.9	5	250	18	11.7	0.13	510
CS0201-5N0□-S	5.0	5	250	18	11.5	0.13	510
CS0201-5N1□-S	5.1	5	250	18	11.1	0.13	510
CS0201-5N2□-S	5.2	5	250	18	10	0.17	430
CS0201-5N3□-S	5.3	5	250	18	10.6	0.13	510
CS0201-5N4□-S	5.4	5	250	18	10.2	0.13	510
CS0201-5N5□-S	5.5	5	250	16	9.5	0.285	330
CS0201-6N7□-S	6.7	5	250	18	6.8	0.15	460
CS0201-6N8□-S	6.8	5	250	18	9.5	0.15	460
CS0201-6N9□-S	6.9	5	250	18	9.3	0.15	460
CS0201-7N0□-S	7.0	5	250	18	6.7	0.21	390
CS0201-7N1□-S	7.1	5	250	18	9.5	0.25	390
CS0201-7N2□-S	7.2	5	250	18	9.4	0.25	390
CS0201-7N3□-S	7.3	5	250	18	9.3	0.25	390
CS0201-7N4□-S	7.4	5	250	18	9.1	0.25	390
CS0201-7N5□-S	7.5	5	250	15	6.8	0.34	300
CS0201-7N6□-S	7.6	5	250	17	9.3	0.3	340
CS0201-7N7□-S	7.7	5	250	17	9.2	0.3	340
CS0201-7N8□-S	7.8	5	250	17	9.2	0.3	340
CS0201-7N9□-S	7.9	5	250	17	9.1	0.3	340
CS0201-8N0□-S	8.0	5	250	17	9.2	0.3	340
CS0201-8N1□-S	8.1	5	250	17	9.1	0.3	340
CS0201-8N2□-S	8.2	5	250	17	6.4	0.27	340

Note: When ordering, please specify tolerance code. Tolerance : J=±5% , K=±10%

- Operating temperature range - 40°C ~ 125°C(Including self - temperature rise)
- Irms for a 15°C temperature rise from 25°C ambient with current
- Measure Equipment :
L & Q : HP4286A/HP4287A/AgilentE4991/Keysight E4982A
SRF : Agilent HP8753D/Agilent HP8722ES
RDC : HP4287A/Keysight E4982A
Irms : HP4284A+HP42841A/HP4285A+HP42841A

Please be sure to request approval specifications that provide further details of the products. Kindly note that the content of these specifications are subject to change or may be discontinued without prior notice. This product may not be designed/used in medical or high risk applications without Chilisin approval. Please contact our sales department before ordering.



CHILISIN ELECTRONICS CORP.

SMD Wire Wound Ceramic Chip Inductors - CS Series

Electrical Characteristics

Part Number	Inductance (nH)	Tolerance (±%)	Test Frequency (MHz)	Q Min	SRF (GHz) Typ	RDC (Ω) Max	Irms (mA) Typ
CS0201-8N3□-S	8.3	5	250	17	8.9	0.3	340
CS0201-8N4□-S	8.4	5	250	15	8.9	0.38	300
CS0201-8N5□-S	8.5	5	250	15	8.9	0.38	300
CS0201-8N7□-S	8.7	5	250	15	6.3	0.38	300
CS0201-9N0□-S	9.0	5	250	15	6.4	0.38	300
CS0201-9N4□-S	9.4	5	250	16	6.4	0.4	280
CS0201-9N6□-S	9.6	5	250	16	6.2	0.4	280
CS0201-11N□-S	11	5	250	16	5.7	0.44	280
CS0201-12N□-S	12	5	250	17	5.6	0.36	300
CS0201-13N□-S	13	5	250	16	6.7	0.5	270
CS0201-14N□-S	14	5	250	16	5.1	0.5	270

Note: When ordering, please specify tolerance code. Tolerance : J=±5% , K=±10%

- Operating temperature range - 40°C ~ 125°C(Including self - temperature rise)
- Irms for a 15°C temperature rise from 25°C ambient with current
- Measure Equipment :

L & Q : HP4286A/HP4287A/AgilentE4991/Keysight E4982A

SRF : Agilent HP8753D/Agilent HP8722ES

RDC : HP4287A/Keysight E4982A

Irms : HP4284A+HP42841A/HP4285A+HP42841A

Typical L vs. Frequency

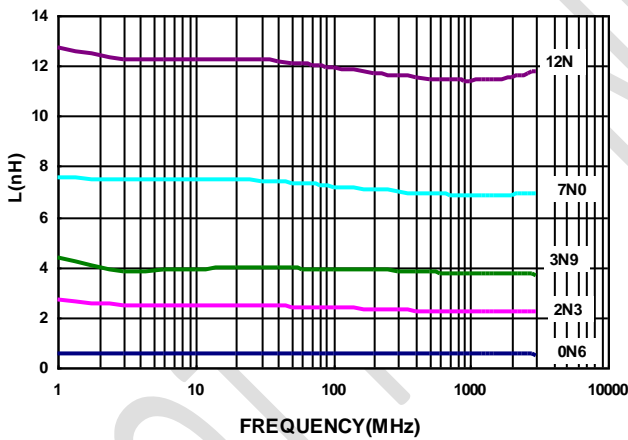

Typical Q vs. Frequency

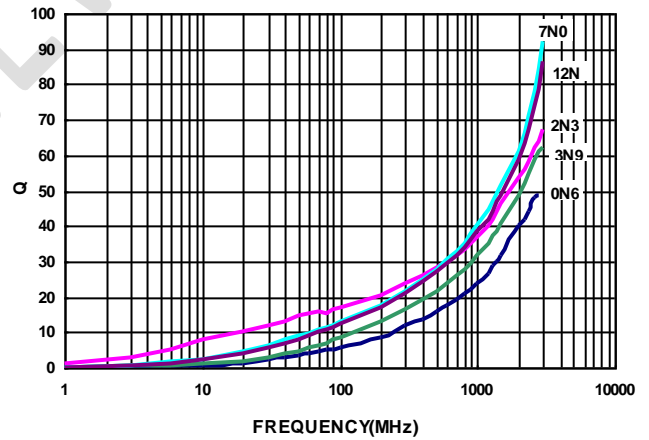

SMD Wire Wound Ceramic Chip Inductors - CS Series

Electrical Characteristics

Part Number	Inductance (nH)	Tolerance (±%)	Test Frequency (MHz)	Q Min	SRF (GHz) Min	RDC (Ω) Max	Irms (mA) Max
CS0402-1N0□-S	1.0	10 / 5 / ±0.1nH	250	16	12.7	0.045	1360
CS0402-1N2□-S	1.2	10 / 5 / ±0.1nH	250	10	10.4	0.140	640
CS0402-1N3□-S	1.3	10 / ±0.1nH	250	10	10.4	0.140	640
CS0402-1N9□-S	1.9	10 / 5 / ±0.1nH	250	16	11.3	0.070	1040
CS0402-2N0□-S	2.0	10 / 5 / ±0.1nH	250	16	11.1	0.070	1040
CS0402-2N2□-S	2.2	10 / 5 / ±0.1nH	250	19	10.8	0.070	960
CS0402-2N4□-S	2.4	10 / 5 / ±0.1nH	250	15	10.5	0.068	790
CS0402-2N5□-S	2.5	10 / 5 / ±0.1nH	250	13	10.4	0.150	640
CS0402-2N7□-S	2.7	10 / 5 / ±0.1nH	250	16	10.4	0.120	640
CS0402-3N3□-S	3.3	10 / 5 / 3	250	19	7.00	0.066	840
CS0402-3N6□-S	3.6	10 / 5 / 3	250	19	6.80	0.066	840
CS0402-3N9□-S	3.9	10 / 5 / 3	250	19	6.00	0.066	840
CS0402-4N3□-S	4.3	10 / 5 / 3	250	18	6.00	0.091	700
CS0402-4N7□-S	4.7	10 / 5 / 3	250	15	4.77	0.130	640
CS0402-5N1□-S	5.1	10 / 5 / 3	250	20	4.80	0.083	800
CS0402-5N6□-S	5.6	10 / 5 / 3	250	20	4.80	0.083	760
CS0402-5N8□-S	5.8	10 / 5 / 3	250	20	4.80	0.083	760
CS0402-6N2□-S	6.2	10 / 5 / 3	250	20	4.80	0.083	760
CS0402-6N8□-S	6.8	10 / 5 / 3	250	20	4.80	0.083	680
CS0402-7N3□-S	7.3	10 / 5 / 3	250	20	4.80	0.12	680
CS0402-7N5□-S	7.5	10 / 5 / 3	250	22	4.80	0.10	680
CS0402-8N2□-S	8.2	10 / 5 / 3	250	22	4.40	0.10	680
CS0402-8N7□-S	8.7	10 / 5 / 3	250	18	4.10	0.20	480
CS0402-9N0□-S	9.0	10 / 5 / 3	250	22	4.16	0.10	680
CS0402-9N1□-S	9.1	10 / 5 / 3	250	22	4.16	0.10	680
CS0402-9N5□-S	9.5	10 / 5 / 3	250	18	4.00	0.20	480
CS0402-10N□-S	10	10 / 5 / 3 / 2	250	21	3.90	0.20	480
CS0402-11N□-S	11	10 / 5 / 3 / 2	250	24	3.68	0.12	640
CS0402-12N□-S	12	10 / 5 / 3 / 2	250	24	3.60	0.12	640
CS0402-13N□-S	13	10 / 5 / 3 / 2	250	24	3.45	0.21	440
CS0402-15N□-S	15	10 / 5 / 3 / 2	250	24	3.28	0.17	560
CS0402-16N□-S	16	10 / 5 / 3 / 2	250	24	3.10	0.22	560
CS0402-18N□-S	18	10 / 5 / 3 / 2	250	25	3.10	0.23	420
CS0402-19N□-S	19	10 / 5 / 3 / 2	250	24	3.04	0.20	480
CS0402-20N□-S	20	10 / 5 / 3 / 2	250	25	3.00	0.25	420
CS0402-22N□-S	22	10 / 5 / 3 / 2	250	25	2.80	0.30	400
CS0402-23N□-S	23	10 / 5 / 3 / 2	250	22	2.72	0.30	400
CS0402-24N□-S	24	10 / 5 / 3 / 2	250	25	2.70	0.30	400
CS0402-27N□-S	27	10 / 5 / 3 / 2	250	24	2.48	0.30	400
CS0402-30N□-S	30	10 / 5 / 3 / 2	250	25	2.35	0.35	400

Note: When ordering, please specify tolerance code. Tolerance : B=±0.1nH , G=±2% , H=±3% , J=±5% , K=±10%

- Operating temperature range - 40°C ~ 125°C(Including self - temperature rise)
- I rms for a 15°C temperature rise from 25°C ambient with current
- Measure Equipment :
 L & Q : Agilent E4991A+Agilent HP16197A
 SRF : Agilent HP8753D/Agilent HP8722ES
 RDC : HP4287A
 I rms : HP4284A+HP42841A/HP4285A+HP42841A

SMD Wire Wound Ceramic Chip Inductors - CS Series

Electrical Characteristics

Part Number	Inductance (nH)	Tolerance (±%)	Test Frequency (MHz)	Q Min	SRF (GHz) Min	RDC (Ω) Max	Irms (mA) Max
CS0402-33N□-S	33	10 / 5 / 3 / 2	250	24	2.35	0.40	400
CS0402-36N□-S	36	10 / 5 / 3 / 2	250	24	2.32	0.44	320
CS0402-39N□-S	39	10 / 5 / 3 / 2	250	25	2.10	0.55	200
CS0402-40N□-S	40	10 / 5 / 3 / 2	250	24	2.24	0.65	320
CS0402-43N□-S	43	10 / 5 / 3 / 2	250	25	2.03	0.81	100
CS0402-47N□-S	47	10 / 5 / 3 / 2	250	20	2.10	0.83	150
CS0402-51N□-S	51	10 / 5 / 3 / 2	250	25	1.75	0.82	100
CS0402-56N□-S	56	10 / 5 / 3 / 2	250	22	1.76	0.97	100
CS0402-68N□-S	68	10 / 5 / 3 / 2	250	22	1.62	1.12	100
CS0402-82N□-S	82	10 / 5 / 3 / 2	250	20	1.26	1.55	50
CS0402-R10□-S	100	10 / 5 / 3 / 2	250	20	1.16	2.00	30
CS0402-R18□-S	180	10 / 5 / 3 / 2	100	8	0.70	2.70	50
CS0402-R22□-S	220	10 / 5 / 3 / 2	100	8	0.70	4.00	50

Note: When ordering, please specify tolerance code. Tolerance : B=±0.1nH , G=±2% , H=±3% , J=±5% , K=±10%

- Operating temperature range - 40°C ~ 125°C(Including self - temperature rise)
- I_{rms} for a 15°C temperature rise from 25°C ambient with current
- Measure Equipment :
 L & Q : Agilent E4991A+Agilent HP16197A
 SRF : Agilent HP8753D/Agilent HP8722ES
 RDC : HP4287A
 I_{rms} : HP4284A+HP42841A/HP4285A+HP42841A

Typical L vs. Frequency



Typical Q vs. Frequency



SMD Wire Wound Ceramic Chip Inductors – CS Series

Electrical Characteristics

Part Number	Inductance (nH)	Tolerance (±%)	Test Frequency (MHz)	Q Min	SRF (MHz) Min	RDC (Ω) Max	Irms (mA) Max	Color
CS0603-1N6□-S	1.6	10 / 5 / ±0.1nH	250	24	12500	0.030	700	Red
CS0603-1N8□-S	1.8	10 / 5 / ±0.1nH	250	16	12500	0.045	700	Black
CS0603-2N2□-S	2.2	10 / 5 / ±0.1nH	250	13	12500	0.250	700	Yellow
CS0603-3N3□-S	3.3	10 / 5 / 3	250	35	5900	0.045	700	Blue
CS0603-3N6□-S	3.6	10 / 5 / 3 / 2	250	22	5900	0.063	700	Red
CS0603-3N9□-S	3.9	10 / 5 / 3 / 2	250	22	6900	0.080	700	Brown
CS0603-4N3□-S	4.3	10 / 5 / 3 / 2	250	22	5900	0.063	700	Orange
CS0603-4N7□-S	4.7	10 / 5 / 3 / 2	250	20	5800	0.116	700	Violet
CS0603-5N1□-S	5.1	10 / 5 / 3 / 2	250	20	5700	0.140	700	Green
CS0603-5N6□-S	5.6	10 / 5 / 3 / 2	250	20	5800	0.170	700	Yellow
CS0603-6N3□-S	6.3	10 / 5 / 3 / 2	250	20	5700	0.140	700	White
CS0603-6N8□-S	6.8	10 / 5 / 3 / 2	250	27	5800	0.110	700	Red
CS0603-7N5□-S	7.5	10 / 5 / 3 / 2	250	28	4800	0.106	700	Brown
CS0603-8N2□-S	8.2	10 / 5 / 3 / 2	250	28	4700	0.109	700	White
CS0603-8N7□-S	8.7	10 / 5 / 3 / 2	250	28	4600	0.109	700	Yellow
CS0603-9N1□-S	9.1	10 / 5 / 3 / 2	250	28	4800	0.120	700	Violet
CS0603-9N5□-S	9.5	10 / 5 / 3 / 2	250	28	5400	0.135	700	Blue
CS0603-10N□-S	10	10 / 5 / 3 / 2	250	31	4800	0.130	700	Orange
CS0603-11N□-S	11	10 / 5 / 3 / 2	250	33	4000	0.086	700	Gray
CS0603-12N□-S	12	10 / 5 / 3 / 2	250	35	4000	0.130	700	Yellow
CS0603-13N□-S	13	10 / 5 / 3 / 2	250	30	4000	0.160	700	Black
CS0603-15N□-S	15	10 / 5 / 3 / 2	250	35	4000	0.170	700	Green
CS0603-16N□-S	16	10 / 5 / 3 / 2	250	34	3300	0.104	700	White
CS0603-18N□-S	18	10 / 5 / 3 / 2	250	35	3100	0.170	700	Blue
CS0603-20N□-S	20	10 / 5 / 3 / 2	250	38	3000	0.190	700	Red
CS0603-22N□-S	22	10 / 5 / 3 / 2	250	38	3000	0.190	700	Violet
CS0603-23N□-S	23	10 / 5 / 3 / 2	250	38	2850	0.190	700	Orange
CS0603-24N□-S	24	10 / 5 / 3 / 2	250	37	2650	0.135	700	Black
CS0603-27N□-S	27	10 / 5 / 3 / 2	250	40	2800	0.220	600	Gray
CS0603-30N□-S	30	10 / 5 / 3 / 2	250	37	2250	0.144	600	Brown
CS0603-33N□-S	33	10 / 5 / 3 / 2	250	40	2300	0.220	600	White
CS0603-36N□-S	36	10 / 5 / 3 / 2	250	38	2080	0.250	600	Red
CS0603-39N□-S	39	10 / 5 / 3 / 2	250	40	2200	0.250	600	Black
CS0603-43N□-S	43	10 / 5 / 3 / 2	250	39	2000	0.280	600	Orange
CS0603-47N□-S	47	10 / 5 / 3 / 2	200	38	2000	0.280	600	Brown
CS0603-51N□-S	51	10 / 5 / 3 / 2	200	38	1900	0.310	600	Brown
CS0603-56N□-S	56	10 / 5 / 3 / 2	200	38	1900	0.310	600	Red
CS0603-68N□-S	68	10 / 5 / 3 / 2	200	37	1700	0.340	600	Orange
CS0603-72N□-S	72	10 / 5 / 3 / 2	150	34	1700	0.490	400	Yellow
CS0603-82N□-S	82	10 / 5 / 3 / 2	150	34	1700	0.540	400	Green
CS0603-91N□-S	91	10 / 5 / 3 / 2	150	34	1400	0.580	400	Black

Note: When ordering, please specify tolerance code. Tolerance : B=±0.1nH , G=±2% , H=±3% , J=±5% , K=±10%

- Operating temperature range - 40°C ~ 125°C(Including self - temperature rise)
- Irms for a 15°C temperature rise from 25°C ambient with current
- Measure Equipment :

L & Q : Agilent E4991A+Agilent HP16197A

SRF : Agilent HP8753D/Agilent E4991A

RDC : Chroma 16502

Irms : HP4284A+HP42841A/HP4285A+HP42841A

Please be sure to request approval specifications that provide further details of the products. Kindly note that the content of these specifications are subject to change or may be discontinued without prior notice. This product may not be designed/used in medical or high risk applications without Chilisin approval. Please contact our sales department before ordering.



SMD Wire Wound Ceramic Chip Inductors – CS Series

Electrical Characteristics

Part Number	Inductance (nH)	Tolerance (±%)	Test Frequency (MHz)	Q Min	SRF (MHz) Min	RDC (Ω) Max	Irms (mA) Max	Color
CS0603-R10□-S	100	10 / 5 / 3 / 2	150	34	1400	0.580	400	Blue
CS0603-R11□-S	110	10 / 5 / 3 / 2	150	32	1350	0.610	300	Violet
CS0603-R12□-S	120	10 / 5 / 3 / 2	150	32	1300	0.750	300	Gray
CS0603-R15□-S	150	10 / 5 / 3 / 2	150	28	990	0.920	280	White
CS0603-R16□-S	160	10 / 5 / 3 / 2	100	25	990	1.250	240	Yellow
CS0603-R18□-S	180	10 / 5 / 3 / 2	100	25	990	1.250	240	Black
CS0603-R20□-S	200	10 / 5 / 3 / 2	100	25	900	2.100	200	Red
CS0603-R21□-S	210	10 / 5 / 3 / 2	100	27	895	2.060	200	Gray
CS0603-R22□-S	220	10 / 5 / 3 / 2	100	25	900	2.100	200	Brown
CS0603-R24□-S	240	10 / 5 / 3 / 2	100	25	900	2.200	200	Green
CS0603-R25□-S	250	10 / 5 / 3 / 2	100	25	822	3.550	120	Violet
CS0603-R27□-S	270	10 / 5 / 3 / 2	100	24	900	2.800	170	Red
CS0603-R33□-S	330	10 / 5 / 3 / 2	100	25	900	3.890	100	Orange
CS0603-R39□-S	390	10 / 5 / 3 / 2	100	25	900	4.350	100	Yellow
CS0603-R47□-S	470	10 / 5 / 3 / 2	100	25	500	4.500	100	Brown
CS0603-R56□-S	560	10 / 5 / 3 / 2	100	23	460	4.700	90	Blue

Note: When ordering, please specify tolerance code. Tolerance : B=±0.1nH , G=±2% , H=±3% , J=±5% , K=±10%

- Operating temperature range - 40°C ~ 125°C(Including self - temperature rise)
- Irms for a 15°C temperature rise from 25°C ambient with current
- Measure Equipment :

L & Q : Agilent E4991A+Agilent HP16197A

SRF : Agilent HP8753D/Agilent E4991A

RDC : Chroma 16502

Irms : HP4284A+HP42841A/HP4285A+HP42841A

Typical L vs. Frequency



Typical Q vs. Frequency

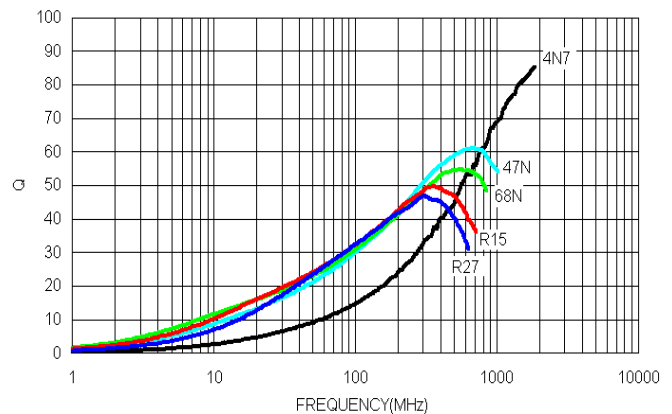

Please be sure to request approval specifications that provide further details of the products. Kindly note that the content of these specifications are subject to change or may be discontinued without prior notice. This product may not be designed/used in medical or high risk applications without Chilisin approval. Please contact our sales department before ordering.



SMD Wire Wound Ceramic Chip Inductors – CS Series

Electrical Characteristics

Part Number	Inductance (nH)	Tolerance (±%)	Test Frequency (MHz)	Q Min	Test Frequency (MHz)	SRF (MHz) Min	RDC (Ω) Max	I _{rms} (mA) Max	Color
CS0805-2N7□-S	2.7	10 / 5 / 2	250	50	1500	7900	0.06	800	Yellow
CS0805-2N8□-S	2.8	10 / 5 / 2	250	80	1500	7900	0.06	800	Gray
CS0805-3N0□-S	3.0	10 / 5 / 2	250	65	1500	7900	0.06	800	White
CS0805-3N3□-S	3.3	10 / 5 / 2	250	50	1500	7900	0.08	600	Black
CS0805-5N6□-S	5.6	10 / 5 / 2	250	65	1000	5500	0.08	600	Orange
CS0805-6N8□-S	6.8	10 / 5 / 2	250	50	1000	5500	0.11	600	Brown
CS0805-7N5□-S	7.5	10 / 5 / 2	250	50	1000	4500	0.14	600	Green
CS0805-8N2□-S	8.2	10 / 5 / 2	250	50	1000	4700	0.12	600	Red
CS0805-10N□-S	10	10 / 5 / 2	250	60	500	4200	0.10	600	Blue
CS0805-12N□-S	12	10 / 5 / 2	250	50	500	4000	0.15	600	Orange
CS0805-15N□-S	15	10 / 5 / 2	250	50	500	3400	0.17	600	Yellow
CS0805-18N□-S	18	10 / 5 / 2	250	50	500	3300	0.20	600	Green
CS0805-22N□-S	22	10 / 5 / 2	250	55	500	2600	0.22	500	Blue
CS0805-24N□-S	24	10 / 5 / 2	250	50	500	2000	0.22	500	Gray
CS0805-27N□-S	27	10 / 5 / 2	250	55	500	2500	0.25	500	Violet
CS0805-33N□-S	33	10 / 5 / 2	250	60	500	2050	0.27	500	Gray
CS0805-36N□-S	36	10 / 5 / 2	250	55	500	1700	0.27	500	Orange
CS0805-39N□-S	39	10 / 5 / 2	250	60	500	2000	0.29	500	White
CS0805-43N□-S	43	10 / 5 / 2	200	60	500	1650	0.34	500	Yellow
CS0805-47N□-S	47	10 / 5 / 2	200	60	500	1650	0.31	500	Black
CS0805-56N□-S	56	10 / 5 / 2	200	60	500	1550	0.34	500	Brown
CS0805-68N□-S	68	10 / 5 / 2	200	60	500	1450	0.38	500	Red
CS0805-82N□-S	82	10 / 5 / 2	150	65	500	1300	0.42	400	Orange
CS0805-91N□-S	91	10 / 5 / 2	150	65	500	1200	0.48	400	Black
CS0805-R10□-S	100	10 / 5 / 2	150	65	500	1200	0.46	400	Yellow
CS0805-R11□-S	110	10 / 5 / 2	150	50	250	1000	0.48	400	Brown
CS0805-R12□-S	120	10 / 5 / 2	150	50	250	1100	0.51	400	Green
CS0805-R15□-S	150	10 / 5 / 2	100	50	250	920	0.56	400	Blue
CS0805-R18□-S	180	10 / 5 / 2	100	50	250	870	0.64	400	Violet
CS0805-R20□-S	200	10 / 5 / 2	100	50	250	860	0.68	400	Red
CS0805-R22□-S	220	10 / 5 / 2	100	50	250	850	0.70	400	Gray
CS0805-R24□-S	240	10 / 5 / 2	100	44	250	690	1.00	350	Red
CS0805-R25□-S	250	10 / 5 / 2	100	45	250	660	1.20	350	Yellow
CS0805-R27□-S	270	10 / 5 / 2	100	48	250	650	1.00	350	White
CS0805-R30□-S	300	10 / 5 / 2	100	25	250	450	1.40	310	Orange
CS0805-R33□-S	330	10 / 5 / 2	100	48	250	600	1.40	310	Black
CS0805-R39□-S	390	10 / 5 / 2	100	48	250	560	1.50	290	Brown
CS0805-R47□-S	470	10 / 5 / 2	50	33	100	450	1.76	250	Violet
CS0805-R51□-S	510	10 / 5 / 2	25	23	50	340	1.90	230	Gray
CS0805-R56□-S	560	10 / 5 / 2	25	23	50	340	1.90	230	Orange
CS0805-R62□-S	620	10 / 5 / 2	25	23	50	220	2.20	210	Yellow
CS0805-R68□-S	680	10 / 5 / 2	25	23	50	188	2.20	190	Green

Note: When ordering, please specify tolerance code. Tolerance : G=±2% , J=±5% , K=±10%

- Operating temperature range - 40°C ~ 125°C(Including self - temperature rise)
- I_{rms} for a 15°C temperature rise from 25°C ambient with current
- Measure Equipment :
 - L & Q : Agilent E4991A+Agilent HP16197A
 - SRF : Agilent HP8753D/Agilent E4991A
 - RDC : Chroma 16502
 - I_{rms} : HP4284A+HP42841A/HP4285A+HP42841A

Please be sure to request approval specifications that provide further details of the products. Kindly note that the content of these specifications are subject to change or may be discontinued without prior notice. This product may not be designed/used in medical or high risk applications without Chilisin approval. Please contact our sales department before ordering.



CHILISIN ELECTRONICS CORP.

SMD Wire Wound Ceramic Chip Inductors – CS Series

Electrical Characteristics

Part Number	Inductance (nH)	Tolerance (±%)	Test Frequency (MHz)	Q Min	Test Frequency (MHz)	SRF (MHz) Min	RDC (Ω) Max	Irms (mA) Max	Color
CS0805-R82□-S	820	10 / 5 / 2	25	23	50	215	2.35	180	Blue
CS0805-1R0□-S	1000	10 / 5 / 2	25	20	50	100	2.50	170	Gray
CS0805-1R2□-S	1200	10 / 5	7.9	18	25	100	2.50	170	White
CS0805-1R8□-S	1800	10 / 5 / 2	7.9	16	7.9	80	2.50	170	Orange
CS0805-3R3□-S	3300	10 / 5 / 2	7.9	15	7.9	40	4.40	90	Red
CS0805-4R7□-S	4700	10 / 5 / 2	7.9	15	7.9	40	6.40	90	Yellow

Note: When ordering, please specify tolerance code. Tolerance : G=±2% , J=±5% , K=±10%

- Operating temperature range - 40°C ~ 125°C(Including self - temperature rise)
- I_{rms} for a 15°C temperature rise from 25°C ambient with current
- Measure Equipment :
 L & Q : Agilent E4991A+Agilent HP16197A
 SRF : Agilent HP8753D/Agilent E4991A
 RDC : Chroma 16502
 I_{rms} : HP4284A+HP42841A/HP4285A+HP42841A

Typical L vs. Frequency



Typical Q vs. Frequency



SMD Wire Wound Ceramic Chip Inductors – CS Series

Electrical Characteristics

Part Number	Inductance (nH)	Tolerance (±%)	Test Frequency (MHz)	Q Min	Test Frequency (MHz)	SRF (MHz) Min	RDC (Ω) Max	I _{rms} (mA) Max	Color Coding		
									1 ST	2 ND	3 RD
CS1008-10N□-S	10	10 / 5 / 2	50	50	500	4100	0.08	1000	Brown	Black	Black
CS1008-12N□-S	12	10 / 5 / 2	50	50	500	3300	0.09	1000	Brown	Red	Black
CS1008-15N□-S	15	10 / 5 / 2	50	50	500	2500	0.10	1000	Brown	Green	Black
CS1008-18N□-S	18	10 / 5 / 2	50	50	350	2500	0.11	1000	Brown	Gray	Black
CS1008-22N□-S	22	10 / 5 / 2	50	55	350	2400	0.12	1000	Red	Red	Black
CS1008-27N□-S	27	10 / 5 / 2	50	55	350	1600	0.13	1000	Red	Violet	Black
CS1008-33N□-S	33	10 / 5 / 2	50	60	350	1600	0.14	1000	Orange	Orange	Black
CS1008-39N□-S	39	10 / 5 / 2	50	60	350	1500	0.15	1000	Orange	White	Black
CS1008-47N□-S	47	10 / 5 / 2	50	65	350	1500	0.16	1000	Yellow	Violet	Black
CS1008-56N□-S	56	10 / 5 / 2	50	65	350	1300	0.18	1000	Green	Blue	Black
CS1008-68N□-S	68	10 / 5 / 2	50	65	350	1300	0.20	1000	Blue	Gray	Black
CS1008-82N□-S	82	10 / 5 / 2	50	60	350	1000	0.22	1000	Gray	Red	Black
CS1008-R10□-S	100	10 / 5 / 2	25	60	350	1000	0.56	650	Brown	Black	Brown
CS1008-R12□-S	120	10 / 5 / 2	25	60	350	950	0.63	650	Brown	Red	Brown
CS1008-R15□-S	150	10 / 5 / 2	25	45	100	850	0.70	580	Brown	Green	Brown
CS1008-R18□-S	180	10 / 5 / 2	25	45	100	750	0.77	620	Brown	Gray	Brown
CS1008-R20□-S	200	10 / 5 / 2	25	45	100	700	0.84	500	Red	Black	Brown
CS1008-R22□-S	220	10 / 5 / 2	25	45	100	700	0.84	500	Red	Red	Brown
CS1008-R27□-S	270	10 / 5 / 2	25	45	100	600	0.91	500	Red	Violet	Brown
CS1008-R33□-S	330	10 / 5 / 2	25	45	100	570	1.05	450	Orange	Orange	Brown
CS1008-R39□-S	390	10 / 5 / 2	25	45	100	500	1.12	470	Orange	White	Brown
CS1008-R47□-S	470	10 / 5 / 2	25	45	100	450	1.19	470	Yellow	Violet	Brown
CS1008-R56□-S	560	10 / 5 / 2	25	45	100	415	1.33	400	Green	Blue	Brown
CS1008-R62□-S	620	10 / 5 / 2	25	45	100	375	1.40	300	Blue	Red	Brown
CS1008-R68□-S	680	10 / 5 / 2	25	45	100	375	1.47	400	Blue	Gray	Brown
CS1008-R75□-S	750	10 / 5 / 2	25	45	100	360	1.54	360	Violet	Green	Brown
CS1008-R82□-S	820	10 / 5 / 2	25	45	100	350	1.61	400	Gray	Red	Brown
CS1008-R91□-S	910	10 / 5 / 2	25	35	50	320	1.68	380	White	Brown	Brown
CS1008-1R0□-S	1000	10 / 5 / 2	25	35	50	290	1.75	370	Brown	Black	Red
CS1008-1R2□-S	1200	10 / 5 / 2	7.9	35	50	250	2.0	310	Brown	Red	Red
CS1008-1R5□-S	1500	10 / 5 / 2	7.9	28	50	200	2.3	330	Brown	Green	Red
CS1008-1R8□-S	1800	10 / 5 / 2	7.9	28	50	160	2.6	300	Brown	Gray	Red
CS1008-2R2□-S	2200	10 / 5 / 2	7.9	28	50	160	2.8	280	Red	Red	Red
CS1008-2R7□-S	2700	10 / 5 / 2	7.9	22	25	140	3.2	290	Red	Violet	Red
CS1008-3R3□-S	3300	10 / 5 / 2	7.9	22	25	110	3.4	290	Orange	Orange	Red
CS1008-3R9□-S	3900	10 / 5 / 2	7.9	20	25	100	3.6	260	Orange	White	Red
CS1008-4R7□-S	4700	10 / 5 / 2	7.9	20	25	90	4.0	260	Yellow	Violet	Red
CS1008-5R6□-S	5600	10 / 5 / 2	7.9	18	7.9	45	4.0	240	Green	Blue	Red
CS1008-6R8□-S	6800	10 / 5 / 2	7.9	18	7.9	40	4.9	200	Blue	Gray	Red
CS1008-8R2□-S	8200	10 / 5 / 2	7.9	18	7.9	25	6.0	170	Gray	Red	Red
CS1008-100□-S	10000	10 / 5 / 2	2.52	18	7.9	25	8.0	150	Brown	Black	Orange
CS1008-150□-S	15000	10 / 5 / 2	2.52	15	7.9	20	11	100	Brown	Green	Orange

Note: When ordering, please specify tolerance code. Tolerance : G=±2% , J=±5% , K=±10%

- Operating temperature range - 40°C ~ 125°C(Including self - temperature rise)
- I_{rms} for a 15°C temperature rise from 25°C ambient with current
- Measure Equipment :

L & Q : Agilent E4991A+Agilent HP16197A

SRF : Agilent HP8753D/Agilent E4991A

RDC : Chroma 16502

I_{rms} : HP4284A+HP42841A/HP4285A+HP42841A



COLOR CODING

Please be sure to request approval specifications that provide further details of the products. Kindly note that the content of these specifications are subject to change or may be discontinued without prior notice. This product may not be designed/used in medical or high risk applications without Chilisin approval. Please contact our sales department before ordering.



CHILISIN ELECTRONICS CORP.

SMD Wire Wound Ceramic Chip Inductors – CS Series

Typical **L** vs. **F**requency

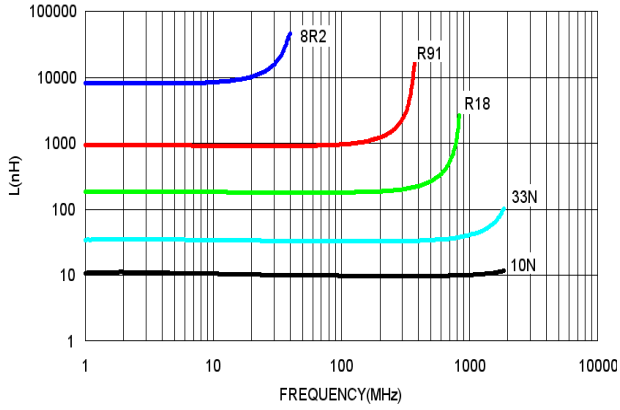

Typical **Q** vs. **F**requency

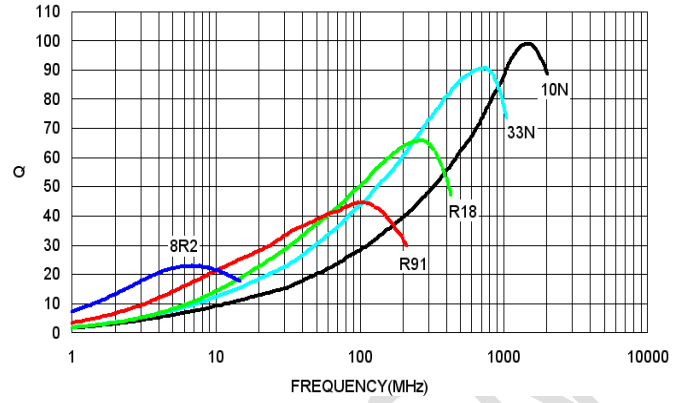

NOT FOR NEW DESIGN

Please be sure to request approval specifications that provide further details of the products. Kindly note that the content of these specifications are subject to change or may be discontinued without prior notice. This product may not be designed/used in medical or high risk applications without Chilisin approval. Please contact our sales department before ordering.

SMD Wire Wound Ceramic Chip Inductors – CS Series

Electrical Characteristics

Part Number	Inductance (uH)	Tolerance (±%)	Test Frequency (MHz)	Q Min	Test Frequency (MHz)	SRF (MHz) Min	RDC (Ω) Max	Irms (mA) Typ
CS1812-1R0□-N	1.0	J	7.9	60	50	310	1.2	480
CS1812-1R2□-N	1.2	J	7.9	62	50	230	1.2	480
CS1812-1R5□-N	1.5	J	7.9	65	50	210	1.6	430
CS1812-1R8□-N	1.8	J	7.9	68	50	190	2.0	380
CS1812-2R2□-N	2.2	J	7.9	63	50	170	2.2	340
CS1812-2R7□-N	2.7	J	7.9	60	50	160	3.2	300
CS1812-3R3□-N	3.3	J	7.9	60	50	145	3.8	270
CS1812-3R9□-N	3.9	J	7.9	61	50	130	5.0	240
CS1812-4R7□-N	4.7	J	7.9	60	50	115	5.4	230
CS1812-5R6□-N	5.6	J	7.9	42	50	100	5.7	220
CS1812-6R8□-N	6.8	J	7.9	32	50	90	6.6	210
CS1812-8R2□-N	8.2	J	7.9	35	50	80	7.0	200
CS1812-100□-N	10	J	7.9	27	50	70	7.7	190
CS1812-120□-N	12	J	2.5	34	10	58	8.7	180
CS1812-150□-N	15	J	2.5	32	10	48	9.6	170
CS1812-180□-N	18	J	2.5	28	10	36	10.5	160
CS1812-220□-N	22	J	2.5	28	10	34	11.5	155
CS1812-270□-N	27	J	2.5	28	10	30	12.5	150
CS1812-330□-N	33	J	2.5	20	10	20	13.5	145

Note: When ordering, please specify tolerance code. Tolerance : J=±5%

- Operating temperature range - 40°C ~ 125°C(Including self - temperature rise)
- Irms for a 15°C temperature rise from 25°C ambient with current
- Measure Equipment :
 L & Q : HP4286A/HP4287A/AgilentE4991/Keysight E4982A
 SRF : Agilent HP8753D/Agilent E4991A
 RDC : Chroma 16502
 Irms : HP4284A+HP42841A/HP4285A+HP42841A

Typical **L** vs. **F** Frequency



Typical **Q** vs. **F** Frequency



Packaging Specifications

Tape Dimensions

Figure 1

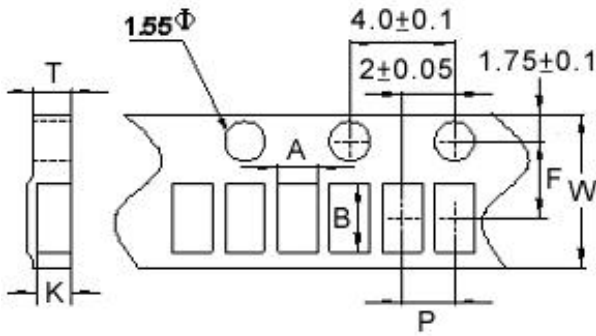

Figure 2

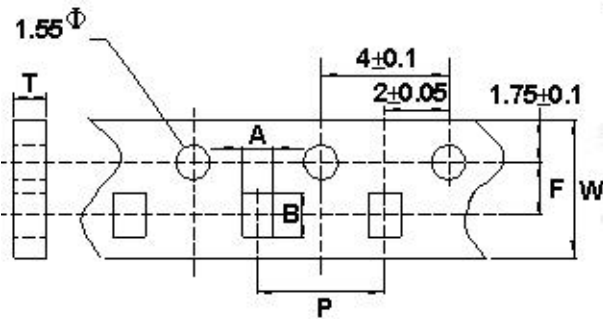
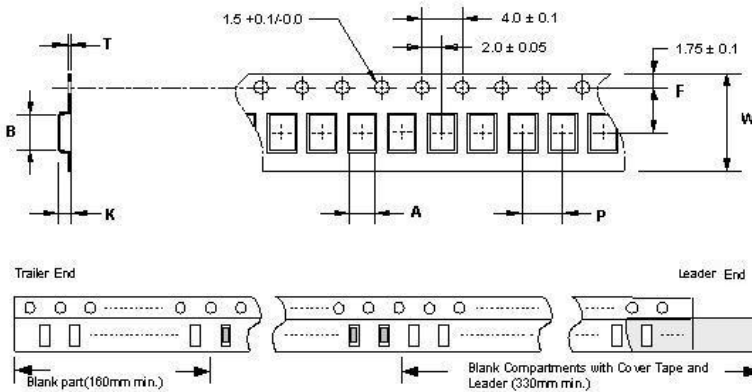
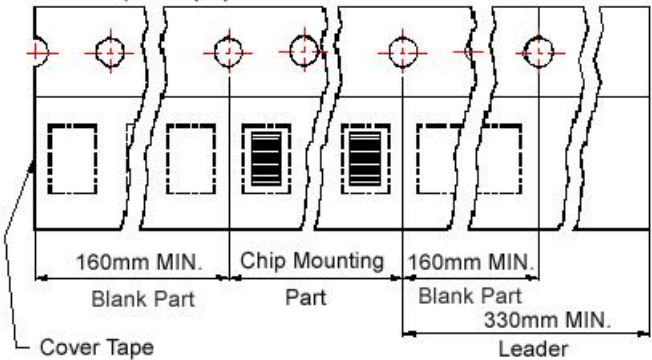

Figure 3



Tape Material

Carrier Tape: Paper
Cover Tape: Polystyrene



Carrier Tape: Paper
Cover Tape: Polystyrene

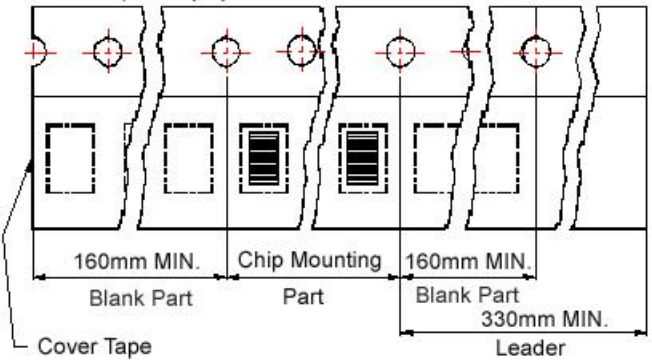

Reel Dimensions

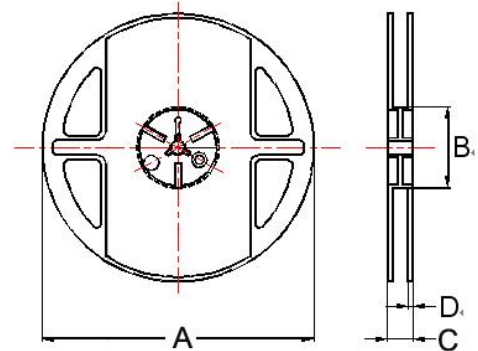

Dimensions in mm

TYPE	Fig.	Tape Dimensions							Reel Dimensions				Quantity PCS / Reel
		A	B	T	W	P	F	K	A	B	C	D	
CS0201	1	0.47	0.60	0.65	8	2	3.5	0.45	178	60	12	1.5	4000
CS0402	1	0.67	1.20	0.75	8	2	3.5	0.59	178	60	12	1.5	4000
CS0603	2	1.25	1.90	1.05	8	4	3.5	-	178	60	12	1.5	4000
CS0805	3	1.85	2.45	0.23	8	4	3.5	1.50	178	60	12	1.5	2000
CS1008	3	2.80	2.95	0.23	8	4	3.5	2.20	178	60	12	1.5	2000
CS1812	3	3.90	4.90	0.30	12	8	5.5	3.20	178	60	16	1.4	600