

Electrical Characteristics

Part Number	Inductance (uH)	Tolerance (±%)	Test Frequency (MHz)	RDC(mΩ) Max(Typ.)	Isat(A) Max(Typ.)	Irms(A) Max(Typ.)
BDCD00201610R24MS1	0.24	20	2	40(28)	4.2(6.0)	4.0(4.5)
BDCD00201610R33MS1	0.33	20	2	48(40)	4.0(5.5)	3.5(3.8)
BDCD00201610R47MS1	0.47	20	2	54(44)	3.2(5.0)	3.0(3.6)
BDCD00201610R56MS1	0.56	20	2	59(46)	2.8(4.6)	2.8(3.3)
BDCD00201610R68MS1	0.68	20	2	72(55)	2.7(4.2)	2.4(3.0)
BDCD002016101R0MS1	1.0	20	2	96(81)	2.2(3.4)	2.0(2.3)
BDCD002016101R5MS1	1.5	20	2	150(122)	2.1(2.8)	1.6(2.0)
BDCD002016102R2MS1	2.2	20	2	204(170)	2.0(2.4)	1.3(1.6)

Note: When ordering, please specify tolerance code. Tolerance: M=±20%

- Operating temperature range - 40°C ~ 125°C(Including self - temperature rise)
- Isat for Inductance drop 30% from its value without current
- Irms for a 40°C temperature rise from 25°C ambient with current
- Rated current : Isat or Irms, whichever is smaller
- Absolute maximum voltage 20VDC
- Measure Equipment :
 L : Agilent E4991/HP4286A+16197A (or equivalent), 2MHz 0.2V
 RDC : CHEN HWA502BC/HP4338B (or equivalent)
 Isat : Agilent E4980A+HP42841A (or equivalent)
 Irms : Agilent 6641 SYSTEM DC POWER SUPPLY (or equivalent)

Test Instruments : E4991A Impedance / Material Analyzer

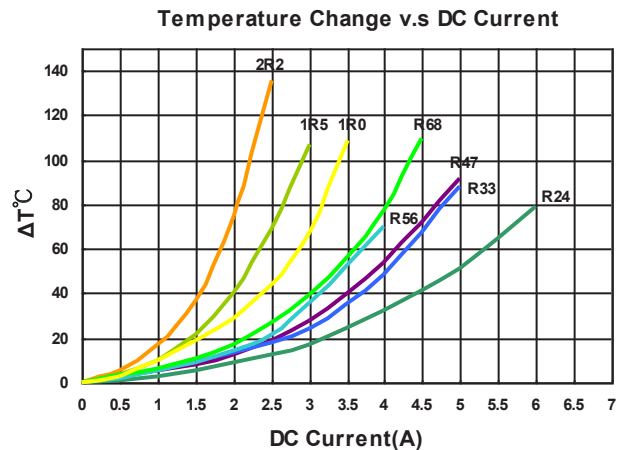
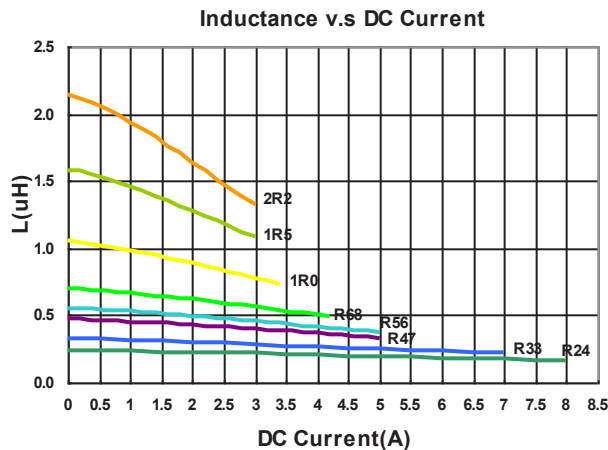

Electrical Characteristics

Part Number	Inductance (uH)	Tolerance (±%)	Test Frequency (MHz)	RDC(mΩ) Max(Typ.)	Isat(A) Max(Typ.)	Irms(A) Max(Typ.)
BDCD00201610R24ML1	0.24	20	2	30(23)	5.0(6.0)	3.8(4.4)
BDCD00201610R33ML1	0.33	20	2	35(27)	4.5(5.0)	3.4(3.8)
BDCD00201610R47ML1	0.47	20	2	41(34)	4.0(4.5)	2.9(3.3)
BDCD00201610R68ML1	0.68	20	2	53(44)	3.3(3.6)	2.5(2.9)
BDCD002016101R0ML1	1.0	20	2	72(60)	2.8(3.2)	2.2(2.5)
BDCD002016101R5ML1	1.5	20	2	110(92)	2.2(2.8)	1.8(2.1)
BDCD002016102R2ML1	2.2	20	2	170(142)	1.8(2.1)	1.5(1.7)

Note: When ordering, please specify tolerance code. Tolerance: M=±20%

- Operating temperature range - 40°C ~ 125°C(Including self - temperature rise)
- Isat for Inductance drop 30% from its value without current
- Irms for a 40°C temperature rise from 25°C ambient with current
- Rated current : Isat or Irms, whichever is smaller
- Absolute maximum voltage 20VDC
- Measure Equipment :
 - L : Agilent E4991/HP4286A+16197A (or equivalent), 2MHz 0.2V
 - RDC : CHEN HWA502BC/HP4338B (or equivalent)
 - Isat : Agilent E4980A+HP42841A (or equivalent)
 - Irms : Agilent 6641 SYSTEM DC POWER SUPPLY (or equivalent)

Test Instruments : E4991A Impedance / Material Analyzer

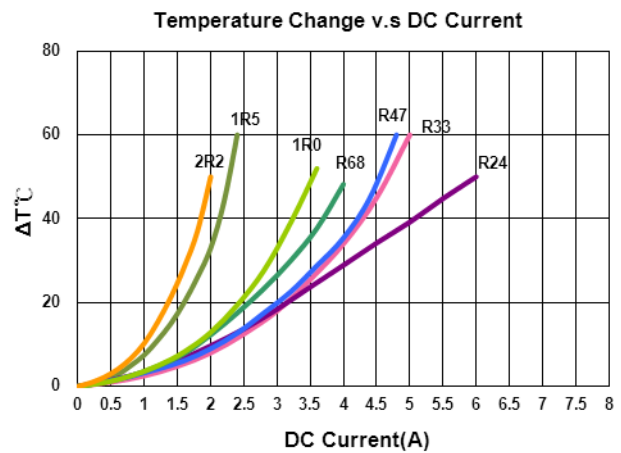
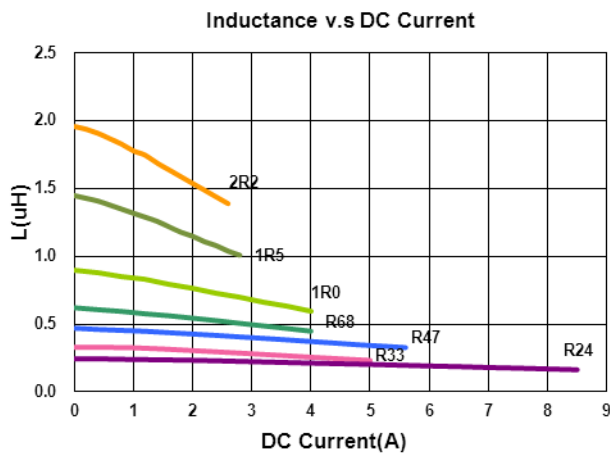

Electrical Characteristics

Part Number	Inductance (uH)	Tolerance (±%)	Test Frequency (MHz)	RDC(mΩ) Max(Typ.)	Isat(A) Max(Typ.)	Irms(A) Max(Typ.)
BDCD00201612R24MS1	0.24	20	2	35(25)	5.5(6.5)	4.2(4.8)
BDCD00201612R47MS1	0.47	20	2	52(40)	3.8(5.1)	3.2(3.8)
BDCD00201612R68MS1	0.68	20	2	70(53)	3.3(4.8)	2.6(3.2)
BDCD002016121R0MS1	1.0	20	2	82(67)	3.1(3.9)	2.3(2.7)
BDCD002016121R5MS1	1.5	20	2	120(95)	2.6(3.2)	2.2(2.6)
BDCD002016122R2MS1	2.2	20	2	195(165)	2.0(2.6)	1.3(1.7)

Note: When ordering, please specify tolerance code. Tolerance: M=±20%

- Operating temperature range - 40°C ~ 125°C(Including self - temperature rise)
- Isat for Inductance drop 30% from its value without current
- I rms for a 40°C temperature rise from 25°C ambient with current
- Rated current : Isat or I rms, whichever is smaller
- Absolute maximum voltage 20VDC
- Measure Equipment :
 - L : Agilent E4991/HP4286A+16197A (or equivalent), 2MHz 0.2V
 - RDC : CHEN HWA502BC/HP4338B (or equivalent)
 - Isat : Agilent E4980A+HP42841A (or equivalent)
 - I rms : Agilent 6641 SYSTEM DC POWER SUPPLY (or equivalent)

Test Instruments : E4991A Impedance / Material Analyzer

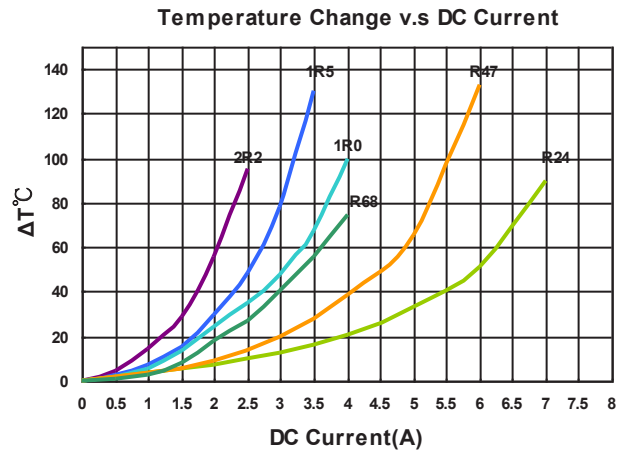
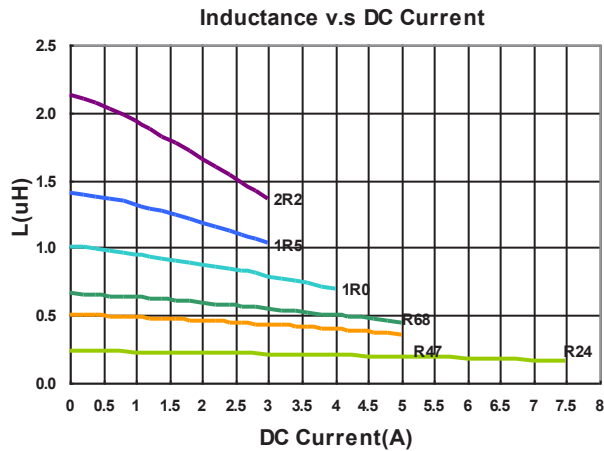

Electrical Characteristics

Part Number	Inductance (uH)	Tolerance (±%)	Test Frequency (MHz)	RDC(mΩ) Max(Typ.)	Isat(A) Max(Typ.)	Irms(A) Max(Typ.)
BDCD00252010R24MS1	0.24	20	2	40(24)	7.5(9.5)	4.5(5.0)
BDCD00252010R47MS1	0.47	20	2	46(36)	5.2(6.5)	3.1(3.6)
BDCD00252010R68MS1	0.68	20	2	65(49)	3.8(5.0)	2.9(3.3)
BDCD002520101R0MS1	1.0	20	2	78(60)	3.4(4.3)	2.5(3.0)
BDCD002520101R5MS1	1.5	20	2	105(82)	3.2(4.0)	2.2(2.9)
BDCD002520102R2MS1	2.2	20	2	156(130)	2.6(3.2)	1.4(1.8)

Note: When ordering, please specify tolerance code. Tolerance: M=±20%

- Operating temperature range - 40°C ~ 125°C(Including self - temperature rise)
- Isat for Inductance drop 30% from its value without current
- Irms for a 40°C temperature rise from 25°C ambient with current
- Rated current : Isat or Irms, whichever is smaller
- Absolute maximum voltage 20VDC
- Measure Equipment :
 - L : Agilent E4991/HP4286A+16197A (or equivalent), 2MHz 0.2V
 - RDC : CHEN HWA502BC/HP4338B (or equivalent)
 - Isat : Agilent E4980A+HP42841A (or equivalent)
 - Irms : Agilent 6641 SYSTEM DC POWER SUPPLY (or equivalent)

Test Instruments : E4991A Impedance / Material Analyzer

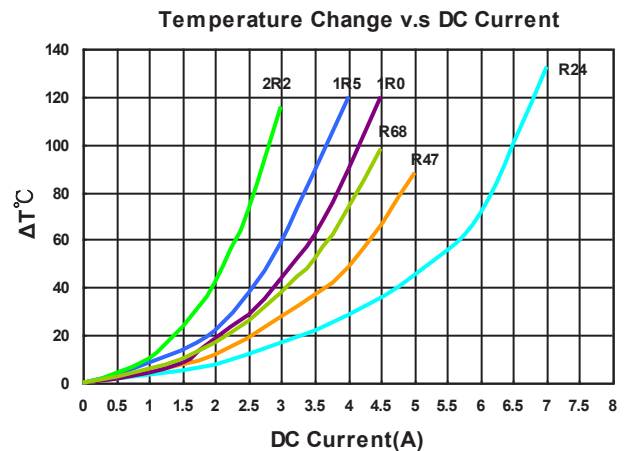
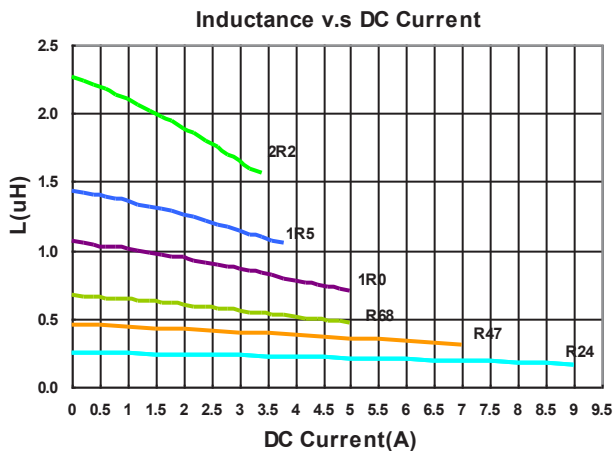

Electrical Characteristics

Part Number	Inductance (uH)	Tolerance (±%)	Test Frequency (MHz)	RDC(mΩ) Max(Typ.)	Isat(A) Max(Typ.)	Irms(A) Max(Typ.)
BDCD00252010R33ML1	0.33	20	2	31(25)	5.0(6.0)	3.8(4.4)
BDCD00252010R47ML1	0.47	20	2	35(29)	4.2(4.7)	3.4(3.9)
BDCD00252010R68ML1	0.68	20	2	48(40)	3.7(4.0)	3.0(3.5)
BDCD002520101R0ML1	1.0	20	2	65(54)	3.2(3.6)	2.6(3.0)
BDCD002520101R5ML1	1.5	20	2	94(78)	2.9(3.3)	2.1(2.4)
BDCD002520102R2ML1	2.2	20	2	120(100)	2.3(2.7)	1.8(2.1)

Note: When ordering, please specify tolerance code. Tolerance: M=±20%

- Operating temperature range - 40°C ~ 125°C(Including self - temperature rise)
- Isat for Inductance drop 30% from its value without current
- I rms for a 40°C temperature rise from 25°C ambient with current
- Rated current : Isat or I rms, whichever is smaller
- Absolute maximum voltage 20VDC
- Measure Equipment :
 L : Agilent E4991/HP4286A+16197A (or equivalent), 2MHz 0.2V
 RDC : CHEN HWA502BC/HP4338B (or equivalent)
 Isat : Agilent E4980A+HP42841A (or equivalent)
 I rms : Agilent 6641 SYSTEM DC POWER SUPPLY (or equivalent)

Test Instruments : E4991A Impedance / Material Analyzer

Inductance v.s DC Current

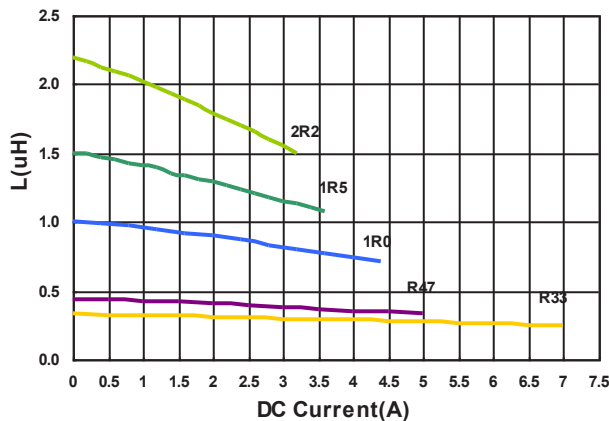

Temperature Change v.s DC Current

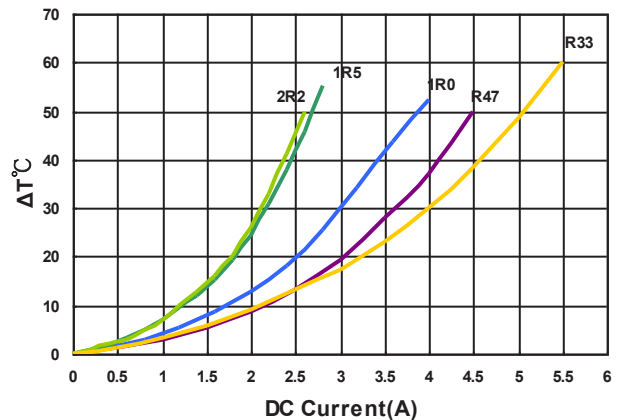

Electrical Characteristics

Part Number	Inductance (uH)	Tolerance (±%)	Test Frequency (MHz)	RDC(mΩ) Max(Typ.)	Isat(A) Max(Typ.)	Irms(A) Max(Typ.)
BDCD00252012R33MS1	0.33	20	2	35(27)	6.8(8.5)	4.0(4.6)
BDCD00252012R47MS1	0.47	20	2	39(29)	6.2(7.8)	3.7(4.4)
BDCD00252012R68MS1	0.68	20	2	46(40)	5.5(6.5)	3.3(3.7)
BDCD002520121R0MS1	1.0	20	2	59(45)	4.0(5.0)	3.0(3.5)
BDCD002520121R5MS1	1.5	20	2	70(62)	3.4(4.0)	2.5(2.7)
BDCD002520122R2MS1	2.2	20	2	115(102)	3.3(3.8)	2.0(2.3)

Note: When ordering, please specify tolerance code. Tolerance: M=±20%

- Operating temperature range - 40°C ~ 125°C(Including self - temperature rise)
- Isat for Inductance drop 30% from its value without current
- I rms for a 40°C temperature rise from 25°C ambient with current
- Rated current : Isat or I rms, whichever is smaller
- Absolute maximum voltage 20VDC
- Measure Equipment :
 - L : Agilent E4991/HP4286A+16197A (or equivalent), 2MHz 0.2V
 - RDC : CHEN HWA502BC/HP4338B (or equivalent)
 - Isat : Agilent E4980A+HP42841A (or equivalent)
 - I rms : Agilent 6641 SYSTEM DC POWER SUPPLY (or equivalent)

Test Instruments : E4991A Impedance / Material Analyzer

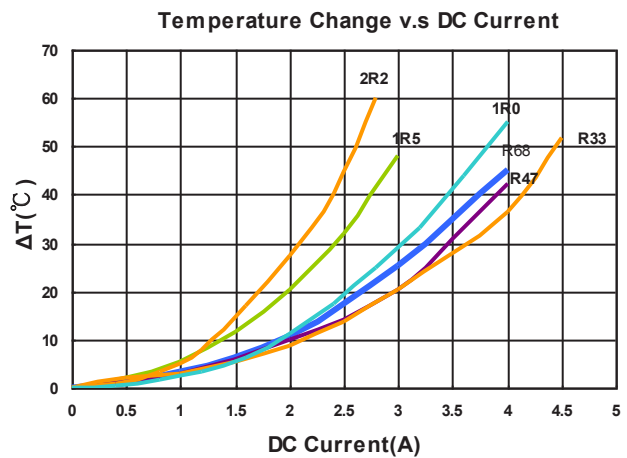
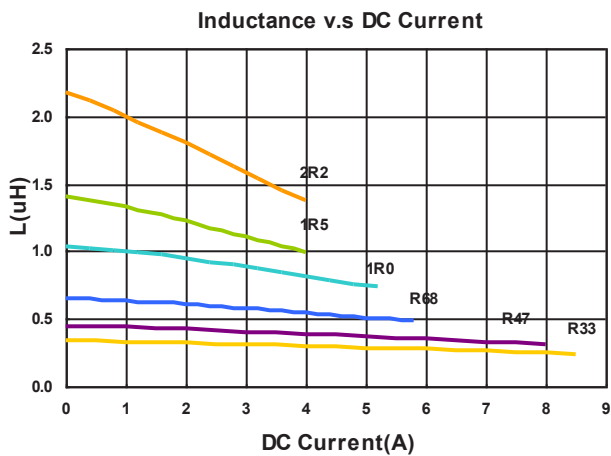

Electrical Characteristics

Part Number	Inductance (uH)	Tolerance (±%)	Test Frequency (MHz)	RDC(mΩ) Max(Typ.)	Isat(A) Max(Typ.)	Irms(A) Max(Typ.)
BDCD00252012R47ML1	0.47	20	2	34(30)	5.2(6.0)	4.1(4.7)
BDCD002520121R0ML1	1.0	20	2	56(45)	3.6(4.5)	3.2(3.7)
BDCD002520122R2ML1	2.2	20	2	102(80)	2.5(3.0)	2.2(2.6)

Note: When ordering, please specify tolerance code. Tolerance: M=±20%

- Operating temperature range - 40°C ~ 125°C(Including self - temperature rise)
- Isat for Inductance drop 30% from its value without current
- I rms for a 40°C temperature rise from 25°C ambient with current
- Rated current : Isat or I rms, whichever is smaller
- Absolute maximum voltage 20VDC
- Measure Equipment :
 - L : Agilent E4991/HP4286A+16197A (or equivalent), 2MHz 0.2V
 - RDC : CHEN HWA502BC/HP4338B (or equivalent)
 - Isat : Agilent E4980A+HP42841A (or equivalent)
 - I rms : Agilent 6641 SYSTEM DC POWER SUPPLY (or equivalent)

Test Instruments : E4991A Impedance / Material Analyzer

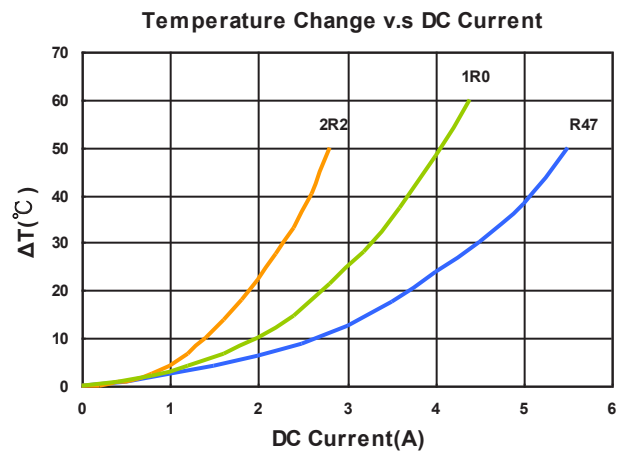
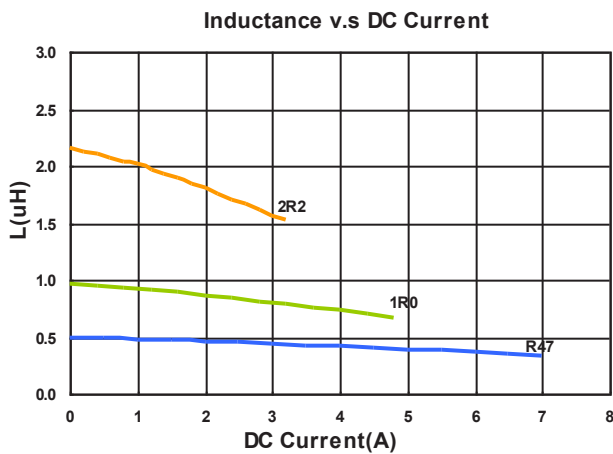

Electrical Characteristics

Part Number	Inductance (uH)	Tolerance (±%)	Test Frequency (MHz)	RDC(mΩ) Max(Typ.)	Isat(A) Max(Typ.)	Irms(A) Max(Typ.)
BDCD00322510R47MS1	0.47	20	2	37(30)	5.8(6.6)	3.6(4.2)
BDCD003225101R0MS1	1.0	20	2	56(49)	4.0(4.6)	3.0(3.3)
BDCD003225101R5MS1	1.5	20	2	75(66)	3.4(4.0)	2.6(3.0)
BDCD003225102R2MS1	2.2	20	2	108(95)	2.7(3.2)	2.2(2.5)

Note: When ordering, please specify tolerance code. Tolerance: M=±20%

- Operating temperature range - 40°C ~ 125°C(Including self - temperature rise)
- Isat for Inductance drop 30% from its value without current
- I rms for a 40°C temperature rise from 25°C ambient with current
- Rated current : Isat or I rms, whichever is smaller
- Absolute maximum voltage 20VDC
- Measure Equipment :
 L : Agilent E4991/HP4286A+16197A (or equivalent), 2MHz 0.2V
 RDC : CHEN HWA502BC/HP4338B (or equivalent)
 Isat : Agilent E4980A+HP42841A (or equivalent)
 I rms : Agilent 6641 SYSTEM DC POWER SUPPLY (or equivalent)

Test Instruments : E4991A Impedance / Material Analyzer

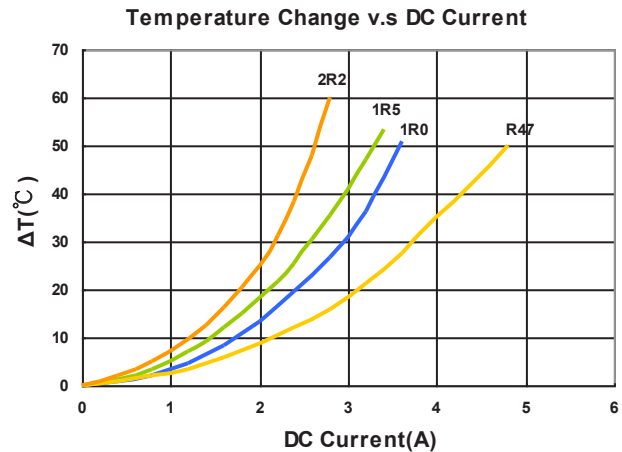
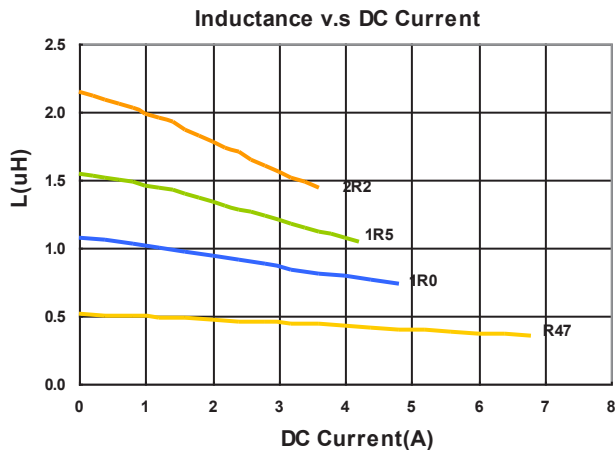

Electrical Characteristics

Part Number	Inductance (uH)	Tolerance (±%)	Test Frequency (MHz)	RDC(mΩ) Max(Typ.)	Isat(A) Max(Typ.)	Irms(A) Max(Typ.)
BDCD00322512R47MS1	0.47	20	2	27(21)	8.0(9.0)	5.0(5.8)
BDCD00322512R68MS1	0.68	20	2	34(26)	6.3(7.5)	4.0(4.6)
BDCD003225121R0MS1	1.0	20	2	42(34)	5.8(6.3)	3.8(4.2)
BDCD003225121R5MS1	1.5	20	2	68(58)	4.0(4.5)	2.8(3.2)
BDCD003225122R2MS1	2.2	20	2	85(75)	3.6(4.0)	2.4(2.7)

Note: When ordering, please specify tolerance code. Tolerance: M=±20%

- Operating temperature range - 40°C ~ 125°C(Including self - temperature rise)
- Isat for Inductance drop 30% from its value without current
- I rms for a 40°C temperature rise from 25°C ambient with current
- Rated current : Isat or I rms, whichever is smaller
- Absolute maximum voltage 20VDC
- Measure Equipment :
 - L : Agilent E4991/HP4286A+16197A (or equivalent), 2MHz 0.2V
 - RDC : CHEN HWA502BC/HP4338B (or equivalent)
 - Isat : Agilent E4980A+HP42841A (or equivalent)
 - I rms : Agilent 6641 SYSTEM DC POWER SUPPLY (or equivalent)

Test Instruments : E4991A Impedance / Material Analyzer

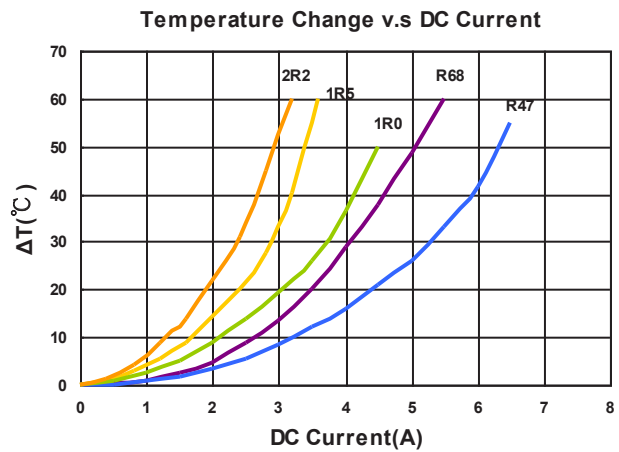
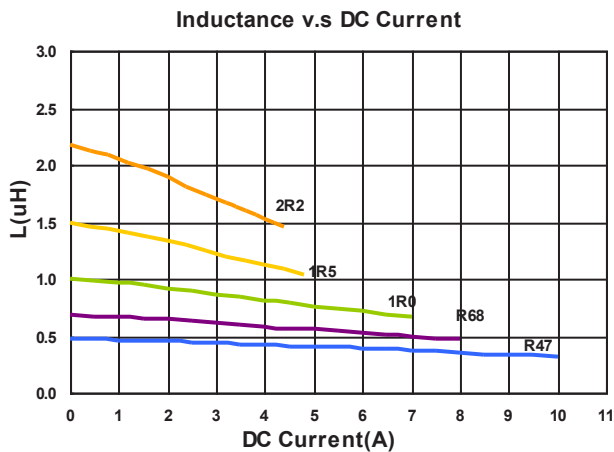

Packaging Specifications

Tape Dimensions

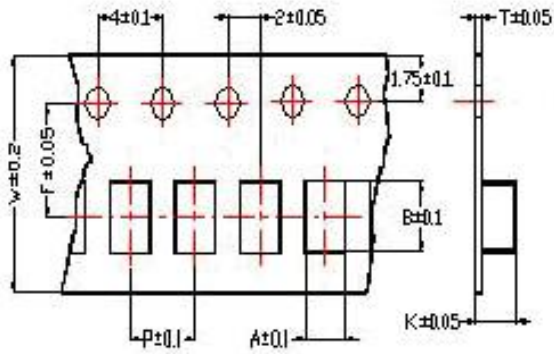

Tape Material

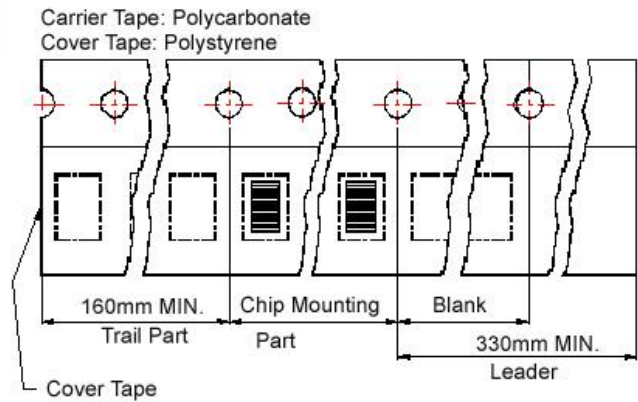

Reel Dimensions

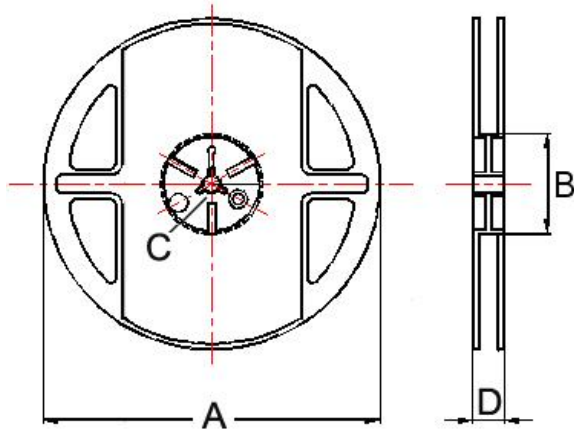

Dimensions in mm

TYPE	Tape Dimensions							Reel Dimensions				Quantity
	A	B	T	W	P	F	K	A	B	C	D	PCS / REEL
BDCD00201610	1.90	2.30	0.22	8	4	3.5	1.15	178	60	12	1.5	3000
BDCD00201612	1.90	2.30	0.22	8	4	3.5	1.15	178	60	12	1.5	3000
BDCD00252010	2.25	2.80	0.22	8	4	3.5	1.15	178	60	12	1.5	3000
BDCD00252012	2.30	2.80	0.22	8	4	3.5	1.35	178	60	12	1.5	3000
BDCD00322510	2.80	3.55	0.23	8	4	3.5	1.20	178	60	12	1.5	3000
BDCD00322512	2.80	3.50	0.23	8	4	3.5	1.34	178	60	12	1.5	3000

For More Information:

Americas - prodinfo_power_americas@yageo.com | Europe - prodinfo_power_emea@yageo.com | Asia - prodinfo_power_asia@yageo.com

Performance warranty of products offered on this data sheet is limited to the parameters specified. Data is subject to change without notice. Other brand and product names mentioned herein may be trademarks or registered trademarks of their respective owners. © Copyright, 2022. Pulse Electronics, Inc. All rights reserved.

单击下面可查看定价，库存，交付和生命周期等信息

[>>CHILISIN\(奇力新\)](#)