

Cautions and Warnings

Please be noted that this spec is only for reference if you have projects designed with the product number listed in. If you are looking for new project design-in, please find BMQx Series specification/datasheet on Chilisin website. Or you may find our sales contact for more information on old part number at your convenience. Appreciated your attention and understanding.

Note: Please be sure to request approval specifications that provide further details of the products. Kindly note that the content of these specifications are subject to change or may be discontinued without prior notice. This product may not be designed/used in medical or high risk applications without Chilisin approval. Please contact our sales department before ordering.

HPPC Series



HPPC series is low profile molding power choke with low RDC and high Q factor, so the efficiency performance is also superior. Its molded magnetic shielded type is suitable for high-density mounting and ultra-low buzz noise. Soldering conditions can be easily confirmed when mounting onto the board. This series also provides customers with embossed carrier type packaging for automatic mounting machine.

Features

- RoHS, Halogen Free and REACH Compliance
- Low RDC
- High Q
- High Efficiency
- Ultra-low buzz noise

Applications

- Laptops and PCs
- Switches and servers
- Base stations
- DC/DC converters

Product Identification

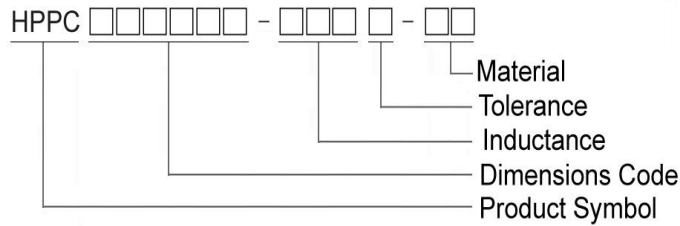

Shape and Dimensions

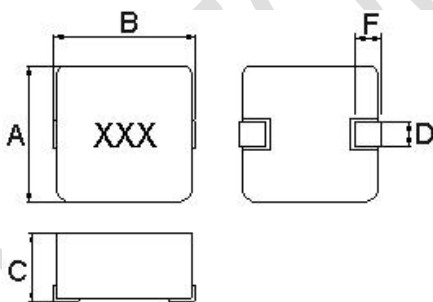

Recommended Pattern

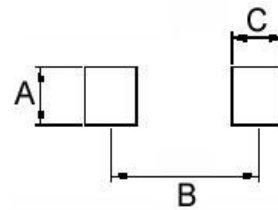

Dimensions in mm

TYPE	A	B	C	D	F
04010	4.1±0.2	4.6±0.2	1.0Max	1.5±0.3	1.0±0.3
04011	4.1±0.2	4.6±0.2	1.1Max	1.5±0.3	1.0±0.3
04020	4.2±0.2	4.8±0.2	1.8±0.2	1.5±0.3	1.1±0.3
05011	5.5±0.2	5.7±0.2	1.1Max	2.0±0.3	1.5±0.3
05030	5.5±0.25	5.85±0.25	2.8±0.2	2.0±0.25	1.5±0.25
06011	6.6±0.2	6.95±0.35	1.1Max	3.0±0.3	1.6±0.3
06020	6.8±0.2	6.95±0.35	1.8±0.2	3.0±0.3	1.6±0.3
06030	6.8±0.2	7.3±0.2	2.8±0.2	3.0±0.3	1.6±0.3
10040	10.2±0.3	11.3±0.3	3.8±0.2	3.0±0.5	2.5±0.5

Dimensions in mm

TYPE	A	B	C
04010	2.5	3.7	1.5
04011	2.5	3.7	1.5
04020	2.5	3.7	1.5
05011	2.5	4.1	1.9
05030	2.5	4.6	1.9
06011	3.5	6.05	2.35
06020	3.5	6.05	2.35
06030	3.5	6.05	2.35
10040	4.0	9.50	3.50

Molding Power Inductors – HPPC Series

Electrical Characteristics

Part Number	Inductance (uH)	Tolerance (±%)	Test Frequency (kHz)	RDC(mΩ) Max(Typ.)	Isat(A) Max(Typ.)	Irms(A) Max(Typ.)	Marking
HPPC04010-R33M-A8	0.33	20	100	14(12)	9.0(11)	6.0(7.0)	R33
HPPC04010-1R0M-A8	1.0	20	100	43(39)	4.0(5.0)	4.0(4.5)	1R0

Note: When ordering, please specify tolerance code. Tolerance: M=±20%

- Operating temperature range - 55°C ~ 125°C(Including self - temperature rise)
- Isat for Inductance drop 30% from its value without current
- I rms for a 40°C temperature rise from 25°C ambient with current
- Absolute maximum voltage 30VDC
- Measure Equipment :
 L : WK 3260B or WK 6500P, 100kHz 0.5V
 RDC : CHEN HWA 502 or CHEN HWA 46502B
 I rms : CHROMA 1810

Test Instruments : WK3260B Impedance / Material Analyzer

Inductance v.s DC Current

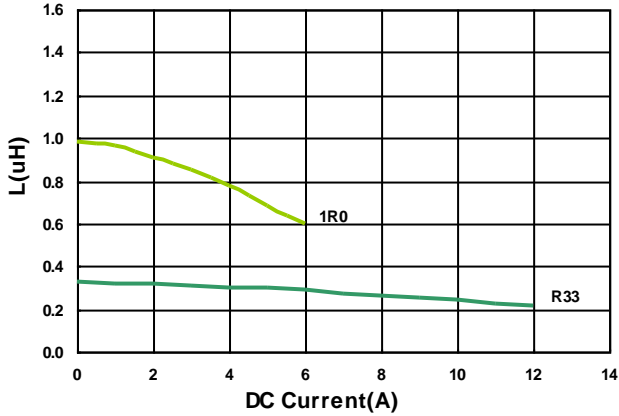

Temperature Change v.s DC Current

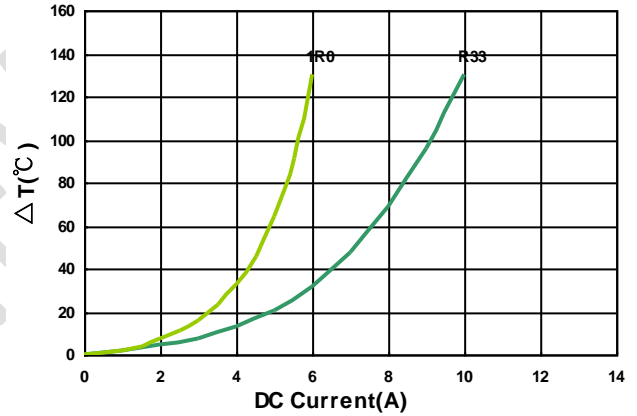

Molding Power Inductors – HPPC Series

Electrical Characteristics

Part Number	Inductance (uH)	Tolerance (±%)	Test Frequency (kHz)	RDC(mΩ) Max(Typ.)	Isat(A) Max(Typ.)	Irms(A) Max(Typ.)	Marking
HPPC04011-1R0M-A8	1.0	20	100	38.5(35)	5.4(6.0)	4.3(4.8)	1R0
HPPC04011-2R2M-A8	2.2	20	100	82(75)	3.5(4.0)	3.0(3.3)	2R2

Note: When ordering, please specify tolerance code. Tolerance: M=±20%

- Operating temperature range - 55°C ~ 125°C(Including self - temperature rise)
- Isat for Inductance drop 30% from its value without current
- I rms for a 40°C temperature rise from 25°C ambient with current
- Absolute maximum voltage 30VDC
- Measure Equipment :
 L : WK 3260B or WK 6500P, 100kHz 0.5V
 RDC : CHEN HWA 502 or CHEN HWA 46502B
 I rms : CHROMA 1810

Test Instruments : WK3260B Impedance / Material Analyzer

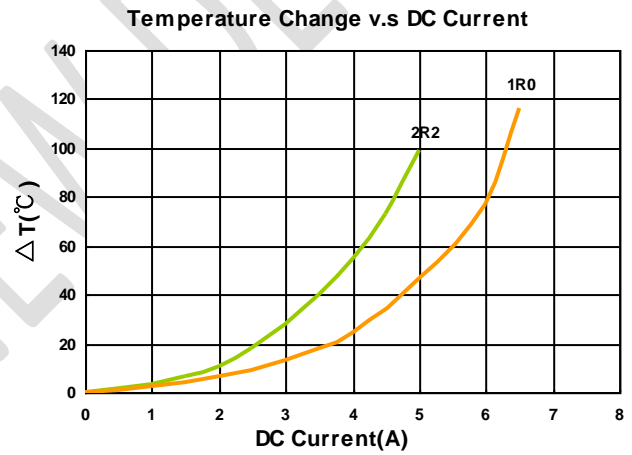
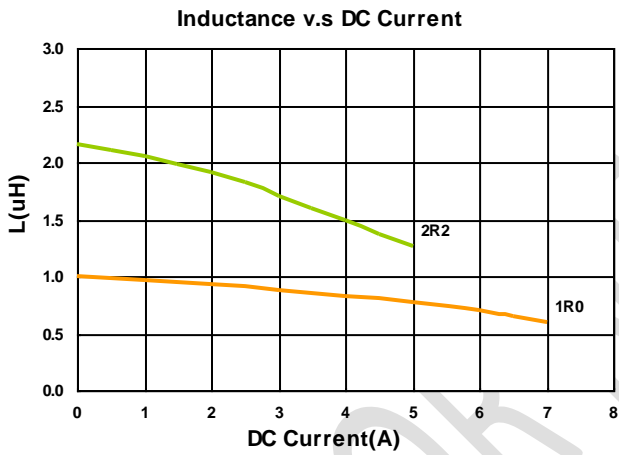

Molding Power Inductors – HPPC Series

Electrical Characteristics

Part Number	Inductance (uH)	Tolerance (±%)	Test Frequency (kHz)	RDC(mΩ) Max(Typ.)	Isat(A) Max(Typ.)	Irms(A) Max(Typ.)	Marking
HPPC04020-R22M-Q8	0.22	20	100	5.5(5.0)	18(20)	10(11)	R22
HPPC04020-1R0M-Q8	1.0	20	100	17(16)	8.0(8.5)	5.5(6.0)	1R0
HPPC04020-2R2M-Q8	2.2	20	100	38.5(35)	6.0(6.5)	4.0(4.5)	2R2
HPPC04020-4R7M-Q8	4.7	20	100	85(77)	4.0(4.5)	2.5(2.8)	4R7

Note: When ordering, please specify tolerance code. Tolerance: M=±20%

- Operating temperature range - 55°C ~ 125°C(Including self - temperature rise)
- Isat for Inductance drop 30% from its value without current
- I rms for a 40°C temperature rise from 25°C ambient with current
- Absolute maximum voltage 30VDC
- Measure Equipment :
 L : WK 3260B or WK 6500P, 100kHz 0.5V
 RDC : CHEN HWA 502 or CHEN HWA 46502B
 I rms : CHROMA 1810

Test Instruments : WK3260B Impedance / Material Analyzer

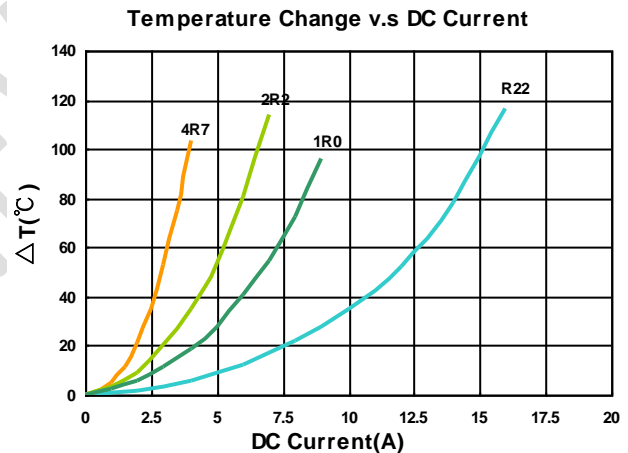
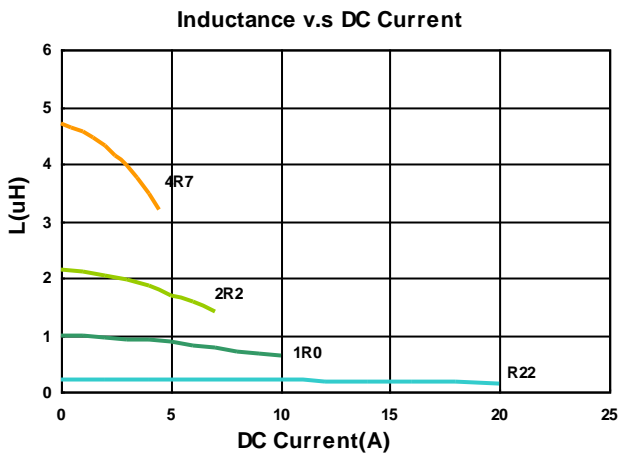

Molding Power Inductors – HPPC Series

Electrical Characteristics

Part Number	Inductance (uH)	Tolerance (±%)	Test Frequency (kHz)	RDC(mΩ) Max(Typ.)	Isat(A) Max(Typ.)	Irms(A) Max(Typ.)	Marking
HPPC05011-1R0M-A8	1.0	20	100	33(30)	7.0(7.5)	4.8(5.3)	1R0

Note: When ordering, please specify tolerance code. Tolerance: M=±20%

- Operating temperature range - 55°C ~ 125°C(Including self - temperature rise)
- Isat for Inductance drop 30% from its value without current
- I rms for a 40°C temperature rise from 25°C ambient with current
- Absolute maximum voltage 30VDC
- Measure Equipment :
 L : WK 3260B or WK 6500P, 100kHz 0.5V
 RDC : CHEN HWA 502 or CHEN HWA 46502B
 I rms : CHROMA 1810

Test Instruments : WK3260B Impedance / Material Analyzer

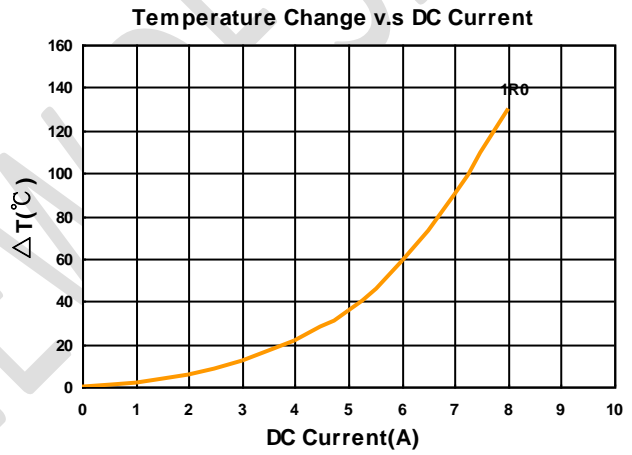
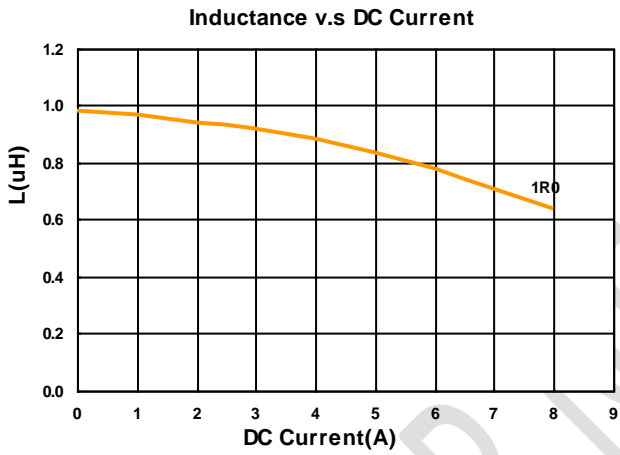

Molding Power Inductors – HPPC Series

Electrical Characteristics

Part Number	Inductance (uH)	Tolerance (±%)	Test Frequency (kHz)	RDC(mΩ) Max(Typ.)	Isat(A) Max(Typ.)	Irms(A) Max(Typ.)	Marking
HPPC05030-R22M-Q8	0.22	20	100	3.90(3.5)	28(32)	18.0(20.0)	R22
HPPC05030-R36M-Q8	0.36	20	100	4.95(4.5)	23(25)	12.5(13.5)	R36
HPPC05030-R68M-Q8	0.68	20	100	6.30(5.7)	17(18)	11.0(12.0)	R68
HPPC05030-1R0M-Q8	1.0	20	100	9.8(8.9)	16(18)	9.00(9.50)	1R0
HPPC05030-1R5M-Q8	1.5	20	100	15(13.5)	12.5(13.5)	7.50(8.0)	1R5
HPPC05030-2R2M-Q8	2.2	20	100	20(18)	11.5(12.5)	6.00(6.5)	2R2
HPPC05030-4R7M-Q8	4.7	20	100	40(37)	6.5(7.50)	4.50(5.0)	4R7

Note: When ordering, please specify tolerance code. Tolerance: M=±20%

- Operating temperature range - 55°C ~ 125°C(Including self - temperature rise)
- Isat for Inductance drop 30% from its value without current
- I rms for a 40°C temperature rise from 25°C ambient with current
- Absolute maximum voltage 30VDC
- Measure Equipment :
 L : WK 3260B or WK 6500P, 100kHz 0.5V
 RDC : CHEN HWA 502 or CHEN HWA 46502B
 I rms : CHROMA 1810

Test Instruments : WK3260B Impedance / Material Analyzer

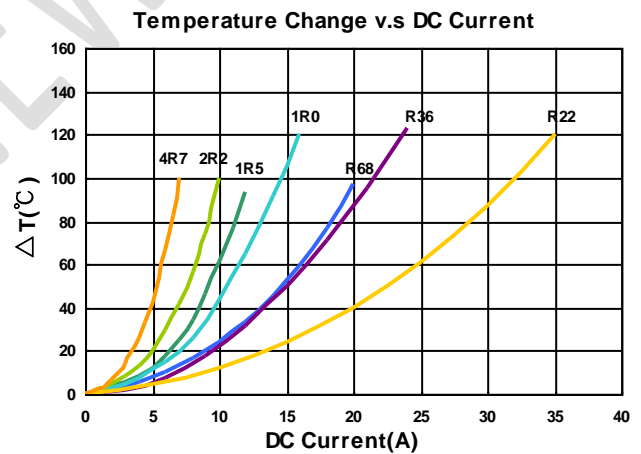
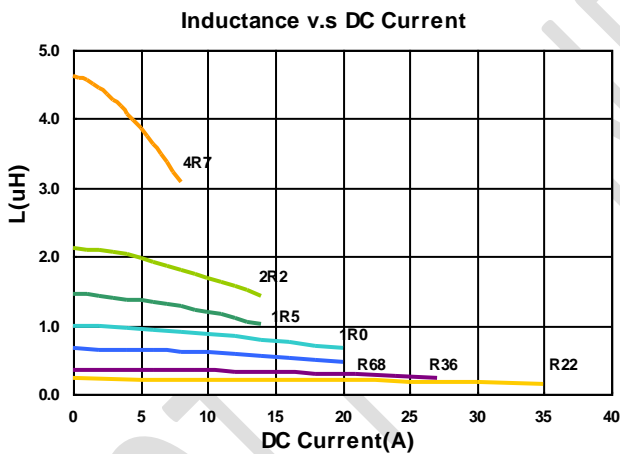

Molding Power Inductors – HPPC Series

Electrical Characteristics

Part Number	Inductance (uH)	Tolerance (±%)	Test Frequency (kHz)	RDC(mΩ) Max(Typ.)	Isat(A) Max(Typ.)	Irms(A) Max(Typ.)	Marking
HPPC06011-1R0M-A8	1.0	20	100	26(24.5)	7.0(7.8)	6.8(7.3)	1R0
HPPC06011-2R2M-A8	2.2	20	100	57(52)	5.0(6.0)	4.2(4.6)	2R2

Note: When ordering, please specify tolerance code. Tolerance: M=±20%

- Operating temperature range - 55°C ~ 125°C(Including self - temperature rise)
- Isat for Inductance drop 30% from its value without current
- I rms for a 40°C temperature rise from 25°C ambient with current
- Absolute maximum voltage 30VDC
- Measure Equipment :
 L : WK 3260B or WK 6500P, 100kHz 0.5V
 RDC : CHEN HWA 502 or CHEN HWA 46502B
 I rms : CHROMA 1810

Test Instruments : WK3260B Impedance / Material Analyzer

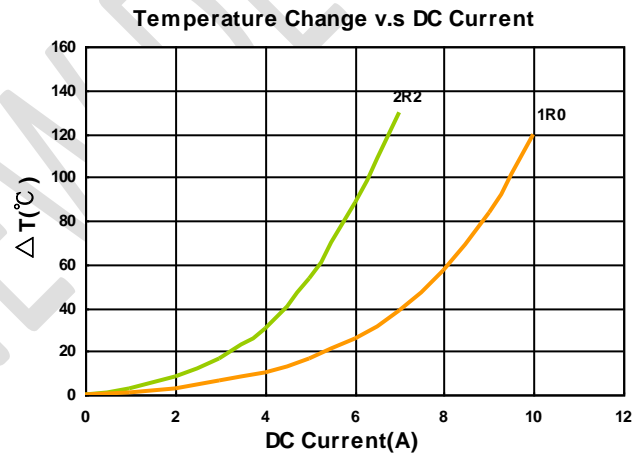
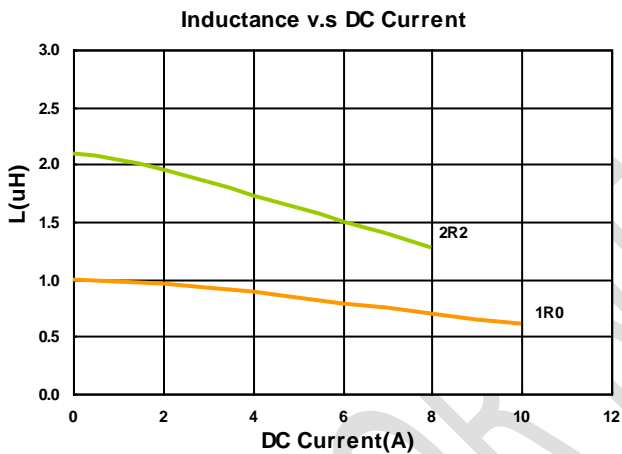

Electrical Characteristics

Part Number	Inductance (uH)	Tolerance (±%)	Test Frequency (kHz)	RDC(mΩ) Max(Typ.)	Isat(A) Max(Typ.)	Irms(A) Max(Typ.)	Marking
HPPC06020-4R7M-Q8	4.7	20	100	48(43.7)	6.0(6.8)	4.2(4.7)	4R7

Note: When ordering, please specify tolerance code. Tolerance: M=±20%

- Operating temperature range - 55°C ~ 125°C(Including self - temperature rise)
- Isat for Inductance drop 30% from its value without current
- I rms for a 40°C temperature rise from 25°C ambient with current
- Absolute maximum voltage 30VDC
- Measure Equipment :
 L : WK 3260B or WK 6500P, 100kHz 0.5V
 RDC : CHEN HWA 502 or CHEN HWA 46502B
 I rms : CHROMA 1810

Test Instruments : WK3260B Impedance / Material Analyzer

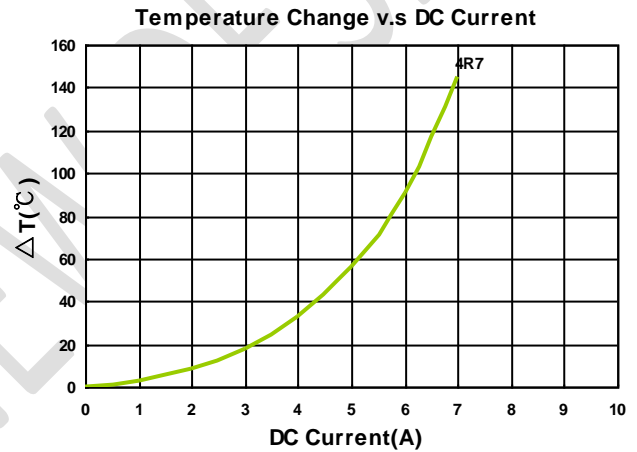
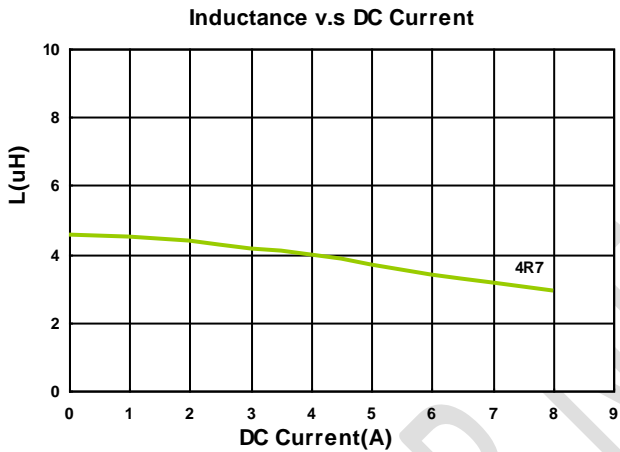

Molding Power Inductors – HPPC Series

Electrical Characteristics

Part Number	Inductance (uH)	Tolerance (±%)	Test Frequency (kHz)	RDC(mΩ) Max(Typ.)	Isat(A) Max(Typ.)	Irms(A) Max(Typ.)	Marking
HPPC06030-R22M-Q8	0.22	20	100	2.0(1.8)	35(40)	25(27)	R22
HPPC06030-R36M-Q8	0.36	20	100	2.6(2.3)	27(32)	23(25)	R36
HPPC06030-R47M-Q8	0.47	20	100	3.3(2.9)	25(27)	19(20)	R47
HPPC06030-R56M-Q8	0.56	20	100	3.9(3.5)	23(25)	17(18)	R56
HPPC06030-R68M-Q8	0.68	20	100	4.2(3.8)	18(20)	16(17)	R68
HPPC06030-1R0M-Q8	1.0	20	100	5.3(4.8)	17(19)	14(15)	1R0
HPPC06030-1R5M-Q8	1.5	20	100	7.7(7.0)	15(17)	11(11.5)	1R5
HPPC06030-2R2M-Q8	2.2	20	100	9.4(8.5)	12(12.5)	10.5(11)	2R2
HPPC06030-3R3M-Q8	3.3	20	100	15(13.5)	9.0(9.5)	8.0(8.5)	3R3
HPPC06030-4R7M-Q8	4.7	20	100	22.0(20)	6.5(7.0)	6.0(6.5)	4R7
HPPC06030-6R8M-Q8	6.8	20	100	38.5(35)	6.0(6.5)	5.3(5.8)	6R8
HPPC06030-8R2M-Q8	8.2	20	100	47.0(43)	5.5(6.0)	5.0(5.4)	8R2
HPPC06030-100M-Q8	10	20	100	47.0(43)	5.0(5.5)	4.8(5.3)	100

Note: When ordering, please specify tolerance code. Tolerance: M=±20%

- Operating temperature range - 55°C ~ 125°C(Including self - temperature rise)
- Isat for Inductance drop 30% from its value without current
- I rms for a 40°C temperature rise from 25°C ambient with current
- Absolute maximum voltage 30VDC
- Measure Equipment :
 L : WK 3260B or WK 6500P, 100kHz 0.5V
 RDC : CHEN HWA 502 or CHEN HWA 46502B
 I rms : CHROMA 1810

Test Instruments : WK3260B Impedance / Material Analyzer

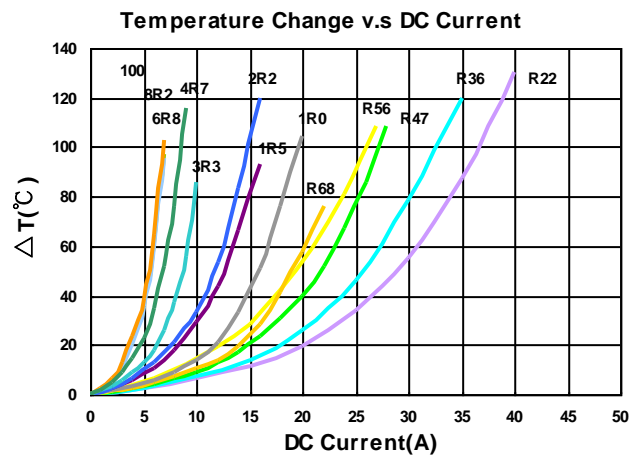
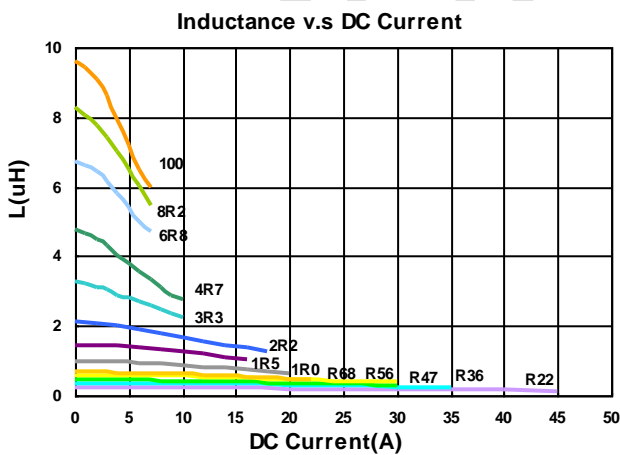

Molding Power Inductors – HPPC Series

Electrical Characteristics

Part Number	Inductance (uH)	Tolerance (±%)	Test Frequency (kHz)	RDC(mΩ) Max(Typ.)	Isat(A) Max(Typ.)	Irms(A) Max(Typ.)	Marking
HPPC10040-R22M-Q8	0.22	20	100	0.54(0.45)	55(60)	40(42)	R22
HPPC10040-R33M-Q8	0.33	20	100	0.68(0.62)	45(50)	32(35)	R33
HPPC10040-R56M-Q8	0.56	20	100	1.2(1.0)	40(45)	28(30)	R56
HPPC10040-R68M-Q8	0.68	20	100	1.5(1.3)	32(37)	25(27)	R68
HPPC10040-1R0M-Q8	1.0	20	100	2.4(2.2)	26(30)	23(25)	1R0
HPPC10040-2R2M-Q8	2.2	20	100	4.7(4.3)	17(20)	15(15.6)	2R2
HPPC10040-3R3M-Q8	3.3	20	100	7.9(7.2)	16(18)	12(12.5)	3R3
HPPC10040-4R7M-Q8	4.7	20	100	10.5(9.5)	13(14)	10.5(11)	4R7
HPPC10040-6R8M-Q8	6.8	20	100	16.5(15)	9.0(10)	8.5(9.0)	6R8
HPPC10040-100M-Q8	10	20	100	24(22)	8.5(9.0)	8.0(8.5)	100

Note: When ordering, please specify tolerance code. Tolerance: M=±20%

- Operating temperature range - 55°C ~ 125°C(Including self - temperature rise)
- Isat for Inductance drop 30% from its value without current
- I rms for a 40°C temperature rise from 25°C ambient with current
- Absolute maximum voltage 30VDC
- Measure Equipment :
 - L : WK 3260B or WK 6500P, 100kHz 0.5V
 - RDC : CHEN HWA 502 or CHEN HWA 46502B
 - I rms : CHROMA 1810

Test Instruments : WK3260B Impedance / Material Analyzer

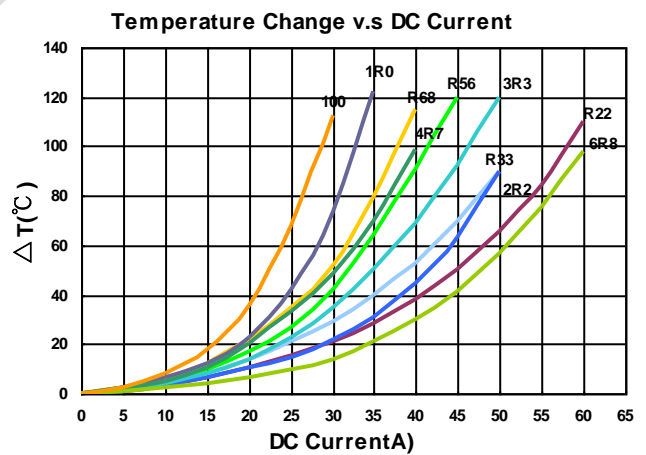
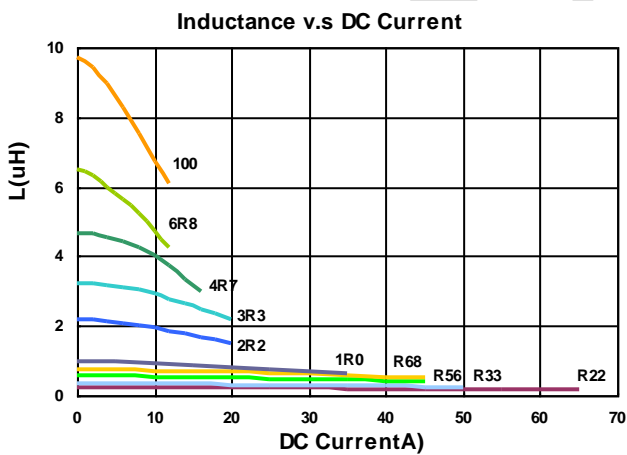

Packaging Specifications

Tape Dimensions

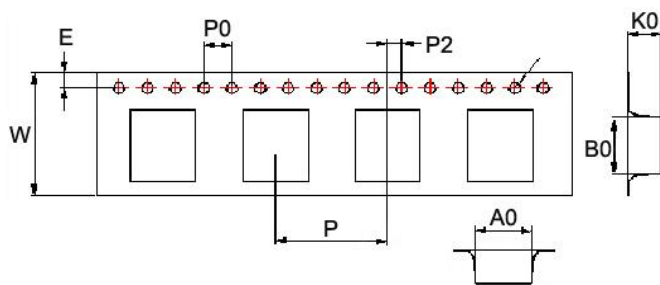

Tape Material

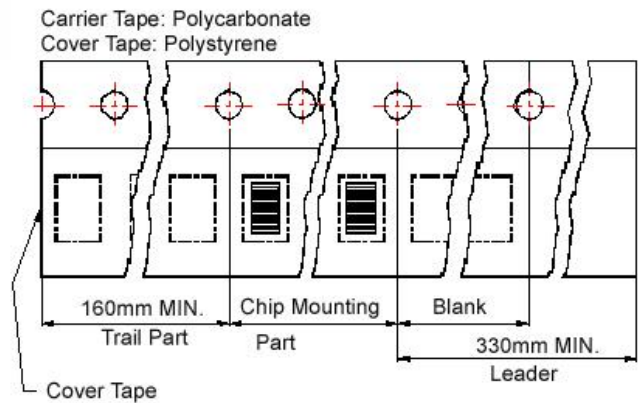

Reel Dimensions

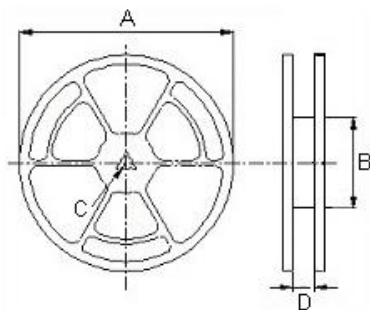

Dimensions in mm

TYPE	Tape Dimensions									Reel Dimensions				Quantity PCS / REEL
	A0	B0	K0	D	E	W	P	P0	P2	A	B	C	D	
04010	4.4	4.9	1.4	1.55	1.75	12	8	4	2	330	100	13	13.4	2000
04011	4.4	4.9	1.5	1.55	1.75	12	8	4	2	330	100	13	13.4	2000
04020	4.5	5.1	2.4	1.55	1.75	12	8	4	2	330	100	13	13.4	2000
05011	5.9	6.2	1.5	1.55	1.75	16	12	4	2	330	100	13	16	2000
05030	5.9	6.25	3.4	1.55	1.75	16	12	4	2	330	100	13	16	1000
06011	6.9	7.4	1.5	1.55	1.75	16	12	4	2	330	100	13	16	1000
06020	7.05	7.6	2.4	1.55	1.75	16	12	4	2	330	100	13	16	1000
06030	7.0	7.6	3.4	1.55	1.75	16	12	4	2	330	100	13	16	1000
10040	10.6	11.7	4.25	1.55	1.75	24	16	4	2	330	100	13	24.4	500

单击下面可查看定价，库存，交付和生命周期等信息

[>>CHILISIN\(奇力新\)](#)