

## Specifications

- Current rating:7A AC,DC
- Voltage rating:250V AC,DC
- Temperature range:-40°C~+105°C
- Contact resistance:10mΩMax.
- Insulation resistance:1000MΩMin.
- Withstanding voltage:1500V AC/minute
- \*Compliant with RoHS and REACH\*
- \*Meet the HF/Halogen Free,GWT/Glow wire Test (IEC60335-1) request,need to customize\*
- \*Contact CJT for details\*

## Standards

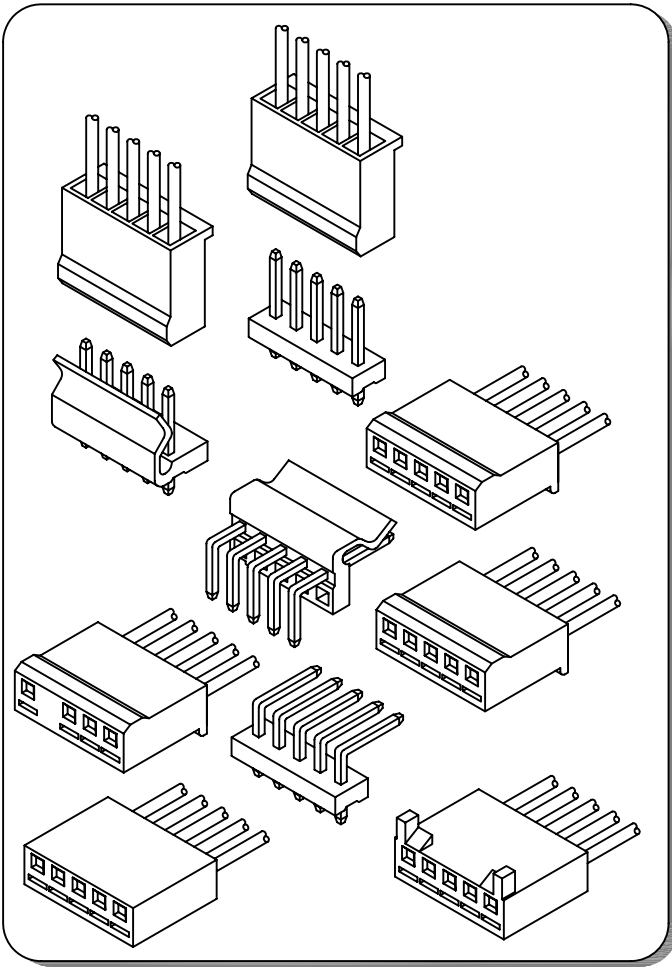

## Assembly layout

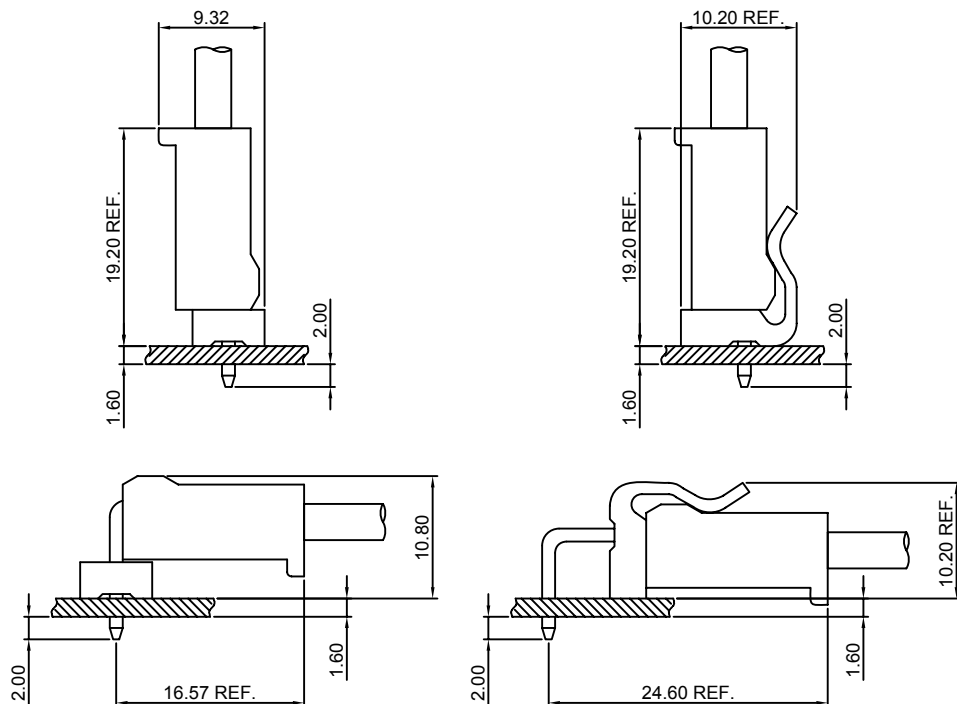

## A3964-T

3.96mm pitch Crimp Terminal

### Reference Informations:

\*Used in CJT A3964H-XP, A3964H-XP-A, A3964H-XP-B, A3964H-XP-C, A5082H-XP, A5082H-XP-A, A7501H-XP series Housing

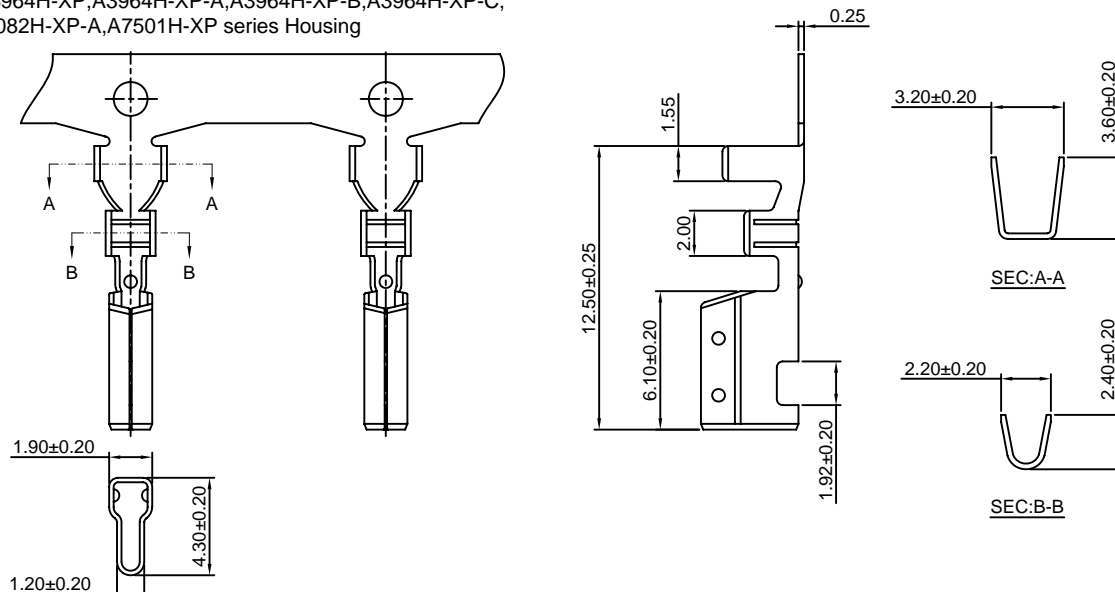

Ordering information & Specifications:

Unit:mm

Part NO.	Wire Range	Insulation O.D.	Material	Finish	Qty/reel
A3964-TB	AWG#18-#24	3.20mm(max)	Brass	Tin over Nickel	5,000 PCS
A3964-TP	AWG#18-#24	3.20mm(max)	Phosphor Bronze	Tin over Nickel	5,000 PCS
A3964-GB	AWG#18-#24	3.20mm(max)	Brass	Gold over Nickel	5,000 PCS
A3964-GP	AWG#18-#24	3.20mm(max)	Phosphor Bronze	Gold over Nickel	5,000 PCS

Optional Gold plating available but MOQ requested

## A3964-T-L

3.96mm pitch Crimp Terminal

### Reference Informations:

\*Used in CJT A3964H-XP, A3964H-XP-A, A3964H-XP-B, A3964H-XP-C, A5082H-XP, A5082H-XP-A, A7501H-XP series Housing

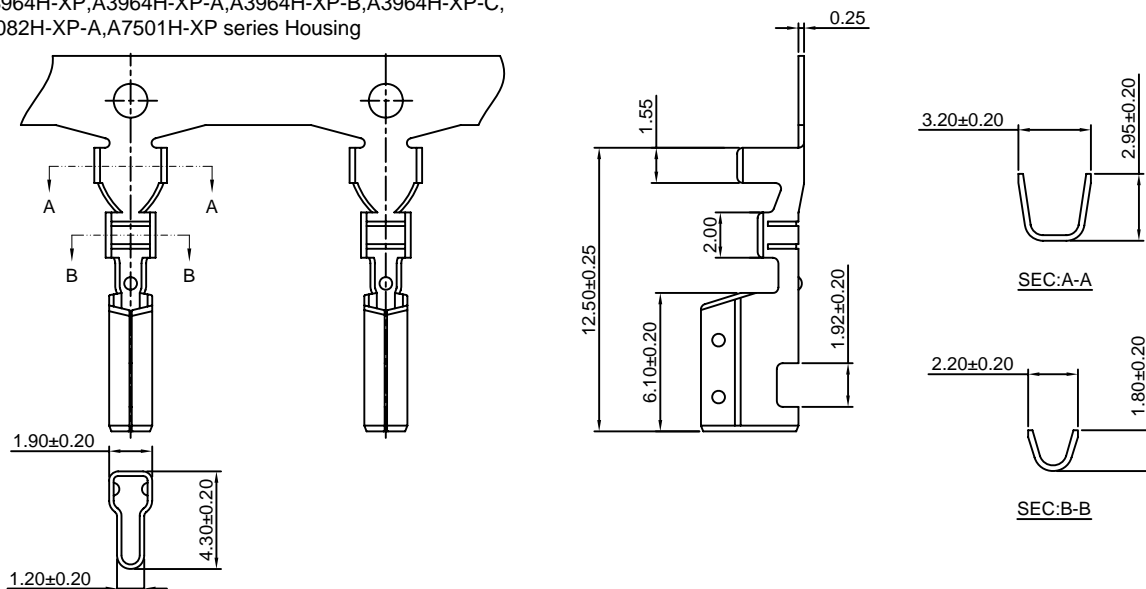

Ordering information & Specifications:

Unit:mm

Part NO.	Wire Range	Insulation O.D.	Material	Finish	Qty/reel
A3964-TB-L	AWG#22-#28	2.60mm(max)	Brass	Tin over Nickel	5,000 PCS
A3964-TP-L	AWG#22-#28	2.60mm(max)	Phosphor Bronze	Tin over Nickel	5,000 PCS
A3964-GB-L	AWG#22-#28	2.60mm(max)	Brass	Gold over Nickel	5,000 PCS
A3964-GP-L	AWG#22-#28	2.60mm(max)	Phosphor Bronze	Gold over Nickel	5,000 PCS

Optional Gold plating available but MOQ requested

### A3964H-XP

3.96mm pitch Housing

**Reference Informations:**

- \*Material: Nylon 66, UL94V-2
- \*Suitable CJT A3964-T(-L) series Terminal
- \*Mates with CJT A3961WV, WR, WVA, WRA-XP(-A), A3961WV, WVA-XP-R(-A), A3961WVB-F, WRB-F-XP, A3961WVB, WRB, WVC, WRC-XP series Wafer
- \*Color: Natural

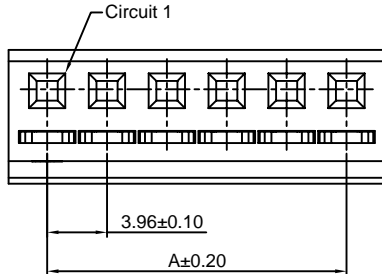

**Ordering Information:**

A3964H-XP - \*\*\*  
1 2

- 1. Part No.
- 2. Material:  
(blank): Nylon 66, UL94V-2  
V0: Nylon 66, UL94V-0  
GWT: Nylon 66, UL94V-0, GWT 750°C

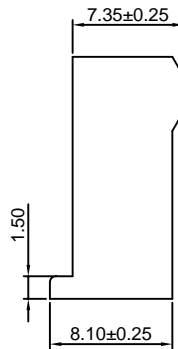
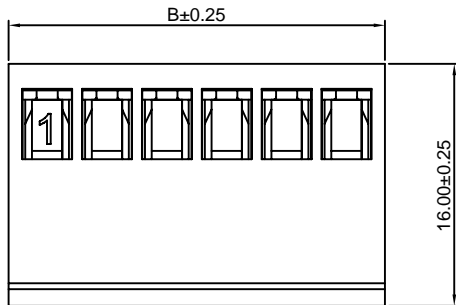
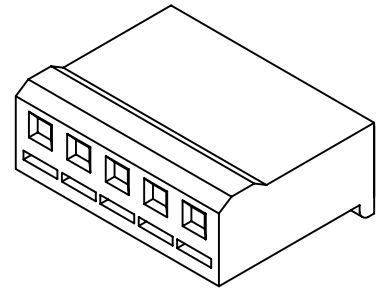

**Ordering Information & Dimensions:**

PART NO.	Dimensions	
	A	B
2P	3.96	9.06
3P	7.92	13.02
4P	11.88	16.98
5P	15.84	20.94
6P	19.80	24.90
7P	23.76	28.86
8P	27.72	32.82
9P	31.68	36.78
10P	35.64	40.74
11P	39.60	44.70
12P	43.56	48.66

Unit: mm

### A3964H-XP-A

7.92~3.96mm pitch Housing

**Reference Informations:**

- \*Material: Nylon 66, UL94V-2
- \*Suitable CJT A3964-T(-L) series Terminal
- \*Mates with CJT A3961WV, WR, WVA, WRA-XP(-A), A3961WV, WVA-XP-R(-A), A3961WVB-F, WRB-F-XP, A3961WVB, WRB, WVC, WRC-XP series Wafer
- \*Color: Natural

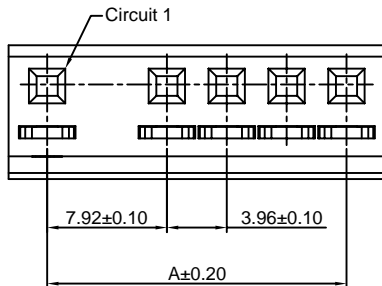

**Ordering Information:**

A3964H-XP-A - \*\*\*  
1 2

- 1. Part No.
- 2. Material:  
(blank): Nylon 66, UL94V-2  
V0: Nylon 66, UL94V-0  
GWT: Nylon 66, UL94V-0, GWT 750°C

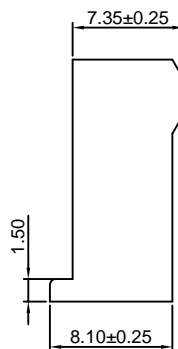
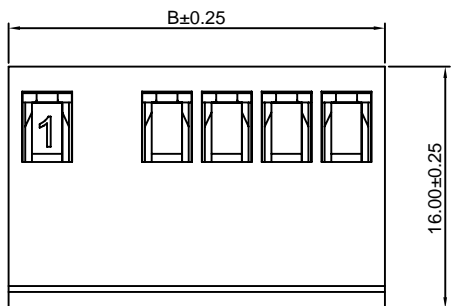
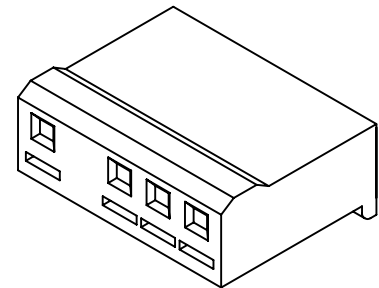

**Ordering Information & Dimensions:**

PART NO.	Dimensions	
	A	B
3P	7.92	13.02
4P	11.88	16.98
5P	15.84	20.94
6P	19.80	24.90
7P	23.76	28.86
8P	27.72	32.82
9P	31.68	36.78
10P	35.64	40.74
11P	39.60	44.70
12P	43.56	48.66

Unit: mm

## A3964H-XP-B

3.96mm pitch Housing

**Reference Informations:**

- \*Material:Nylon 66,UL94V-0
- \*Suitable CJT A3964-T(-L) series Terminal
- \*Mates with CJT A3961WVA,WRA-XP(-A), A3961WVA-XP-R(-A),A3961WVB-F,WRB-F-XP, A3961WVB,WRB-XP,A3961WRB-F-L-XP series Wafer
- \*Color:White

**Ordering Information:**

- A3964H-XP-B - \*\*\* - \*\*
- |   |   |   |
|---|---|---|
| 1 | 2 | 3 |
|---|---|---|
- 1.Part No.
  - 2.Material:  
(blank):Nylon 66,UL94V-0  
GWT:Nylon 66,UL94V-0,GWT 750°C
  - 3.Color:  
(blank):White  
BK:Black

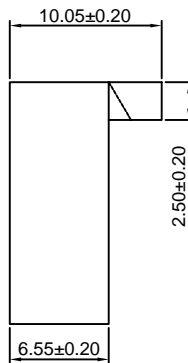
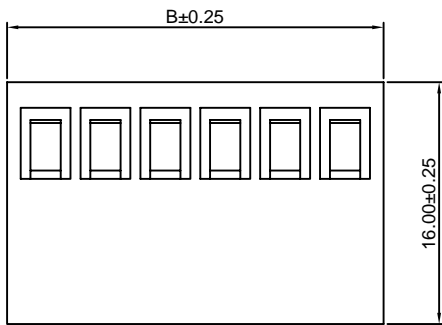
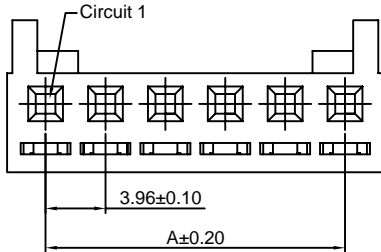
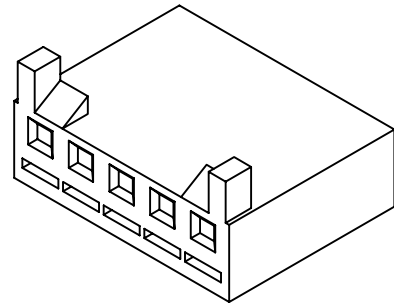

**Ordering Information & Dimensions:**

PART NO.	Dimensions	
	A	B
2P	3.96	9.06
3P	7.92	13.02
4P	11.88	16.98
5P	15.84	20.94
6P	19.80	24.90
7P	23.76	28.86
8P	27.72	32.82
9P	31.68	36.78
10P	35.64	40.74
11P	39.60	44.70
12P	43.56	48.66

Unit: mm

## A3964H-XP-C

3.96mm pitch Housing

**Reference Informations:**

- \*Material:Nylon 66,UL94V-0
- \*Suitable CJT A3964-T(-L) series Terminal
- \*Mates with CJT A3961WV,WR,WVA,WRA-XP(-A), A3961WV,WVA-XP-R(-A),A3961WVB-F,WRB-F-XP, A3961WVB,WRB,WVC,WRC-XP series Wafer
- \*Color:White

**Ordering Information:**

- A3964H-XP-C - \*\*\* - \*\*
- |   |   |   |
|---|---|---|
| 1 | 2 | 3 |
|---|---|---|
- 1.Part No.
  - 2.Material:  
(blank):Nylon 66,UL94V-0  
GWT:Nylon 66,UL94V-0,GWT 750°C
  - 3.Color:  
(blank):White  
BK:Black

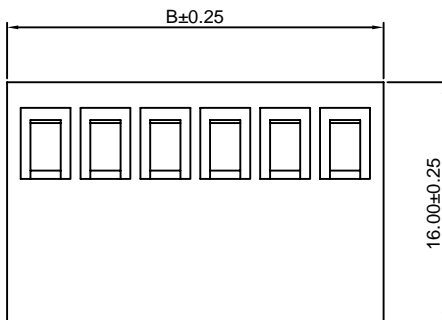
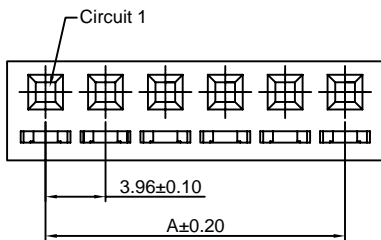
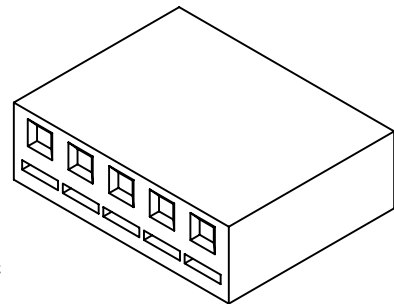

**Ordering Information & Dimensions:**

PART NO.	Dimensions	
	A	B
2P	3.96	9.06
3P	7.92	13.02
4P	11.88	16.98
5P	15.84	20.94
6P	19.80	24.90
7P	23.76	28.86
8P	27.72	32.82
9P	31.68	36.78
10P	35.64	40.74
11P	39.60	44.70
12P	43.56	48.66

Unit: mm

单击下面可查看定价，库存，交付和生命周期等信息

[>>CJT\(长江连接器\)](#)