

## Specifications

- Current rating: 5.5A AC, DC (Max)
- Voltage rating: 250V AC, DC
- Temperature range: -40°C ~ +105°C
- Contact resistance: 10mΩ Max.
- Insulation resistance: 1000MΩ Min.
- Withstanding voltage: 1500V AC/minute
- \*Compliant with RoHS and REACH\*
- \*Meet the HF/Halogen Free, GWT/Glow wire Test (IEC60335-1) request, need to customize\*
- \*Contact CJT for details\*

## Standards



## Assembly layout

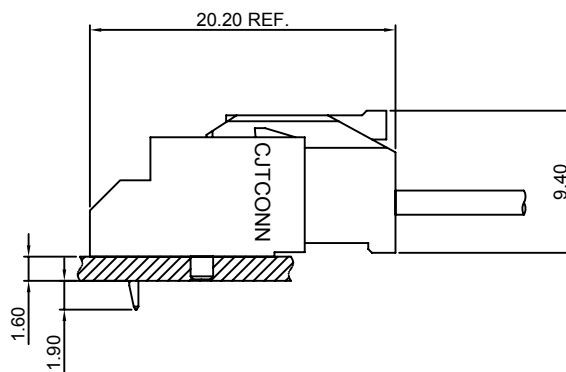
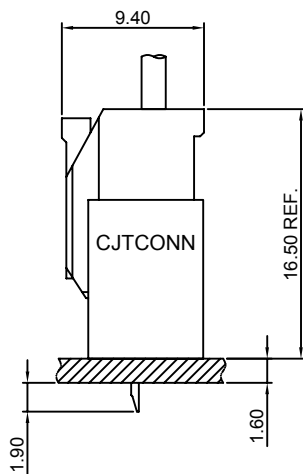

### A3502H-XP

3.50mm Pitch Housing

**Reference Informations:**

- \*Material:Nylon 66,UL94V-0
- \*Suitable CJT A3965-T series Terminal
- \*Mates with CJT A3502WV,WR-XP(-A) series Wafer
- \*Color:White

**Ordering Information:**

- A3502H-XP - \*\*\* - \*\*  
 1 2 3
- 1.Part No.
  - 2.Material:  
 (blank):Nylon 66,UL94V-0  
 PBT:PBT,UL94V-0  
 GWT:Nylon 66,UL94V-0,GWT 750°C
  - 3.Color:  
 (blank):White  
 BK:Black  
 RD:Red  
 YL:Yellow  
 BL:Blue  
 GN:Green

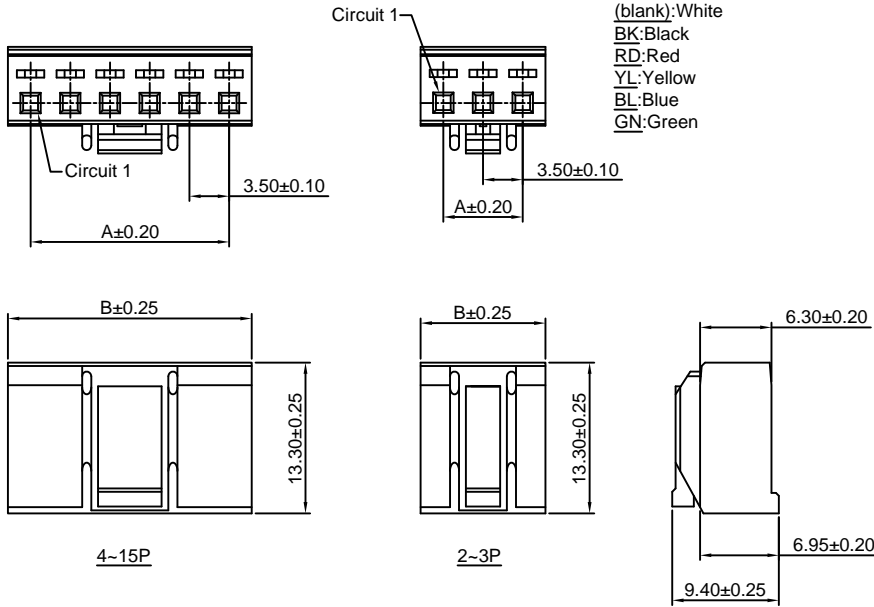
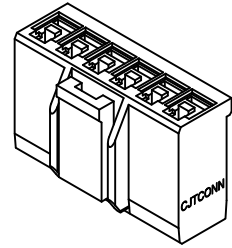

**Ordering Information & Dimensions:**

PART NO.	Dimensions	
	A	B
2P	3.50	7.50
3P	7.00	11.00
4P	10.50	14.50
5P	14.00	18.00
6P	17.50	21.50
7P	21.00	25.00
8P	24.50	28.50
9P	28.00	32.00
10P	31.50	35.50
11P	35.00	39.00
12P	38.50	42.50
13P	42.00	46.00
14P	45.50	49.50
15P	49.00	53.00

Unit: mm

### A3502WV-XP

3.50mm Pitch 180° WAFER

**Reference Informations:**

- \*Material:Pin:Brass/Tin over Nickel  
 Insulator:PBT+15%GF,UL94V-0
- \*Mates with CJT A3502H-XP series Housing
- \*Color:White

**Ordering Information:**

- A3502WV-XP - \*\*\* - \*\* - \*\*  
 1 2 3 4
- 1.Part No.
  - 2.Material:  
 (blank):PBT+15%GF,UL94V-0  
 GWT:PBT,UL94V-0,GWT 750°C
  - 3.Color:  
 (blank):White  
 BK:Black  
 RD:Red  
 YL:Yellow  
 BL:Blue  
 GN:Green  
 PK:Pink
  - 4.Finish:  
 (blank):Tin over Nickel  
 G:Gold over Nickel

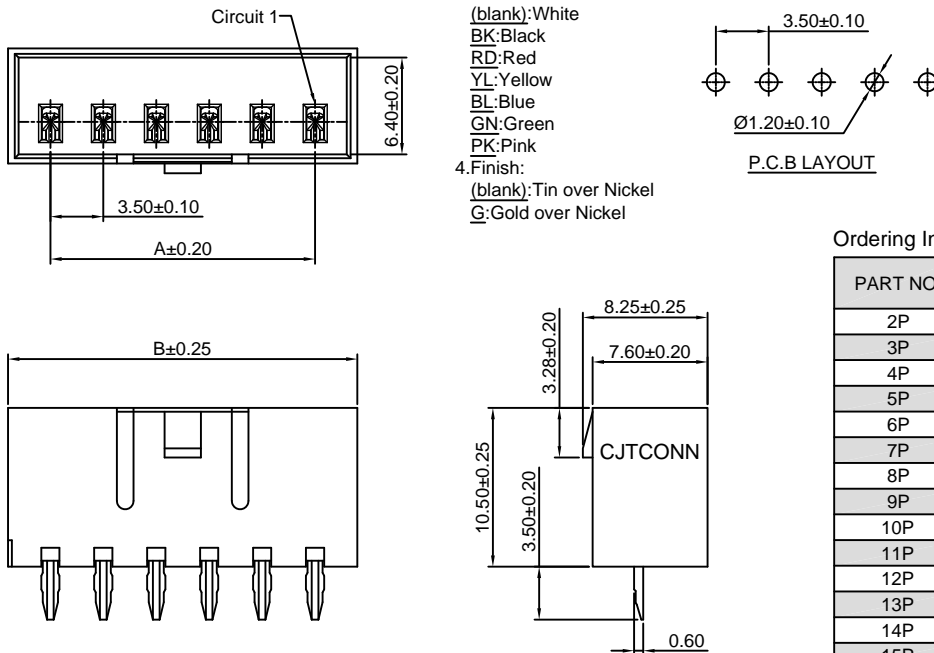
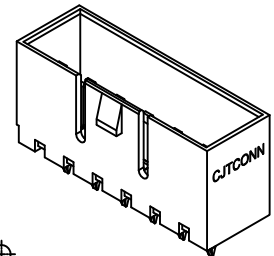

**Ordering Information & Dimensions:**

PART NO.	Dimensions	
	A	B
2P	3.50	9.10
3P	7.00	12.60
4P	10.50	16.10
5P	14.00	19.60
6P	17.50	23.10
7P	21.00	26.60
8P	24.50	30.10
9P	28.00	33.60
10P	31.50	37.10
11P	35.00	40.60
12P	38.50	44.10
13P	42.00	47.60
14P	45.50	51.10
15P	49.00	54.60

Unit: mm

## A3502WV-XP-A

7.00mm Pitch 180° WAFER

### Reference Informations:

- \*Material:Pin:Brass/Tin over Nickel  
Insulator:PBT+15%GF,UL94V-0
- \*Mates with CJT A3502H-XP series Housing
- \*Color:White

### Ordering Information:

A3502WV-XP-A - \*\*\* - \*\* - \*\*  
1 2 3 4

- 1.Part No.
- 2.Material:  
(blank):PBT+15%GF,UL94V-0  
GWT:PBT,UL94V-0,GWT 750°C
- 3.Color:  
(blank):White  
BK:Black  
RD:Red  
YL:Yellow  
BL:Blue  
GN:Green  
PK:Pink
- 4.Finish:  
(blank):Tin over Nickel  
G:Gold over Nickel

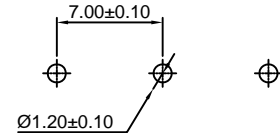
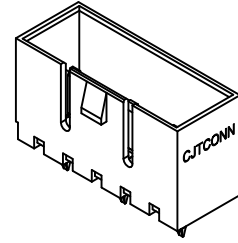
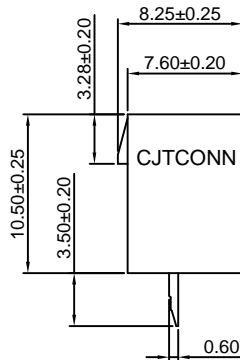
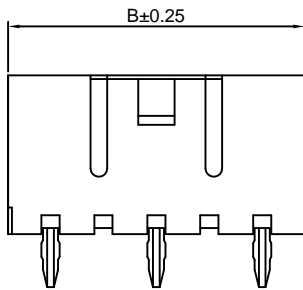
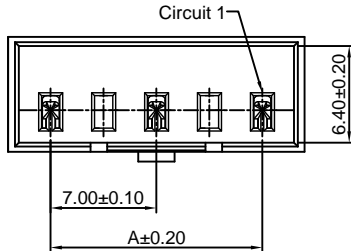

P.C.B LAYOUT

### Ordering Information & Dimensions:

PART NO.	Dimensions	
	A	B
3P	7.00	12.60
5P	14.00	19.60
7P	21.00	26.60
9P	28.00	33.60
11P	35.00	40.60
13P	42.00	47.60
15P	49.00	54.60

Unit: mm

## A3502WR-XP

3.50mm Pitch 90° WAFER

### Reference Informations:

- \*Material:Pin:Brass/Tin over Nickel  
Insulator:PBT+15%GF,UL94V-0
- \*Mates with CJT A3502H-XP series Housing
- \*Color:White

### Ordering Information:

A3502WR-XP - \*\*\* - \*\* - \*\*  
1 2 3 4

- 1.Part No.
- 2.Material:  
(blank):PBT+15%GF,UL94V-0  
GWT:PBT,UL94V-0,GWT 750°C
- 3.Color:  
(blank):White  
BK:Black  
RD:Red  
YL:Yellow  
BL:Blue  
GN:Green  
PK:Pink
- 4.Finish:  
(blank):Tin over Nickel  
G:Gold over Nickel

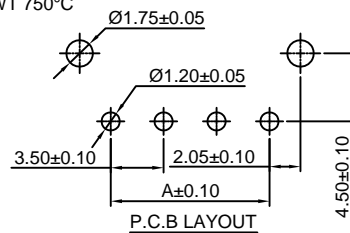
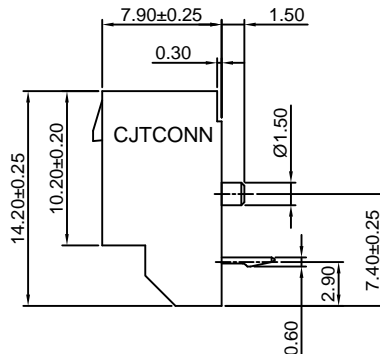
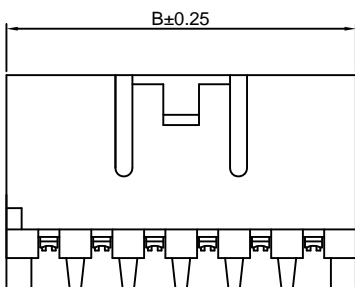
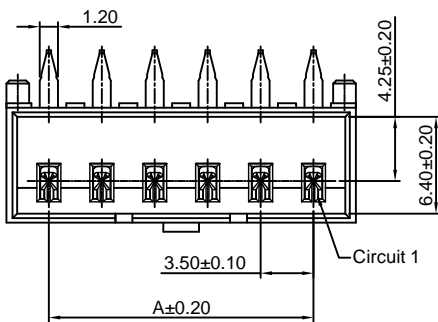

P.C.B LAYOUT

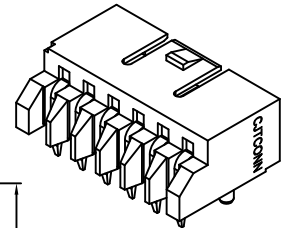

### Ordering Information & Dimensions:

PART NO.	Dimensions	
	A	B
2P	3.50	9.10
3P	7.00	12.60
4P	10.50	16.10
5P	14.00	19.60
6P	17.50	23.10
7P	21.00	26.60
8P	24.50	30.10
9P	28.00	33.60
10P	31.50	37.10
11P	35.00	40.60
12P	38.50	44.10
13P	42.00	47.60
14P	45.50	51.10
15P	49.00	54.60

Unit: mm

# A3502WR-XP-A

7.00mm Pitch 90° WAFER

#### Reference Informations:

- \*Material: Pin: Brass/Tin over Nickel  
Insulator: PBT+15%GF, UL94V-0
- \*Mates with CJT A3502H-XP series Housing
- \*Color: White

#### Ordering Information:

A3502WR-XP-A - \*\*\* - \*\* - \*\*  
1 2 3 4

1. Part No.
2. Material:  
(blank): PBT+15%GF, UL94V-0  
GWT: PBT, UL94V-0, GWT 750°C
3. Color:  
(blank): White  
BK: Black  
RD: Red  
YL: Yellow  
BL: Blue  
GN: Green  
PK: Pink
4. Finish:  
(blank): Tin over Nickel  
G: Gold over Nickel

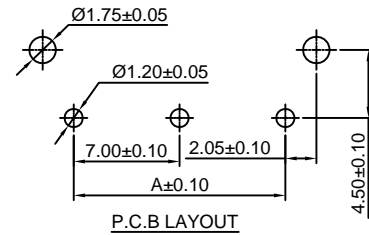
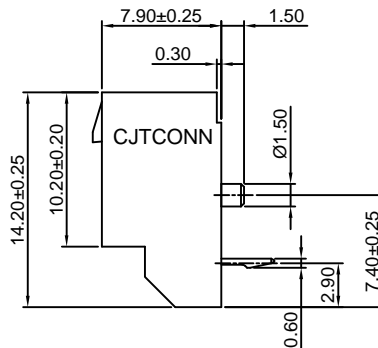
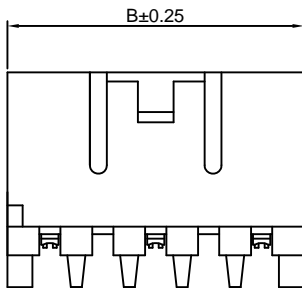
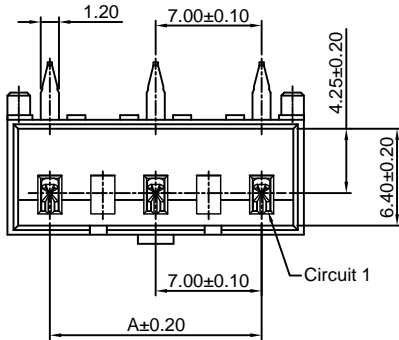
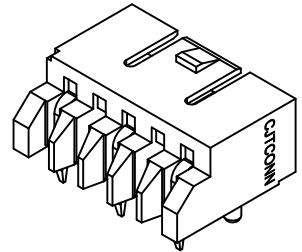

#### Ordering Information & Dimensions:

PART NO.	Dimensions	
	A	B
3P	7.00	12.60
5P	14.00	19.60
7P	21.00	26.60
9P	28.00	33.60
11P	35.00	40.60
13P	42.00	47.60
15P	49.00	54.60

Unit: mm

单击下面可查看定价，库存，交付和生命周期等信息

[>>CJT\(长江连接器\)](#)