

Specifications

- Current rating:3A AC,DC
- Voltage rating:250V AC,DC
- Temperature range:-40°C~+105°C
- Contact resistance:20mΩMax.
- Insulation resistance:1000MΩMin.
- Withstanding voltage:1500V AC/minute
- *Compliant with RoHS and REACH*
- *Meet the HF/Halogen Free,need to customize*
- *Contact CJT for details*

Standards



Assembly layout

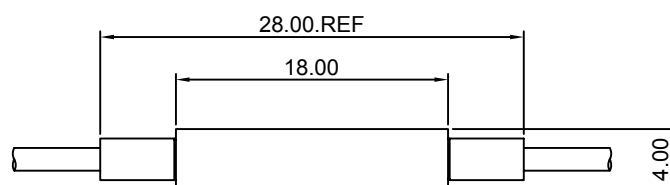
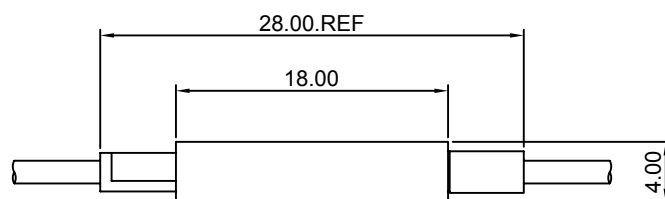

A2510HF-3P-P

2.54mm pitch Housing

Reference Informations:

- *Material:Nylon 66 ,UL94V-0
- *Suitable CJT A2541-T series Terminal
- *Mates with CJT A2510HM-P-R series Housing
- *Color:Black

Ordering Information:

A2510HF-3P-P - ***
 1 2

1.Part No.

2.Material:

(Blank):Nylon 66,UL94V-0

GWT :Nylon 66,UL94V-0,GWT 750 °C

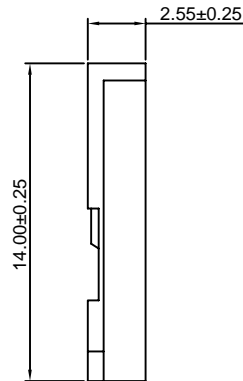
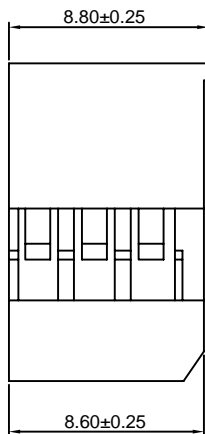
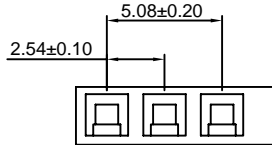
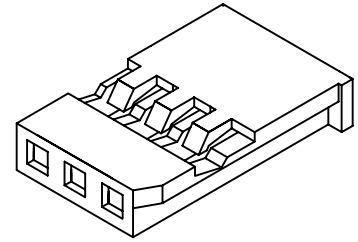

Unit: mm

A2510HF-3P-R

2.54mm pitch Housing

Reference Informations:

- *Material:Nylon 66 ,UL94V-0
- *Suitable CJT A2541-T series Terminal
- *Mates with CJT A2510HM-R-R series Housing
- *Color:Black

Ordering Information:

A2510HF-3P-R - ***
 1 2

1.Part No.

2.Material:

(Blank):Nylon 66,UL94V-0

GWT :Nylon 66,UL94V-0,GWT 750 °C

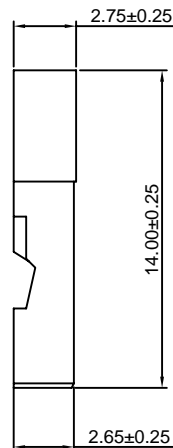
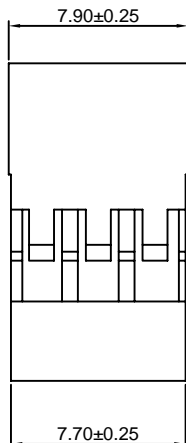
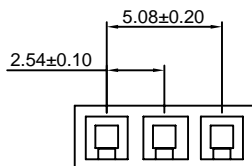
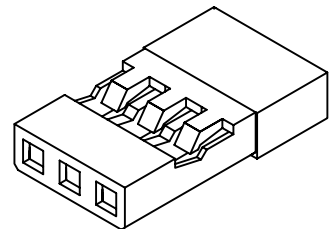

Unit: mm

A2510HM-P-R

2.54mm pitch Housing

Reference Informations:

- *Material:Nylon 66 ,UL94V-0
- *Mates with CJT A2510HF-3P-P series Housing
- *Color:Black

Ordering Information:

- A2510HM-P-R - ***
- 1 2
- 1.Part No.
- 2.Material:
- (Blank):Nylon 66,UL94V-0
- GWT :Nylon 66,UL94V-0,GWT 750 °C

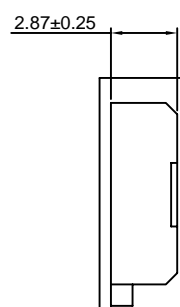
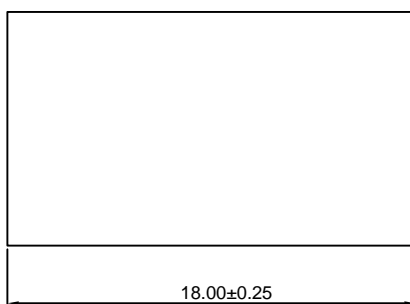
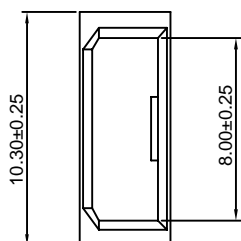
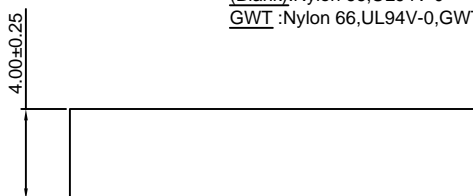
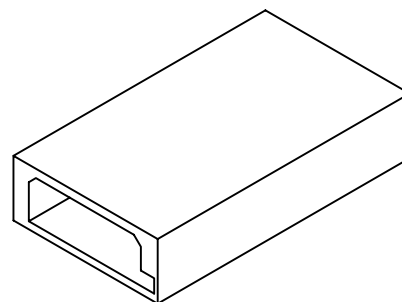

Unit: mm

A2510HM-R-R

2.54mm pitch Housing

Reference Informations:

- *Material:Nylon 66 ,UL94V-0
- *Mates with CJT A2510HF-3P-R series Housing
- *Color:Black

Ordering Information:

- A2510HM-R-R - ***
- 1 2
- 1.Part No.
- 2.Material:
- (Blank):Nylon 66,UL94V-0
- GWT :Nylon 66,UL94V-0,GWT 750 °C

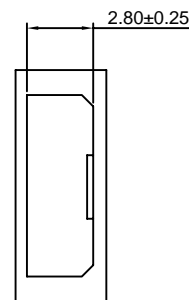
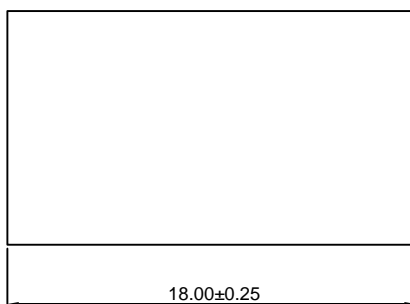
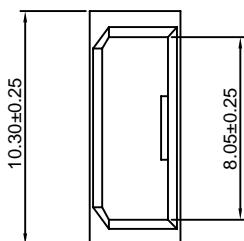
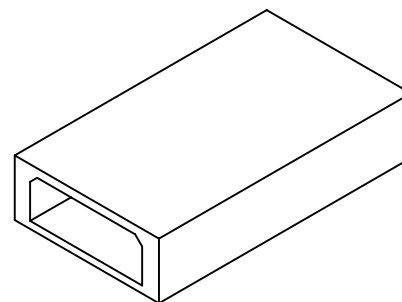

Unit: mm

A2510HMA-3P

2.54mm pitch Housing

Reference Informations:

- *Material:PBT ,UL94V-0
- *Suitable CJT A2541M-T Terminal
- *Mates with CJT A2510HF-3P-P series Housing
- *Color:Black

Ordering Information:

- A2510HMA-3P - *** - ***
 1 2 3
- 1.Part No.
 - 2.Material:
 (blank):PBT,UL94V-0
 GWT :PBT,UL94V-0,GWT 750℃
 - 3.Color:
 (blank):Black
 BRD:Brick red

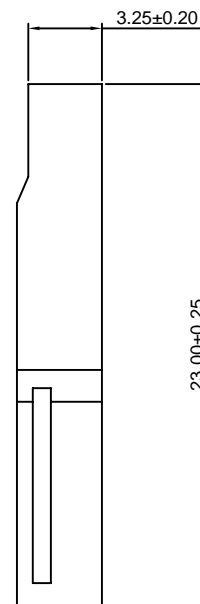
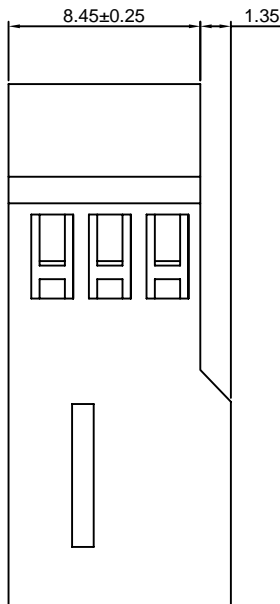
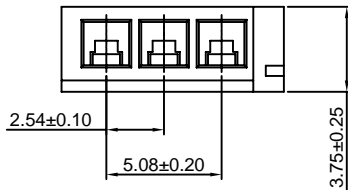
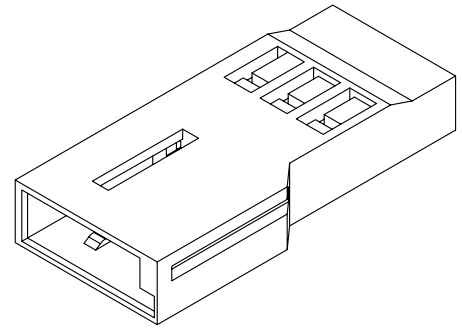

单击下面可查看定价，库存，交付和生命周期等信息

[>>CJT\(长江连接器\)](#)