

## Specifications

- Current rating: 3A AC, DC
- Voltage rating: 250V AC, DC
- Temperature range: -40°C ~ +105°C
- Contact resistance: 10mΩ Max.
- Insulation resistance: 1000MΩ Min.
- Withstanding voltage: 1000V AC/minute
- \*Compliant with RoHS and REACH\*
- \*Meet the HF/Halogen Free, need to customize\*
- \*Contact CJT for details\*

## Standards



## Assembly layout

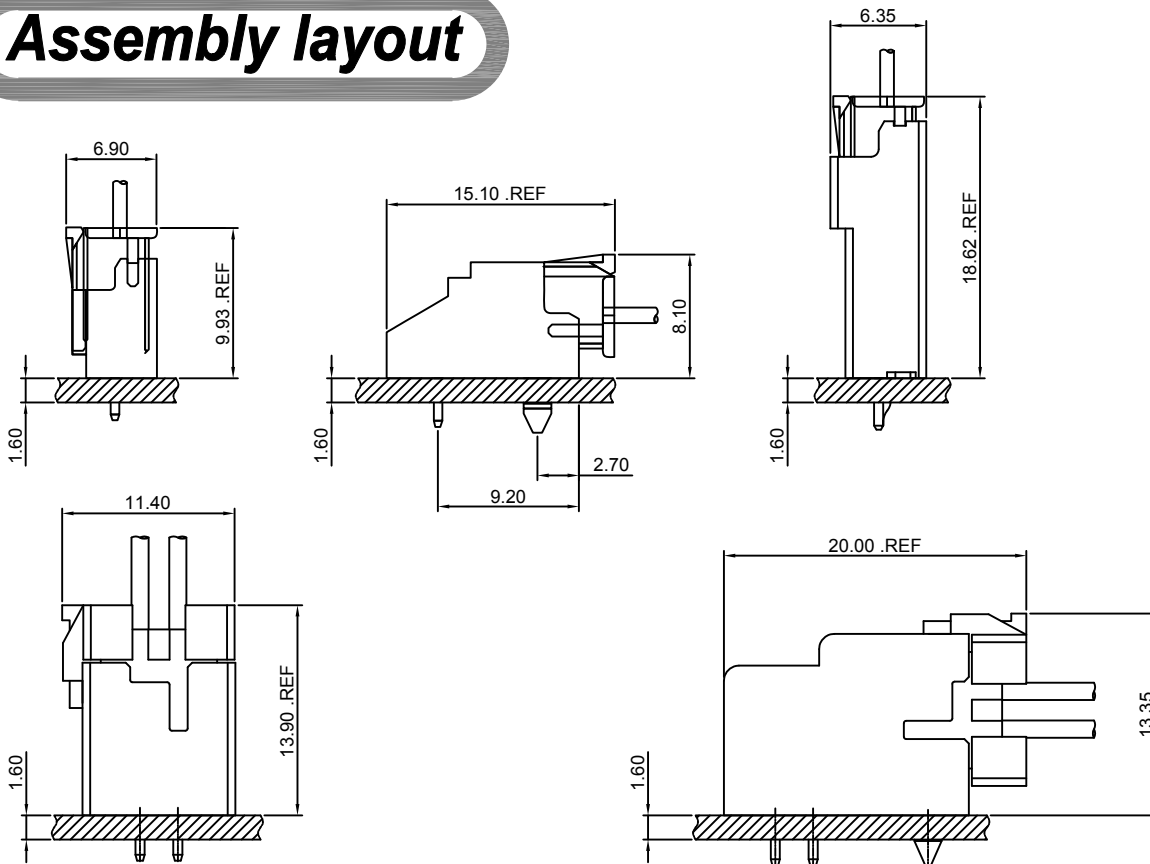

### A2508-T

2.50mm Pitch Crimp Terminal

**Reference Informations:**

\*Used in CJT A2508H,HA-XP ,A2508H-2xXP series Housing

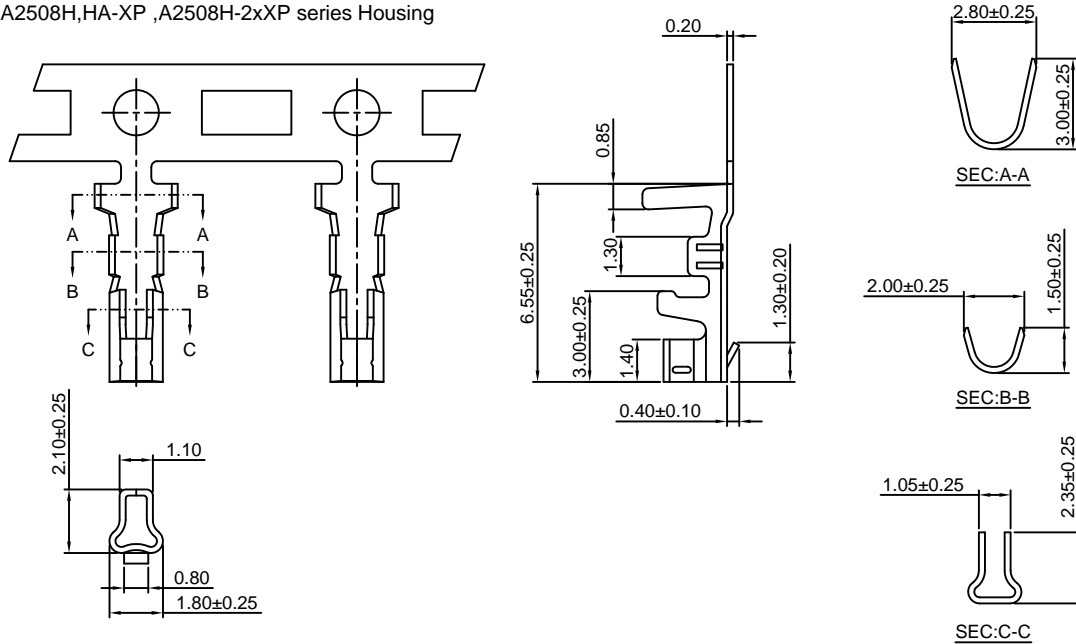

Ordering information & Specifications:

Unit:mm

Part NO	Wire Range	Insulation O.D.	Material	Finish	Qty/reel
A2508-TP	AWG#22-#26	1.90mm(max)	Phosphor Bronze	Tin over Nickel	10,000 PCS
A2508-GP	AWG#22-#26	1.90mm(max)	Phosphor Bronze	Gold over Nickel	10,000 PCS

Optional Gold plating available but MOQ requested

### A2508-T-L

2.50mm Pitch Crimp Terminal

**Reference Informations:**

\*Used in CJT A2508H,HA-XP ,A2508H-2xXP series Housing

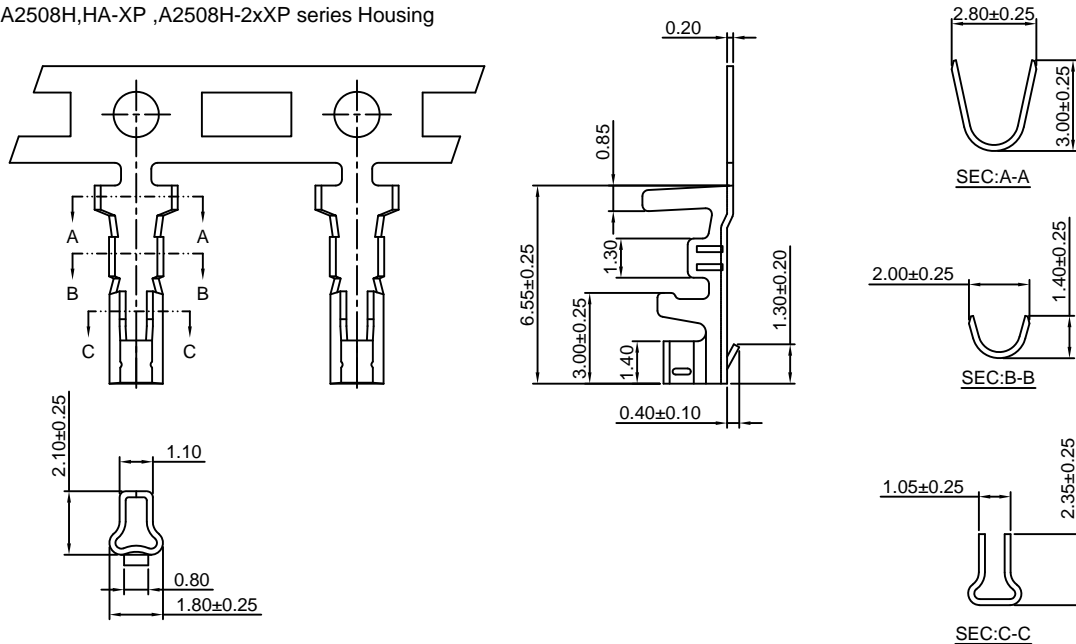

Ordering information & Specifications:

Unit:mm

Part NO	Wire Range	Insulation O.D.	Material	Finish	Qty/reel
A2508-TP-L	AWG#22-#28	1.90mm(max)	Phosphor Bronze	Tin over Nickel	10,000 PCS
A2508-GP-L	AWG#22-#28	1.90mm(max)	Phosphor Bronze	Gold over Nickel	10,000 PCS

Optional Gold plating available but MOQ requested

### A2508-T-H

2.50mm Pitch Crimp Terminal

**Reference Informations:**

\*Used in CJT A2508H,HA-XP ,A2508H-2xXP series Housing

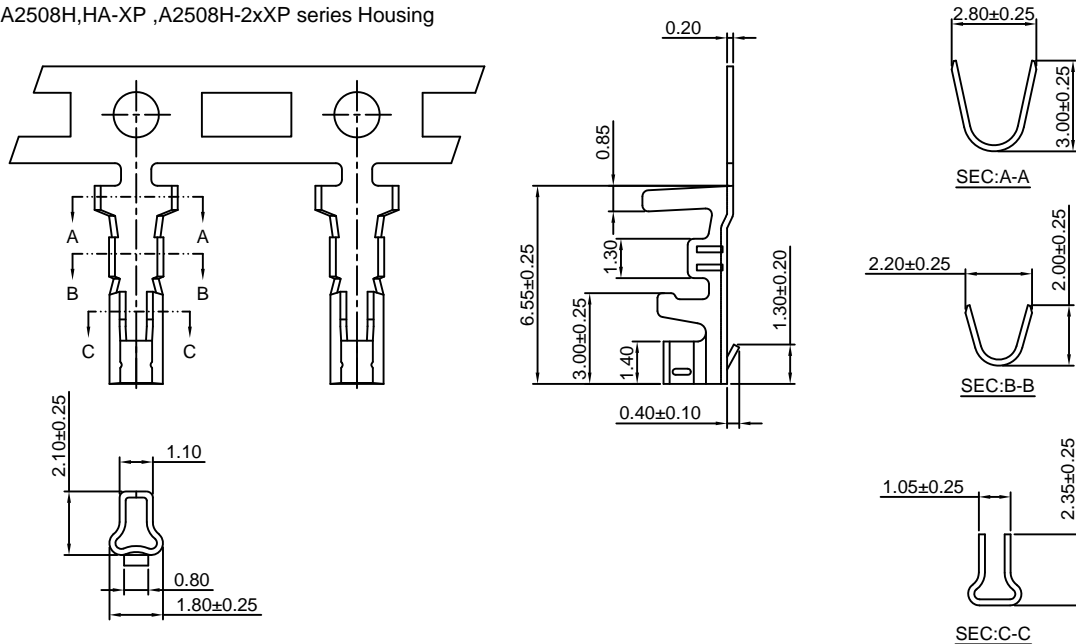

Ordering information & Specifications:

Unit:mm

Part NO	Wire Range	Insulation O.D.	Material	Finish	Qty/reel
A2508-TP-H	AWG#20-#24	1.90mm(max)	Phosphor Bronze	Tin over Nickel	10,000 PCS
A2508-GP-H	AWG#20-#24	1.90mm(max)	Phosphor Bronze	Gold over Nickel	10,000 PCS

Optional Gold plating available but MOQ requested

### A2508M-T

2.50mm Pitch Crimp Terminal

**Reference Informations:**

\*Used in CJT A2508HMA-XP series Housing

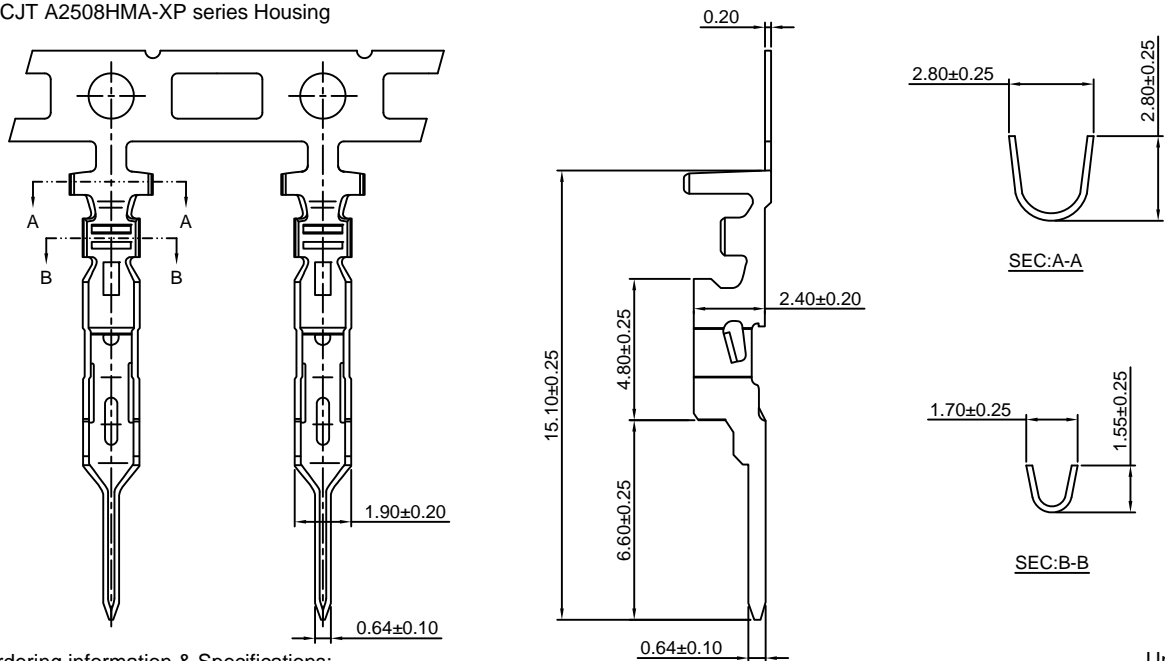

Ordering information & Specifications:

Unit:mm

Part NO	Wire Range	Insulation O.D.	Material	Finish	Qty/reel
A2508M-TP	AWG#22-#28	1.90mm(max)	Phosphor Bronze	Tin over Nickel	7,000 PCS
A2508M-GP	AWG#22-#28	1.90mm(max)	Phosphor Bronze	Gold over Nickel	7,000 PCS

Optional Gold plating available but MOQ requested

### A2508H-XP

2.50mm Pitch Housing

#### Reference Informations:

- \*Material:Nylon 66,UL94V-0
- \*Suitable CJT A2508-T series Terminal
- \*Mates with CJT A2508WV,WV-F-XP(-H), A2508WR,WR-F-XP,A2508WV-S-XP,A2508WVT-XP(-H), A2508WVT-F-XP(-H) series Wafer
- \*Color:White

#### Ordering Information:

- A2508H-XP - \*\*\* - \*\*  
 1                    2    3
- Part No.
  - Material:  
 (blank):Nylon 66,UL94V-0  
 GWT:Nylon 66,UL94V-0,GWT 750 °C
  - Color:  
 (Blank):White  
 RD:Red                    OR:Orange  
 YL:Yellow                GY:Gray  
 BL:Blue                    PK:Pink  
 BK:Black                  BR:Brown  
 GN:Green                VI:Violet  
 IV:Ivory                    LY:Lemon yellow  
 LE:Light blue            VY:Vivid yellow

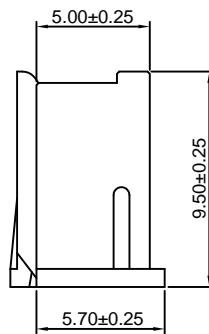
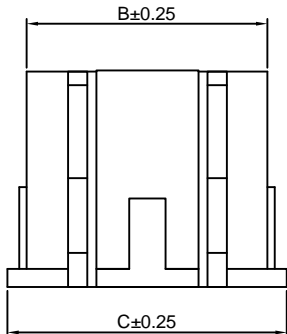
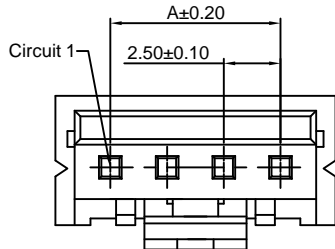
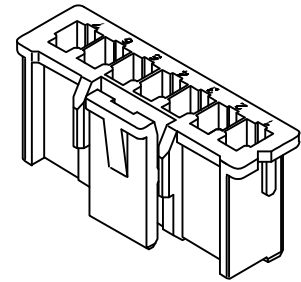

#### Ordering Information & Dimensions:

PART NO.	Dimensions		
	A	B	C
2P	2.50	5.64	7.30
3P	5.00	8.14	9.80
4P	7.50	10.64	12.30
5P	10.00	13.14	14.80
6P	12.50	15.64	17.30
7P	15.00	18.14	19.80
8P	17.50	20.64	22.30
9P	20.00	23.14	24.80
10P	22.50	25.64	27.30
11P	25.00	28.14	29.80
12P	27.50	30.64	32.30
13P	30.00	33.14	34.80
14P	32.50	35.64	37.30
15P	35.00	38.14	39.80

Unit: mm

### A2508HA-XP

2.50mm Pitch Housing

#### Reference Informations:

- \*Material:Nylon 66,UL94V-0
- \*Suitable CJT A2508-T series Terminal
- \*Mates with CJT A2508HMA-XP series Housing and A2508SA-XP series Seal and A2508WV,WV-F-XP(-H),A2508WR,WR-F-XP,A2508WV-S-XP, A2508WVT-XP(-H),A2508WVT-F-XP(-H) series Wafer
- \*Color:White

#### Ordering Information:

- A2508HA-XP - \*\*\* - \*\*  
 1                    2    3
- Part No.
  - Material:  
 (blank):Nylon 66,UL94V-0  
 GWT:Nylon 66,UL94V-0 , GWT 750 °C
  - Color:  
 (blank) : White  
 BK:Black  
 RD:Red  
 BL:Blue  
 LY:Lemon yellow

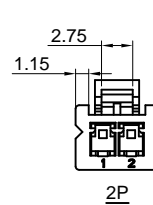
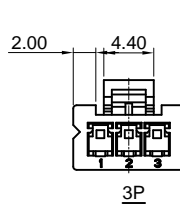
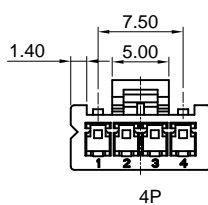
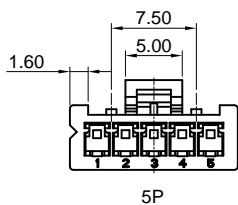
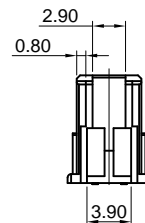
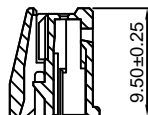
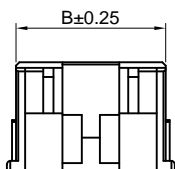
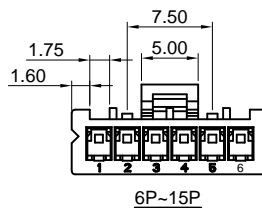
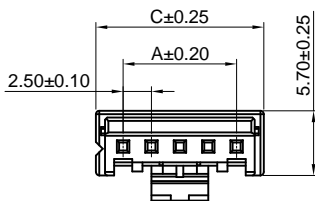

#### Ordering Information & Dimensions:

PART NO.	Dimensions		
	A	B	C
2P	2.50	5.70	7.30
3P	5.00	8.20	9.80
4P	7.50	10.70	12.30
5P	10.00	13.20	14.80
6P	12.50	15.70	17.30
7P	15.00	18.20	19.80
8P	17.50	20.70	22.30
9P	20.00	23.20	24.80
10P	22.50	25.70	27.30
11P	25.00	28.20	29.80
12P	27.50	30.70	32.30
13P	30.00	33.20	34.80
14P	32.50	35.70	37.30
15P	35.00	38.20	39.80

Unit: mm

### A2508HMA-XP

2.50mm Pitch Housing

**Reference Informations:**

- \*Material:Nylon 66,UL94V-0
- \*Suitable CJT A2508M-T series Terminal
- \*Mates with CJT A2508H,HA-XP series Housing
- \*Color:White

**Ordering Information:**

- A2508HMA-XP - \*\*\* - \*\*  
 $\frac{1}{2} \frac{3}{3}$
- Part No.
  - Material:  
 (blank):Nylon 66,UL94V-0  
 GWT:Nylon 66,UL94V-0 ,GWT 750°C
  - Color:  
 (Blank):White  
 RD:Red  
 YL:Yellow  
 BL:Blue  
 BK:Black  
 GN:Green  
 OR:Orange  
 GY:Gray  
 PK:Pink  
 BR:Brown  
 VI:Violet

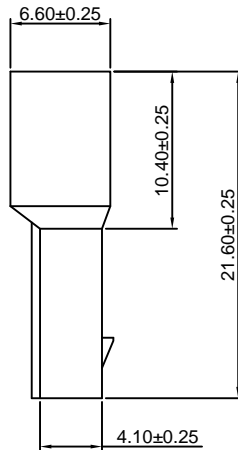
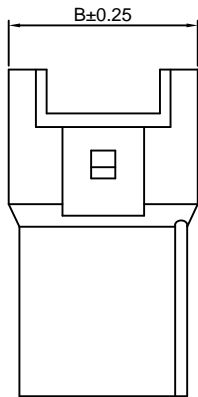
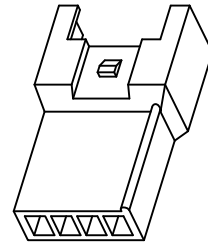
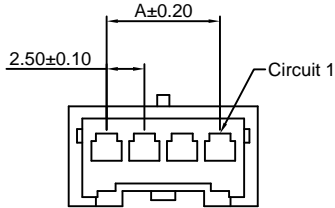

**Ordering Information & Dimensions:**

PART NO.	Dimensions	
	A	B
2P	2.50	7.50
3P	5.00	10.00
4P	7.50	12.50
5P	10.00	15.00
6P	12.50	17.50
7P	15.00	20.00
8P	17.50	22.50
9P	20.00	25.00
10P	22.50	27.50
11P	25.00	30.00
12P	27.50	32.50
13P	30.00	35.00
14P	32.50	37.50
15P	35.00	40.00

Unit: mm

### A2508SA-XP

2.50mm Pitch Seal

**Reference Informations:**

- \*Material:Nylon 66,UL94V-0
- \*Mates with CJT A2508HA-XP series Housing
- \*Color:Ivory

**Ordering Information:**

- A2508SA-XP - \*\*\*  
 $\frac{1}{2}$
- Part No.
  - Material:  
 (blank):Nylon 66,UL94V-0  
 GWT:Nylon 66,UL94V-0 ,GWT 750°C

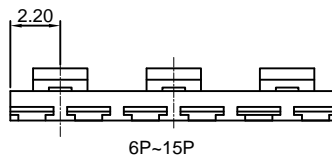
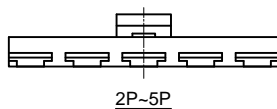
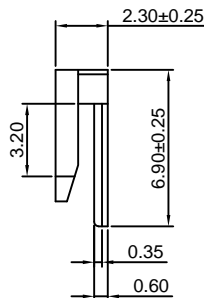
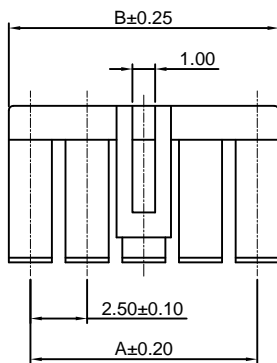

**Ordering Information & Dimensions:**

PART NO.	Dimensions	
	A	B
2P	2.50	4.40
3P	5.00	6.90
4P	7.50	9.40
5P	10.00	11.90
6P	12.50	14.40
7P	15.00	16.90
8P	17.50	19.40
9P	20.00	21.90
10P	22.50	24.40
11P	25.00	26.90
12P	27.50	29.40
13P	30.00	31.90
14P	32.50	34.40
15P	35.00	36.90

Unit: mm

### A2508WV-XP

2.50mm Pitch 180° Wafer

**Reference Informations:**

- \*Material: Pin: Brass/Tin over Nickel  
Insulator: Nylon 66, UL94V-0
- \*Mates with CJT A2508H, HA-XP series Housing
- \*Color: Ivory

**Ordering Information:**

- A2508WV-XP - \*\*\* - \*\* - \*\***
- 1      2      3      4
1. Part No.
  2. Material:  
(blank): Nylon 66, UL94V-0  
GWT: Nylon 66, UL94V-0, GWT 750°C
  3. Color:  
(Blank): Ivory  
RD: Red      OR: Orange  
YL: Yellow    GY: Gray  
BL: Blue      PK: Pink  
BK: Black     BR: Brown  
GN: Green    VI: Violet  
WH: White    LY: Lemon yellow  
LE: Light blue VY: Vivid yellow
  4. Finish:  
(blank): Tin over Nickel  
G: Gold over Nickel

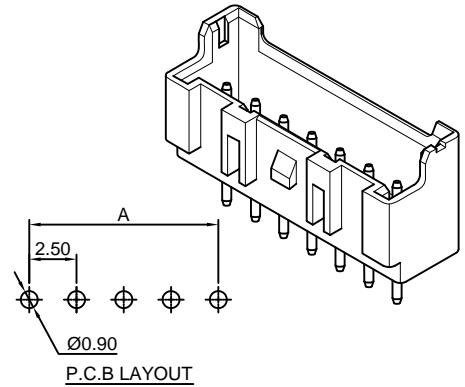
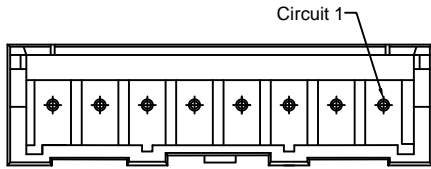

**Ordering Information & Dimensions:**

PART NO.	Dimensions	
	A	B
2P	2.50	7.50
3P	5.00	10.00
4P	7.50	12.50
5P	10.00	15.00
6P	12.50	17.50
7P	15.00	20.00
8P	17.50	22.50
9P	20.00	25.00
10P	22.50	27.50
11P	25.00	30.00
12P	27.50	32.50
13P	30.00	35.00
14P	32.50	37.50
15P	35.00	40.00

Unit: mm

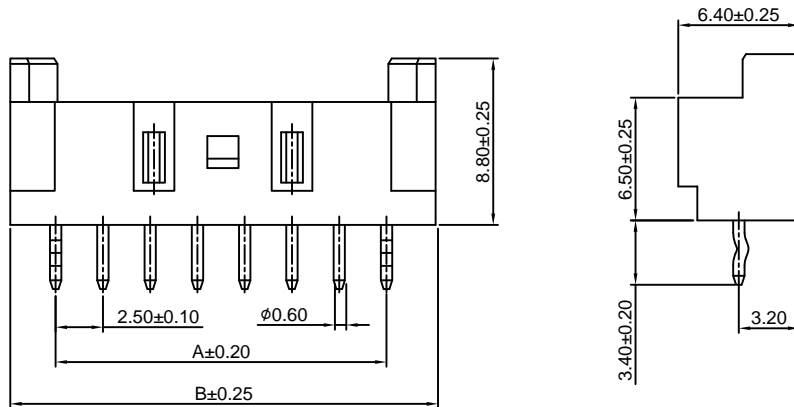

### A2508WR-XP

2.50mm Pitch 90° Wafer

**Reference Informations:**

- \*Material: Pin: Brass/Tin over Nickel  
Insulator: Nylon 66, UL94V-0
- \*Mates with CJT A2508H, HA-XP series Housing
- \*Color: Ivory

**Ordering Information:**

- A2508WR-XP - \*\*\* - \*\* - \*\***
- 1      2      3      4
1. Part No.
  2. Material:  
(blank): Nylon 66, UL94V-0  
GWT: Nylon 66, UL94V-0, GWT 750°C
  3. Color:  
(Blank): Ivory  
RD: Red      OR: Orange  
YL: Yellow    GY: Gray  
BL: Blue      PK: Pink  
BK: Black     BR: Brown  
GN: Green    VI: Violet  
WH: White    LY: Lemon yellow  
LE: Light blue VY: Vivid yellow
  4. Finish:  
(blank): Tin over Nickel  
G: Gold over Nickel

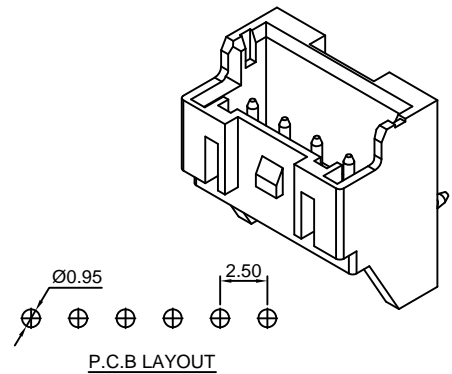
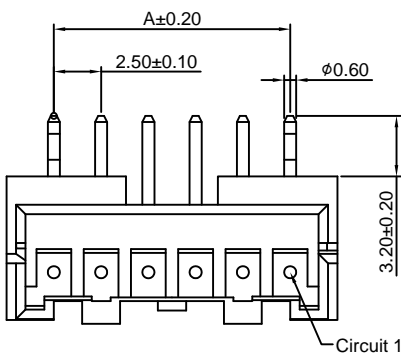

**Ordering Information & Dimensions:**

PART NO.	Dimensions	
	A	B
2P	2.50	7.50
3P	5.00	10.00
4P	7.50	12.50
5P	10.00	15.00
6P	12.50	17.50
7P	15.00	20.00
8P	17.50	22.50
9P	20.00	25.00
10P	22.50	27.50
11P	25.00	30.00
12P	27.50	32.50
13P	30.00	35.00
14P	32.50	37.50
15P	35.00	40.00

Unit: mm

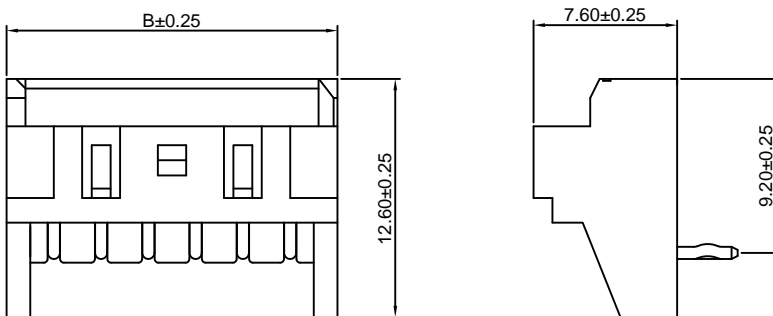

### A2508WV-F-XP

2.50mm Pitch 180° Wafer

#### Reference Informations:

- \*Material: Pin: Brass/Tin over Nickel  
Insulator: Nylon 66, UL94V-0
- \*Mates with CJT A2508H, HA-XP series Housing
- \*Color: Ivory

#### Ordering Information:

A2508WV-F-XP - \*\*\* - \*\* - \*\*  
1 2 3 4

- Part No.
- Material:  
(blank): Nylon 66, UL94V-0  
GWT: Nylon 66, UL94V-0, GWT 750 °C
- Color:  
(Blank): Ivory  
RD: Red  
YL: Yellow  
BL: Blue  
BK: Black  
GN: Green  
WH: White  
LE: Light blue  
OR: Orange  
GY: Gray  
PK: Pink  
BR: Brown  
VI: Violet  
LY: Lemon yellow  
VY: Vivid yellow
- Finish:  
(blank): Tin over Nickel  
G: Gold over Nickel

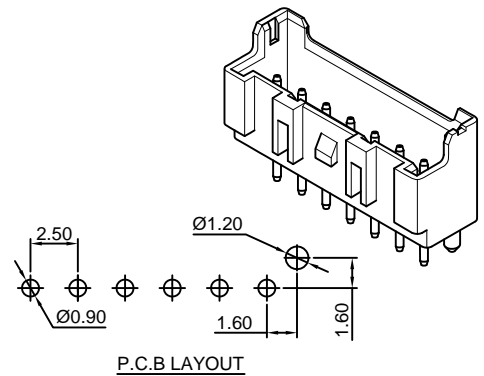
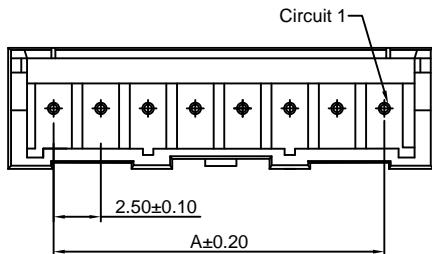

P.C.B LAYOUT

#### Ordering Information & Dimensions:

PART NO.	Dimensions	
	A	B
2P	2.50	7.50
3P	5.00	10.00
4P	7.50	12.50
5P	10.00	15.00
6P	12.50	17.50
7P	15.00	20.00
8P	17.50	22.50
9P	20.00	25.00
10P	22.50	27.50
11P	25.00	30.00
12P	27.50	32.50
13P	30.00	35.00
14P	32.50	37.50
15P	35.00	40.00

Unit: mm

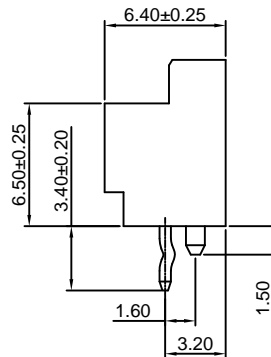
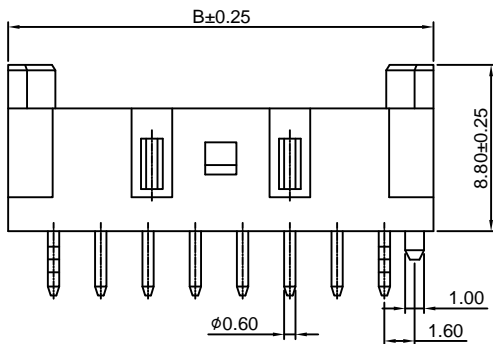

### A2508WR-F-XP

2.50mm Pitch 90° Wafer

#### Reference Informations:

- \*Material: Pin: Brass/Tin over Nickel  
Insulator: Nylon 66, UL94V-0
- \*Mates with CJT A2508H, HA-XP series Housing
- \*Color: Ivory

#### Ordering Information:

A2508WR-F-XP - \*\*\* - \*\* - \*\*  
1 2 3 4

- Part No.
- Material:  
(blank): Nylon 66, UL94V-0  
GWT: Nylon 66, UL94V-0, GWT 750 °C
- Color:  
(Blank): Ivory  
RD: Red  
YL: Yellow  
BL: Blue  
BK: Black  
GN: Green  
WH: White  
LE: Light blue  
OR: Orange  
GY: Gray  
PK: Pink  
BR: Brown  
VI: Violet  
LY: Lemon yellow  
VY: Vivid yellow
- Finish:  
(blank): Tin over Nickel  
G: Gold over Nickel

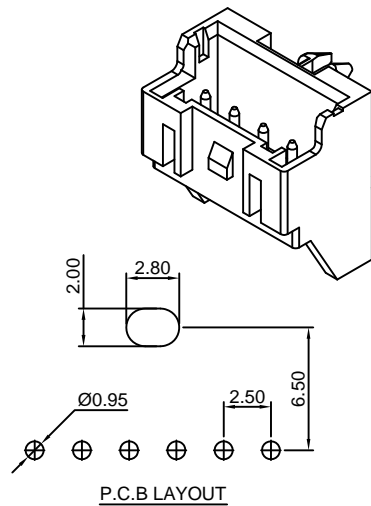
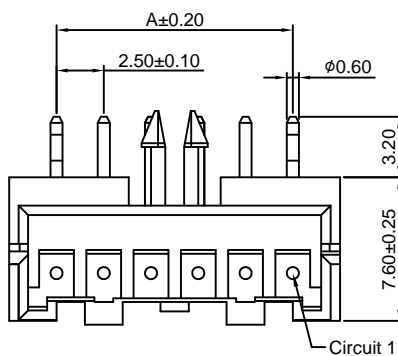

P.C.B LAYOUT

#### Ordering Information & Dimensions:

PART NO.	Dimensions	
	A	B
2P	2.50	7.50
3P	5.00	10.00
4P	7.50	12.50
5P	10.00	15.00
6P	12.50	17.50
7P	15.00	20.00
8P	17.50	22.50
9P	20.00	25.00
10P	22.50	27.50
11P	25.00	30.00
12P	27.50	32.50
13P	30.00	35.00
14P	32.50	37.50
15P	35.00	40.00

Unit: mm

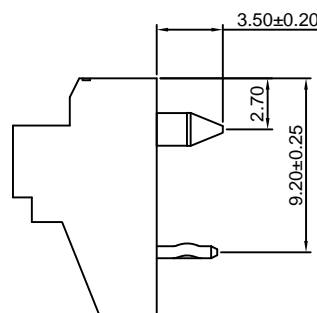
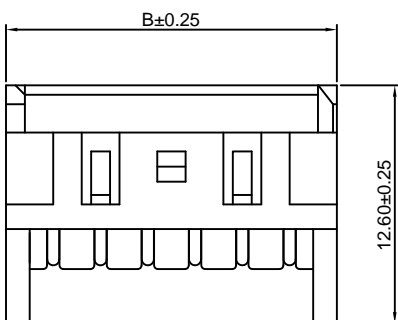



### A2508WV-XP-H

2.50mm Pitch 180° Wafer-High box type

**Reference Informations:**

- \*Material: Pin: Brass/Tin over Nickel  
Insulator: Nylon 66, UL94V-0
- \*Mates with CJT A2508H, HA-XP series Housing
- \*Color: Ivory

- Ordering Information:  
A2508WV-XP-H - \*\*\* - \*\* - \*\*  
1 2 3 4
- Part No.
  - Material:  
(blank): Nylon 66, UL94V-0  
GWT: Nylon 66, UL94V-0, GWT 750 °C
  - Color:  
(blank): Ivory  
BK: Black  
RD: Red  
YL: Yellow  
GN: Green
  - Finish:  
(blank): Tin over Nickel  
G: Gold over Nickel

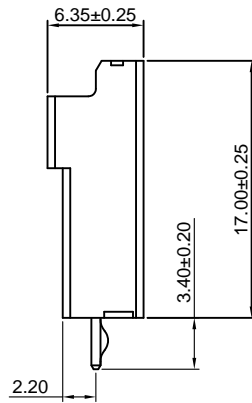
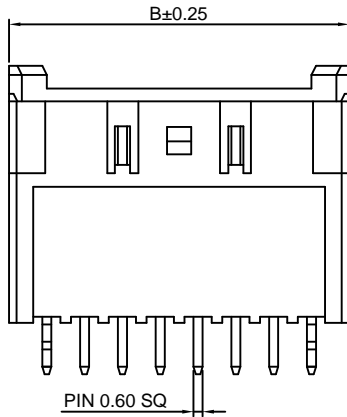
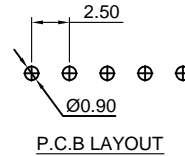
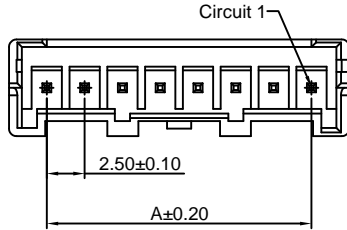
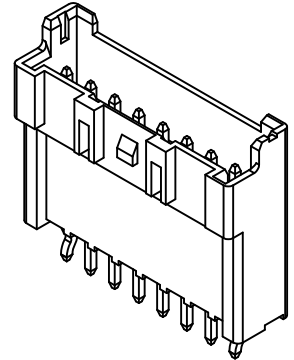

Ordering Information & Dimensions:

PART NO.	Dimensions	
	A	B
2P	2.50	7.50
3P	5.00	10.00
4P	7.50	12.50
5P	10.00	15.00
6P	12.50	17.50
7P	15.00	20.00
8P	17.50	22.50
9P	20.00	25.00
10P	22.50	27.50
11P	25.00	30.00
12P	27.50	32.50
13P	30.00	35.00
14P	32.50	37.50
15P	35.00	40.00

Unit: mm

### A2508WV-F-XP-H

2.50mm Pitch 180° Wafer-High box type

**Reference Informations:**

- \*Material: Pin: Brass/Tin over Nickel  
Insulator: Nylon 66, UL94V-0
- \*Mates with CJT A2508H, HA-XP series Housing
- \*Color: Ivory

- Ordering Information:  
A2508WV-F-XP-H - \*\*\* - \*\* - \*\*  
1 2 3 4
- Part No.
  - Material:  
(blank): Nylon 66, UL94V-0  
GWT: Nylon 66, UL94V-0, GWT 750 °C
  - Color:  
(blank): Ivory  
BK: Black  
RD: Red  
YL: Yellow  
GN: Green
  - Finish:  
(blank): Tin over Nickel  
G: Gold over Nickel

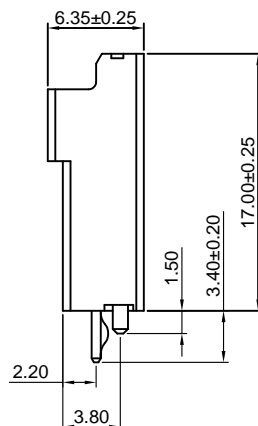
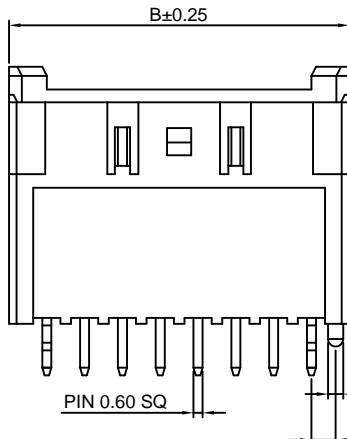
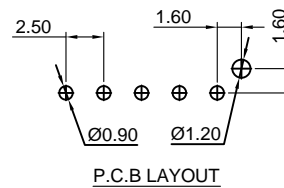
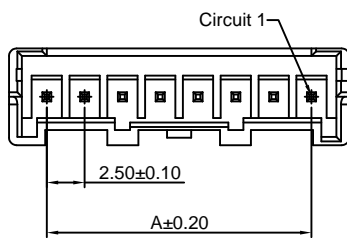
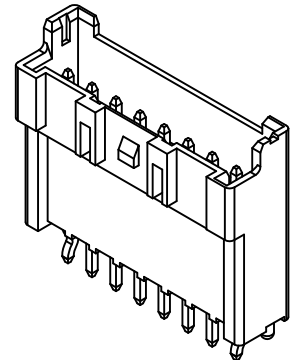

Ordering Information & Dimensions:

PART NO.	Dimensions	
	A	B
2P	2.50	7.50
3P	5.00	10.00
4P	7.50	12.50
5P	10.00	15.00
6P	12.50	17.50
7P	15.00	20.00
8P	17.50	22.50
9P	20.00	25.00
10P	22.50	27.50
11P	25.00	30.00
12P	27.50	32.50
13P	30.00	35.00
14P	32.50	37.50
15P	35.00	40.00

Unit: mm



### A2508WV-S-XP

2.50mm Pitch 180° Wafer - SMT TYPE

#### Reference Informations:

- \*Material: Pin: Brass/Tin over Nickel  
Insulator: Nylon 9T, UL94V-0
- \*Mates with CJT A2508H, HA-XP series Housing
- \*Color: Ivory

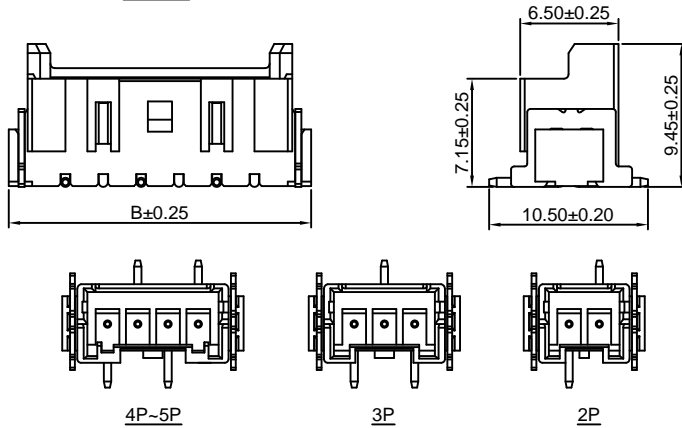
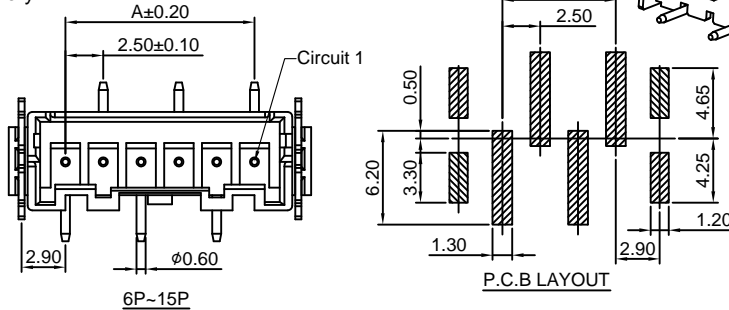

#### Ordering Information:

A2508WV-S-XP - \*\*\* - \*\* - \*\*  
1 2 3 4

- Part No.
- Material:  
(blank): Nylon 66, UL94V-0  
GWT: Nylon 66, UL94V-0, GWT 750°C
- Color:  
(Blank): Ivory  
RD: Red OR: Orange  
BL: Blue BK: Black  
GN: Green LY: Lemon yellow
- Finish:  
(blank): Tin over Nickel  
G: Gold over Nickel

#### Ordering Information & Dimensions:

PART NO.	Dimensions	
	A	B
2P	2.50	10.00
3P	5.00	12.50
4P	7.50	15.00
5P	10.00	17.50
6P	12.50	20.00
7P	15.00	22.50
8P	17.50	25.00
9P	20.00	27.50
10P	22.50	30.00
11P	25.00	32.50
12P	27.50	35.00
13P	30.00	37.50
14P	32.50	40.00
15P	35.00	42.50

Unit: mm

### A2508H-2xXP

2.50mm Pitch Dual Row Housing

#### Reference Informations:

- \*Material: Nylon 66, UL94V-0
- \*Suitable CJT A2508-T series Terminal
- \*Mates with CJT A2508WV, WV-F-2xXP series Wafer
- \*Color: White

#### Ordering Information:

A2508H-2xXP - \*\*\* - \*\*  
1 2 3

- Part No.
- Material:  
(blank): Nylon 66, UL94V-0  
GWT: Nylon 66, UL94V-0, GWT 750°C
- Color:  
(Blank): White  
BK: Black  
RD: Red  
BL: Blue  
GN: Green  
PK: Pink  
LY: Lemon yellow

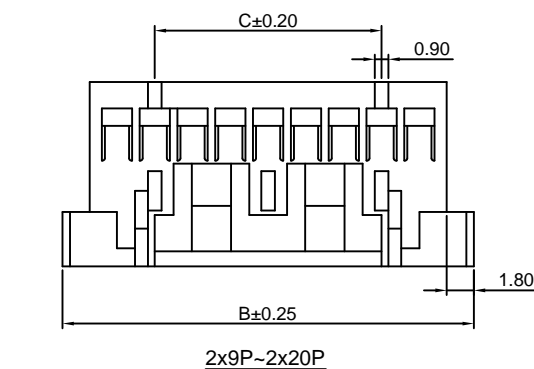
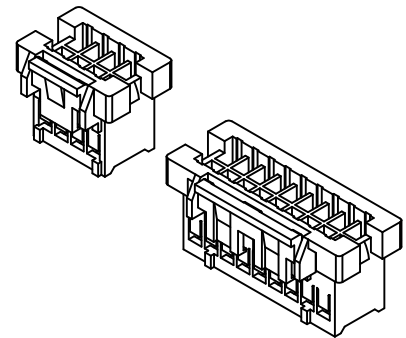
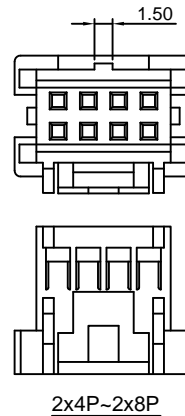
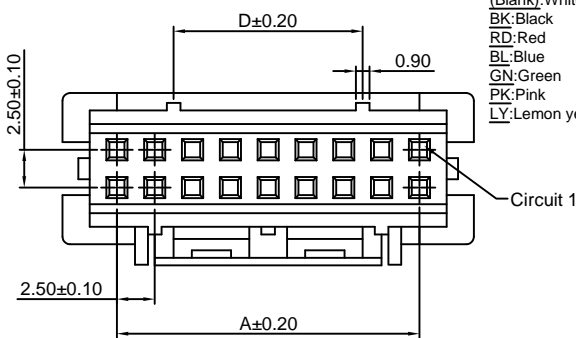

#### Ordering Information & Dimensions:

PART NO.	Dimensions			
	A	B	C	D
2x4P	7.50	14.70	9.10	----
2x5P	10.00	17.20	7.50	----
2x6P	12.50	19.70	10.00	----
2x7P	15.00	22.20	12.50	----
2x8P	17.50	24.70	15.00	----
2x9P	20.00	27.20	15.00	12.50
2x10P	22.50	29.70	17.50	15.00
2x11P	25.00	32.20	20.00	17.50
2x12P	27.50	34.70	22.50	20.00
2x13P	30.00	37.20	25.00	22.50
2x14P	32.50	39.70	27.50	25.00
2x15P	35.00	42.20	30.00	27.50
2x16P	37.50	44.70	32.50	30.00
2x17P	40.00	47.20	35.00	32.50
2x18P	42.50	49.70	37.50	35.00
2x19P	45.00	52.20	40.00	37.50
2x20P	47.50	54.70	42.50	40.00

Unit: mm

### A2508WV(-F)-2xXP

2.50mm Pitch Dual Row 180° Wafer

#### Reference Informations:

- \*Material: Pin: Brass/Tin over Nickel  
Insulator: Nylon 66, UL94V-0
- \*Mates with CJT A2508H-2xXP series Housing
- \*Color: Ivory

Ordering Information:  
A2508WV(-F)-2xXP - \*\*\* - \*\*  
1 2 3

1. Part No.
2. Material:  
(blank): Nylon 66, UL94V-0  
GWT: Nylon 66, UL94V-0, GWT 750 °C
3. Color:  
(Blank): White  
BK: Black  
RD: Red  
BL: Blue  
GN: Green  
PK: Pink  
LY: Lemon yellow

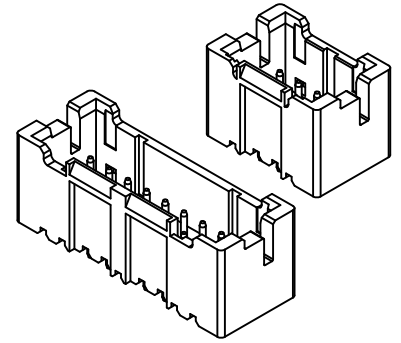
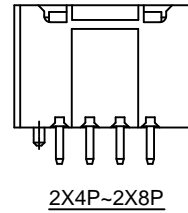
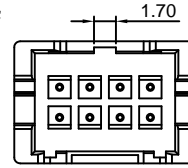
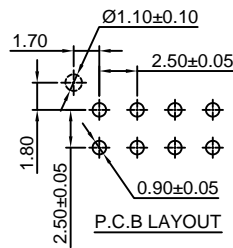
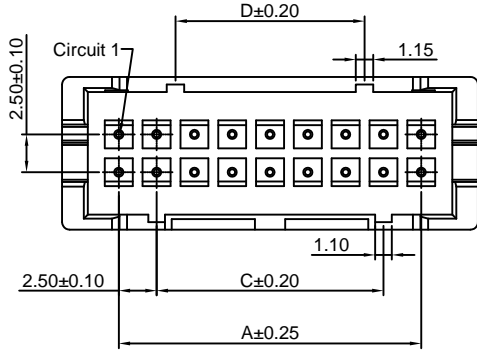

#### Ordering Information & Dimensions:

PART NO.	Dimensions			
	A	B	C	D
2x4P	7.50	14.70	9.10	----
2x5P	10.00	17.20	7.50	----
2x6P	12.50	19.70	10.00	----
2x7P	15.00	22.20	12.50	----
2x8P	17.50	24.70	15.00	----
2x9P	20.00	27.20	15.00	12.50
2x10P	22.50	29.70	17.50	15.00
2x11P	25.00	32.20	20.00	17.50
2x12P	27.50	34.70	22.50	20.00
2x13P	30.00	37.20	25.00	22.50
2x14P	32.50	39.70	27.50	25.00
2x15P	35.00	42.20	30.00	27.50
2x16P	37.50	44.70	32.50	30.00
2x17P	40.00	47.20	35.00	32.50
2x18P	42.50	49.70	37.50	35.00
2x19P	45.00	52.20	40.00	37.50
2x20P	47.50	54.70	42.50	40.00

Unit: mm

2X9P~2X21P

### A2508WR-F-2xXP

2.50mm Pitch Dual Row 90° Wafer

#### Reference Informations:

- \*Material: Pin: Brass/Tin over Nickel  
Insulator: Nylon 66, UL94V-0
- \*Mates with CJT A2508H-2xXP series Housing
- \*Color: Ivory

Ordering Information:  
A2508WR-F-2xXP - \*\*\* - \*\*  
1 2 3

1. Part No.
2. Material:  
(blank): Nylon 66, UL94V-0  
GWT: Nylon 66, UL94V-0, GWT 750 °C
3. Color:  
(Blank): White  
BK: Black  
RD: Red  
BL: Blue  
GN: Green  
PK: Pink  
LY: Lemon yellow

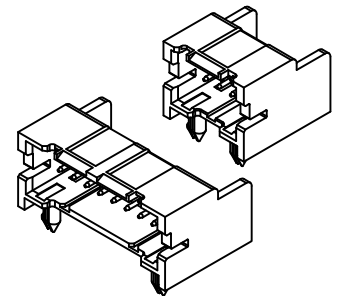
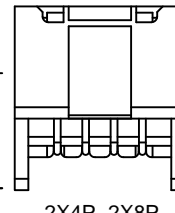
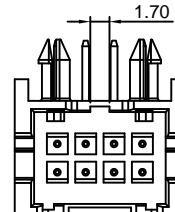
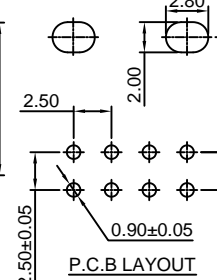
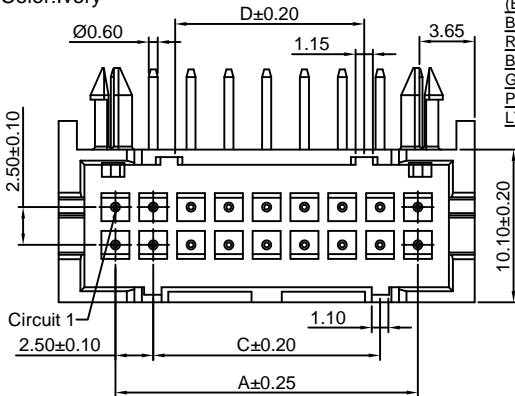

#### Ordering Information & Dimensions:

PART NO.	Dimensions			
	A	B	C	D
2x4P	7.50	14.70	9.10	----
2x5P	10.00	17.20	7.50	----
2x6P	12.50	19.70	10.00	----
2x7P	15.00	22.20	12.50	----
2x8P	17.50	24.70	15.00	----
2x9P	20.00	27.20	15.00	12.50
2x10P	22.50	29.70	17.50	15.00
2x11P	25.00	32.20	20.00	17.50
2x12P	27.50	34.70	22.50	20.00
2x13P	30.00	37.20	25.00	22.50
2x14P	32.50	39.70	27.50	25.00
2x15P	35.00	42.20	30.00	27.50
2x16P	37.50	44.70	32.50	30.00
2x17P	40.00	47.20	35.00	32.50
2x18P	42.50	49.70	37.50	35.00
2x19P	45.00	52.20	40.00	37.50
2x20P	47.50	54.70	42.50	40.00

Unit: mm

2X9P~2X21P

### A2508WVT(-F)-XP

2.50mm pitch 180° Wafer ON RADIAL-TAPE

#### Reference Informations:

- \*Material: Pin: Brass/Tin over Nickel  
Insulator: Nylon 66, UL94V-0
- \*Mates with CJT A2508H, HA-XP series Housing
- \*Color: Ivory

#### Ordering Information:

- A2508WVT(-F)-XP - \*\*\* - \*\* - \*\*
1. Part No.
  2. Material:  
(blank): Nylon 66, UL94V-0  
GWT: Nylon 66, UL94V-0, GWT 750 °C
  3. Color:  
(blank) : Ivory  
BK : Black  
RD : Red  
BL : Blue  
YL : Yellow  
GN : Green
  4. Finish:  
(blank): Tin over Nickel  
G: Gold over Nickel

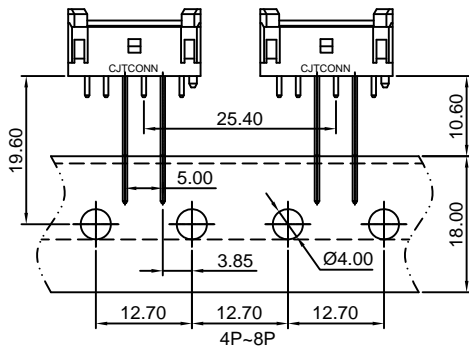
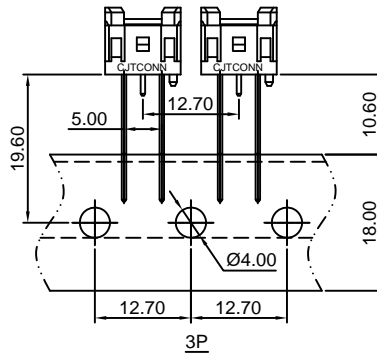
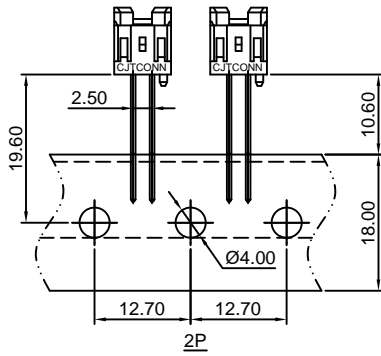
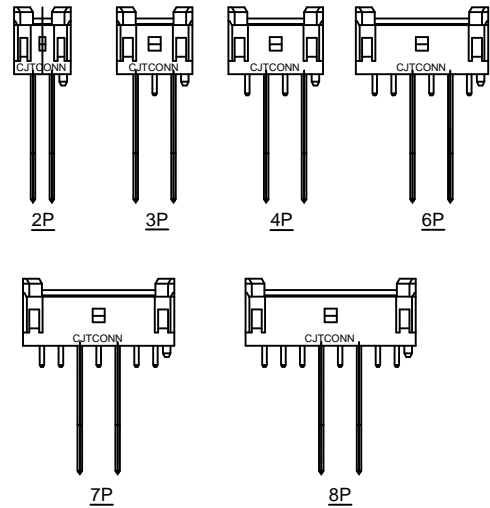
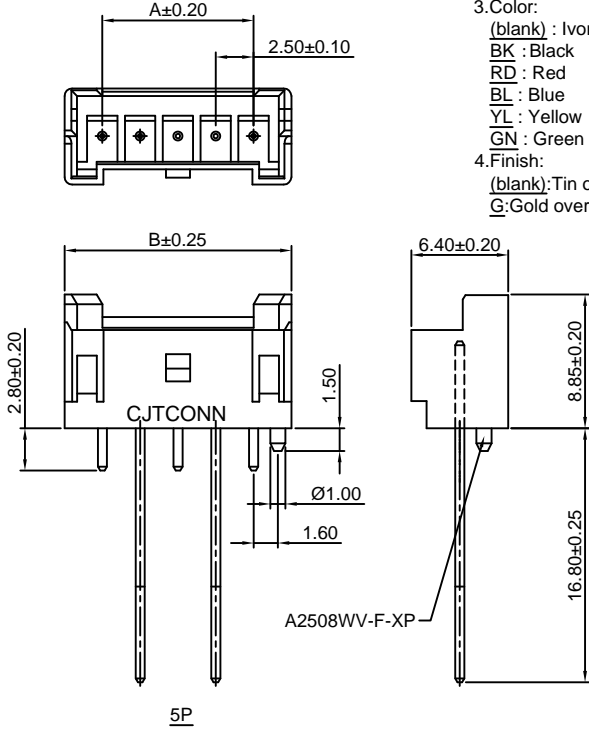
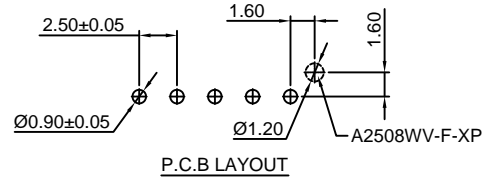

#### Ordering Information & Dimensions:

PART NO.	Dimensions	
	A	B
2P	2.50	7.50
3P	5.00	10.00
4P	7.50	12.50
5P	10.00	15.00
6P	12.50	17.50
7P	15.00	20.00
8P	17.50	22.50

Unit: mm

### A2508WVT(-F)-XP-H

2.50mm pitch 180° Wafer ON RADIAL-TAPE

#### Reference Informations:

- \*Material: Pin: Brass/Tin over Nickel  
Insulator: Nylon 66, UL94V-0
- \*Mates with CJT A2508H, HA-XP series Housing
- \*Color: Ivory

#### Ordering Information:

A2508WVT(-F)-XP-H - \*\*\* - \*\* - \*\*

1. Part No.
2. Material:  
(blank): Nylon 66, UL94V-0  
GWT: Nylon 66, UL94V-0, GWT 750 °C
3. Color:  
(blank): Ivory  
BK: Black  
RD: Red  
BL: Blue  
YL: Yellow  
GN: Green
4. Finish:  
(blank): Tin over Nickel  
G: Gold over Nickel

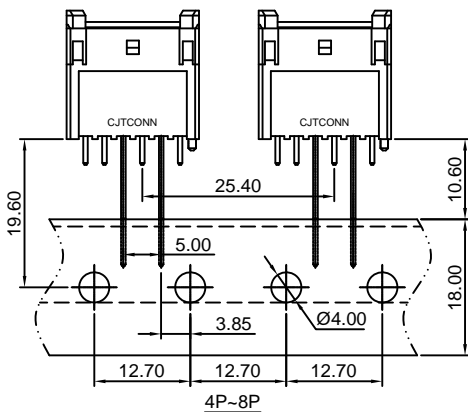
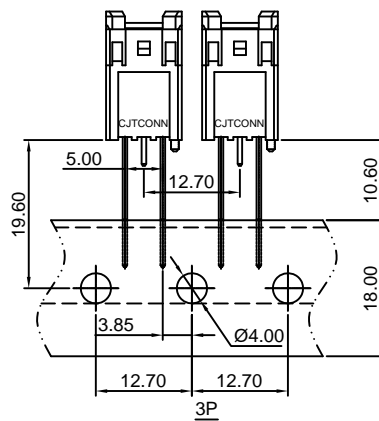
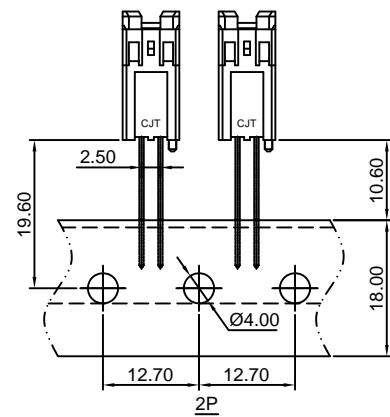
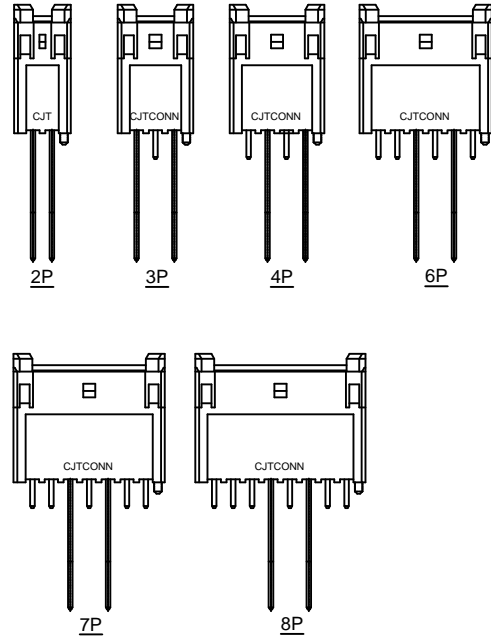
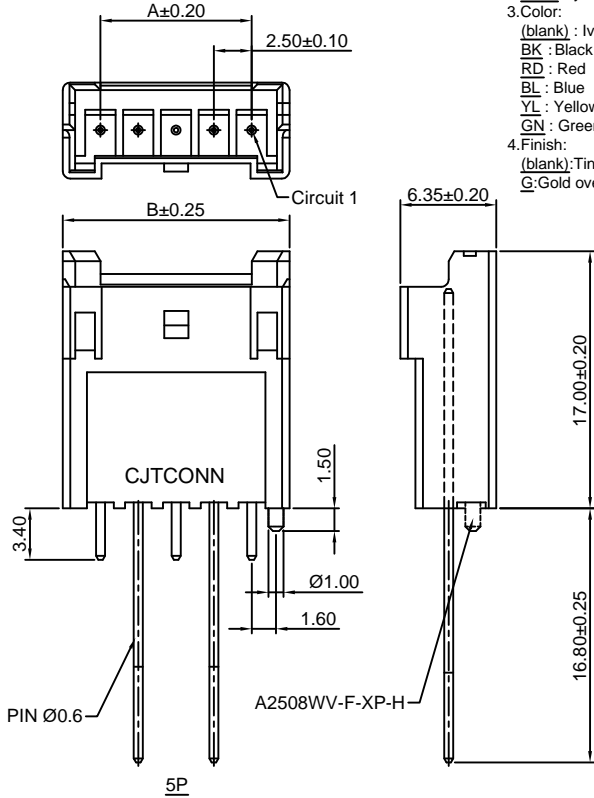
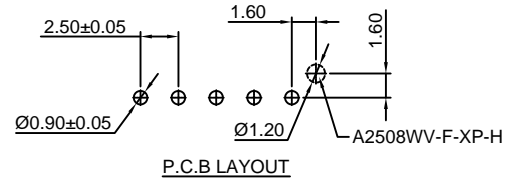

#### Ordering Information & Dimensions:

PART NO.	Dimensions	
	A	B
2P	2.50	7.50
3P	5.00	10.00
4P	7.50	12.50
5P	10.00	15.00
6P	12.50	17.50
7P	15.00	20.00
8P	17.50	22.50

Unit: mm

单击下面可查看定价，库存，交付和生命周期等信息

[>>CJT\(长江连接器\)](#)