

Specifications

- Current rating: 3A AC, DC
- Voltage rating: 250V AC, DC
- Temperature range: -40°C ~ +105°C
- Contact resistance: 10mΩ Max.
- Insulation resistance: 1000MΩ Min.
- Withstanding voltage: 1000V AC/minute
- *Compliant with RoHS and REACH*
- *Meet the HF/Halogen Free, need to customize*
- *Contact CJT for details*

Standards

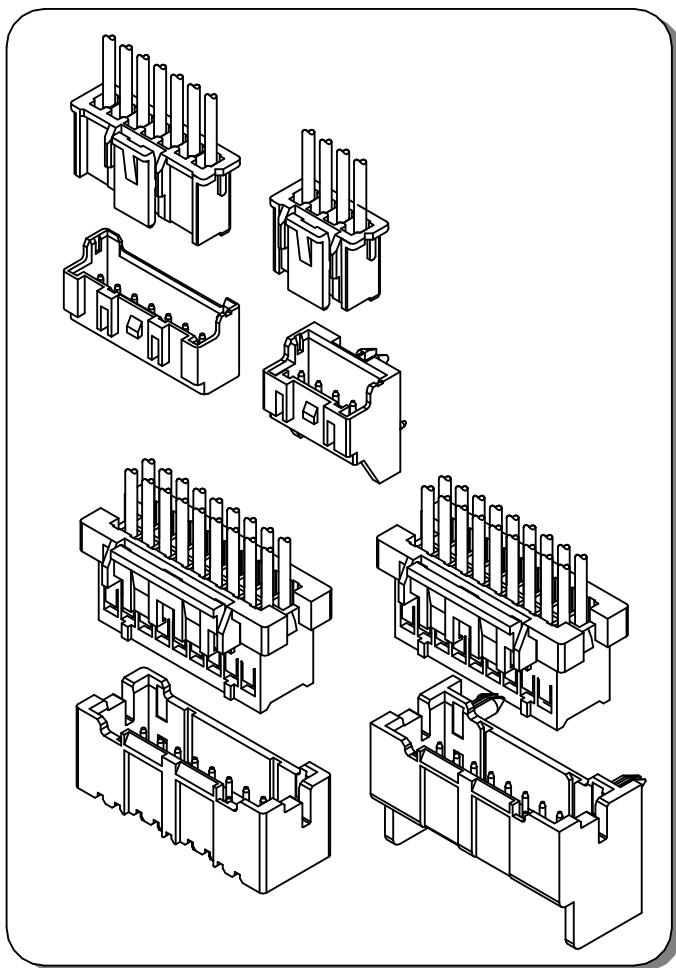

Assembly layout

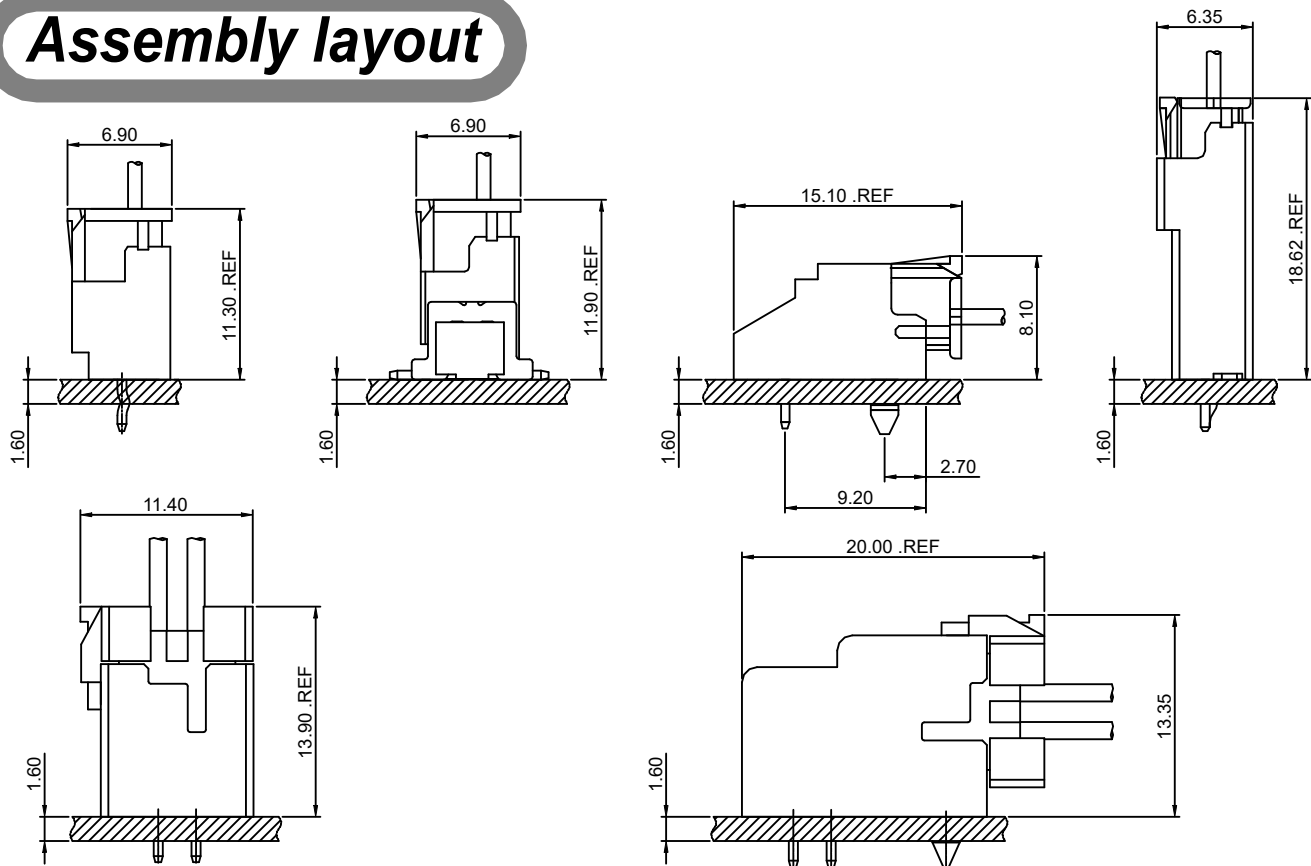

A2508-T

2.50mm Pitch Crimp Terminal

Reference Informations:

*Used in CJT A2508H,HA-XP ,A2508H-2xXP series Housing

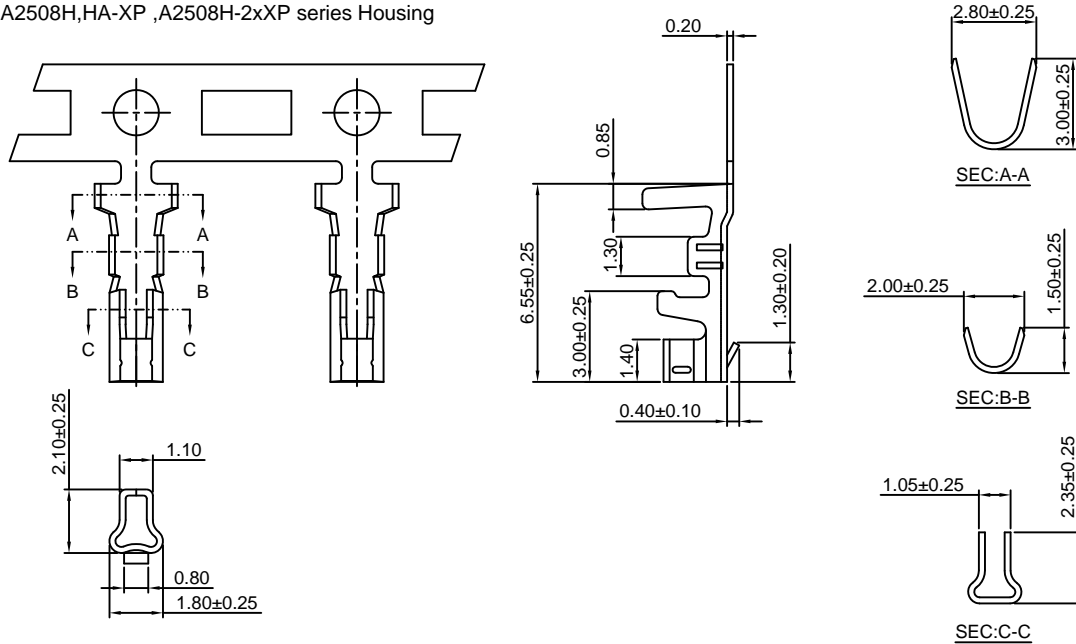

Ordering information & Specifications:

Unit:mm

Part NO	Wire Range	Insulation O.D.	Material	Finish	Qty/reel
A2508-TP	AWG#22-#26	1.90mm(max)	Phosphor Bronze	Tin over Nickel	10,000 PCS
A2508-GP	AWG#22-#26	1.90mm(max)	Phosphor Bronze	Gold over Nickel	10,000 PCS

Optional Gold plating available but MOQ requested

A2508-T-L

2.50mm Pitch Crimp Terminal

Reference Informations:

*Used in CJT A2508H,HA-XP ,A2508H-2xXP series Housing

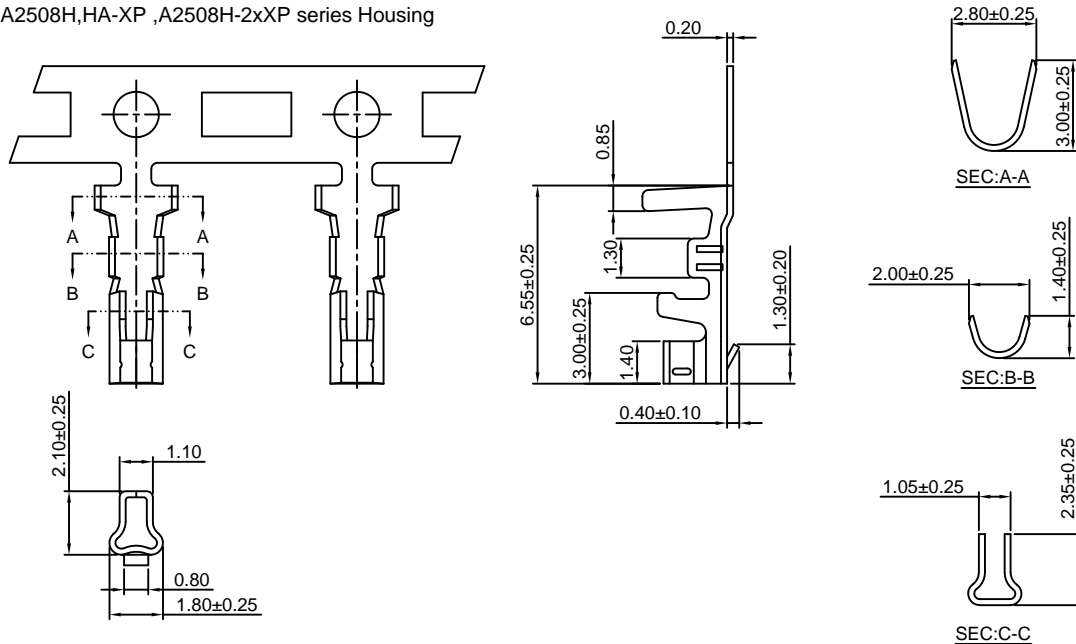

Ordering information & Specifications:

Unit:mm

Part NO	Wire Range	Insulation O.D.	Material	Finish	Qty/reel
A2508-TP-L	AWG#22-#28	1.90mm(max)	Phosphor Bronze	Tin over Nickel	10,000 PCS
A2508-GP-L	AWG#22-#28	1.90mm(max)	Phosphor Bronze	Gold over Nickel	10,000 PCS

Optional Gold plating available but MOQ requested

A2508-T-H

2.50mm Pitch Crimp Terminal

Reference Informations:

*Used in CJT A2508H,HA-XP ,A2508H-2xXP series Housing

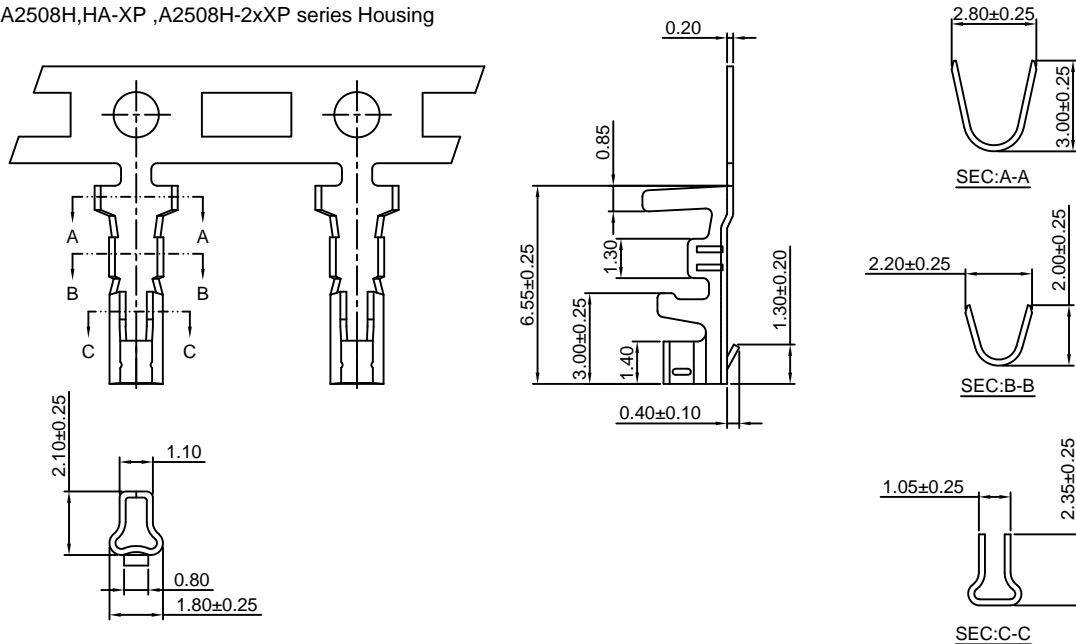

Ordering information & Specifications:

Unit:mm

Part NO	Wire Range	Insulation O.D.	Material	Finish	Qty/reel
A2508-TP-H	AWG#20-#24	1.90mm(max)	Phosphor Bronze	Tin over Nickel	10,000 PCS
A2508-GP-H	AWG#20-#24	1.90mm(max)	Phosphor Bronze	Gold over Nickel	10,000 PCS

Optional Gold plating available but MOQ requested

A2508M-T

2.50mm Pitch Crimp Terminal

Reference Informations:

*Used in CJT A2508HMA-XP series Housing

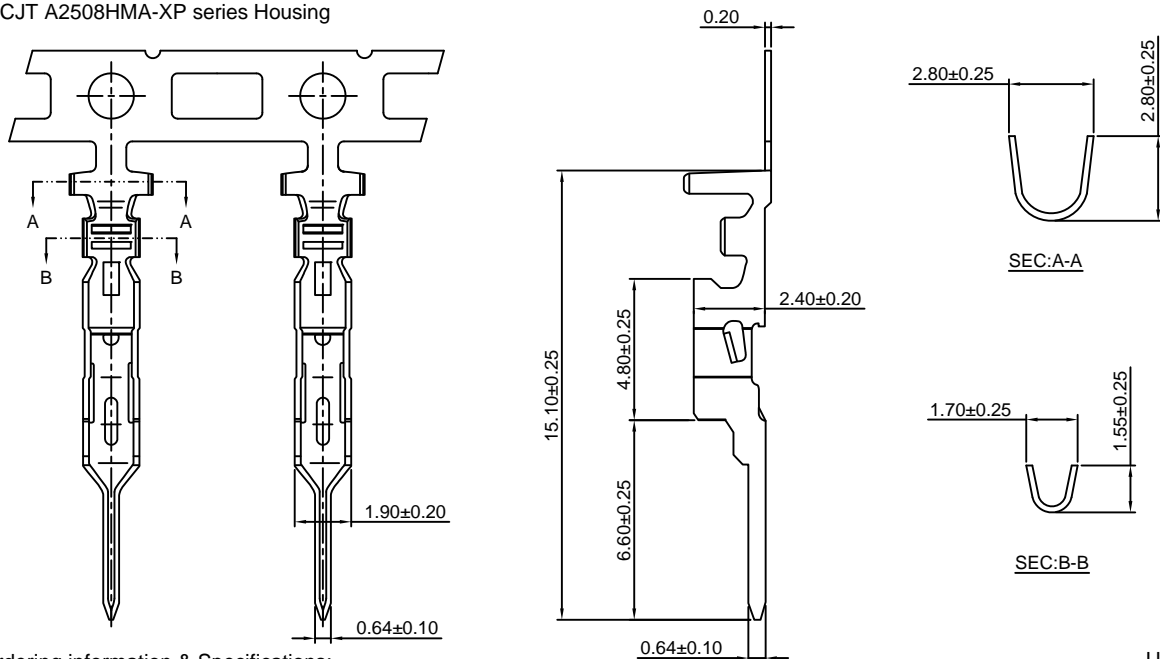

Ordering information & Specifications:

Unit:mm

Part NO	Wire Range	Insulation O.D.	Material	Finish	Qty/reel
A2508M-TP	AWG#22-#28	1.90mm(max)	Phosphor Bronze	Tin over Nickel	7,000 PCS
A2508M-GP	AWG#22-#28	1.90mm(max)	Phosphor Bronze	Gold over Nickel	7,000 PCS

Optional Gold plating available but MOQ requested

A2508H-XP

2.50mm Pitch Housing

Reference Informations:

- *Material:Nylon 66,UL94V-0
- *Suitable CJT A2508-T series Terminal
- *Mates with CJT A2508WV,WV-F-XP(-H), A2508WR,WR-F-XP,A2508WV-S-XP,A2508WVT-XP(-H), A2508WVT-F-XP(-H) series Wafer
- *Color:White

Ordering Information:

- A2508H-XP - *** - **
 1 2 3
- Part No.
 - Material:
 (blank):Nylon 66,UL94V-0
 GWT:Nylon 66,UL94V-0,GWT 750 °C
 - Color:
 (Blank):White
 RD:Red
 YL:Yellow
 BL:Blue
 BK:Black
 GN:Green
 IV:Ivory
 LE:Light blue
 OR:Orange
 GY:Gray
 PK:Pink
 BR:Brown
 VI:Violet
 LY:Lemon yellow
 VY:Vivid yellow

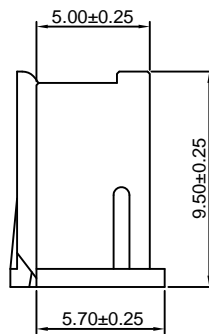
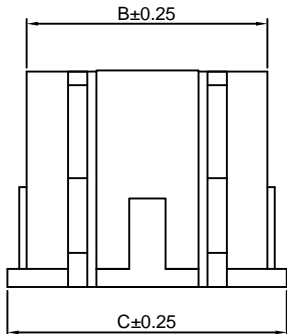
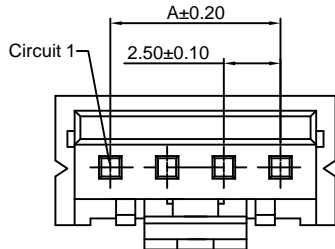
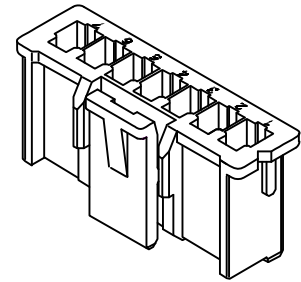

Ordering Information & Dimensions:

PART NO.	Dimensions		
	A	B	C
2P	2.50	5.64	7.30
3P	5.00	8.14	9.80
4P	7.50	10.64	12.30
5P	10.00	13.14	14.80
6P	12.50	15.64	17.30
7P	15.00	18.14	19.80
8P	17.50	20.64	22.30
9P	20.00	23.14	24.80
10P	22.50	25.64	27.30
11P	25.00	28.14	29.80
12P	27.50	30.64	32.30
13P	30.00	33.14	34.80
14P	32.50	35.64	37.30
15P	35.00	38.14	39.80

Unit: mm

A2508HA-XP

2.50mm Pitch Housing

Reference Informations:

- *Material:Nylon 66,UL94V-0
- *Suitable CJT A2508-T series Terminal
- *Mates with CJT A2508HMA-XP series Housing and A2508SA-XP series Seal and A2508WV,WV-F-XP(-H),A2508WR,WR-F-XP,A2508WV-S-XP, A2508WVT-XP(-H),A2508WVT-F-XP(-H) series Wafer
- *Color:White

Ordering Information:

- A2508HA-XP - *** - **
 1 2 3
- Part No.
 - Material:
 (blank):Nylon 66,UL94V-0
 GWT:Nylon 66,UL94V-0 , GWT 750 °C
 - Color:
 (blank) : White
 BK:Black
 RD:Red
 BL:Blue
 LY:Lemon yellow

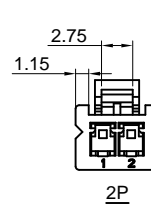
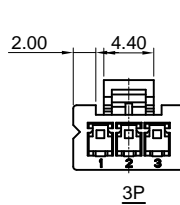
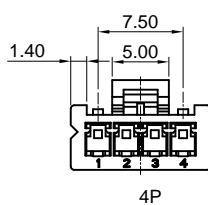
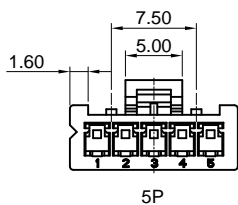
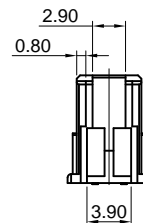
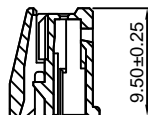
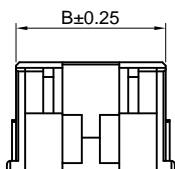
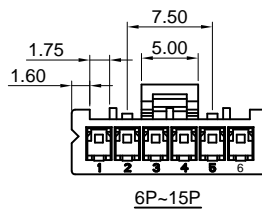
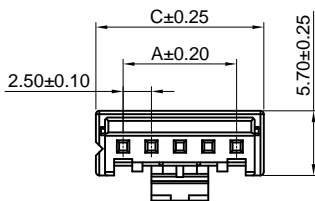

Ordering Information & Dimensions:

PART NO.	Dimensions		
	A	B	C
2P	2.50	5.70	7.30
3P	5.00	8.20	9.80
4P	7.50	10.70	12.30
5P	10.00	13.20	14.80
6P	12.50	15.70	17.30
7P	15.00	18.20	19.80
8P	17.50	20.70	22.30
9P	20.00	23.20	24.80
10P	22.50	25.70	27.30
11P	25.00	28.20	29.80
12P	27.50	30.70	32.30
13P	30.00	33.20	34.80
14P	32.50	35.70	37.30
15P	35.00	38.20	39.80

Unit: mm

A2508HMA-XP

2.50mm Pitch Housing

Reference Informations:

- *Material: Nylon 66, UL94V-0
- *Suitable CJT A2508M-T series Terminal
- *Mates with CJT A2508H, HA-XP series Housing
- *Color: White

Ordering Information:

- A2508HMA-XP - *** - **
 $\frac{1}{2} \frac{3}{3}$
1. Part No.
 2. Material:
 (blank): Nylon 66, UL94V-0
 GWT: Nylon 66, UL94V-0, GWT 750°C
 3. Color:
 (Blank): White
 RD: Red OR: Orange
 YL: Yellow GY: Gray
 BL: Blue PK: Pink
 BK: Black BR: Brown
 GN: Green VI: Violet

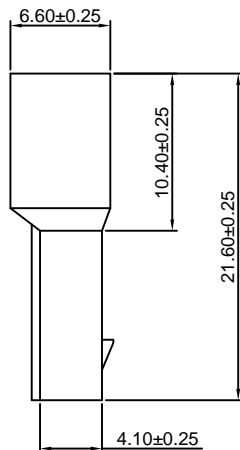
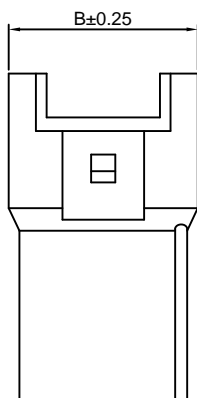
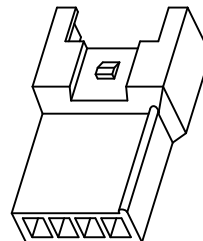
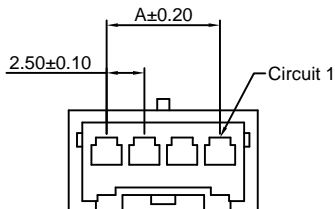

Ordering Information & Dimensions:

PART NO.	Dimensions	
	A	B
2P	2.50	7.50
3P	5.00	10.00
4P	7.50	12.50
5P	10.00	15.00
6P	12.50	17.50
7P	15.00	20.00
8P	17.50	22.50
9P	20.00	25.00
10P	22.50	27.50
11P	25.00	30.00
12P	27.50	32.50
13P	30.00	35.00
14P	32.50	37.50
15P	35.00	40.00

Unit: mm

A2508SA-XP

2.50mm Pitch Seal

Reference Informations:

- *Material: Nylon 66, UL94V-0
- *Mates with CJT A2508HA-XP series Housing
- *Color: Ivory

Ordering Information:

- A2508SA-XP - ***
 $\frac{1}{2}$
1. Part No.
 2. Material:
 (blank): Nylon 66, UL94V-0
 GWT: Nylon 66, UL94V-0, GWT 750°C

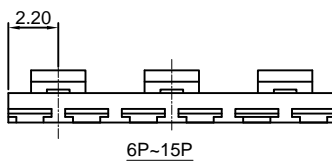
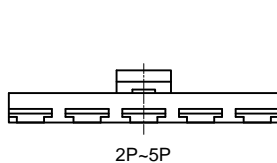
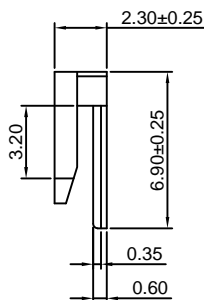
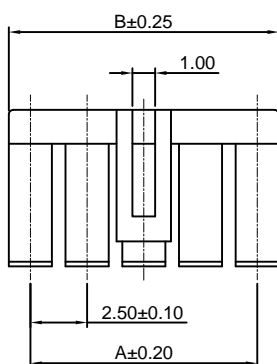

Ordering Information & Dimensions:

PART NO.	Dimensions	
	A	B
2P	2.50	4.40
3P	5.00	6.90
4P	7.50	9.40
5P	10.00	11.90
6P	12.50	14.40
7P	15.00	16.90
8P	17.50	19.40
9P	20.00	21.90
10P	22.50	24.40
11P	25.00	26.90
12P	27.50	29.40
13P	30.00	31.90
14P	32.50	34.40
15P	35.00	36.90

Unit: mm

A2508WV-XP

2.50mm Pitch 180° Wafer

Reference Informations:

- *Material: Pin: Brass/Tin over Nickel
Insulator: Nylon 66, UL94V-0
- *Mates with CJT A2508H, HA-XP series Housing
- *Color: Ivory

Ordering Information:

A2508WV-XP - *** - ** - **
1 2 3 4

- Part No.
- Material:
(blank): Nylon 66, UL94V-0
GWT: Nylon 66, UL94V-0, GWT 750°C
- Color:
(Blank): Ivory
RD: Red OR: Orange
YL: Yellow GY: Gray
BL: Blue PK: Pink
BK: Black BR: Brown
GN: Green VI: Violet
WH: White LY: Lemon yellow
LE: Light blue VY: Vivid yellow
- Finish:
(blank): Tin over Nickel
G: Gold over Nickel

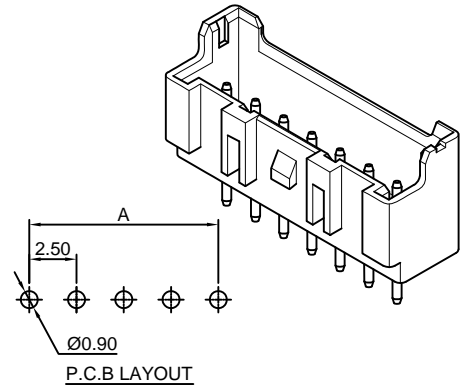
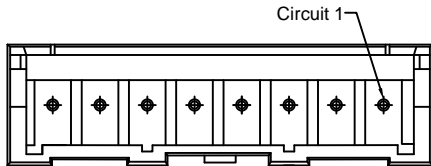

Ordering Information & Dimensions:

PART NO.	Dimensions	
	A	B
2P	2.50	7.50
3P	5.00	10.00
4P	7.50	12.50
5P	10.00	15.00
6P	12.50	17.50
7P	15.00	20.00
8P	17.50	22.50
9P	20.00	25.00
10P	22.50	27.50
11P	25.00	30.00
12P	27.50	32.50
13P	30.00	35.00
14P	32.50	37.50
15P	35.00	40.00

Unit: mm

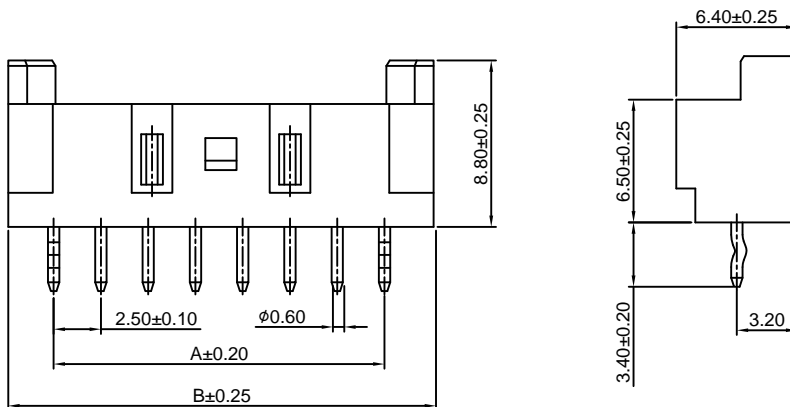

A2508WR-XP

2.50mm Pitch 90° Wafer

Reference Informations:

- *Material: Pin: Brass/Tin over Nickel
Insulator: Nylon 66, UL94V-0
- *Mates with CJT A2508H, HA-XP series Housing
- *Color: Ivory

Ordering Information:

A2508WR-XP - *** - ** - **
1 2 3 4

- Part No.
- Material:
(blank): Nylon 66, UL94V-0
GWT: Nylon 66, UL94V-0, GWT 750°C
- Color:
(Blank): Ivory
RD: Red OR: Orange
YL: Yellow GY: Gray
BL: Blue PK: Pink
BK: Black BR: Brown
GN: Green VI: Violet
WH: White LY: Lemon yellow
LE: Light blue VY: Vivid yellow
- Finish:
(blank): Tin over Nickel
G: Gold over Nickel

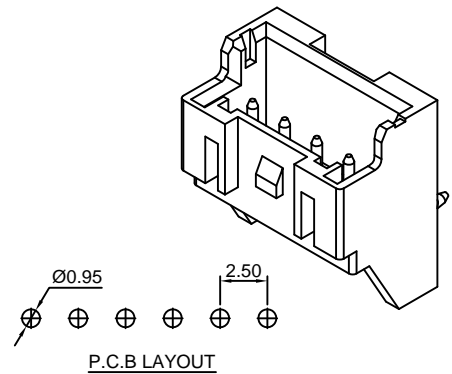
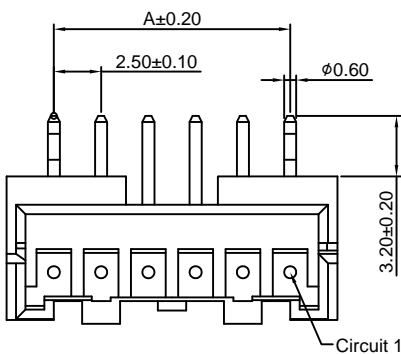

Ordering Information & Dimensions:

PART NO.	Dimensions	
	A	B
2P	2.50	7.50
3P	5.00	10.00
4P	7.50	12.50
5P	10.00	15.00
6P	12.50	17.50
7P	15.00	20.00
8P	17.50	22.50
9P	20.00	25.00
10P	22.50	27.50
11P	25.00	30.00
12P	27.50	32.50
13P	30.00	35.00
14P	32.50	37.50
15P	35.00	40.00

Unit: mm

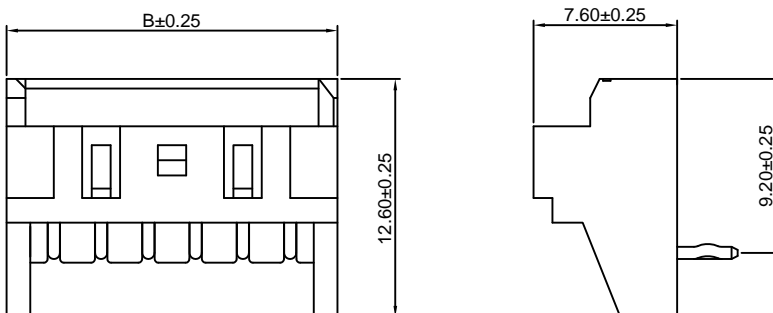

A2508WV-F-XP

2.50mm Pitch 180° Wafer

Reference Informations:

- *Material: Pin: Brass/Tin over Nickel
Insulator: Nylon 66, UL94V-0
- *Mates with CJT A2508H, HA-XP series Housing
- *Color: Ivory

Ordering Information:

A2508WV-F-XP - *** - ** - **
1 2 3 4

- Part No.
- Material:
(blank): Nylon 66, UL94V-0
GWT: Nylon 66, UL94V-0, GWT 750 °C
- Color:
(Blank): Ivory
RD: Red OR: Orange
YL: Yellow GY: Gray
BL: Blue PK: Pink
BK: Black BR: Brown
GN: Green VI: Violet
WH: White LY: Lemon yellow
LE: Light blue VY: Vivid yellow
- Finish:
(blank): Tin over Nickel
G: Gold over Nickel

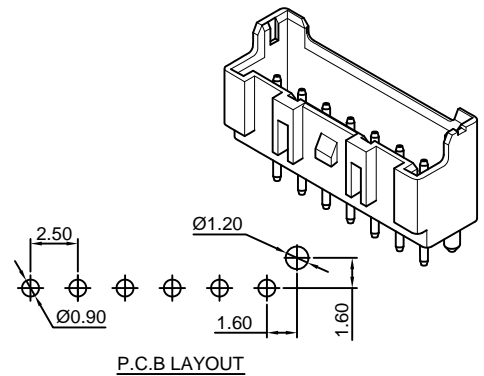
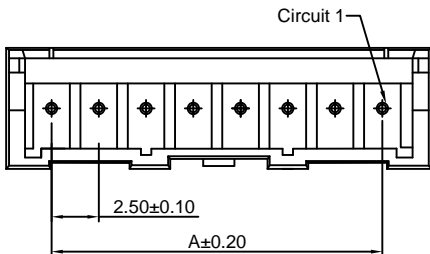

P.C.B LAYOUT

Ordering Information & Dimensions:

PART NO.	Dimensions	
	A	B
2P	2.50	7.50
3P	5.00	10.00
4P	7.50	12.50
5P	10.00	15.00
6P	12.50	17.50
7P	15.00	20.00
8P	17.50	22.50
9P	20.00	25.00
10P	22.50	27.50
11P	25.00	30.00
12P	27.50	32.50
13P	30.00	35.00
14P	32.50	37.50
15P	35.00	40.00

Unit: mm

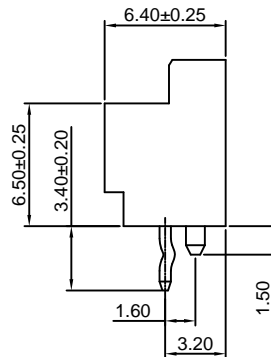
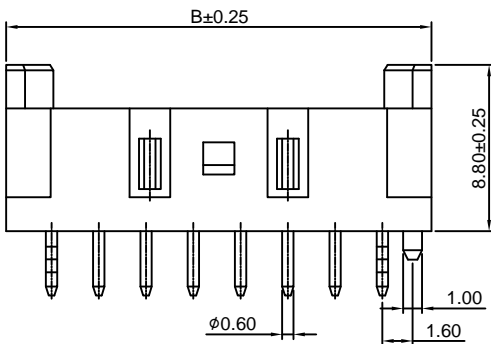

A2508WR-F-XP

2.50mm Pitch 90° Wafer

Reference Informations:

- *Material: Pin: Brass/Tin over Nickel
Insulator: Nylon 66, UL94V-0
- *Mates with CJT A2508H, HA-XP series Housing
- *Color: Ivory

Ordering Information:

A2508WR-F-XP - *** - ** - **
1 2 3 4

- Part No.
- Material:
(blank): Nylon 66, UL94V-0
GWT: Nylon 66, UL94V-0, GWT 750 °C
- Color:
(Blank): Ivory
RD: Red OR: Orange
YL: Yellow GY: Gray
BL: Blue PK: Pink
BK: Black BR: Brown
GN: Green VI: Violet
WH: White LY: Lemon yellow
LE: Light blue VY: Vivid yellow
- Finish:
(blank): Tin over Nickel
G: Gold over Nickel

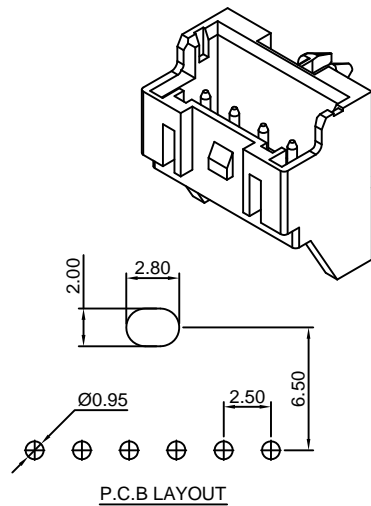
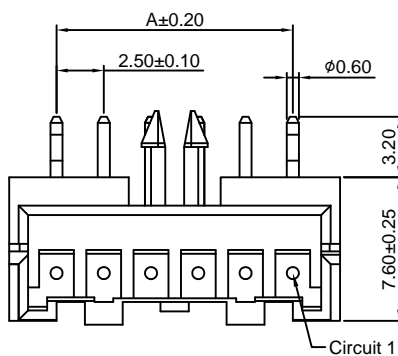

P.C.B LAYOUT

Ordering Information & Dimensions:

PART NO.	Dimensions	
	A	B
2P	2.50	7.50
3P	5.00	10.00
4P	7.50	12.50
5P	10.00	15.00
6P	12.50	17.50
7P	15.00	20.00
8P	17.50	22.50
9P	20.00	25.00
10P	22.50	27.50
11P	25.00	30.00
12P	27.50	32.50
13P	30.00	35.00
14P	32.50	37.50
15P	35.00	40.00

Unit: mm

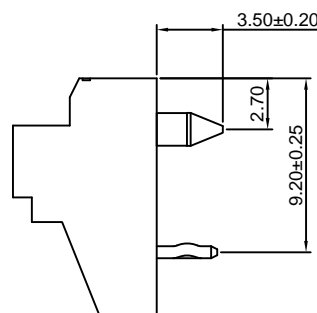
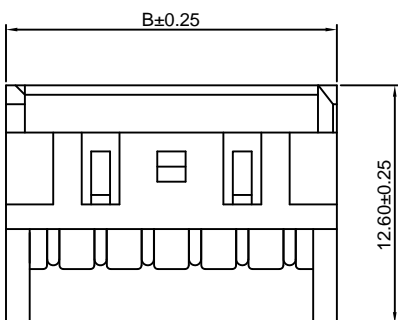

A2508WV-XP-H

2.50mm Pitch 180° Wafer-High box type

Reference Informations:

- *Material: Pin: Brass/Tin over Nickel
Insulator: Nylon 66, UL94V-0
- *Mates with CJT A2508H, HA-XP series Housing
- *Color: Ivory

- Ordering Information:
A2508WV-XP-H - *** - ** - **
1 2 3 4
1. Part No.
 2. Material:
(blank): Nylon 66, UL94V-0
GWT: Nylon 66, UL94V-0, GWT 750 °C
 3. Color:
(blank): Ivory
BK: Black
RD: Red
YL: Yellow
GN: Green
 4. Finish:
(blank): Tin over Nickel
G: Gold over Nickel

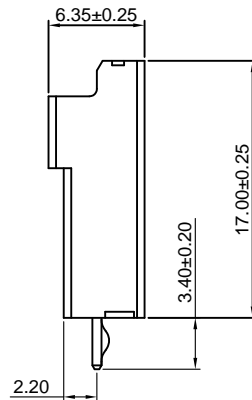
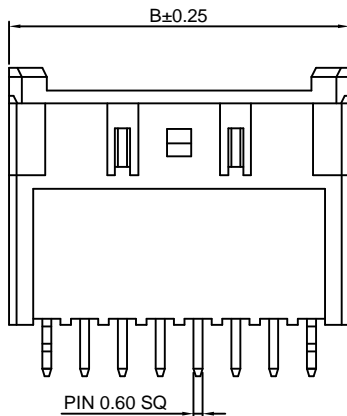
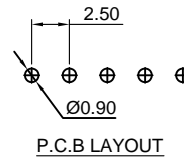
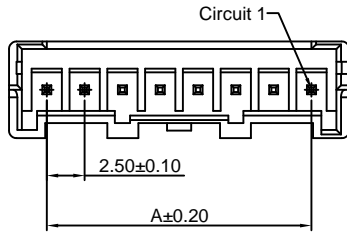
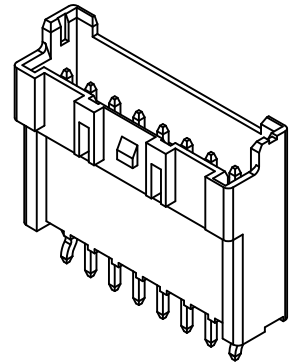

Ordering Information & Dimensions:

PART NO.	Dimensions	
	A	B
2P	2.50	7.50
3P	5.00	10.00
4P	7.50	12.50
5P	10.00	15.00
6P	12.50	17.50
7P	15.00	20.00
8P	17.50	22.50
9P	20.00	25.00
10P	22.50	27.50
11P	25.00	30.00
12P	27.50	32.50
13P	30.00	35.00
14P	32.50	37.50
15P	35.00	40.00

Unit: mm

A2508WV-F-XP-H

2.50mm Pitch 180° Wafer-High box type

Reference Informations:

- *Material: Pin: Brass/Tin over Nickel
Insulator: Nylon 66, UL94V-0
- *Mates with CJT A2508H, HA-XP series Housing
- *Color: Ivory

- Ordering Information:
A2508WV-F-XP-H - *** - ** - **
1 2 3 4
1. Part No.
 2. Material:
(blank): Nylon 66, UL94V-0
GWT: Nylon 66, UL94V-0, GWT 750 °C
 3. Color:
(blank): Ivory
BK: Black
RD: Red
YL: Yellow
GN: Green
 4. Finish:
(blank): Tin over Nickel
G: Gold over Nickel

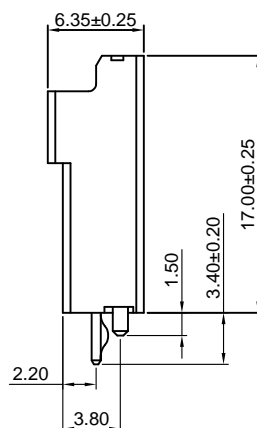
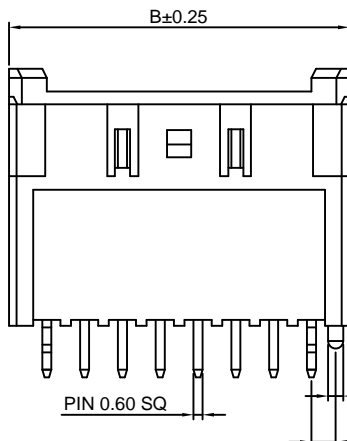
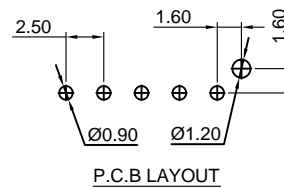
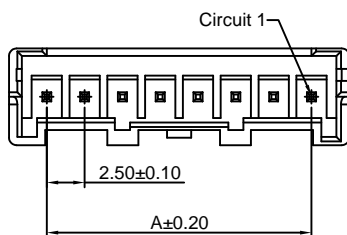
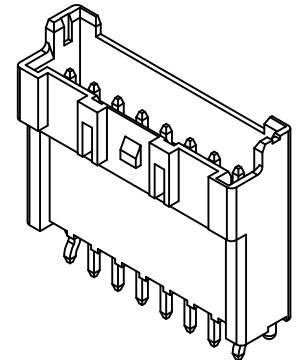

Ordering Information & Dimensions:

PART NO.	Dimensions	
	A	B
2P	2.50	7.50
3P	5.00	10.00
4P	7.50	12.50
5P	10.00	15.00
6P	12.50	17.50
7P	15.00	20.00
8P	17.50	22.50
9P	20.00	25.00
10P	22.50	27.50
11P	25.00	30.00
12P	27.50	32.50
13P	30.00	35.00
14P	32.50	37.50
15P	35.00	40.00

Unit: mm

A2508WV-S-XP

2.50mm Pitch 180° Wafer - SMT TYPE

Reference Informations:

- *Material: Pin: Brass/Tin over Nickel
Insulator: Nylon 9T, UL94V-0
- *Mates with CJT A2508H, HA-XP series Housing
- *Color: Ivory

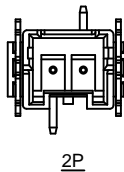
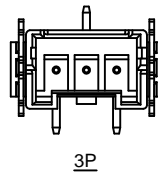
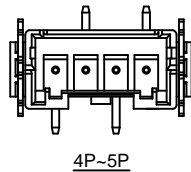
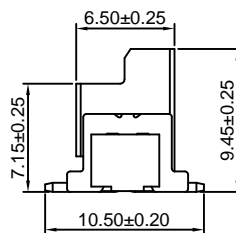
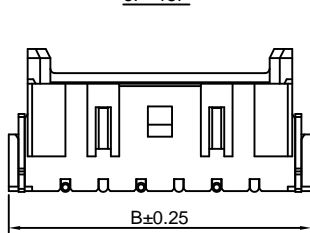
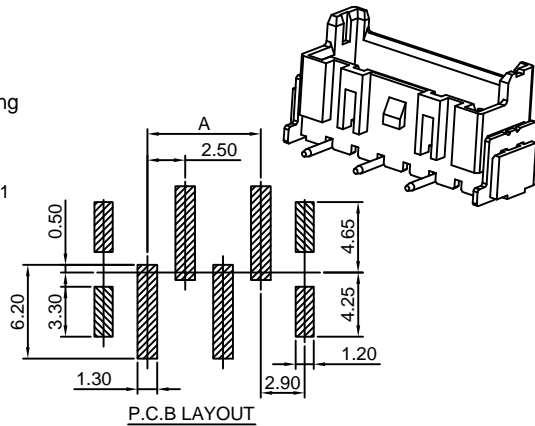
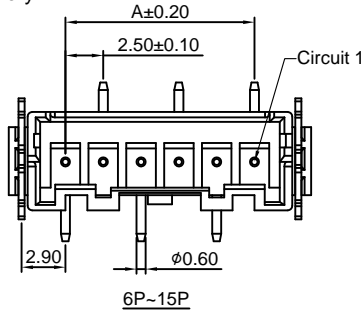

Ordering Information:

A2508WV-S-XP - *** - ** - **
1 2 3 4

- Part No.
- Material:
(blank): Nylon 66, UL94V-0
GWT: Nylon 66, UL94V-0, GWT 750°C
- Color:
(Blank): Ivory
RD: Red OR: Orange
BL: Blue BK: Black
GN: Green LY: Lemon yellow
- Finish:
(blank): Tin over Nickel
G: Gold over Nickel

Ordering Information & Dimensions:

PART NO.	Dimensions	
	A	B
2P	2.50	10.00
3P	5.00	12.50
4P	7.50	15.00
5P	10.00	17.50
6P	12.50	20.00
7P	15.00	22.50
8P	17.50	25.00
9P	20.00	27.50
10P	22.50	30.00
11P	25.00	32.50
12P	27.50	35.00
13P	30.00	37.50
14P	32.50	40.00
15P	35.00	42.50

Unit: mm

A2508H-2xXP

2.50mm Pitch Dual Row Housing

Reference Informations:

- *Material: Nylon 66, UL94V-0
- *Suitable CJT A2508-T series Terminal
- *Mates with CJT A2508WV, WV-F-2xXP series Wafer
- *Color: White

Ordering Information:

A2508H-2xXP - *** - **
1 2 3

- Part No.
- Material:
(blank): Nylon 66, UL94V-0
GWT: Nylon 66, UL94V-0, GWT 750°C
- Color:
(Blank): White
BK: Black
RD: Red
BL: Blue
GN: Green
PK: Pink
LY: Lemon yellow

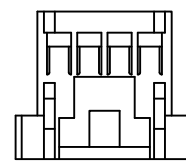
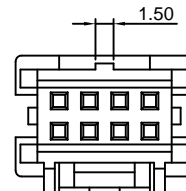
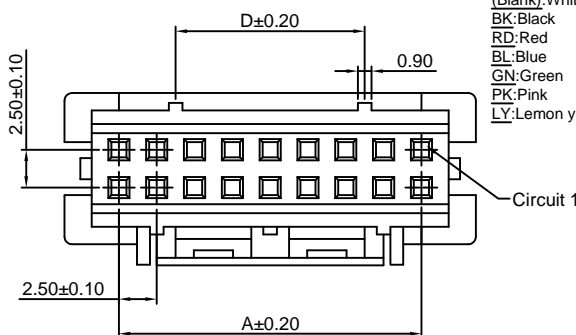

2x4P~2x8P

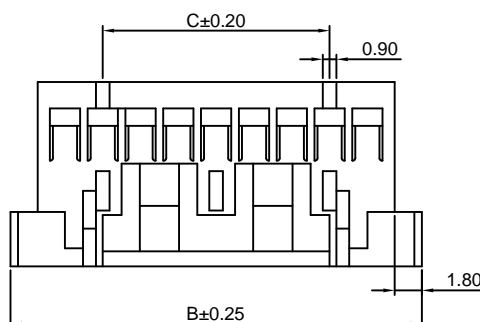

2x9P~2x20P

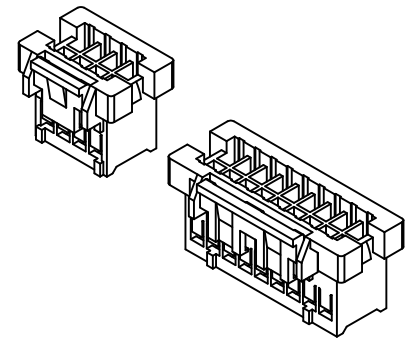
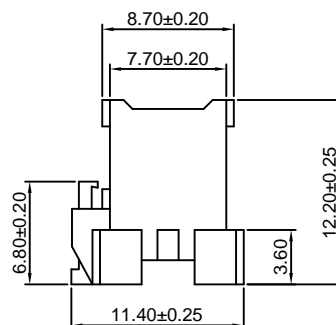

Ordering Information & Dimensions:

PART NO.	Dimensions			
	A	B	C	D
2x4P	7.50	14.70	9.10	----
2x5P	10.00	17.20	7.50	----
2x6P	12.50	19.70	10.00	----
2x7P	15.00	22.20	12.50	----
2x8P	17.50	24.70	15.00	----
2x9P	20.00	27.20	15.00	12.50
2x10P	22.50	29.70	17.50	15.00
2x11P	25.00	32.20	20.00	17.50
2x12P	27.50	34.70	22.50	20.00
2x13P	30.00	37.20	25.00	22.50
2x14P	32.50	39.70	27.50	25.00
2x15P	35.00	42.20	30.00	27.50
2x16P	37.50	44.70	32.50	30.00
2x17P	40.00	47.20	35.00	32.50
2x18P	42.50	49.70	37.50	35.00
2x19P	45.00	52.20	40.00	37.50
2x20P	47.50	54.70	42.50	40.00

Unit: mm

A2508WV(-F)-2xXP

2.50mm Pitch Dual Row 180° Wafer

Reference Informations:

- *Material: Pin: Brass/Tin over Nickel
Insulator: Nylon 66, UL94V-0
- *Mates with CJT A2508H-2xXP series Housing
- *Color: Ivory

Ordering Information:
A2508WV(-F)-2xXP - *** - **
1 2 3

1. Part No.
2. Material:
(blank): Nylon 66, UL94V-0
GWT: Nylon 66, UL94V-0, GWT 750 °C
3. Color:
(Blank): White
BK: Black
RD: Red
BL: Blue
GN: Green
PK: Pink
LY: Lemon yellow

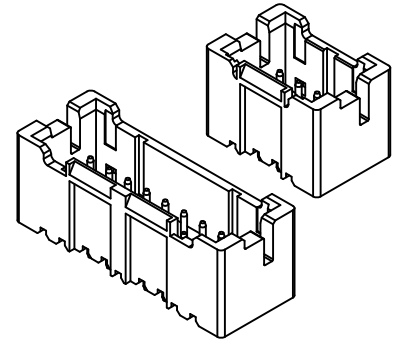
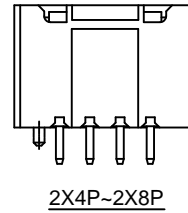
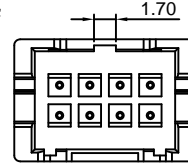
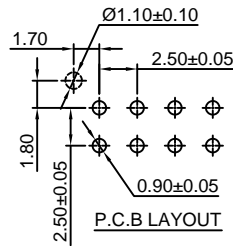
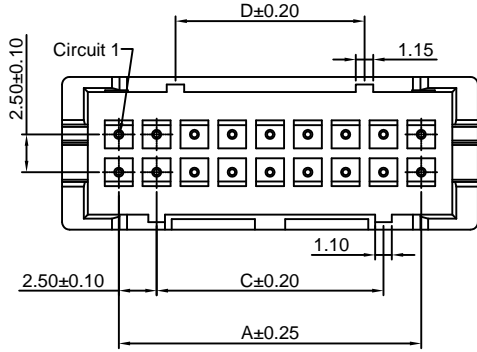

Ordering Information & Dimensions:

PART NO.	Dimensions			
	A	B	C	D
2x4P	7.50	14.70	9.10	----
2x5P	10.00	17.20	7.50	----
2x6P	12.50	19.70	10.00	----
2x7P	15.00	22.20	12.50	----
2x8P	17.50	24.70	15.00	----
2x9P	20.00	27.20	15.00	12.50
2x10P	22.50	29.70	17.50	15.00
2x11P	25.00	32.20	20.00	17.50
2x12P	27.50	34.70	22.50	20.00
2x13P	30.00	37.20	25.00	22.50
2x14P	32.50	39.70	27.50	25.00
2x15P	35.00	42.20	30.00	27.50
2x16P	37.50	44.70	32.50	30.00
2x17P	40.00	47.20	35.00	32.50
2x18P	42.50	49.70	37.50	35.00
2x19P	45.00	52.20	40.00	37.50
2x20P	47.50	54.70	42.50	40.00

Unit: mm

2X9P~2X21P

A2508WR-F-2xXP

2.50mm Pitch Dual Row 90° Wafer

Reference Informations:

- *Material: Pin: Brass/Tin over Nickel
Insulator: Nylon 66, UL94V-0
- *Mates with CJT A2508H-2xXP series Housing
- *Color: Ivory

Ordering Information:
A2508WR-F-2xXP - *** - **
1 2 3

1. Part No.
2. Material:
(blank): Nylon 66, UL94V-0
GWT: Nylon 66, UL94V-0, GWT 750 °C
3. Color:
(Blank): White
BK: Black
RD: Red
BL: Blue
GN: Green
PK: Pink
LY: Lemon yellow

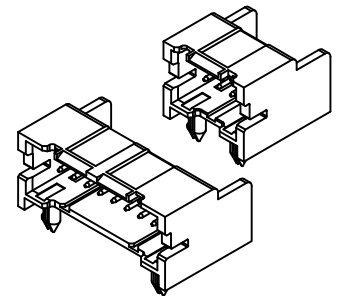
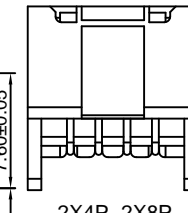
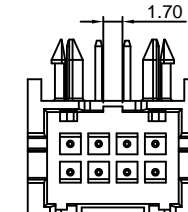
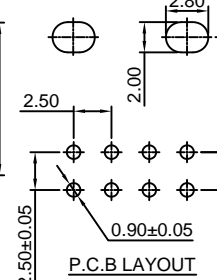
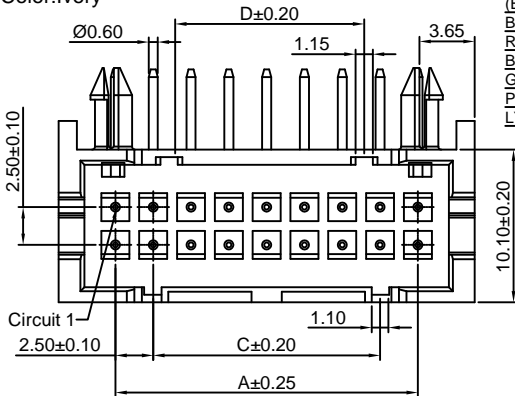

Ordering Information & Dimensions:

PART NO.	Dimensions			
	A	B	C	D
2x4P	7.50	14.70	9.10	----
2x5P	10.00	17.20	7.50	----
2x6P	12.50	19.70	10.00	----
2x7P	15.00	22.20	12.50	----
2x8P	17.50	24.70	15.00	----
2x9P	20.00	27.20	15.00	12.50
2x10P	22.50	29.70	17.50	15.00
2x11P	25.00	32.20	20.00	17.50
2x12P	27.50	34.70	22.50	20.00
2x13P	30.00	37.20	25.00	22.50
2x14P	32.50	39.70	27.50	25.00
2x15P	35.00	42.20	30.00	27.50
2x16P	37.50	44.70	32.50	30.00
2x17P	40.00	47.20	35.00	32.50
2x18P	42.50	49.70	37.50	35.00
2x19P	45.00	52.20	40.00	37.50
2x20P	47.50	54.70	42.50	40.00

Unit: mm

2X9P~2X21P

A2508WVT(-F)-XP

2.50mm pitch 180° Wafer ON RADIAL-TAPE

Reference Informations:

- *Material: Pin: Brass/Tin over Nickel
Insulator: Nylon 66, UL94V-0
- *Mates with CJT A2508H, HA-XP series Housing
- *Color: Ivory

Ordering Information:

- A2508WVT(-F)-XP - *** - ** - **
1. Part No.
 2. Material:
(blank): Nylon 66, UL94V-0
GWT: Nylon 66, UL94V-0, GWT 750 °C
 3. Color:
(blank) : Ivory
BK : Black
RD : Red
BL : Blue
YL : Yellow
GN : Green
 4. Finish:
(blank): Tin over Nickel
G: Gold over Nickel

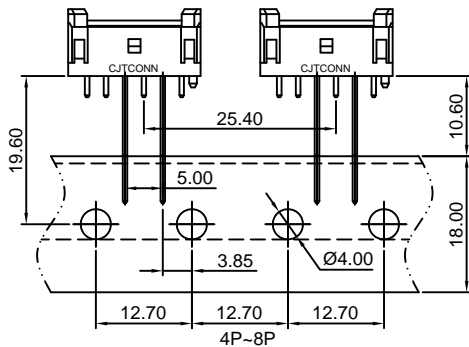
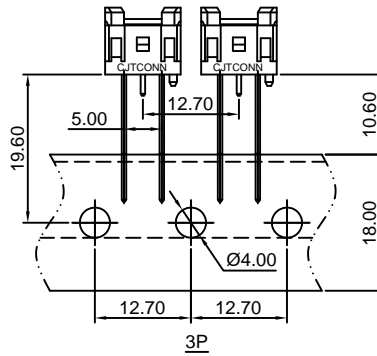
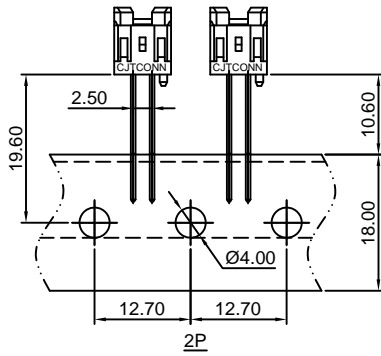
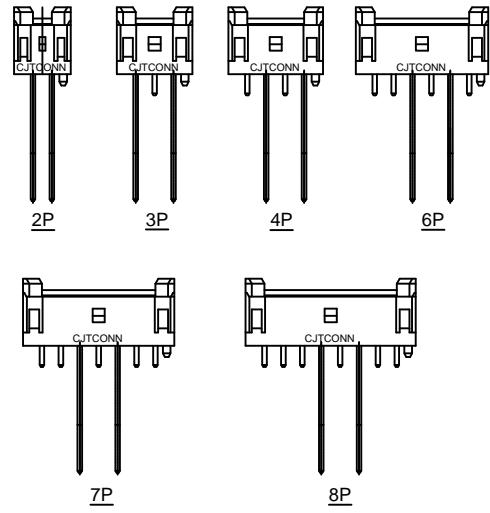
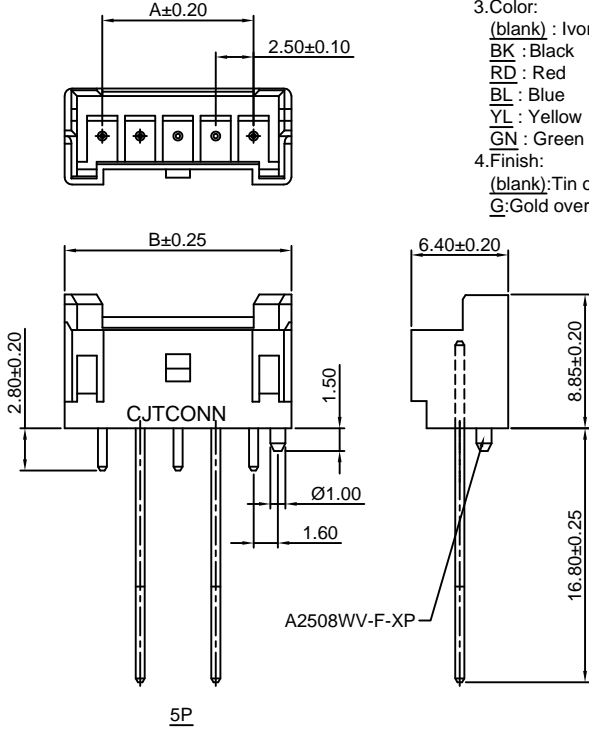
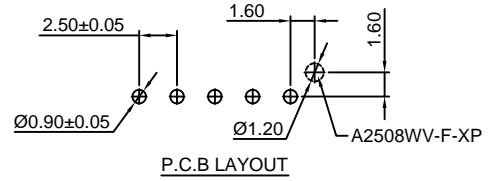

Ordering Information & Dimensions:

PART NO.	Dimensions	
	A	B
2P	2.50	7.50
3P	5.00	10.00
4P	7.50	12.50
5P	10.00	15.00
6P	12.50	17.50
7P	15.00	20.00
8P	17.50	22.50

Unit: mm

A2508WVT(-F)-XP-H

2.50mm pitch 180° Wafer ON RADIAL-TAPE

Reference Informations:

- *Material: Pin: Brass/Tin over Nickel
Insulator: Nylon 66, UL94V-0
- *Mates with CJT A2508H, HA-XP series Housing
- *Color: Ivory

Ordering Information:

A2508WVT(-F)-XP-H - *** - ** - **

1. Part No.
2. Material:
(blank): Nylon 66, UL94V-0
GWT: Nylon 66, UL94V-0, GWT 750 °C
3. Color:
(blank): Ivory
BK: Black
RD: Red
BL: Blue
YL: Yellow
GN: Green
4. Finish:
(blank): Tin over Nickel
G: Gold over Nickel

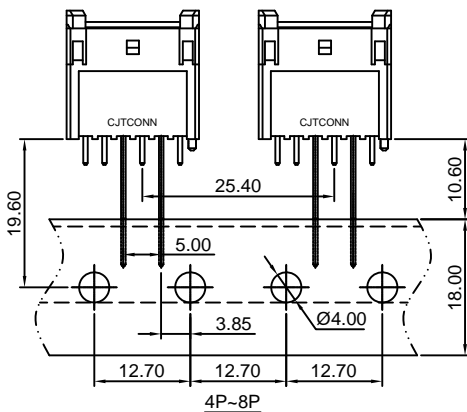
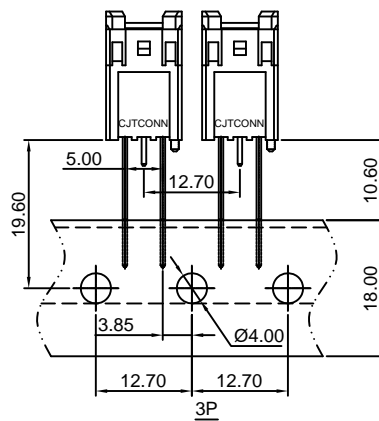
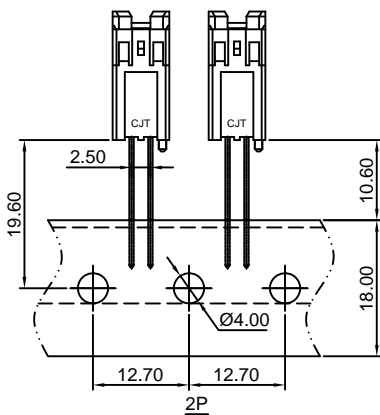
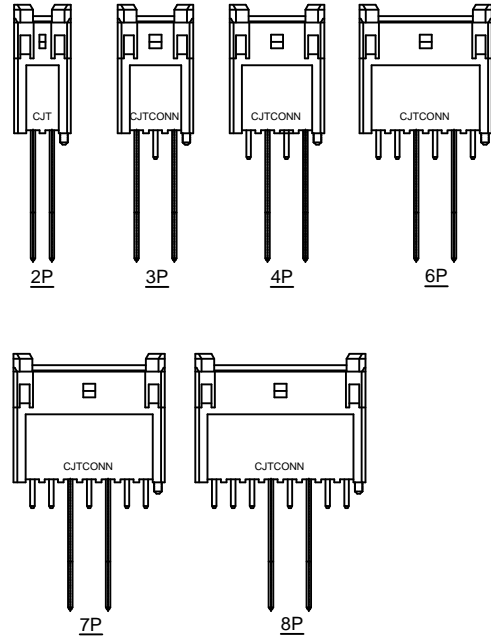
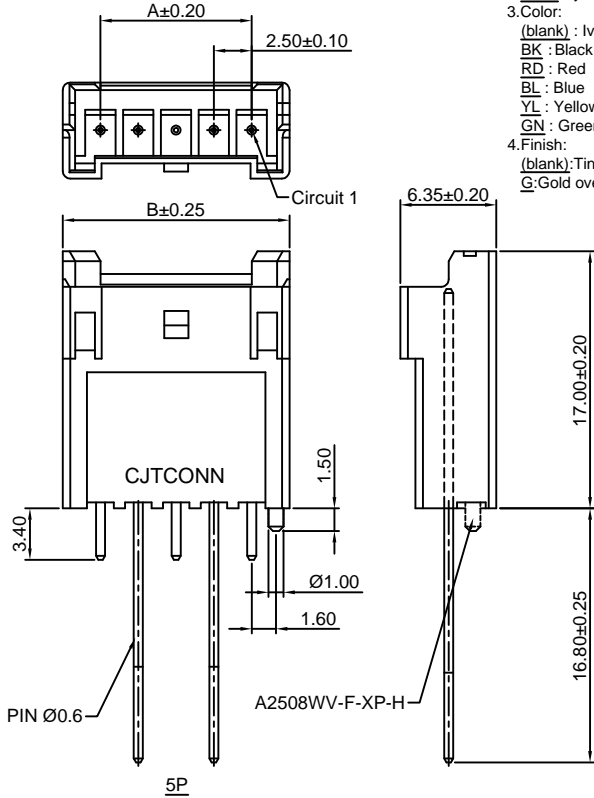
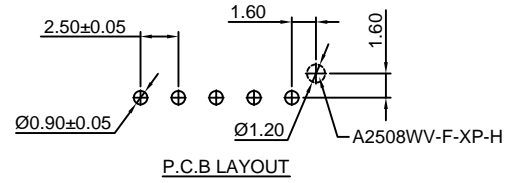

Ordering Information & Dimensions:

PART NO.	Dimensions	
	A	B
2P	2.50	7.50
3P	5.00	10.00
4P	7.50	12.50
5P	10.00	15.00
6P	12.50	17.50
7P	15.00	20.00
8P	17.50	22.50

Unit: mm

单击下面可查看定价，库存，交付和生命周期等信息

[>>CJTconn\(长江连接器\)](#)