

Specifications

Current rating:3A AC,DC
Voltage rating:250V AC,DC
Temperature range:-40°C~+105°C
Contact resistance:10mΩMax.
Insulation resistance:1000MΩMin.
Withstanding voltage:1000V AC/minute
Compliant with RoHS and REACH
Meet the HF/Halogen Free,need to customize
Contact CJT for details

Standards



Assembly layout

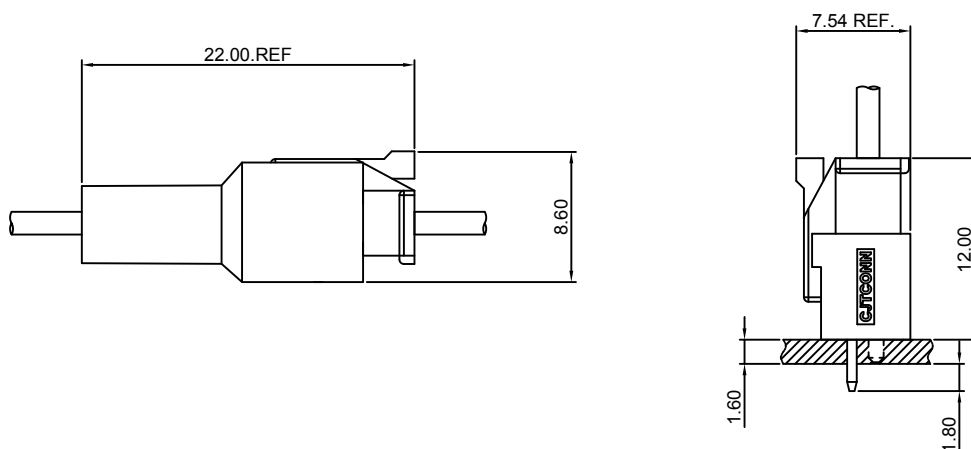

A2509-T-A

2.50mm Pitch Crimp Terminal

Reference Informations:

*Used in CJT A2509HA-XP, C2504HFA-XP series Housing

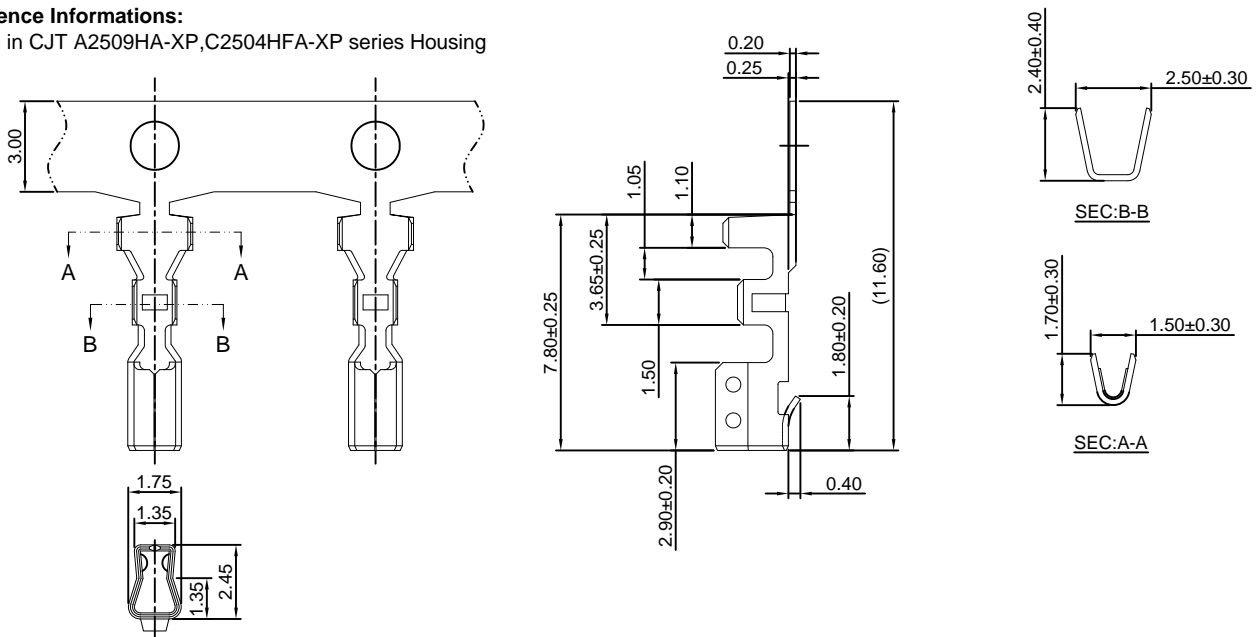

Ordering information & Specifications:

Unit:mm

Part NO.	Wire Range	Insulation O.D.	Material	Finish	Qty/reel
A2509-TP-A	AWG#22-#28	1.90mm(max)	Phosphor Bronze	Tin over Nickel	7,000 PCS
A2509-GP-A	AWG#22-#28	1.90mm(max)	Phosphor Bronze	Gold over Nickel	7,000 PCS

Optional Gold plating available but MOQ requested

A2509HA-XP

2.50mm Pitch Housing

Reference Informations:

*Material:Nylon 66 ,UL94V-0

*Suitable CJT A2509-T-A series Terminal

*Mates with CJT A2509HM-XP series Housing or A2509WV(-F)-XP series Wafer

*Color:White

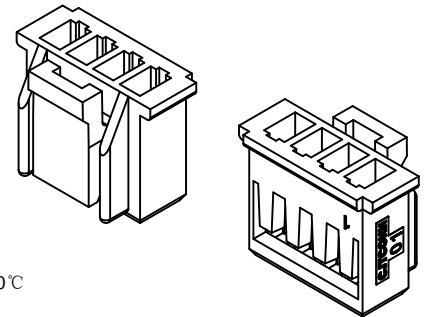

Ordering Information:

A2509HA-XP - ^{***} - ^{**}
1 2 3

1.Part No.

2.Material:

(blank):Nylon 66,UL94V-0

GWT:Nylon 66,UL94V-0,GWT 750 °C

3.Color:

(Blank):Natural

RD:Red

YL:Yellow

BL:Blue

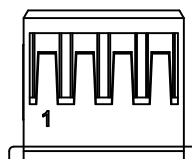
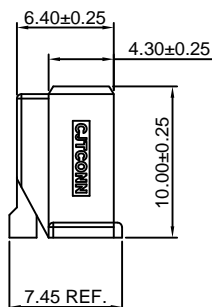
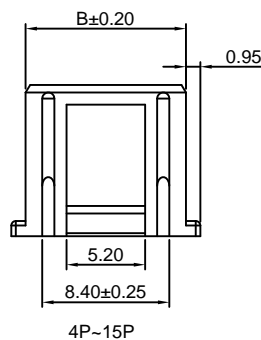
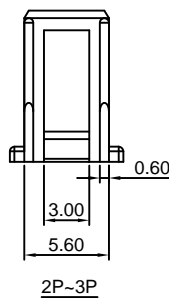
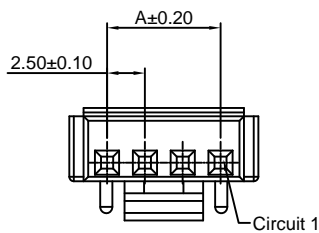

Ordering Information & Dimensions:

PART NO.	Dimensions	
	A	B
2P	2.50	5.60
3P	5.00	8.10
4P	7.50	10.60
5P	10.00	13.10
6P	12.50	15.60
7P	15.00	18.10
8P	17.50	20.60
9P	20.00	23.10
10P	22.50	25.60
11P	25.00	28.10
12P	27.50	30.60
13P	30.00	33.10
14P	32.50	35.60
15P	35.00	38.10

Unit: mm

A2509HM-XP

2.50mm Pitch Housing

Reference Informations:

- *Material: Nylon 66 ,UL94V-0
- *Suitable CJT A2501M-T series Terminal
- *Mates with CJT A2509HA-XP series Housing
- *Color: White

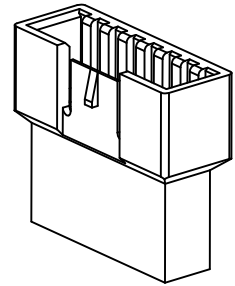

Ordering Information:

A2509HM-XP - ***
1 2

1. Part No.
2. Material:
(Blank): Nylon 66, UL94V-0
GWT: Nylon 66, UL94V-0, GWT 750 °C

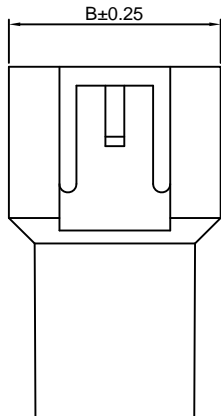
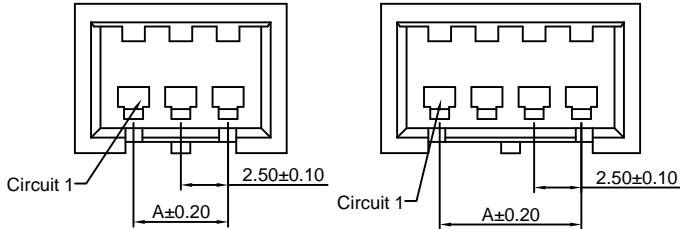

2P~3P

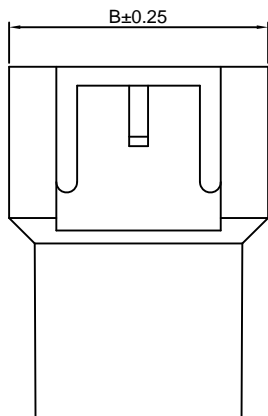

4P~15P

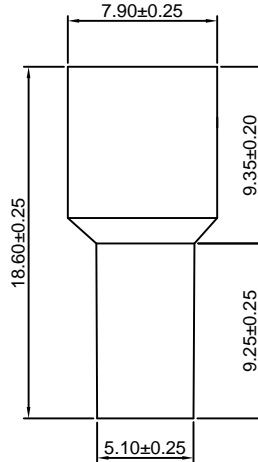

Ordering Information & Dimensions:

PART NO.	Dimensions	
	A	B
2P	2.50	8.70
3P	5.00	11.20
4P	7.50	13.70
5P	10.00	16.20
6P	12.50	18.70
7P	15.00	21.20
8P	17.50	23.70
9P	20.00	26.20
10P	22.50	28.70
11P	25.00	31.20
12P	27.50	33.70
13P	30.00	36.20
14P	32.50	38.70
15P	35.00	41.20

Unit: mm

A2509WV(-F)-XP

2.50mm Pitch 180° Wafer

Reference Informations:

- *Material: Pin: Brass/Tin over Nickel
Insulator: Nylon 66+20%GF, UL94V-0
- *Mates with CJT A2509HA-XP series Housing
- *Color: White

Ordering Information:

A2509WV(-F)-XP - *** - ** - **
1 2 3 4

1. Part No.
2. Material:
(blank): Nylon 66+20%GF, UL94V-0
GWT: Nylon 66, UL94V-0, GWT 750 °C
3. Color:
(Blank): White
RD: Red
YL: Yellow
BL: Blue
4. Finish:
(blank): Tin over Nickel
G: Gold over Nickel

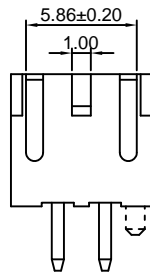
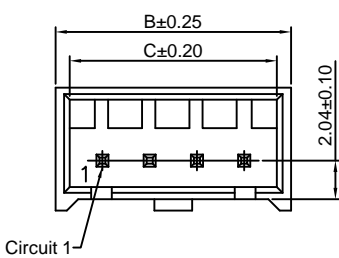
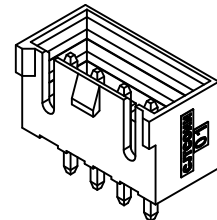

2P~3P

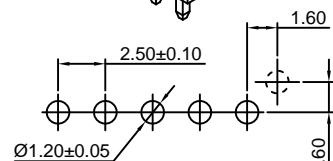

P.C.B LAYOUT

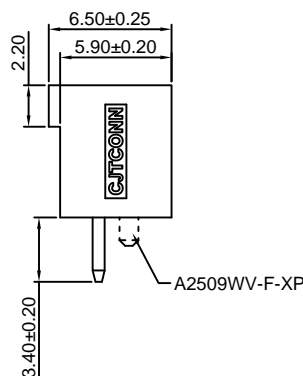
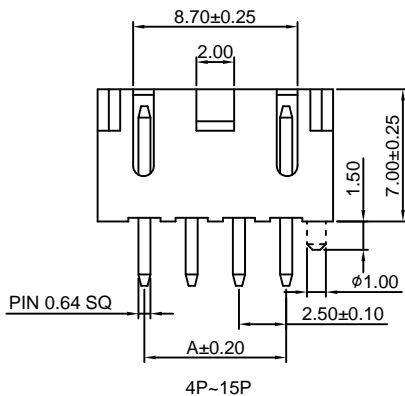

Ordering Information & Dimensions:

PART NO.	Dimensions		
	A	B	C
2P	2.50	7.46	5.96
3P	5.00	9.96	8.46
4P	7.50	12.46	10.96
5P	10.00	14.96	13.46
6P	12.50	17.46	15.96
7P	15.00	19.96	18.46
8P	17.50	22.46	20.96
9P	20.00	24.96	23.46
10P	22.50	27.46	25.96
11P	25.00	29.96	28.46
12P	27.50	32.46	30.96
13P	30.00	34.96	33.46
14P	32.50	37.46	35.96
15P	35.00	39.96	38.46

Unit: mm

单击下面可查看定价，库存，交付和生命周期等信息

[>>CJTconn\(长江连接器\)](#)