

Specifications

- Current rating:3A AC,DC
- Voltage rating:250V AC,DC
- Temperature range:-40°C~+105°C
- Contact resistance:10mΩMax.
- Insulation resistance:1000MΩMin.
- Withstanding voltage:800V AC/minute
- *Compliant with RoHS and REACH*
- *Meet the HF/Halogen Free,need to customize*
- *Contact CJT for details*

Standards

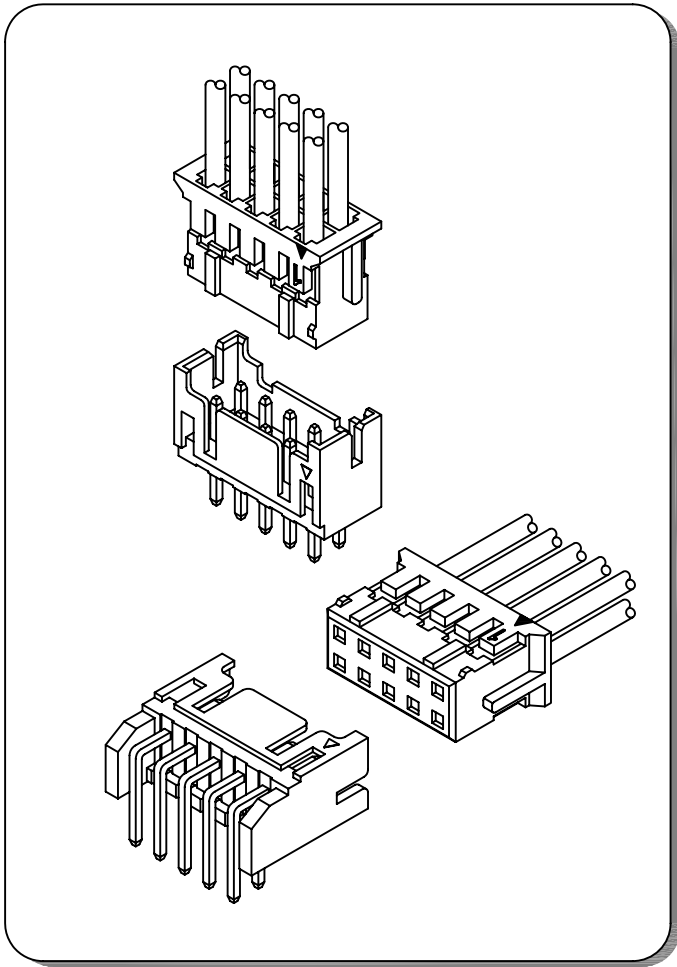

Assembly layout

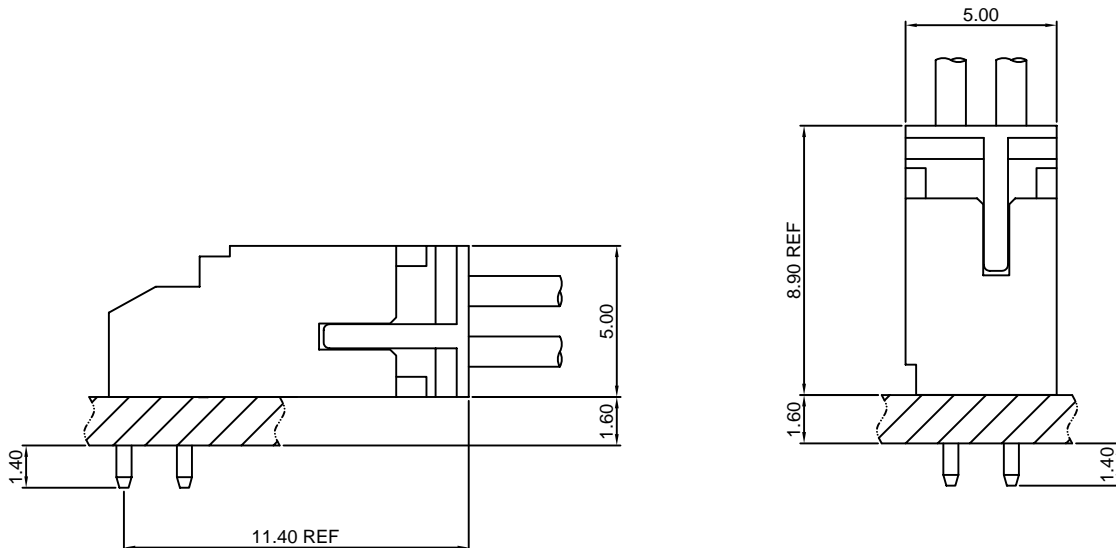

A2006-T

2.00mm pitch Crimp Terminal

Reference Informations:

*Used in CJT A2006H,HA-2xXP,A2012H-XP series Housing

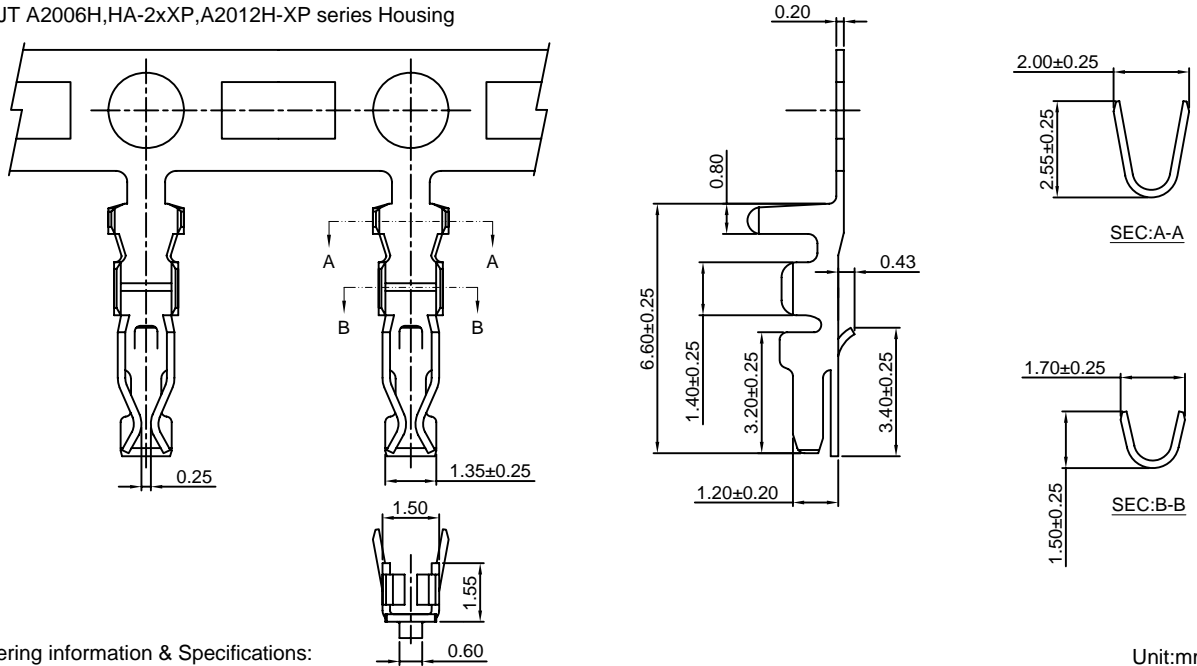

Ordering information & Specifications:

Unit:mm

Part NO.	Wire Range	Insulation O.D.	Material	Finish	Qty/reel
A2006-TP	AWG#22-#28	1.50mm(max)	Phosphor Bronze	Tin over Nickel	10,000 PCS
A2006-GP	AWG#22-#28	1.50mm(max)	Phosphor Bronze	Gold over flash	10,000 PCS

Optional Gold plating available but MOQ requested

A2006-T-B

2.00mm pitch Crimp Terminal

Reference Informations:

*Used in CJT A2006HB-2xXP series Housing

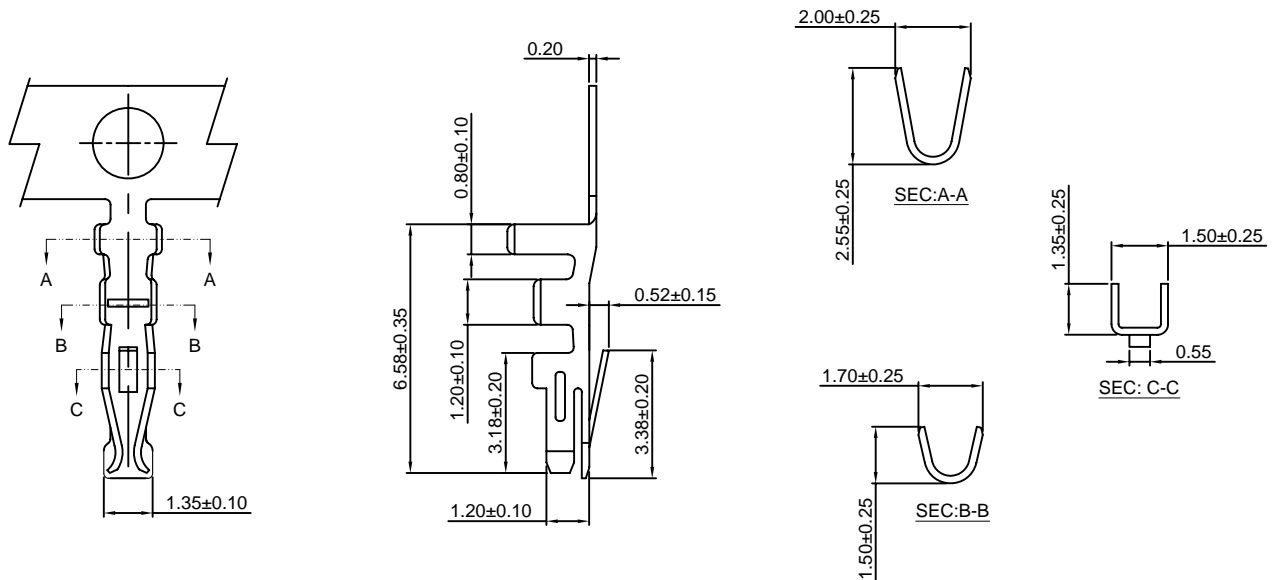

Ordering information & Specifications:

Unit:mm

Part NO.	Wire Range	Insulation O.D.	Material	Finish	Qty/reel
A2006-TP-B	AWG#22-#28	1.50mm(max)	Phosphor Bronze	Tin over Nickel	10,000 PCS
A2006-GP-B	AWG#22-#28	1.50mm(max)	Phosphor Bronze	Gold over flash	10,000 PCS

Optional Gold plating available but MOQ requested

A2006-T-U

2.00mm pitch Crimp Terminal

Reference Informations:

*Used in CJT A2006HU-2xXP series Housing

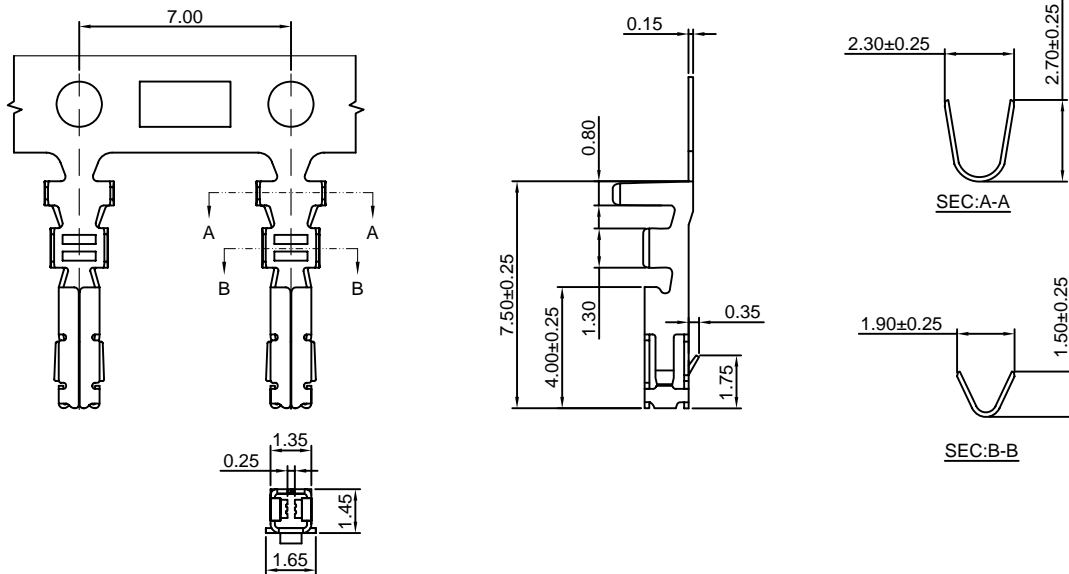

Ordering information & Specifications:

Unit:mm

Part NO.	Wire Range	Insulation O.D.	Material	Finish	Qty/reel
A2006-TP-U	AWG#22-#28	1.50mm(max)	Phosphor Bronze	Tin over Nickel	10,000 PCS
A2006-GP-U	AWG#22-#28	1.50mm(max)	Phosphor Bronze	Gold over flash	10,000 PCS

Optional Gold plating available but MOQ requested

A2006H-2xXP

2.00mm pitch Dual Row Housing

Reference Informations:

*Material:Nylon 66,UL94V-0

*Suitable CJT A2006-T series Terminal

*Mates with CJT A2006WV,WR,WV-S,WV-S-F-2xXP series Dual Row Wafer

*Color:White

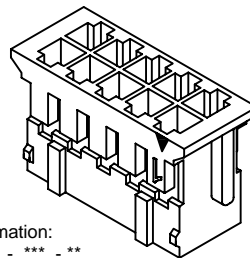

Ordering Information & Dimensions:

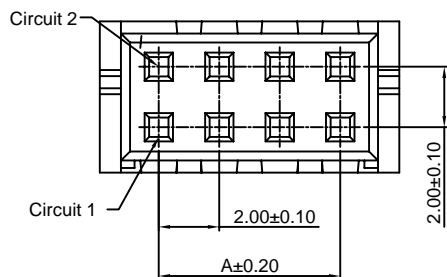

Ordering Information:

A2006H-2xXP - *** - **
1 2 3

1.Part No.

2.Material:

(Blank):Nylon 66,UL94V-0

GWT:Nylon 66,UL94V-0,GWT 750 °C

3.Color:

(Blank):White

BK:Black

RD:Red

YL:Yellow

BL:Blue

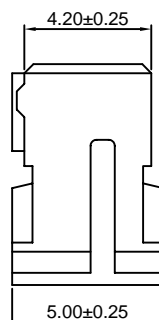
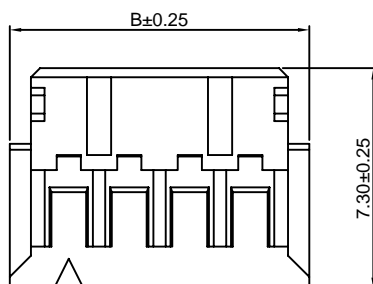

PART NO.	Dimensions	
	A	B
2x2P	2.00	5.90
2x3P	4.00	7.90
2x4P	6.00	9.90
2x5P	8.00	11.90
2x6P	10.00	13.90
2x7P	12.00	15.90
2x8P	14.00	17.90
2x9P	16.00	19.90
2x10P	18.00	21.90
2x11P	20.00	23.90
2x12P	22.00	25.90
2x13P	24.00	27.90
2x14P	26.00	29.90
2x15P	28.00	31.90
2x16P	30.00	33.90
2x17P	32.00	35.90
2x18P	34.00	37.90
2x19P	36.00	39.90
2x20P	38.00	41.90
2x21P	40.00	43.90
2x22P	42.00	45.90
2x23P	44.00	47.90
2x24P	46.00	49.90
2x25P	48.00	51.90

Unit: mm

A2006HA-2xXP

2.00mm pitch Dual Row Housing

Reference Informations:

- *Material:Nylon 66,UL94V-0
- *Suitable CJT A2006-T series Terminal
- *Mates with CJT A2006WVA,WRA-2xXP series Dual Row Wafer
- *Color:White

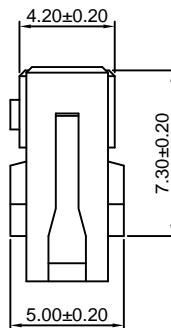
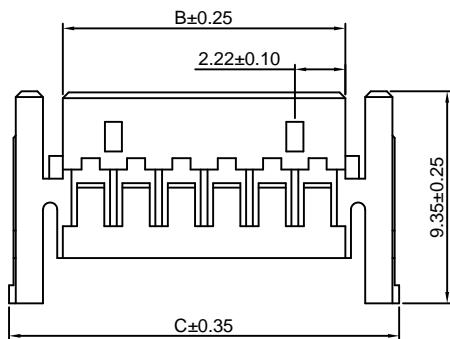
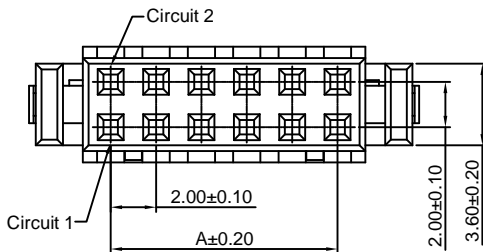

Ordering Information:

A2006HA-2xXP - *** - **
1 2 3

- Part No.
- Material:
(Blank):Nylon 66,UL94V-0
GWT:Nylon 66,UL94V-0,GWT 750 °C
- Color:
(Blank):White
BK:Black
RD:Red
YL:Yellow
BL:Blue

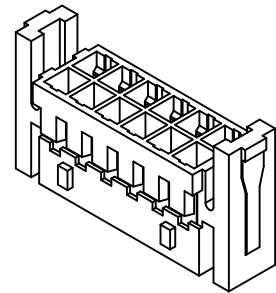

Ordering Information & Dimensions:

PART NO.	Dimensions		
	A	B	C
2x3P	4.00	6.45	11.60
2x4P	6.00	8.45	13.60
2x5P	8.00	10.45	15.60
2x6P	10.00	12.45	17.60
2x7P	12.00	14.45	19.60
2x8P	14.00	16.45	21.60
2x9P	16.00	18.45	23.60
2x10P	18.00	20.45	25.60
2x11P	20.00	22.45	27.60
2x12P	22.00	24.45	29.60
2x13P	24.00	26.45	31.60
2x14P	26.00	28.45	33.60
2x15P	28.00	30.45	35.60
2x16P	30.00	32.45	37.60
2x17P	32.00	34.45	39.60
2x18P	34.00	36.45	41.60
2x19P	36.00	38.45	43.60
2x20P	38.00	40.45	45.60

Unit: mm

A2006HB-2xXP

2.00mm pitch Dual Row Housing

Reference Informations:

- *Material:Nylon 66,UL94V-0
- *Suitable CJT A2006-T-B series Terminal
- *Mates with CJT A2006WVB ,WRB-2xXP series Dual Row Wafer
- *Color:White

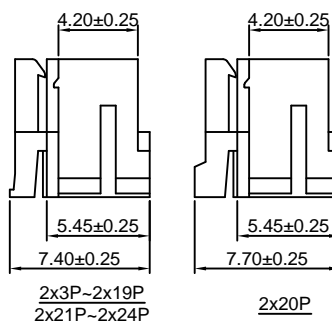
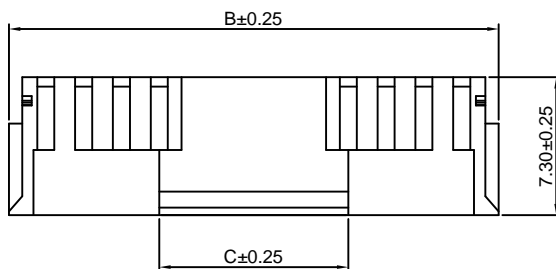
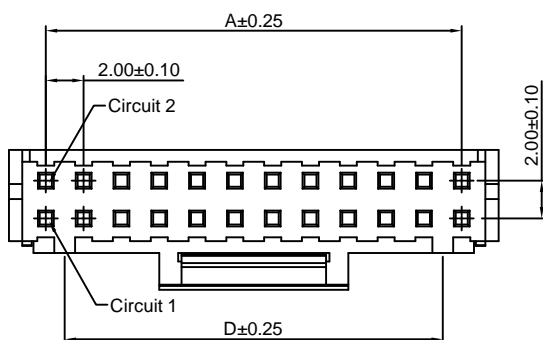

Ordering Information:

A2006HB-2xXP - *** - **
1 2 3

- Part No.
- Material:
(Blank):Nylon 66,UL94V-0
GWT:Nylon 66,UL94V-0,GWT 750 °C
- Color:
(Blank):White
BK:Black
RD:Red
YL:Yellow
BL:Blue

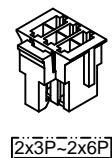
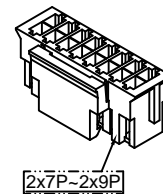
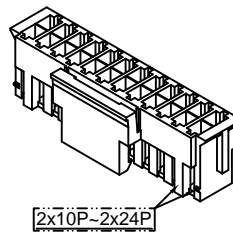

Ordering Information & Dimensions:

PART NO.	Dimensions			
	A	B	C	D
2x3P	4.00	7.90	5.25	----
2x4P	6.00	9.90	7.35	----
2x5P	8.00	11.90	9.35	----
2x6P	10.00	13.90	10.00	----
2x7P	12.00	15.90	10.00	12.00
2x8P	14.00	17.90	10.00	14.00
2x9P	16.00	19.90	10.00	16.00
2x10P	18.00	21.90	10.00	18.00
2x11P	20.00	23.90	10.00	20.00
2x12P	22.00	25.90	10.00	22.00
2x13P	24.00	27.90	10.00	24.00
2x14P	26.00	29.90	10.00	26.00
2x15P	28.00	31.90	10.00	28.00
2x16P	30.00	33.90	10.00	30.00
2x17P	32.00	35.90	10.00	32.00
2x18P	34.00	37.90	10.00	34.00
2x19P	36.00	39.90	10.00	36.00
2x20P	38.00	41.90	15.00	38.00
2x21P	40.00	43.90	10.00	40.00
2x22P	42.00	45.90	10.00	42.00
2x23P	44.00	47.90	10.00	44.00
2x24P	46.00	49.90	10.00	46.00

Unit: mm

A2006HU-2xXP

2.00mm pitch Dual Row Housing

Reference Informations:

- *Material:Nylon 66,UL94V-0
- *Suitable CJT A2006-T-U series Terminal
- *Mates with CJT A2006WVU,WRU-2xXP series Dual Row Wafer
- *Color:Natural

Ordering Information:

A2006HU-2xXP - *** - **
 1 2 3

- 1.Part No.
- 2.Material:
 (Blank):Nylon 66,UL94V-0
 GWT:Nylon 66,UL94V-0,GWT 750 °C
- 3.Color:
 (Blank):Natural
 BK:Black
 RD:Red
 YL:Yellow
 BL:Blue

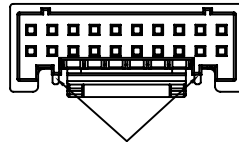
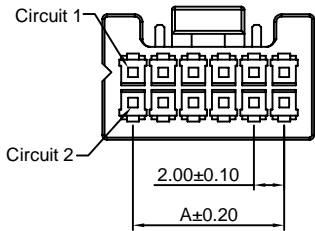
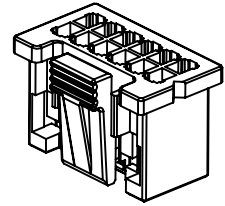

2x4P~2x7P Without Guide bulge
 2x8P~2x20P With Guide bulge

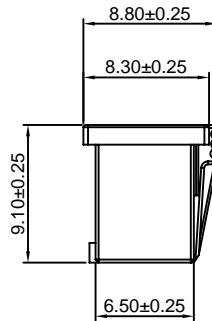
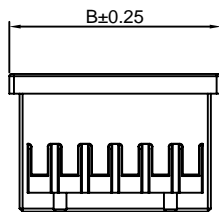

Ordering Information & Dimensions:

PART NO.	Dimensions	
	A	B
2x4P	6.00	10.00
2x5P	8.00	12.00
2x6P	10.00	14.00
2x7P	12.00	16.00
2x8P	14.00	18.00
2x9P	16.00	20.00
2x10P	18.00	22.00
2x11P	20.00	24.00
2x12P	22.00	26.00
2x13P	24.00	28.00
2x14P	26.00	30.00
2x15P	28.00	32.00
2x16P	30.00	34.00
2x17P	32.00	36.00
2x18P	34.00	38.00
2x19P	36.00	40.00
2x20P	38.00	42.00

Unit: mm

A2006WV-2xXP

2.00mm pitch 180° Dual Row Wafer

Reference Informations:

- *Material:Pin:Brass/Tin over Nickel
 Insulator:Nylon 66,UL94V-0
- *Mates with CJT A2006H-2xXP,A2009H-2xXP series Dual Row Housing
- *Color:Ivory

Ordering Information:

A2006WV-2xXP - *** - ** - **
 1 2 3 4

- 1.Part No.
- 2.Material:
 (Blank):Nylon 66,UL94V-0
 GWT:Nylon 66,UL94V-0,GWT 750 °C
- 3.Color:
 (Blank):Ivory
 BK:Black
 RD:Red
 YL:Yellow
 BL:Blue
- 4.Finish:
 (Blank):Tin over Nickel
 G:Gold over Nickel

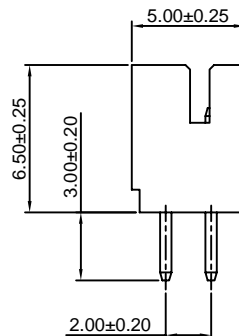
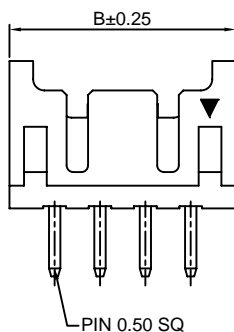
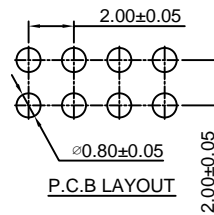
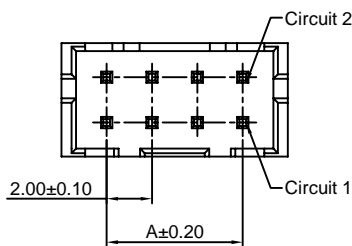

Ordering Information & Dimensions:

PART NO.	Dimensions	
	A	B
2x2P	2.00	5.90
2x3P	4.00	7.90
2x4P	6.00	9.90
2x5P	8.00	11.90
2x6P	10.00	13.90
2x7P	12.00	15.90
2x8P	14.00	17.90
2x9P	16.00	19.90
2x10P	18.00	21.90
2x11P	20.00	23.90
2x12P	22.00	25.90
2x13P	24.00	27.90
2x14P	26.00	29.90
2x15P	28.00	31.90
2x16P	30.00	33.90
2x17P	32.00	35.90
2x18P	34.00	37.90
2x19P	36.00	39.90
2x20P	38.00	41.90
2x21P	40.00	43.90
2x22P	42.00	45.90
2x23P	44.00	47.90
2x24P	46.00	49.90
2x25P	48.00	51.90

Unit: mm

A2006WR-2xXP

2.00mm pitch 90° Dual Row Wafer

Reference Informations:

- *Material: Pin: Brass/Tin over Nickel
Insulator: Nylon 66, UL94V-0
- *Mates with CJT A2006H-2xXP, A2009H-2xXP series Dual Row Housing
- *Color: Ivory

Ordering Information:

A2006WR-2xXP - ^{***}/₁ - ^{**}/₂ - ^{**}/₃ - ^{**}/₄

- Part No.
- Material:
(Blank): Nylon 66, UL94V-0
GWT: Nylon 66, UL94V-0, GWT 750 °C
- Color:
(Blank): Ivory
BK: Black
RD: Red
YL: Yellow
BL: Blue
- Finish:
(Blank): Tin over Nickel
G: Gold over Nickel

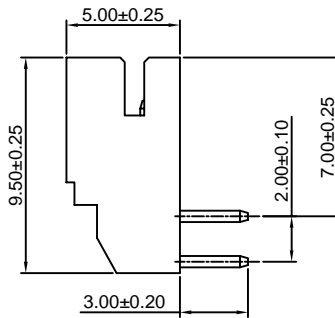
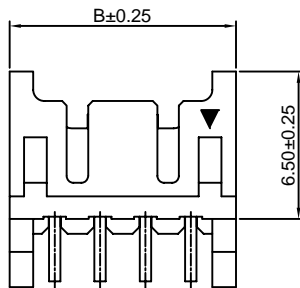
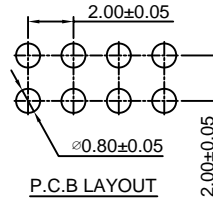
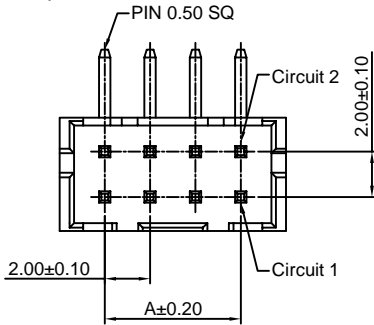

Ordering Information & Dimensions:

PART NO.	Dimensions	
	A	B
2x2P	2.00	5.90
2x3P	4.00	7.90
2x4P	6.00	9.90
2x5P	8.00	11.90
2x6P	10.00	13.90
2x7P	12.00	15.90
2x8P	14.00	17.90
2x9P	16.00	19.90
2x10P	18.00	21.90
2x11P	20.00	23.90
2x12P	22.00	25.90
2x13P	24.00	27.90
2x14P	26.00	29.90
2x15P	28.00	31.90
2x16P	30.00	33.90
2x17P	32.00	35.90
2x18P	34.00	37.90
2x19P	36.00	39.90
2x20P	38.00	41.90
2x21P	40.00	43.90
2x22P	42.00	45.90
2x23P	44.00	47.90
2x24P	46.00	49.90
2x25P	48.00	51.90

Unit: mm

A2006WVA-2xXP

2.00mm pitch 180° Dual Row Wafer

Reference Informations:

- *Material: Pin: Brass/Tin over Nickel
Insulator: Nylon 66, UL94V-0
- *Mates with CJT A2006HA-2xXP series Dual Row Housing
- *Color: Ivory

Ordering Information:

A2006WVA-2xXP - ^{***}/₁ - ^{**}/₂ - ^{**}/₃ - ^{**}/₄

- Part No.
- Material:
(Blank): Nylon 66, UL94V-0
GWT: Nylon 66, UL94V-0, GWT 750 °C
- Color:
(Blank): Ivory
BK: Black
RD: Red
YL: Yellow
BL: Blue
- Finish:
(Blank): Tin over Nickel
G: Gold over Nickel

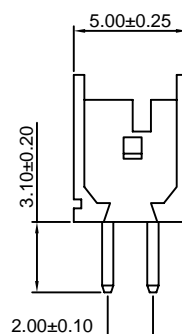
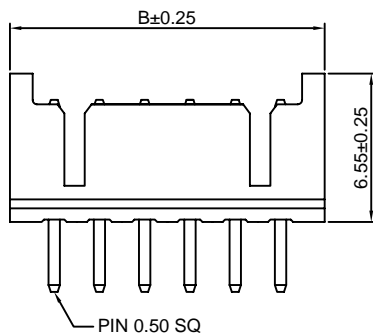
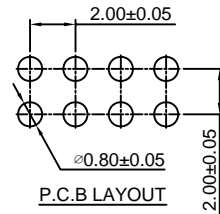
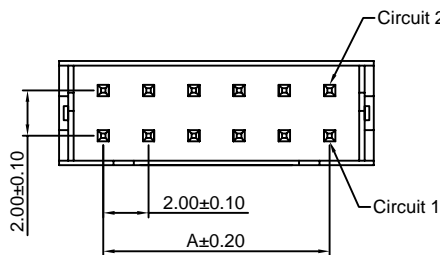

Ordering Information & Dimensions:

PART NO.	Dimensions	
	A	B
2x2P	2.00	8.00
2x3P	4.00	10.00
2x4P	6.00	12.00
2x5P	8.00	14.00
2x6P	10.00	16.00
2x7P	12.00	18.00
2x8P	14.00	20.00
2x9P	16.00	22.00
2x10P	18.00	24.00
2x11P	20.00	26.00
2x12P	22.00	28.00
2x13P	24.00	30.00
2x14P	26.00	32.00
2x15P	28.00	34.00
2x16P	30.00	36.00
2x17P	32.00	38.00
2x18P	34.00	40.00
2x19P	36.00	42.00
2x20P	38.00	44.00

Unit: mm

A2006WRA-2xXP

2.00mm pitch 90° Dual Row Wafer

Reference Informations:

- *Material: Pin: Brass/Tin over Nickel
Insulator: Nylon 66, UL94V-0
- *Mates with CJT A2006HA-2xXP series Dual Row Housing
- *Color: Ivory

Ordering Information:

A2006WRA-2xXP - *** - ** - **
1 2 3 4

- Part No.
- Material:
(Blank): Nylon 66, UL94V-0
GWT: Nylon 66, UL94V-0, GWT 750°C
- Color:
(Blank): Ivory
BK: Black
RD: Red
YL: Yellow
BL: Blue
- Finish:
(Blank): Tin over Nickel
G: Gold over Nickel

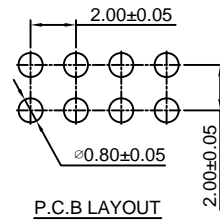

P.C.B LAYOUT

Ordering Information & Dimensions:

PART NO.	Dimensions	
	A	B
2x2P	2.00	8.00
2x3P	4.00	10.00
2x4P	6.00	12.00
2x5P	8.00	14.00
2x6P	10.00	16.00
2x7P	12.00	18.00
2x8P	14.00	20.00
2x9P	16.00	22.00
2x10P	18.00	24.00
2x11P	20.00	26.00
2x12P	22.00	28.00
2x13P	24.00	30.00
2x14P	26.00	32.00
2x15P	28.00	34.00
2x16P	30.00	36.00
2x17P	32.00	38.00
2x18P	34.00	40.00
2x19P	36.00	42.00
2x20P	38.00	44.00

Unit: mm

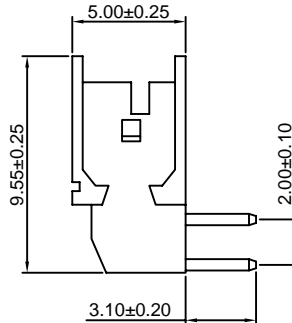
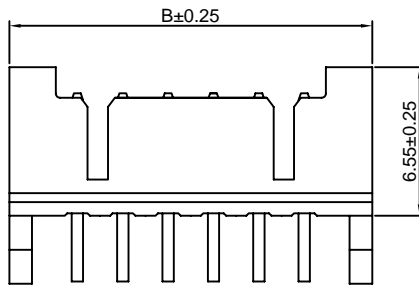
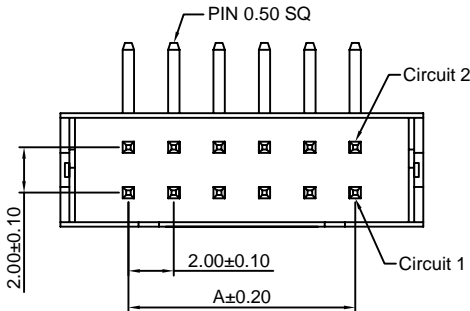

A2006WV-S-2xXP

2.00mm pitch 180° Dual Row Wafer - SMT TYPE

Reference Informations:

- *Material: Pin: Brass/Tin over Nickel
Insulator: Nylon 6T, UL94V-0
- *Mates with CJT A2006H-2xXP, A2009H-2xXP series Dual Row Housing
- *Color: Ivory

Ordering Information:

A2006WV-S-2xXP - *** - ** - **
1 2 3 4

- Part No.
- Material:
(Blank): Nylon 6T, UL94V-0
GWT: Nylon 6T, UL94V-0, GWT 750°C
- Color:
(Blank): Ivory
BK: Black
RD: Red
YL: Yellow
BL: Blue
- Finish:
(Blank): Tin over Nickel
G: Gold over Nickel

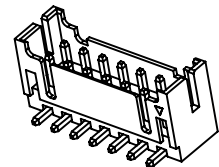

Ordering Information & Dimensions:

PART NO.	Dimensions	
	A	B
2x2P	2.00	6.00
2x3P	4.00	8.00
2x4P	6.00	10.00
2x5P	8.00	12.00
2x6P	10.00	14.00
2x7P	12.00	16.00
2x8P	14.00	18.00
2x9P	16.00	20.00
2x10P	18.00	22.00
2x11P	20.00	24.00
2x12P	22.00	26.00
2x13P	24.00	28.00
2x14P	26.00	30.00
2x15P	28.00	32.00
2x16P	30.00	34.00
2x17P	32.00	36.00
2x18P	34.00	38.00
2x19P	36.00	40.00
2x20P	38.00	42.00
2x21P	40.00	44.00
2x22P	42.00	46.00
2x23P	44.00	48.00
2x24P	46.00	50.00
2x25P	48.00	52.00

Unit: mm

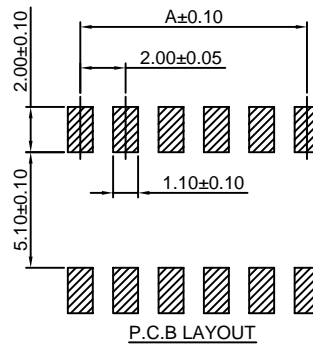
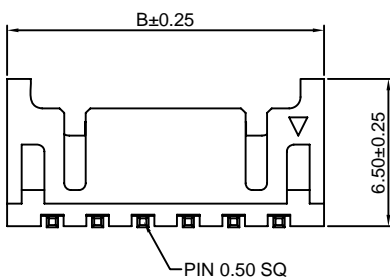
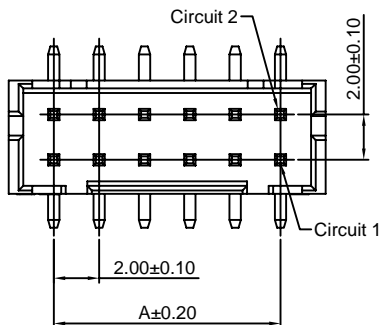

P.C.B LAYOUT

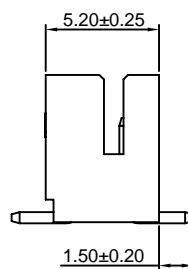

A2006WV-S-F-2xXP

2.00mm pitch 180° Dual Row Wafer - SMT TYPE

Reference Informations:

- *Material: Pin: Brass/Tin over Nickel
Insulator: Nylon 6T, UL94V-0
- *Mates with CJT A2006H-2xXP, A2009H-2xXP series Dual Row Housing
- *Color: Ivory

Ordering Information:

A2006WV-S-F-2xXP - $\frac{***}{1} - \frac{**}{2} - \frac{**}{3} - \frac{**}{4}$

- Part No.
- Material:
(Blank): Nylon 6T, UL94V-0
GWT: Nylon 6T, UL94V-0, GWT 750 °C
- Color:
(Blank): Ivory
BK: Black
RD: Red
YL: Yellow
BL: Blue
- Finish:
(Blank): Tin over Nickel
G: Gold over Nickel

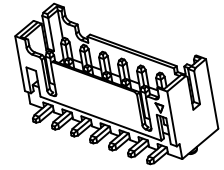

Ordering Information & Dimensions:

PART NO.	Dimensions		
	A	B	C
2x2P	2.00	6.00	4.00
2x3P	4.00	8.00	6.00
2x4P	6.00	10.00	8.00
2x5P	8.00	12.00	10.00
2x6P	10.00	14.00	12.00
2x7P	12.00	16.00	14.00
2x8P	14.00	18.00	16.00
2x9P	16.00	20.00	18.00
2x10P	18.00	22.00	20.00
2x11P	20.00	24.00	22.00
2x12P	22.00	26.00	24.00
2x13P	24.00	28.00	26.00
2x14P	26.00	30.00	28.00
2x15P	28.00	32.00	30.00
2x16P	30.00	34.00	32.00
2x17P	32.00	36.00	34.00
2x18P	34.00	38.00	36.00
2x19P	36.00	40.00	38.00
2x20P	38.00	42.00	40.00
2x21P	40.00	44.00	42.00
2x22P	42.00	46.00	44.00
2x23P	44.00	48.00	46.00
2x24P	46.00	50.00	48.00
2x25P	48.00	52.00	50.00

Unit: mm

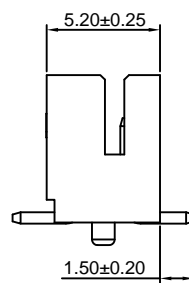
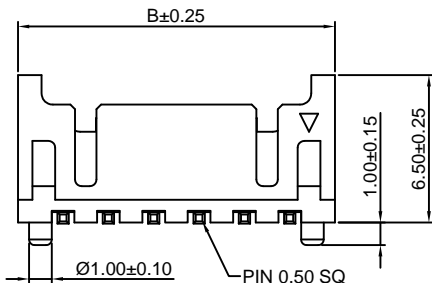
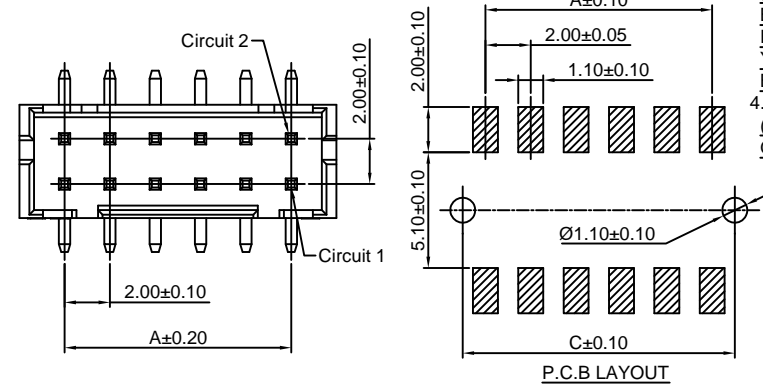

A2006WVB-2xXP

2.00mm pitch 180° Dual Row Wafer

Reference Informations:

- *Material: Pin: Brass/Tin over Nickel
Insulator: Nylon 66, UL94V-0
- *Mates with CJT A2006HB-2xXP series Dual Row Housing
- *Color: White

Ordering Information:

A2006WVB-2xXP - $\frac{***}{1} - \frac{**}{2} - \frac{**}{3} - \frac{**}{4}$

- Part No.
- Material:
(Blank): Nylon 66, UL94V-0
GWT: Nylon 66, UL94V-0, GWT 750 °C
- Color:
(Blank): White
BK: Black
RD: Red
YL: Yellow
BL: Blue
- Finish:
(Blank): Tin over Nickel
G: Gold over Nickel

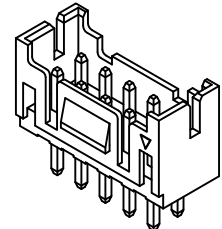

Ordering Information & Dimensions:

PART NO.	Dimensions	
	A	B
2x2P	2.00	6.00
2x3P	4.00	8.00
2x4P	6.00	10.00
2x5P	8.00	12.00
2x6P	10.00	14.00
2x7P	12.00	16.00
2x8P	14.00	18.00
2x9P	16.00	20.00
2x10P	18.00	22.00
2x11P	20.00	24.00
2x12P	22.00	26.00
2x13P	24.00	28.00
2x14P	26.00	30.00
2x15P	28.00	32.00
2x16P	30.00	34.00
2x17P	32.00	36.00
2x18P	34.00	38.00
2x19P	36.00	40.00
2x20P	38.00	42.00

Unit: mm

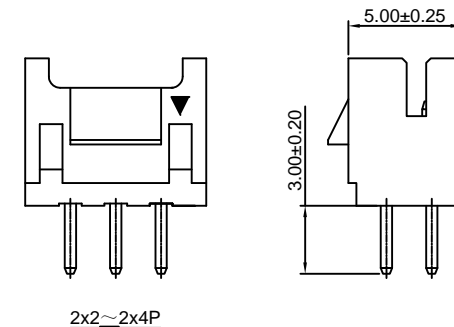
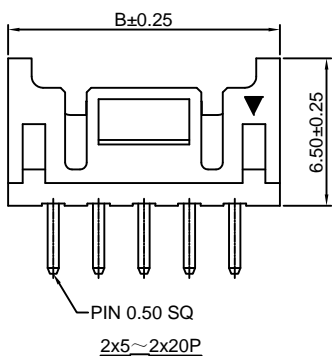
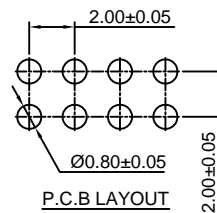
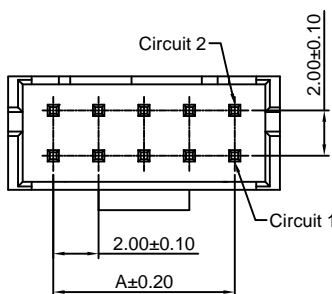

A2006WRB-2xXP

2.00mm pitch 90° Dual Row Wafer

Reference Informations:

- *Material: Pin: Brass/Tin over Nickel
Insulator: Nylon 66, UL94V-0
- *Mates with CJT A2006HB-2xXP series Dual Row Housing
- *Color: White

Ordering Information:

A2006WRB-2xXP - *** - ** - **
1 2 3 4

- Part No.
- Material:
(Blank): Nylon 66, UL94V-0
GWT: Nylon 66, UL94V-0, GWT 750 °C
- Color:
(Blank): White
BK: Black
RD: Red
YL: Yellow
BL: Blue
- Finish:
(Blank): Tin over Nickel
G: Gold over Nickel

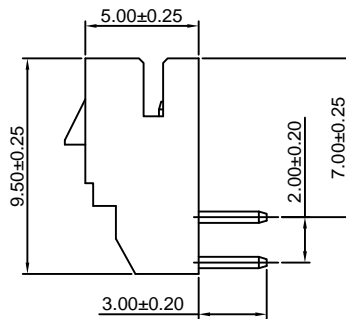
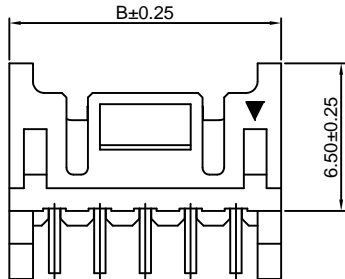
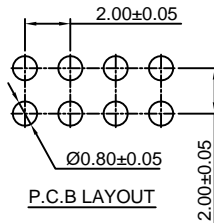
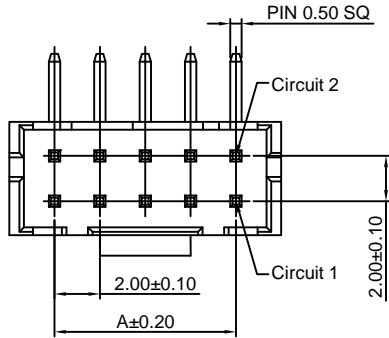
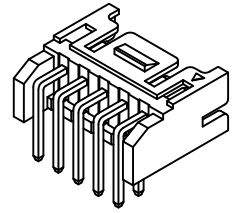

Ordering Information & Dimensions:

PART NO.	Dimensions	
	A	B
2x2P	2.00	6.00
2x3P	4.00	8.00
2x4P	6.00	10.00
2x5P	8.00	12.00
2x6P	10.00	14.00
2x7P	12.00	16.00
2x8P	14.00	18.00
2x9P	16.00	20.00
2x10P	18.00	22.00
2x11P	20.00	24.00
2x12P	22.00	26.00
2x13P	24.00	28.00
2x14P	26.00	30.00
2x15P	28.00	32.00
2x16P	30.00	34.00
2x17P	32.00	36.00
2x18P	34.00	38.00
2x19P	36.00	40.00
2x20P	38.00	42.00

Unit: mm

A2006WVU-2xXP

2.00mm pitch 180° Dual Row Wafer

Reference Informations:

- *Material: Pin: Brass/Tin over Nickel
Insulator: PA4T, UL94V-0
- *Mates with CJT A2006HU-2xXP series Dual Row Housing
- *Color: Natural

Ordering Information:

A2006WVU-2xXP - *** - ** - **
1 2 3 4

- Part No.
- Material:
(blank): PA4T, UL94V-0
GWT: PA4T, UL94V-0, GWT 750 °C
- Color:
(Blank): Natural
BK: Black
RD: Red
YL: Yellow
BL: Blue
- Finish:
(Blank): Tin over Nickel
G: Gold over Nickel

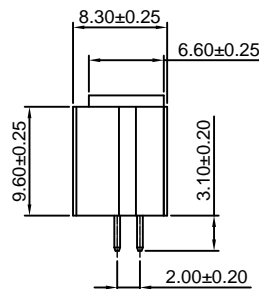
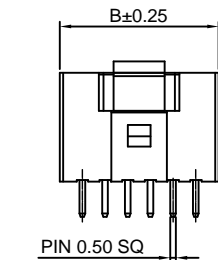
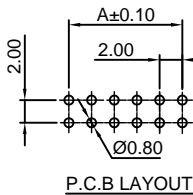
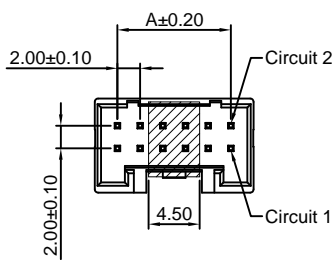
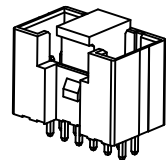

Ordering Information & Dimensions:

PART NO.	Dimensions	
	A	B
2x4P	6.00	10.00
2x5P	8.00	12.00
2x6P	10.00	14.00
2x7P	12.00	16.00
2x8P	14.00	18.00
2x9P	16.00	20.00
2x10P	18.00	22.00
2x11P	20.00	24.00
2x12P	22.00	26.00
2x13P	24.00	28.00
2x14P	26.00	30.00
2x15P	28.00	32.00
2x16P	30.00	34.00
2x17P	32.00	36.00
2x18P	34.00	38.00
2x19P	36.00	40.00
2x20P	38.00	42.00

Unit: mm

2x4P~2x7P Without Guideway
2x8P~2x20P With Guideway

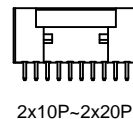
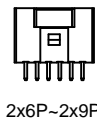
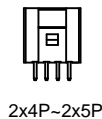

A2009H-2xXP

2.00mm pitch Dual Row Housing

Reference Informations:

- *Material:Nylon 66,UL94V-0
- *Suitable CJT A2008-T series Terminal
- *Mates with CJT A2006WV,WR,WV-S,WV-S-F-2xXP series Dual Row Wafer
- *Color:Black

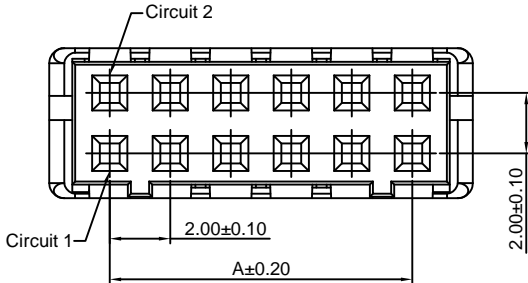
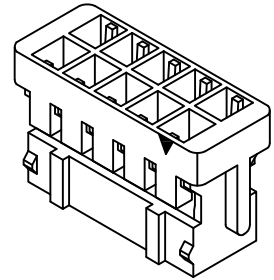

Ordering Information:
A2009H-2xXP - *** - ***
1 2 3

- 1.Part No.
- 2.Material:
(Blank):Nylon 66,UL94V-0
GWT:Nylon 66,UL94V-0,GWT 750°C
- 3.Color:
(Blank):Black
GY:Gray
WH:White

Ordering Information & Dimensions:

PART NO.	Dimensions	
	A	B
2x2P	2.00	6.00
2x3P	4.00	8.00
2x4P	6.00	10.00
2x5P	8.00	12.00
2x6P	10.00	14.00
2x7P	12.00	16.00
2x8P	14.00	18.00
2x9P	16.00	20.00
2x10P	18.00	22.00
2x11P	20.00	24.00
2x12P	22.00	26.00
2x13P	24.00	28.00
2x14P	26.00	30.00
2x15P	28.00	32.00
2x16P	30.00	34.00
2x17P	32.00	36.00
2x18P	34.00	38.00
2x19P	36.00	40.00
2x20P	38.00	42.00

Unit: mm

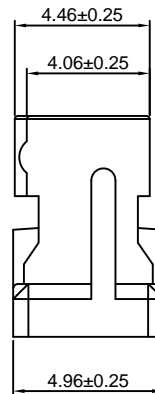
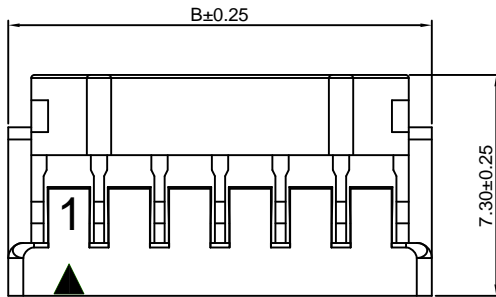

A2009WV-S-2xXP

2.00mm pitch 180° Dual Row Wafer-SMT TYPE

Reference Informations:

- *Material:Pin:Brass/Tin over Nickel
Insulator:Nylon 9T,UL94V-0
Cap:Nylon 46,UL94V-0(Black)
- *Mates with CJT A2009H-2xXP series Dual Row Wafer
- *Color:Beige

Ordering Information:
A2009WV-S-2xXP - *** - **
1 2 3

- 1.Part No.
- 2.Material:
(Blank):Nylon 9T,UL94V-0
GWT:Nylon 9T,UL94V-0,GWT 750°C
- 3.Finish:
(Blank):Tin over Nickel
G:Gold over Nickel

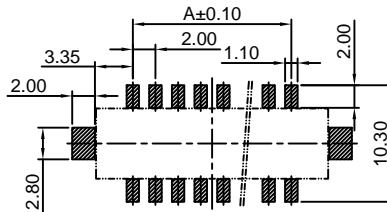

P.C.B LAYOUT

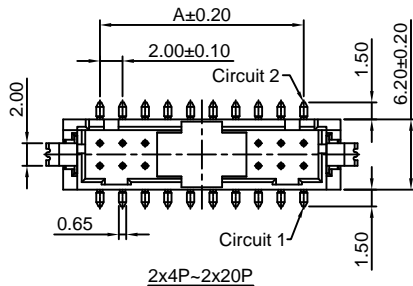

2x4P~2x20P

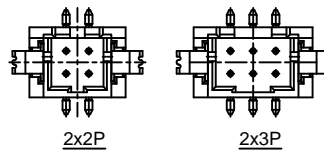

2x2P

2x3P

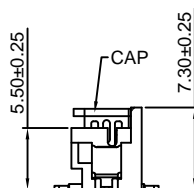
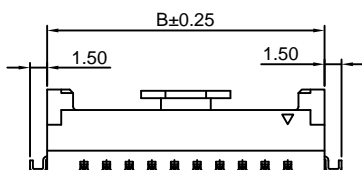

CAP

Ordering Information & Dimensions:

PART NO.	Dimensions	
	A	B
2x2P	2.00	8.50
2x3P	4.00	10.50
2x4P	6.00	12.50
2x5P	8.00	14.50
2x6P	10.00	16.50
2x7P	12.00	18.50
2x8P	14.00	20.50
2x9P	16.00	22.50
2x10P	18.00	24.50
2x11P	20.00	26.50
2x12P	22.00	28.50
2x13P	24.00	30.50
2x14P	26.00	32.50
2x15P	28.00	34.50
2x16P	30.00	36.50
2x17P	32.00	38.50
2x18P	34.00	40.50
2x19P	36.00	42.50
2x20P	38.00	44.50

Unit: mm

单击下面可查看定价，库存，交付和生命周期等信息

[>>CJTconn](#)