

Zener diode

Features

1. Small surface mounting type
2. High reliability



Applications

Voltage stabilization

Absolute Maximum Ratings

$T_j=25^{\circ}\text{C}$

Parameter	Test Conditions	Type	Symbol	Value	Unit
Power dissipation	$R_{thJA} \leq 300\text{K/W}$		P_v	500	mW
Z-current			I_z	P_v / V_z	mA
Junction temperature			T_j	175	$^{\circ}\text{C}$
Storage temperature range			T_{stg}	-65~+175	$^{\circ}\text{C}$

Maximum Thermal Resistance

$T_j=25^{\circ}\text{C}$

Parameter	Test Conditions	Symbol	Value	Unit
Junction ambient	on PC board 50mm×50mm×1.6mm	R_{thJA}	500	K/W

Stresses exceeding maximum ratings may damage the device. Maximum ratings are stress ratings only. Functional operation above the recommended operating conditions is not implied. Extended exposure to stresses above the recommended operating conditions may affect device reliability.

Electrical Characteristics

$T_j=25^{\circ}\text{C}$

Parameter	Test Conditions	Type	Symbol	Min	Typ	Max	Unit
Forward voltage	$I_F=200\text{mA}$		V_F			1.5	V

Type	V _{Znom}	I _{ZT}	for V _Z and	r _{ZT}	r _{ZK} at I _{ZK}	I _R and I _R at V _R	TK _{vz}
LL55C.	V	mA	V	Ω	Ω	μA and μA ₁₎	%/K
2V0	2.0	5	1.9~2.1	100	<600	1 <150 <300	1 -0.09~-0.06
2V2	2.2	5	2.09~2.31	100	<600	1 <150 <300	1 -0.09~-0.06
2V4	2.4	5	2.28~2.56	<85	<600	1 <50 <100	1 -0.09~-0.06
2V7	2.7	5	2.5~2.9	<85	<600	1 <10 <50	1 -0.09~-0.06
3V0	3.0	5	2.8~3.2	<85	<600	1 <4 <40	1 -0.08~-0.05
3V3	3.3	5	3.1~3.5	<85	<600	1 <2 <40	1 -0.08~-0.05
3V6	3.6	5	3.4~3.8	<85	<600	1 <2 <40	1 -0.08~-0.05
3V9	3.9	5	3.7~4.1	<85	<600	1 <2 <40	1 -0.08~-0.05
4V3	4.3	5	4.0~4.6	<75	<600	1 <1 <20	1 -0.06~-0.03
4V7	4.7	5	4.4~5.0	<60	<600	1 <0.5 <10	1 -0.05~+0.02
5V1	5.1	5	4.8~5.4	<35	<550	1 <0.1 <2	1 -0.02~+0.02
5V6	5.6	5	5.2~6.0	<25	<450	1 <0.1 <2	1 -0.05~+0.05
6V2	6.2	5	5.8~6.6	<10	<200	1 <0.1 <2	2 0.03~0.06
6V8	6.8	5	6.4~7.2	<8	<150	1 <0.1 <2	3 0.03~0.07
7V5	7.5	5	7.0~7.9	<7	<50	1 <0.1 <2	5 0.03~0.07
8V2	8.2	5	7.7~8.7	<7	<50	1 <0.1 <2	6.2 0.03~0.08
9V1	9.1	5	8.5~9.6	<10	<50	1 <0.1 <2	6.8 0.03~0.09
10	10	5	9.4~10.6	<15	<70	1 <0.1 <2	7.5 0.03~0.1
11	11	5	10.4~11.6	<20	<70	1 <0.1 <2	8.2 0.03~0.11
12	12	5	11.4~12.7	<20	<90	1 <0.1 <2	9.1 0.03~0.11
13	13	5	12.4~14.1	<26	<110	1 <0.1 <2	10 0.03~0.11
15	15	5	13.8~15.6	<30	<110	1 <0.1 <2	11 0.03~0.11
16	16	5	15.3~17.1	<40	<170	1 <0.1 <2	12 0.03~0.11
18	18	5	16.8~19.1	<50	<170	1 <0.1 <2	13 0.03~0.11
20	20	5	18.8~21.2	<55	<220	1 <0.1 <2	15 0.03~0.11
22	22	5	20.8~23.3	<55	<220	1 <0.1 <2	16 0.04~0.12
24	24	5	22.8~25.6	<80	<220	1 <0.1 <2	18 0.04~0.12
27	27	5	25.1~28.9	<80	<220	1 <0.1 <2	20 0.04~0.12
30	30	5	28~32	<80	<220	1 <0.1 <2	22 0.04~0.12
33	33	5	31~35	<80	<220	1 <0.1 <2	24 0.04~0.12
36	36	5	34~38	<80	<220	1 <0.1 <2	27 0.04~0.12
39	39	2.5	37~41	<90	<500	0.5 <0.1 <5	30 0.04~0.12
43	43	2.5	40~46	<90	<600	0.5 <0.1 <5	33 0.04~0.12
47	47	2.5	44~50	<110	<700	0.5 <0.1 <5	36 0.04~0.12
51	51	2.5	48~54	<125	<700	0.5 <0.1 <10	39 0.04~0.12
56	56	2.5	52~60	<135	<1000	0.5 <0.1 <10	43 0.04~0.12
62	62	2.5	58~66	<150	<1000	0.5 <0.1 <10	47 0.04~0.12
68	68	2.5	64~72	<200	<1000	0.5 <0.1 <10	51 0.04~0.12
75	75	2.5	70~79	<250	<1500	0.5 <0.1 <10	56 0.04~0.12
82	82	2.5	77~87	<300	<2000	0.5 <0.1 <10	62 0.04~0.12
91	91	1.0	85~96	<450	<5000	0.1 <0.1 <10	68 0.04~0.12
100	100	1.0	94~106	<450	<5000	0.1 <0.1 <10	75 0.04~0.12

¹⁾ at T_j=150°C

Characteristics ($T_j=25^\circ\text{C}$ unless otherwise specified)

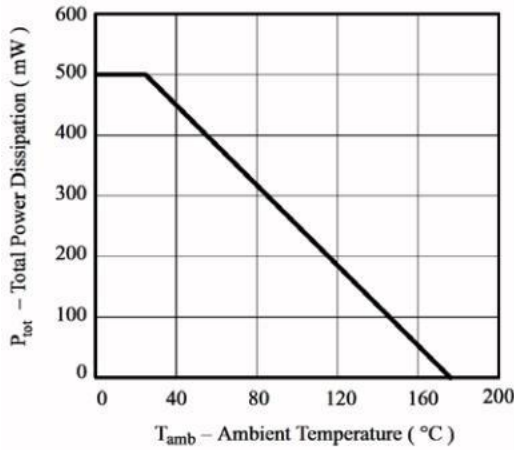

Figure 1. Total Power Dissipation vs. Ambient Temperature

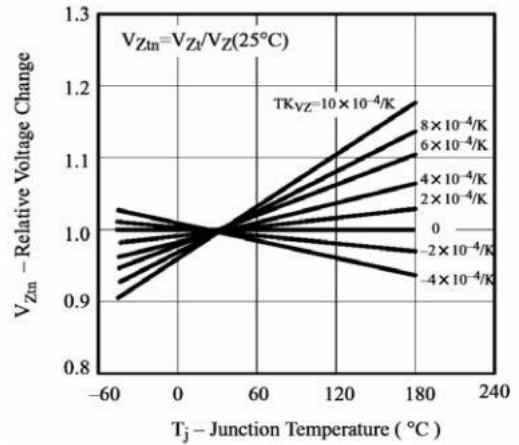

Figure 4. Typical Change of Working Voltage Vs. Junction Temperature

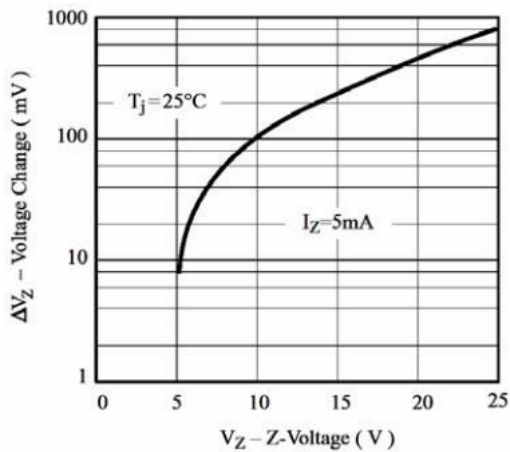

Figure 2. Typical Change of Working Voltage under Operating Conditions at $T_{amb}=25^\circ\text{C}$

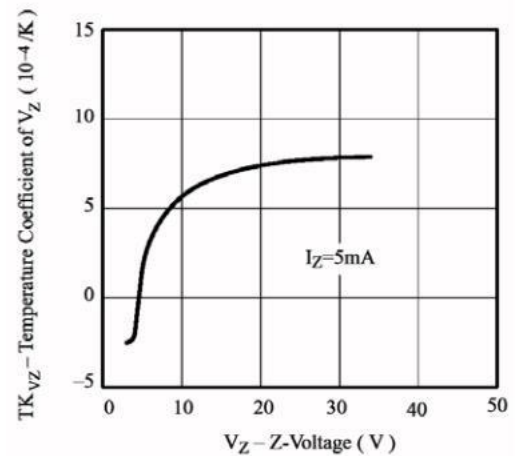

Figure 5. Temperature Coefficient of V_Z vs. Z-Voltage

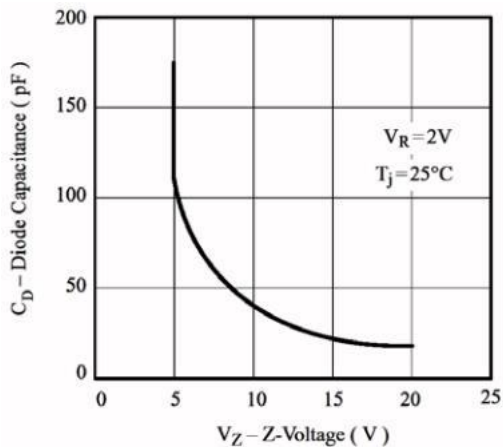

Figure 3. Diode Capacitance vs. Z-voltage

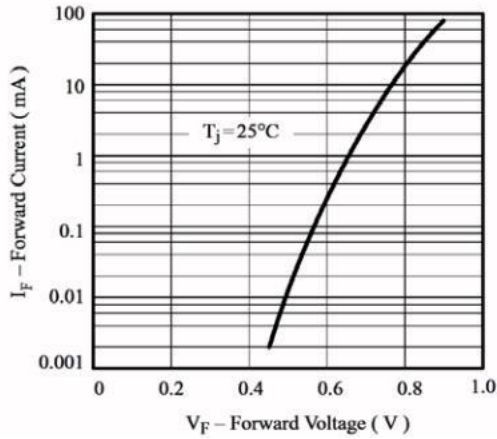

Figure 6. Forward Current vs. Forward Voltage

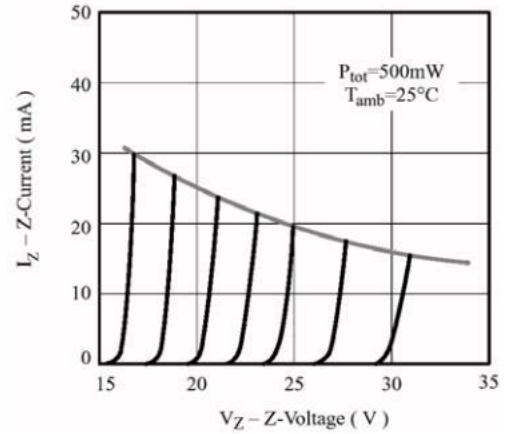

Figure 8. Z-Current vs. Z-Voltage

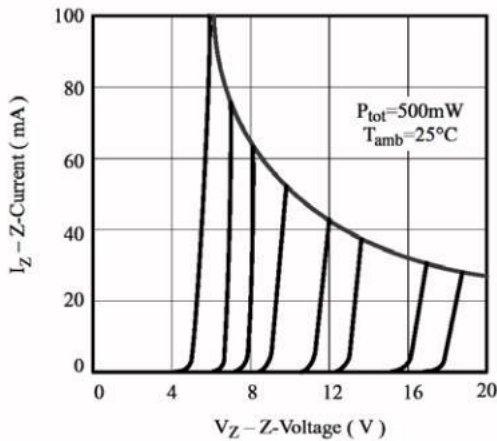

Figure 7. Z-Current vs. Z-Voltage

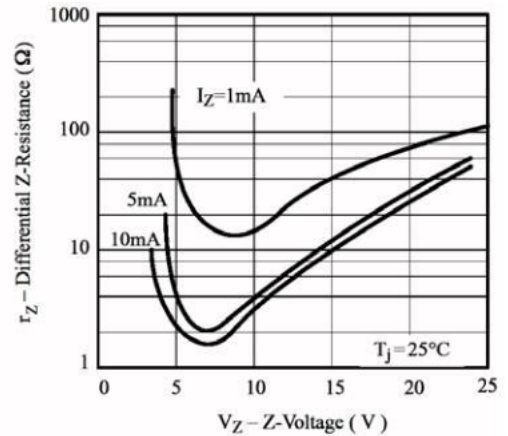

Figure 9. Differential Z-Resistance Vz vs. Z-Voltage

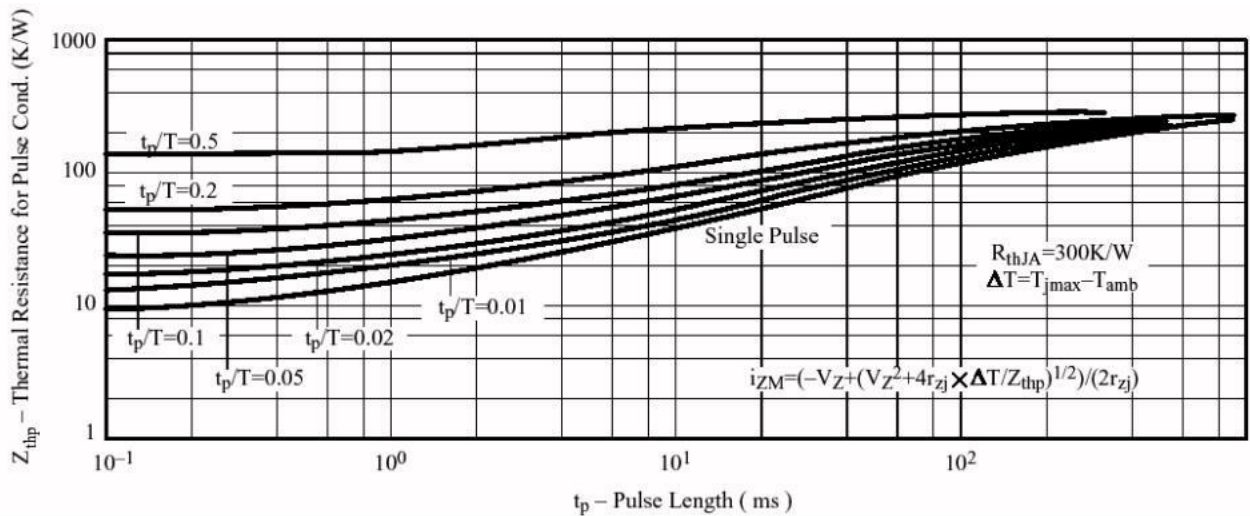
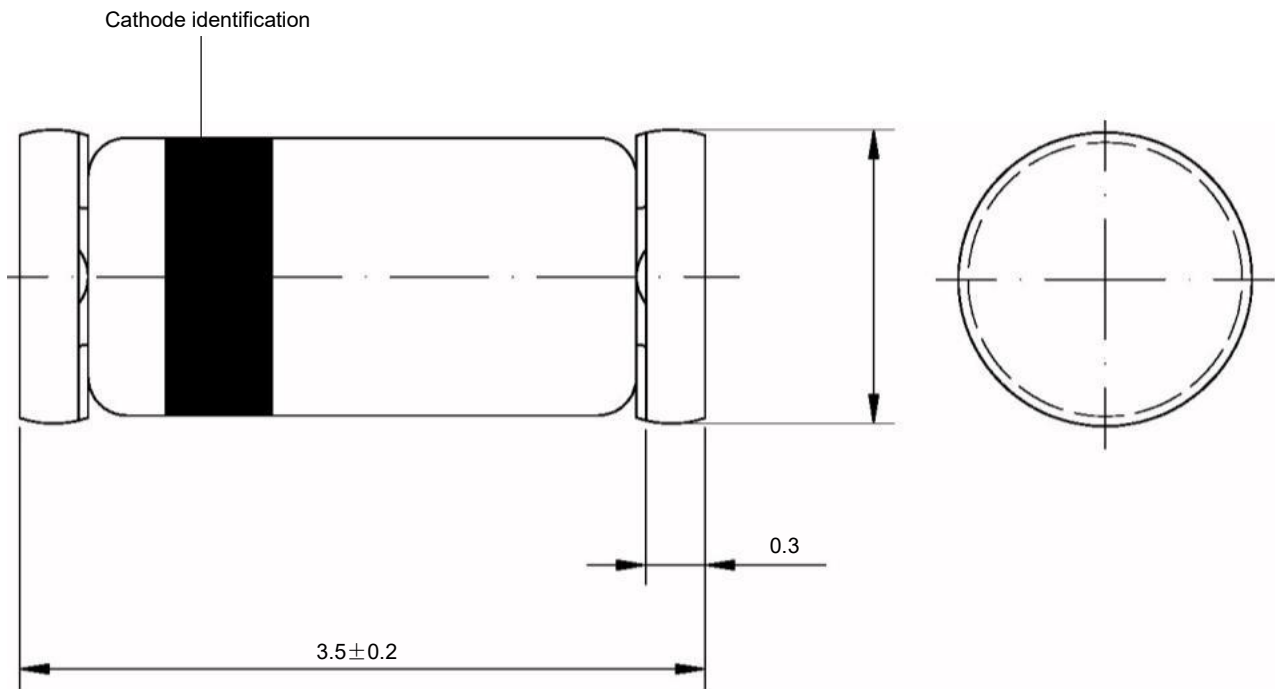

Figure 10. Thermal Response

Dimensions in mm



Glass Case
Mini Melf / SOD-80
JEDEC DO-213 AA

单击下面可查看定价，库存，交付和生命周期等信息

[>>COMON\(阔迈\)](#)