

## FEATURES

- Internally frequency compensated for unity gain
- Large DC voltage gain: 100dB
- Wide power supply range: 3V ~ 32V (or 1.5V ~ 16V)
- Input common-mode voltage range includes ground
- Large output voltage swing: 0V DC to  $V_{CC}-1.5V$  DC
- Power drain suitable for battery operation
- Low input offset voltage and offset current
- Differential input voltage range equal to the power supply voltage

## GENERAL DESCRIPTION

The CBM2904 contains two independent high gain operational amplifiers with internal frequency compensation. The two op-amps operate over a wide voltage range from a single power supply. Also use a split power supply. The device has low power supply current drain, regardless of the power supply voltage. The low power drain also makes the CBM2904 a good choice for battery operation.

When your project calls for a traditional op-amp function, now you can streamline your design with a simple single power supply. Use ordinary  $+5V_{DC}$  common to practically any digital system or personal computer application, without requiring an extra 15V power supply just to have the interface electronics you need.

The CBM2904 is a versatile, rugged workhorse with a thousand-and-one uses, from amplifying signals from a variety of transducers to dc gain blocks, or any op-amp function. The attached pages offer some recipes that will have your project cooking in no time.

### LOGIC DIAGRAM

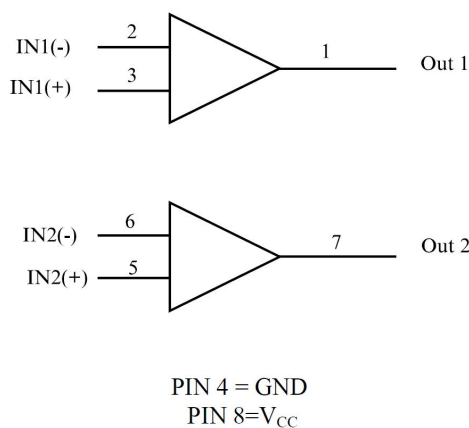

### PIN ASSIGNMENT

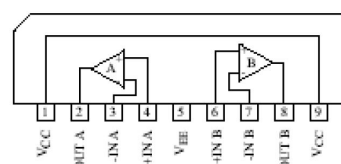
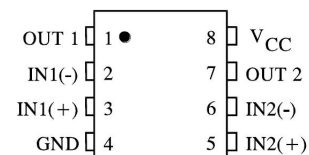

## MAXIMUM RATINGS\*

Symbol	Parameter	Value	Unit
$V_{CC}$	Power Supply Voltages		
	Single Supply	32	V
	Split Supplies	$\pm 16$	
$V_{IDR}$	Input Differential Voltage Range (1)	$\pm 32$	V
$V_{ICR}$	Input Common Mode Voltage Range	-0.3 to 32	V
$I_{SC}$	Output Short Circuit Duration	Continuous	
$T_J$	Junction Temperature		$^{\circ}C$
	Plastic Packages	150	
$T_{stg}$	Storage Temperature		$^{\circ}C$
	Plastic Packages	-55 to +125	
$I_{IN}$	Input Current, per pin (2)	50	mA
$T_L$	Lead Temperature, 1mm from Case for 10 Seconds	260	$^{\circ}C$

\* Stresses beyond those listed under "absolute maximum ratings" may cause permanent damage to the device.

These are stress ratings only and functional operation of the device at these or any other conditions beyond those indicated under "recommended operating conditions" is not implied. Exposure to absolute-maximum-rated conditions for extended periods may affect device reliability.

Functional operation should be restricted to the Recommended Operating Conditions.

+Derating - Plastic DIP: - 10 mW/ $^{\circ}C$  from 65 $^{\circ}C$  to 125 $^{\circ}C$

SOIC Package: - 7 mW/ $^{\circ}C$  from 65 $^{\circ}C$  to 125 $^{\circ}C$

Notes:

1. Split Power Supplies.
2.  $V_{IN} < -0.3V$ . This input current will only exist when voltage at any of the input leads is driven negative.

## Recommended Operating Conditions

Symbol	Parameter	Min	Max	Unit
$V_{CC}$	DC Supply Voltage	$\pm 2.5$ or 5.0	$\pm 15$ or 30	V
$T_A$	Operating Temperature, All Package Types	-40	+105	$^{\circ}C$

This device contains protection circuitry to guard against damage due to high static voltages or electric fields. However, precautions must be taken to avoid applications of any voltage higher than maximum rated voltages to this high-impedance circuit. For proper operation,  $V_{IN}$  and  $V_{OUT}$  should be constrained to the range

GND ( $V_{IN}$  or  $V_{OUT}$ )  $V_{CC}$ .

Unused inputs must always be tied to an appropriate logic voltage level (e.g., either GND or  $V_{CC}$ ). Unused outputs must be left open.

**DC ELECTRICAL CHARACTERISTICS ( $T_A = -40$  to  $+105^\circ\text{C}$ )**

Symbol	Parameter	Test Conditions	Guaranteed Limit			Unit
			Min	Typ	Max	
$V_{IO}$	Maximum Input Offset Voltage	$V_O = 1.4V$ , $V_{CC} = 5.0-30V$ ; $R_S = 0\Omega$ , $V_{ICM} = 0V$ to $V_{CC} - 1.7V$			9.0 5.0*	mV
$\Delta V_{IO}/\Delta T$	Input Offset Voltage Drift	$R_S = 0\Omega$ , $V_{CC} = 30V$		7.0		$\mu V/^\circ C$
$I_{IO}$	Maximum Input Offset Current	$V_{CC} = 5.0V$			150 50*	nA
$\Delta I_{IO}/\Delta T$	Input Offset Current Drift	$R_S = 0\Omega$ , $V_{CC} = 30V$		10		$\mu A/^\circ C$
$I_{IB}$	Maximum Input Bias Current	$V_{CC} = 5.0V$			500 250*	nA
$V_{ICR}$	Input Common Mode Voltage Range	$V_{CC} = 30V$	0		28	V
$I_{CC}$	Maximum Power Supply Current	$R_L = \infty$ , $V_{CC} = 30V$ , $V_O = 0V$ $R_L = \infty$ , $V_{CC} = 5V$ , $V_O = 0V$	0.3 0.3		3 1.2	mA
$A_{VOL}$	Minimum Large Signal Open-Loop Voltage Gain	$V_{CC} = 15V$ , $R_L \geq 2K\Omega$	15 25*			V/mV
$V_{OH}$	Minimum Output High-Level Voltage Swing	$V_{CC} = 30V$ , $R_L = 2K\Omega$ $V_{CC} = 30V$ , $R_L = 10K\Omega$	26 27			V
$V_{OL}$	Maximum Output Low-Level Voltage Swing	$V_{CC} = 5V$ , $R_L = 10K\Omega$			20	mV
CMR	Common Mode Rejection	$V_{CC} = 30V$ , $R_S = 10K\Omega$	65*			dB
PSR	Power Supply Rejection	$V_{CC} = 30V$	65*			dB
CS	Channel Separation	$f = 1KHz$ to $20KHz$ , $V_{CC} = 30V$	-120			dB
$I_{SC}$	Maximum Output Short Circuit to GND	$V_{CC} = 5.0V$ $V_O = 0V$				mA
$I_{source}$	Minimum Source Output Current	$V_{IN+} = 1V$ , $V_{IN-} = 0V$ , $V_{CC} = 15V$ , $V_O = 2V$	10			mA
$I_{sink}$	Minimum Output Sink Current	$V_{IN+} = 0V$ , $V_{IN-} = 1V$ , $V_{CC} = 15V$ , $V_O = 15V$ $V_{IN+} = 0V$ , $V_{IN-} = 1V$ , $V_{CC} = 15V$ , $V_O = 0.2V$	5 10* 12*			mA  $\mu A$
$V_{IDR}$	Differential Input Voltage Range	All $V_{IN}$ GND or V-Supply (if used)			$V_{CC}^*$	V

\* = @25°C

TYPICAL PERFORMANCE CHARACTERISTICS

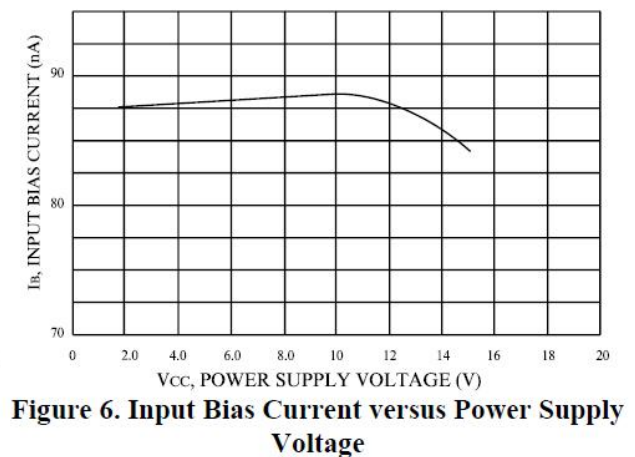
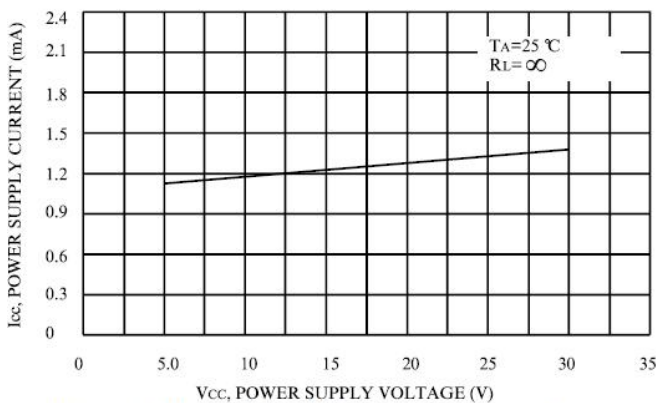
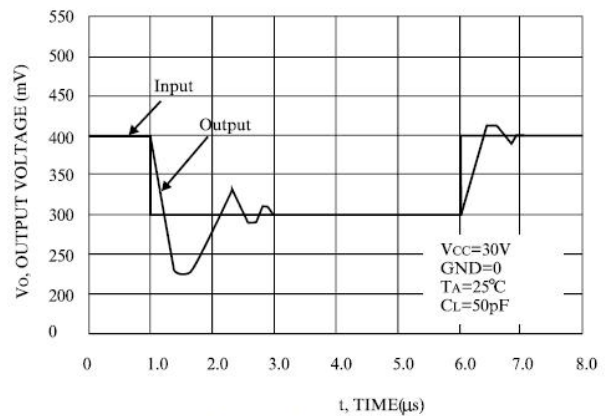
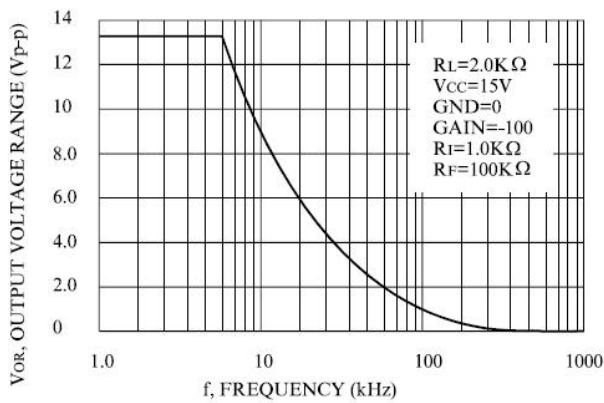
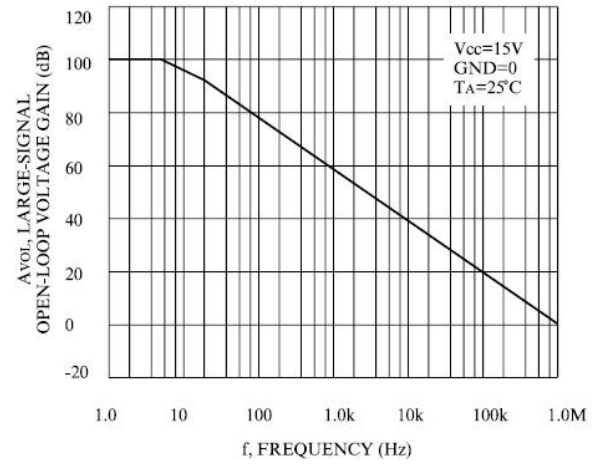
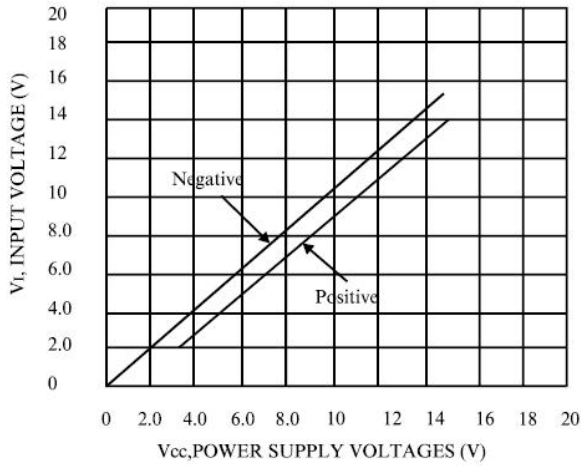

PACKAGE

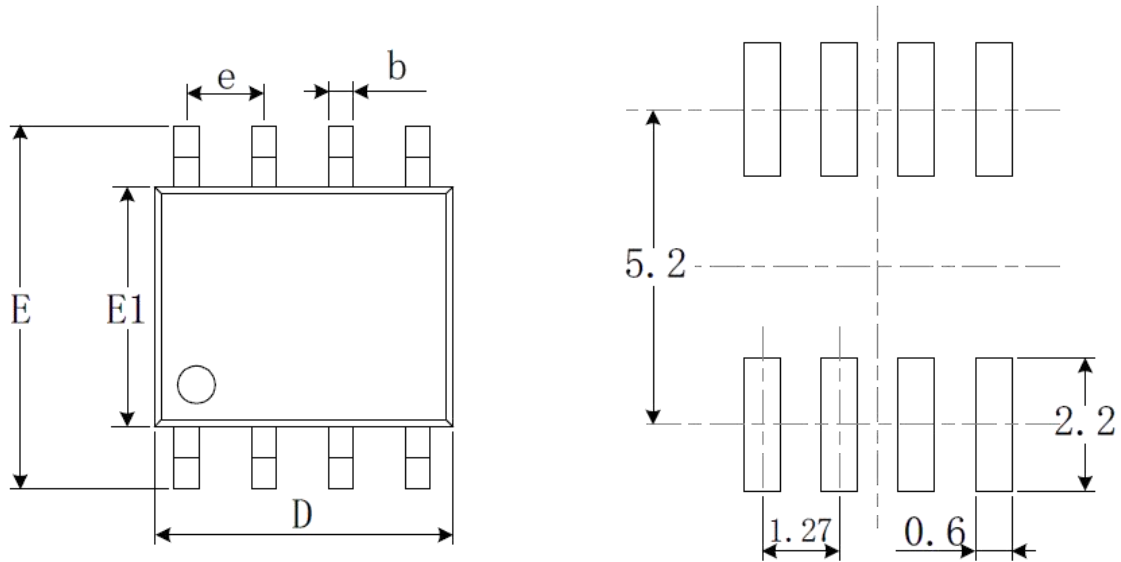

RECOMMENDED LAND PATTERN (Unit: mm)

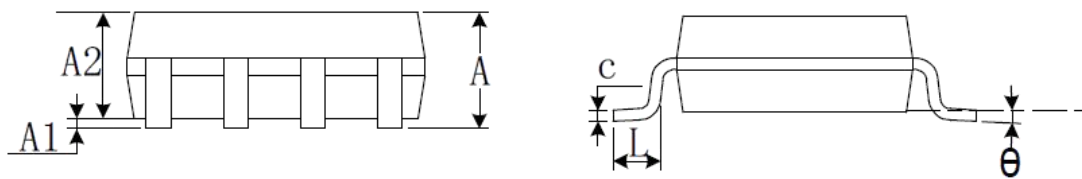

Symbol	Dimensions In Millimeters		Dimensions Inches	
	Min	Max	Min	Max
A	1.350	1.750	0.053	0.069
A1	0.100	0.250	0.004	0.010
A2	1.350	1.550	0.053	0.061
b	0.330	0.510	0.013	0.020
c	0.170	0.250	0.007	0.010
D	4.800	5.000	0.189	0.197
E	5.800	6.200	0.228	0.244
E1	3.800	4.000	0.150	0.157
e	1.270 BSC		0.050 BSC	
L	0.400	1.270	0.016	0.050
θ	0°	8°	0°	8°

## PACKAGE/ORDERING INFORMATION

PRODUCT	ORDERING NUMBER	TEMPRANGE	PACKAGE	PAKEAGE MARKING	TRANSPOT MEDIA,QUANTILY
CBM2904	CBM2904AS8	-40°C~105°C	SOP-8	CBM2904A	Tape and Reel,2500
	CBM2904ATS8	-40°C~105°C	TSSOP-8	CBM2904AT	Tape and Reel,3000

单击下面可查看定价，库存，交付和生命周期等信息

[>>Corebai \(芯佰微\)](#)