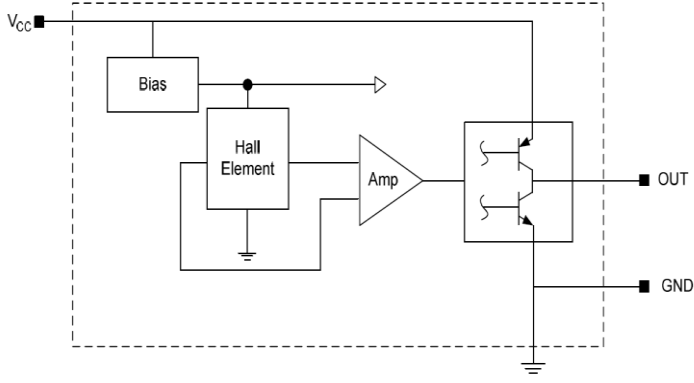
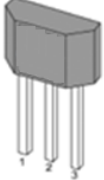
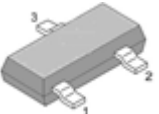
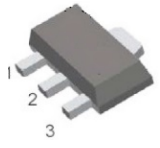

	<b>Cosemitech</b>	<b>CH603/CH604/CH605</b>
	<b>Automotive Product Group</b>	<small>This is advanced information on a new product now in development or undergoing evaluation. Details are subject to change without notice and Cosemitech assumes no obligation for future manufacture of this product. Contact Cosemitech for the latest status.</small>

**REV 0.9**

<b>FEATURES and FUNCTIONAL DIAGRAM</b>	<b>PACKAGE</b>
<ul style="list-style-type: none"> <li>• Power consumption of 4 mA at 5 VDC for energy efficiency</li> <li>• Single Current Sinking or Current Sourcing Output</li> <li>• Linear output for circuit design flexibility</li> <li>• Ratiometric Rail to Rail Linear Output</li> <li>• Precise Sensitivity and Temperature Compensation</li> <li>• Wide Operating Voltage Range: Supply Voltage 3.0~15V</li> <li>• Sensitivity at 5V: <ul style="list-style-type: none"> <li>3.3mV/Gauss (CH603)</li> <li>2.5mV/Gauss (CH604)</li> <li>5.0mV/Gauss (CH605)</li> </ul> </li> <li>• Specified Operating Temperature Range: From -40°C~150°C</li> <li>• Responds to either positive or negative gauss</li> <li>• Quad Hall sensing element for stable output</li> <li>• Lead Free Package: Flat TO-92, SOT-89-3L, SOT-23-3L</li> <li>• High ESD Protection</li> <li>• RoHS Compliant 2011/65/EU</li> </ul> <p><b>Functional Block Diagram</b></p> 	 <p style="text-align: center;">TO-92S</p>   <p style="display: flex; justify-content: space-around;"> <span>SOT-23-3L</span> <span>SOT-89-3L</span> </p>
	<p><b>APPLICATIONS</b></p> <p>Automotive, Industrial, Home, appliances,</p> <ul style="list-style-type: none"> <li>Current sensing</li> <li>Speed Detection</li> <li>Position Detection</li> <li>Magnetic Encoder</li> <li>Solid-State Switch</li> <li>Ferrous metal sensing</li> <li>Liquid level sensing</li> <li>Vibration sensing</li> <li>Weight sensing</li> </ul>
<p><b>DESCRIPTION</b></p> <p>The CH603/CH604/CH605 family is high performance ratiometric linear hall effect sensor, produced with Bipolar technology; it is high performance small versatile linear Hall-effect devices which are operated by the magnetic field from a permanent magnet or an electromagnet. The ratiometric output voltage is set by the supply voltage and varies in proportion to the strength of the magnetic field. The CH603/CH604/CH605 family has a quiescent output voltage that is 50% of the supply voltage.</p> <p>The integrated circuitry provides increased temperature stability and sensitivity. The CH603/CH604/CH605 provide high accuracy and temperature compensation. The linear hall sensors have an operating temperature range from -40 to +150°C, appropriate for home appliances, industrial and automotive environments. They respond to either South or North pole.</p>	

	<b>Cosemitech</b>	<b>CH603/CH604/CH605</b>
	<b>Automotive Product Group</b>	<small>. This is advanced information on a new product now in development or undergoing evaluation. Details are subject to change without notice and Cosemitech assumes no obligation for future manufacture of this product. Contact Cosemitech for the latest status.</small>

**REV 0.9**

## Table of Contents

1. Product Family Members.....	3
2. Pin Definitions and Descriptions .....	3
3. Absolute Maximum Ratings .....	3
4. ESD Protections .....	4
5. Function Description .....	4
6. Magnetic Activation .....	4
7. Transfer Characteristics.....	4
8. Parameters Specification.....	5
9. Typical Application Circuit .....	5
10. Package Information .....	6

	<b>Cosemitech</b>	<b>CH603/CH604/CH605</b>
	<b>Automotive Product Group</b>	<small>This is advanced information on a new product now in development or undergoing evaluation. Details are subject to change without notice and Cosemitech assumes no obligation for future manufacture of this product. Contact Cosemitech for the latest status.</small>

**REV 0.9**

## 1. Product Family Members

Part Number	Marking ID	Description
CH603ATB	C603	Linear Hall sensor IC, flat, TO-92S package, bulk packing (1000 units per bag)
CH603AER	C603	Linear Hall sensor IC, SOT-89-3L package, tape and reel packing (1000 units per reel)
CH603ASR	C603	Linear Hall sensor IC, SOT-23-3L package, tape and reel packing (3000 units per reel)
CH604ATB	C604	Linear Hall sensor IC, flat, TO-92S package, bulk packing (1000 units per bag)
CH604AER	C604	Linear Hall sensor IC, SOT-89-3L package, tape and reel packing (1000 units per reel)
CH604ASR	C604	Linear Hall sensor IC, SOT-23-3L package, tape and reel packing (3000 units per reel)
CH605ATB	C605	Linear Hall sensor IC, flat, TO-92S package, bulk packing (1000 units per bag)
CH605AER	C605	Linear Hall sensor IC, SOT-89-3L package, tape and reel packing (1000 units per reel)
CH605ASR	C605	Linear Hall sensor IC, SOT-23-3L package, tape and reel packing (3000 units per reel)

## 2. Pin Definitions and Descriptions

TO-92S (T)	SOT-89-3L (E)	SOT-23-3L (E)	Name	Type	Function
1	1	1	VDD	Supply	Supply Voltage pin
2	2	3	GND	Ground	Ground pin
3	3	2	OUT	Output	Output pin

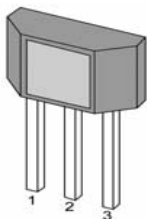

**TO-92S**

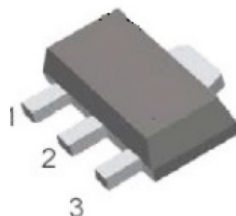

**SOT-89-3L**

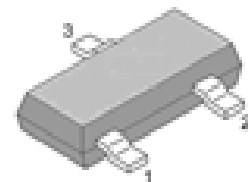

**SOT-23-3L**

## 3. Absolute Maximum Ratings

Parameter	Symbol	Min	Max	Units
Supply Voltage	V <sub>DD</sub>	-	18	V
VDD Reverse Voltage VDD	V <sub>RDD</sub>	-	-0.3	V
Output Voltage	V <sub>OUT</sub>	-0.3	18	V
Output Current	I <sub>OUT</sub>	-	5	mA
Operating Ambient Temperature	T <sub>A</sub>	-40	150	°C
Storage Temperature	T <sub>S</sub>	-50	150	°C
Junction temperature	T <sub>J</sub>	-50	165	°C
Magnetic Flux	B	No Limit		Gauss

Note: Exceeding the absolute maximum ratings may cause permanent damage. Exposure to absolute-maximum-rated conditions for extended periods may affect device reliability.

	<b>Cosemitech</b>	<b>CH603/CH604/CH605</b>
	<b>Automotive Product Group</b>	<small>. This is advanced information on a new product now in development or undergoing evaluation. Details are subject to change without notice and Cosemitech assumes no obligation for future manufacture of this product. Contact Cosemitech for the latest status.</small>

**REV 0.9**

#### 4. ESD Protections

Parameter	Value	Unit
All pins <sup>1)</sup>	+/-6000	V
All pins <sup>2)</sup>	+/-400	V
All pins <sup>3)</sup>	+/-1500	V

1) HBM (human body mode, 100pF, 1.5 kohm ) according to MIL-STD-883H Method 3015.8

2) MM (Machine Mode C=200pF, R=0Ω) according to JEDEC EIA/JESD22-A115

3) CDM (charged device mode) according to JEDEC EIA/JESD22-C101F

#### 5. Function Description

The CH603/CH604/CH605 family MRL (Miniature Ratiometric Linear) sensors are small, versatile linear Hall effect devices which are operated by the magnetic field from a permanent magnet or an electromagnet. The ratiometric output voltage is set by the supply voltage and varies in proportion to the strength of the magnetic field.

The integrated circuitry provides increased temperature stability, sensitivity and temperature compensation. These linear position sensors have an operating temperature range of -40°C to +150°C, appropriate for industrial and automotive environments. They respond to either positive or negative gauss, monitoring either or both magnetic poles.

The quad Hall sensing element minimizes the effects of mechanical or thermal stress on the output. The product providing a robust design over a wide temperature range. Rail-to-rail operation (over full voltage range) provides a more usable signal for higher accuracy.

The CH603/CH604/CH605 family has a typical sinking or sourcing output of 1.5 mA continuous, uses 4 mA of supply current at 5.0 volts and 25°C, and provides predictable performance over the full temperature range. The CH603/CH604/CH605 family Series sensors have wider null and sensitivity tolerances.

#### 6. Magnetic Activation

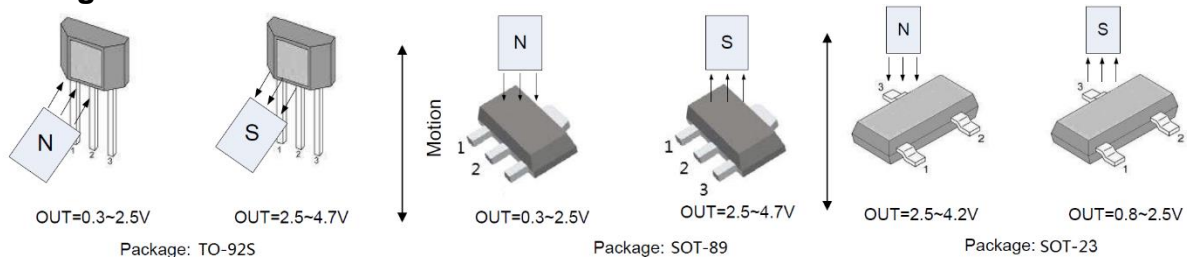

#### 7. Transfer Characteristics

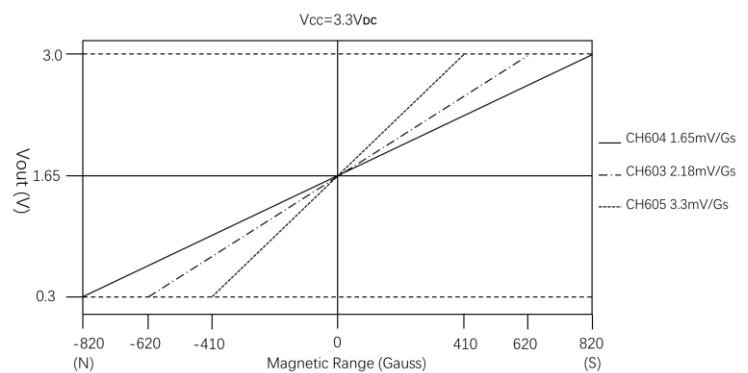
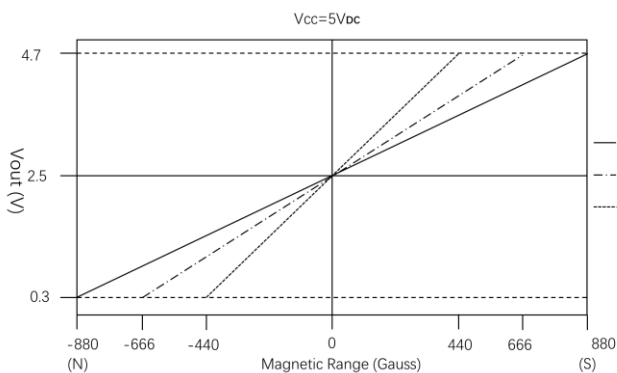

	<b>Cosemitech</b>	<b>CH603/CH604/CH605</b>
	<b>Automotive Product Group</b>	<small>This is advanced information on a new product now in development or undergoing evaluation. Details are subject to change without notice and Cosemitech assumes no obligation for future manufacture of this product. Contact Cosemitech for the latest status.</small>

**REV 0.9**

**8. Parameters Specification (At V<sub>DD</sub>=5V, T<sub>A</sub>= -40 °C to 150 °C except where otherwise specified.)**

Symbol	Parameter	Test Condition	Min	Typ	Max	Units	
V <sub>DD</sub>	Supply voltage	-40 °C to 150 °C	3.0	5.0	15	V	
I <sub>DD</sub>	Supply Current	B=0		4	8	mA	
V <sub>H</sub>	Output voltage	B=+1000 Gs			0.4	V	
V <sub>L</sub>		B=-1000 Gs	4.7			V	
V <sub>NULL</sub>	Quiescent Voltage	V <sub>DD</sub> =5V B=0 at 25 °C	2.42	2.5	2.58	V	
V <sub>NULL</sub>	Quiescent Voltage	V <sub>DD</sub> =3.3V B=0 at 25 °C	1.58	1.65	1.72	V	
I <sub>SINK</sub>	Sink Current	V <sub>DD</sub> =3V T <sub>A</sub> =25°C	-0.8			mA	
I <sub>SINK</sub>		V <sub>DD</sub> =5V T <sub>A</sub> =25°C	-1			mA	
I <sub>SOURCE</sub>	Source Current	V <sub>DD</sub> =3V T <sub>A</sub> =25°C			1.5	mA	
I <sub>SOURCE</sub>		V <sub>DD</sub> =5V T <sub>A</sub> =25°C			2.0	mA	
V <sub>N</sub>	Output Referred Noise(CH605)	TA = 25°C, CL = 0.1 μF		4.2		mV(p-p)	
	Output Referred Noise(CH603)	TA = 25°C, CL= 0.1 μF		3.1		mV(p-p)	
	Output Referred Noise(CH604)	TA = 25°C, CL = 0.1 μF		2.6		mV(p-p)	
L <sub>IN</sub>	Linearity		-5		+5	%	
V <sub>NULL(T)</sub>	Delta Vnull as temperature		-5		+5	%	
V <sub>NULL(V)</sub>	Ratiometry, Vnull		-5		+5	%	
SENS(T)	Delta Sens as temperature		-10		+10	%	
S <sub>ENS</sub>	Sensitivity(CH603)	VCC=5V, TA=25°C		3.3		mV/Gs	
	Sensitivity(CH604)			2.5		mV/Gs	
	Sensitivity(CH605)			5		mV/Gs	
S <sub>ENS</sub>	Sensitivity(CH603)	VCC=3.3V, TA=25°C		2.18		mV/Gs	
	Sensitivity(CH604)			1.65		mV/Gs	
	Sensitivity(CH605)			3.3		mV/Gs	
B+ B-	Magnetic Range (CH603)	VCC=5V, TA=25°C		666		Gauss	
				-666		Gauss	
B+ B-	Magnetic Range (CH604)			880		Gauss	
				-880		Gauss	
B+ B-	Magnetic Range (CH605)			440		Gauss	
				-440		Gauss	
B+ B-	Magnetic Range (CH603)		VCC=3.3V, TA=25°C		620		Gauss
					-620		Gauss
B+ B-	Magnetic Range (CH604)				820		Gauss
				-820		Gauss	
B+ B-	Magnetic Range (CH605)			410		Gauss	
				-410		Gauss	

### 9. Typical Application Circuit

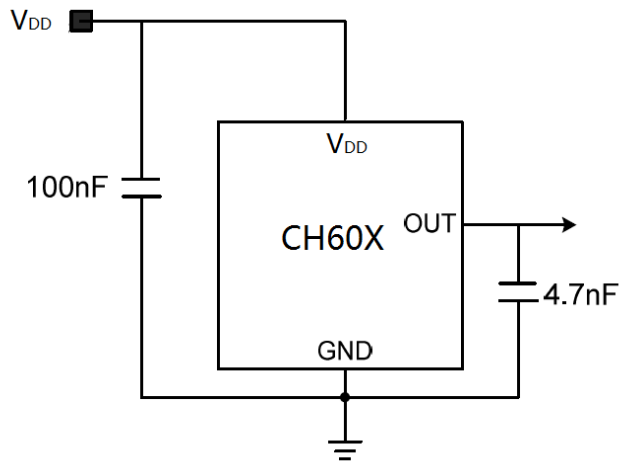

**10. Package Information:**

**PACKAGE DESIGNATOR**

TO-92

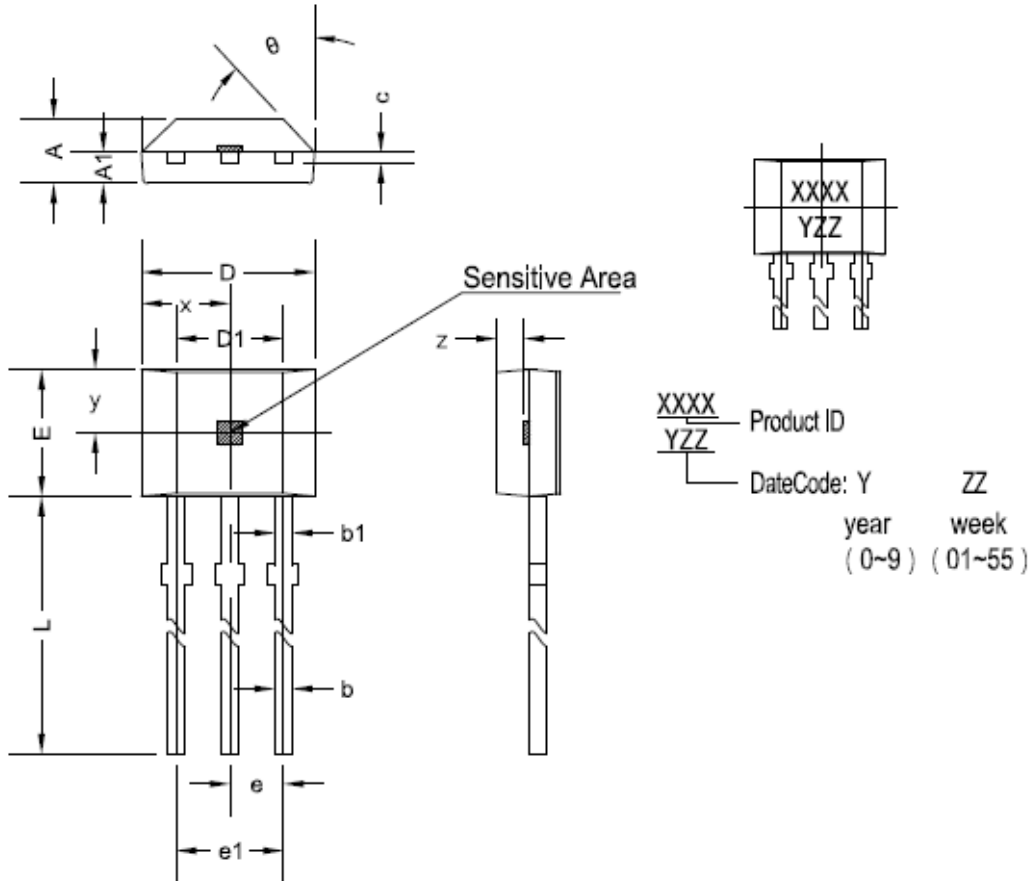

Symbol	Dimensions in Millimeters		Dimensions in Inches	
	Min	Max	Min	Max
A	1.420	1.670	0.056	0.066
A1	0.660	0.860	0.026	0.034
b	0.350	0.560	0.014	0.022
b1	0.400	0.550	0.016	0.022
C	0.360	0.510	0.014	0.020
D	3.900	4.200	0.154	0.165
D1	2.970	3.270	0.117	0.129
E	2.900	3.280	0.114	0.129
e	1.270 TYP		0.050 TYP	
e1	2.440	2.640	0.096	0.104
L	13.500	15.500	0.531	0.610
x	2.025TYP		0.080TYP	
y	1.545TYP		0.061TYP	
z	0.500TYP		0.020TYP	
theta	45°TYP		45°TYP	

**PACKAGE DESIGNATOR**  
**SOT-89-3L**

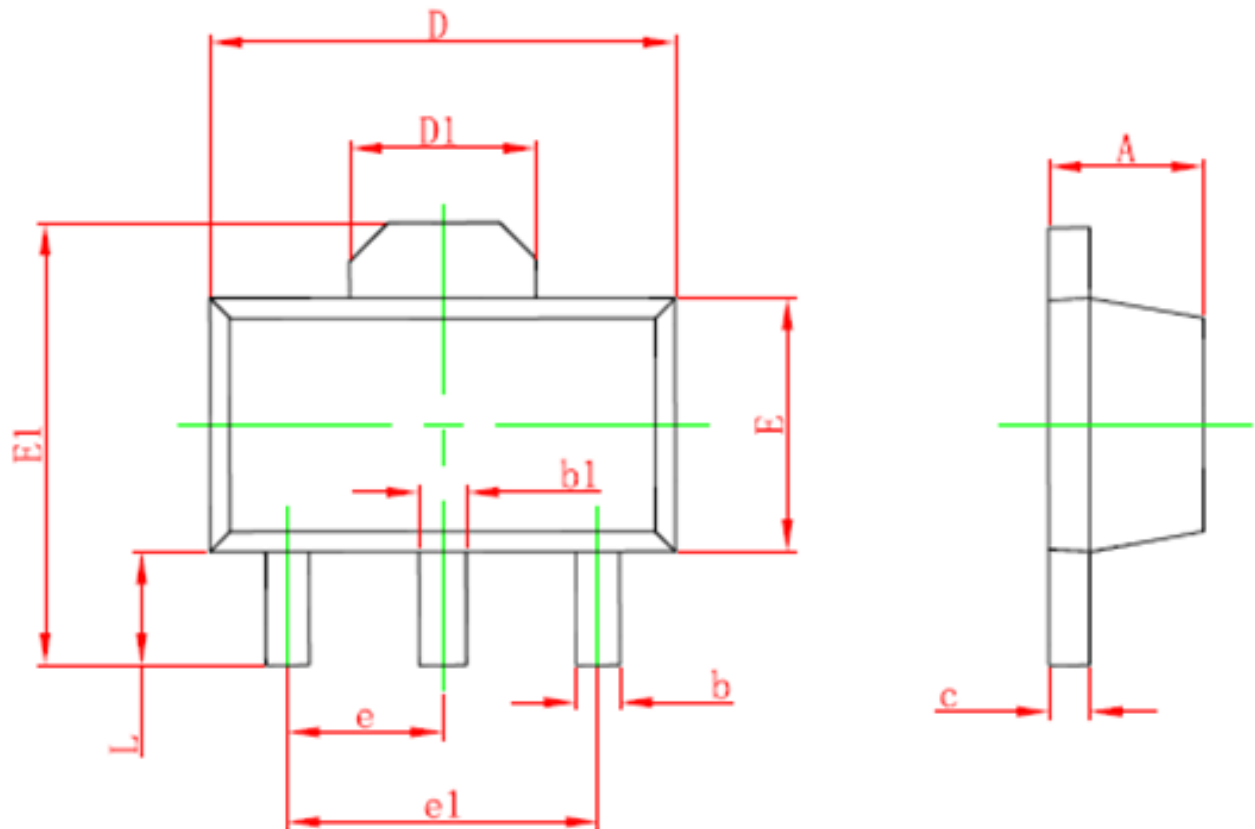

Symbol	Dimensions In Millimeters		Dimensions In Inches	
	Min.	Max.	Min.	Max.
A	1.400	1.600	0.055	0.063
b	0.320	0.520	0.013	0.020
b1	0.400	0.580	0.016	0.023
c	0.350	0.440	0.014	0.017
D	4.400	4.600	0.173	0.181
D1	1.550 REF.		0.061 REF.	
E	2.300	2.600	0.091	0.102
E1	3.940	4.250	0.155	0.167
e	1.500 TYP.		0.060 TYP.	
e1	3.000 TYP.		0.118 TYP.	
L	0.900	1.200	0.035	0.047



PACKAGE DESIGNATOR  
SOT-23-3L

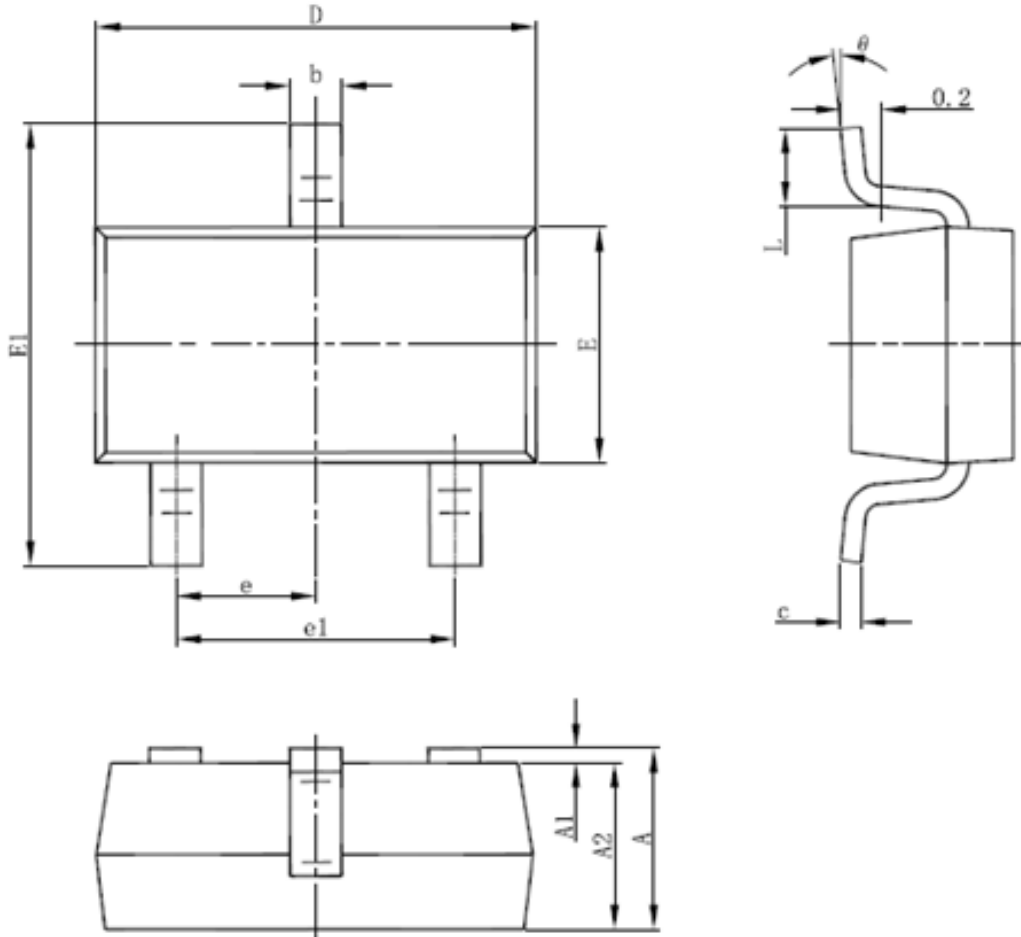

Symbol	Dimensions In Millimeters		Dimensions In Inches	
	Min	Max	Min	Max
A	1.050	1.250	0.041	0.049
A1	0.000	0.100	0.000	0.004
A2	1.050	1.150	0.041	0.045
b	0.300	0.500	0.012	0.020
c	0.100	0.200	0.004	0.008
D	2.820	3.020	0.111	0.119
E	1.500	1.700	0.059	0.067
E1	2.650	2.950	0.104	0.116
e	0.950(BSC)		0.037(BSC)	
e1	1.800	2.000	0.071	0.079
L	0.300	0.600	0.012	0.024
$\theta$	0°	8°	0°	8°

	<b>Cosemitech</b>	CH603/CH604/CH605
	<b>Automotive Product Group</b>	<small>. This is advanced information on a new product now in development or undergoing evaluation. Details are subject to change without notice and Cosemitech assumes no obligation for future manufacture of this product. Contact Cosemitech for the latest status.</small>

**REV 0.9**

Information furnished is believed to be accurate and reliable. However, Cosemitech assumes no responsibility for the consequences of use of such information nor for any infringement of patents or other rights of third parties which may result from its use. No license is granted by implication or otherwise under any patent or patent rights of Cosemitech. Specification mentioned in this publication are subject to change without notice. This publication supersedes and replaces all information previously supplied. Cosemitech products are not authorized for use as critical components in life support devices or systems without express written approval of Cosemitech.

The Cosemitech logo is a registered trademark of Cosemitech

单击下面可查看定价，库存，交付和生命周期等信息

[>>cosemitech\(意瑞半导体\)](#)