



CS20N50 ANR

General Description:

CS20N50 ANR the silicon N-channel Enhanced VDMOSFET, is obtained by the self-aligned planar Technology which reduce the conduction loss, improve switching performance and enhance the avalanche energy. The transistor can be used in various power switching circuit for system miniaturization and higher efficiency. The package form is TO-3P(N), which accords with the RoHS standard.

Features:

- I **Fast Switching**
- I **Low ON Resistance**($R_{dson} \leq 0.3\Omega$)
- I **Low Gate Charge** (Typical Data:52nC)
- I **Low Reverse transfer capacitances**(Typical:16pF)
- I **100% Single Pulse avalanche energy Test**

Applications:

Power switch circuit of adaptor and charger.

Absolute ($T_J = 25^\circ\text{C}$ unless otherwise specified):

| Symbol | Parameter | Rating | Units |
|----------------|--|-----------------|---------------------|
| V_{DSS} | Drain-to-Source Voltage | 500 | V |
| I_D | Continuous Drain Current $T_C = 25^\circ\text{C}$ | 20 | A |
| | Continuous Drain Current $T_C = 100^\circ\text{C}$ | 12.5 | A |
| I_{DM}^{a1} | Pulsed Drain Current $T_C = 25^\circ\text{C}$ | 80 | A |
| V_{GS} | Gate-to-Source Voltage | ± 30 | V |
| E_{AS}^{a2} | Single Pulse Avalanche Energy | 1200 | mJ |
| dv/dt^{a3} | Peak Diode Recovery dv/dt | 5.0 | V/ns |
| P_D | Power Dissipation $T_C = 25^\circ\text{C}$ | 260 | W |
| | Derating Factor above 25°C | 2.08 | W/ $^\circ\text{C}$ |
| T_J, T_{stg} | Operating Junction and Storage Temperature Range | 150, -55 to 150 | $^\circ\text{C}$ |
| T_L | Maximum Temperature for Soldering | 300 | $^\circ\text{C}$ |

| | | |
|-----------------------------|------|----------|
| V_{DSS} | 500 | V |
| I_D | 20 | A |
| $P_D(T_C=25^\circ\text{C})$ | 260 | W |
| $R_{DS(ON)Typ}$ | 0.24 | Ω |

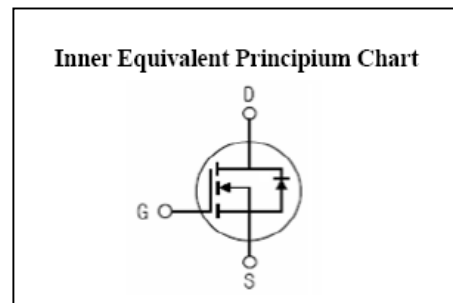
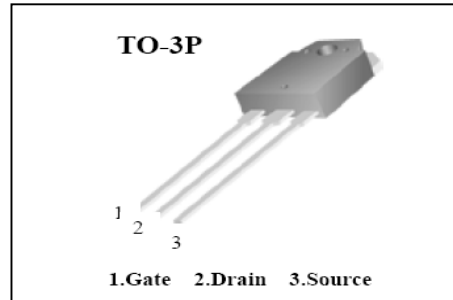

Electrical Characteristics ($T_J = 25^\circ\text{C}$ unless otherwise specified):

| OFF Characteristics | | | | | | |
|------------------------------|-----------------------------------|--|--------|------|------|---------------------|
| Symbol | Parameter | Test Conditions | Rating | | | Unit s |
| | | | Min. | Typ. | Max. | |
| V_{DSS} | Drain to Source Breakdown Voltage | $V_{GS}=0V, I_D=250\mu A$ | 500 | -- | -- | V |
| $\Delta BV_{DSS}/\Delta T_J$ | Bvdss Temperature Coefficient | $I_D=250\mu A, \text{Reference } 25^\circ\text{C}$ | -- | 0.6 | -- | V/ $^\circ\text{C}$ |
| I_{DSS} | Drain to Source Leakage Current | $V_{DS}=500V, V_{GS}=0V, T_J=25^\circ\text{C}$ | -- | -- | 1 | μA |
| | | $V_{DS}=400V, V_{GS}=0V, T_J=125^\circ\text{C}$ | -- | -- | 100 | μA |
| $I_{GSS(F)}$ | Gate to Source Forward Leakage | $V_{GS}=+30V$ | -- | -- | 100 | nA |
| $I_{GSS(R)}$ | Gate to Source Reverse Leakage | $V_{GS}=-30V$ | -- | -- | -100 | nA |

| ON Characteristics | | | | | | |
|--|-------------------------------|-----------------------------------|--------|------|------|----------|
| Symbol | Parameter | Test Conditions | Rating | | | Units |
| | | | Min. | Typ. | Max. | |
| $R_{DS(ON)}$ | Drain-to-Source On-Resistance | $V_{GS}=10V, I_D=10A$ | -- | 0.24 | 0.3 | Ω |
| $V_{GS(TH)}$ | Gate Threshold Voltage | $V_{DS} = V_{GS}, I_D = 250\mu A$ | 2.0 | -- | 4.0 | V |
| Pulse width $t_p \leq 300\mu s, \delta \leq 2\%$ | | | | | | |

| Dynamic Characteristics | | | | | | |
|--------------------------------|------------------------------|---|--------|------|------|-------|
| Symbol | Parameter | Test Conditions | Rating | | | Units |
| | | | Min. | Typ. | Max. | |
| g_{fs} | Forward Trans conductance | $V_{DS}=15V, I_D=10A$ | -- | 18 | -- | S |
| C_{iss} | Input Capacitance | $V_{GS} = 0V, V_{DS} = 25V, f = 1.0MHz$ | -- | 2919 | -- | pF |
| C_{oss} | Output Capacitance | | -- | 277 | -- | |
| C_{rss} | Reverse Transfer Capacitance | | -- | 16 | -- | |

| Resistive Switching Characteristics | | | | | | |
|--|---------------------------------|--|--------|------|------|-------|
| Symbol | Parameter | Test Conditions | Rating | | | Units |
| | | | Min. | Typ. | Max. | |
| $t_{d(ON)}$ | Turn-on Delay Time | $I_D = 20A, V_{DD} = 250V, R_G = 10\Omega$ | -- | 34 | -- | ns |
| t_r | Rise Time | | -- | 65 | -- | |
| $t_{d(OFF)}$ | Turn-Off Delay Time | | -- | 82 | -- | |
| t_f | Fall Time | | -- | 45 | -- | |
| Q_g | Total Gate Charge | $I_D = 20A, V_{DD} = 400V, V_{GS} = 10V$ | -- | 52 | -- | nC |
| Q_{gs} | Gate to Source Charge | | -- | 12.6 | -- | |
| Q_{gd} | Gate to Drain ("Miller") Charge | | -- | 18.6 | -- | |

| Source-Drain Diode Characteristics | | | | | | |
|--|--|--|--------|------|------|-------|
| Symbol | Parameter | Test Conditions | Rating | | | Units |
| | | | Min. | Typ. | Max. | |
| I_S | Continuous Source Current (Body Diode) | $T_C = 25\text{ }^\circ\text{C}$ | -- | -- | 20 | A |
| I_{SM} | Maximum Pulsed Current (Body Diode) | | -- | -- | 80 | A |
| V_{SD} | Diode Forward Voltage | $I_S=20\text{A}, V_{GS}=0\text{V}$ | -- | -- | 1.5 | V |
| t_{rr} | Reverse Recovery Time | $I_S=20\text{A}, T_j = 25\text{ }^\circ\text{C}$ $dI_F/dt=100\text{A}/\mu\text{s},$ $V_{GS}=0\text{V}$ | -- | 535 | -- | ns |
| Q_{rr} | Reverse Recovery Charge | | -- | 5671 | -- | nC |
| I_{RRM} | Reverse Recovery Current | | -- | 21.2 | -- | A |
| Pulse width $t_p \leq 300\mu\text{s}, \delta \leq 2\%$ | | | | | | |

| Symbol | Parameter | Max. | Units |
|-----------------|---------------------|------|---------------------------|
| $R_{\theta JC}$ | Junction-to-Case | 0.48 | $^\circ\text{C}/\text{W}$ |
| $R_{\theta JA}$ | Junction-to-Ambient | 40 | $^\circ\text{C}/\text{W}$ |

^{a1}: Repetitive rating; pulse width limited by maximum junction temperature

^{a2}: $L=10\text{mH}, I_D=15.5\text{A}, \text{Start } T_j=25\text{ }^\circ\text{C}$

^{a3}: $I_{SD}=20\text{A}, di/dt \leq 100\text{A}/\mu\text{s}, V_{DD} \leq BV_{DS}, \text{Start } T_j=25\text{ }^\circ\text{C}$

Characteristics Curve:

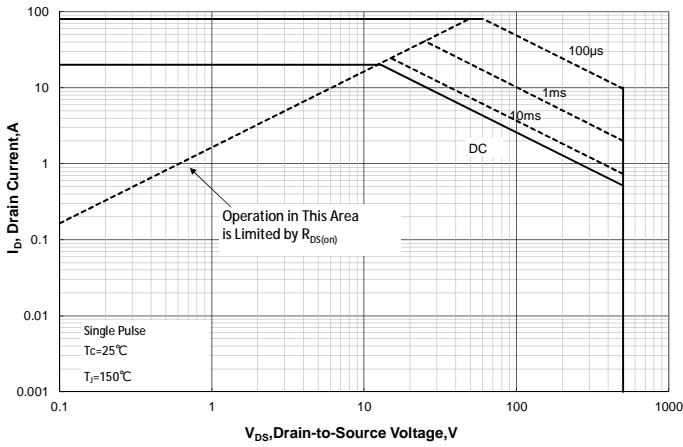

Figure 1 Maximum Forward Bias Safe Operating Area

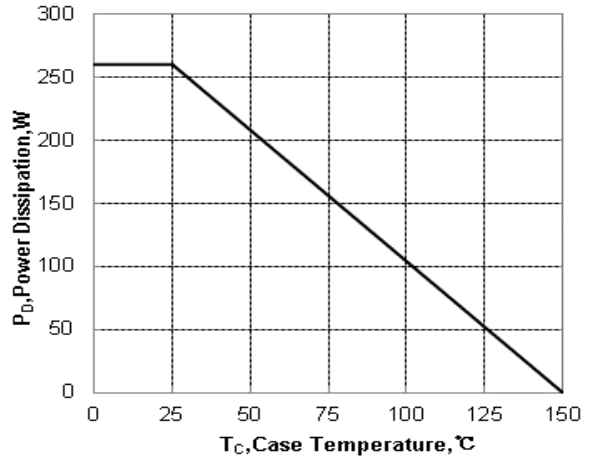

Figure 2 Maximum Power Dissipation vs Case Temperature

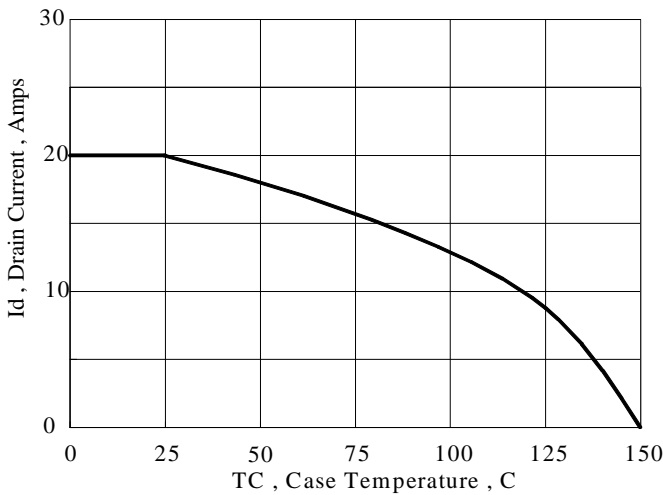

Figure 3 Maximum Continuous Drain Current vs Case Temperature

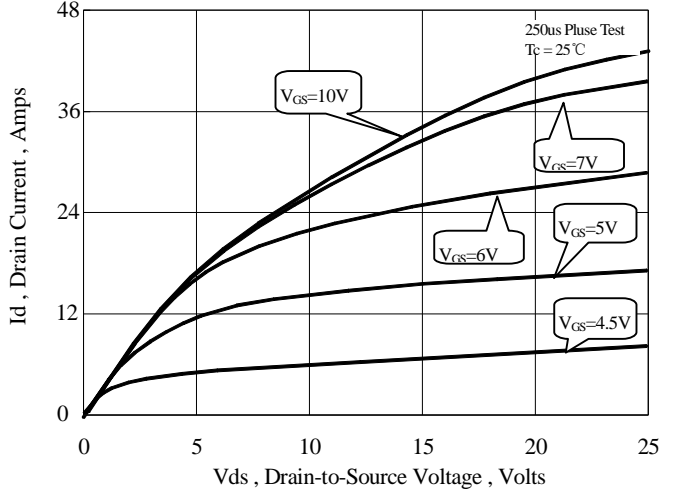

Figure 4 Typical Output Characteristics

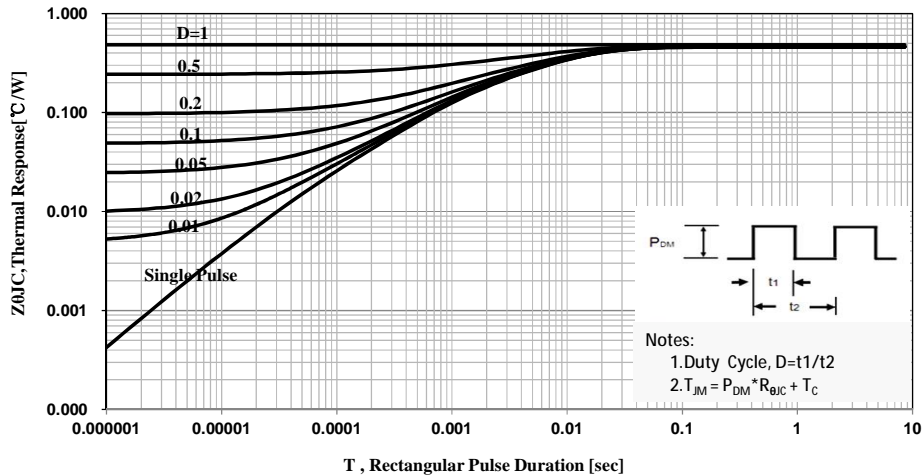

Figure 5 Maximum Effective Thermal Impedance, Junction to Case

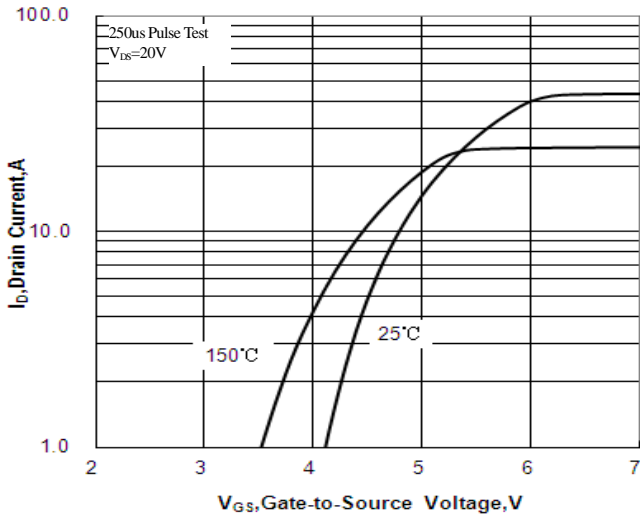

Figure 6 Typical Transfer Characteristics

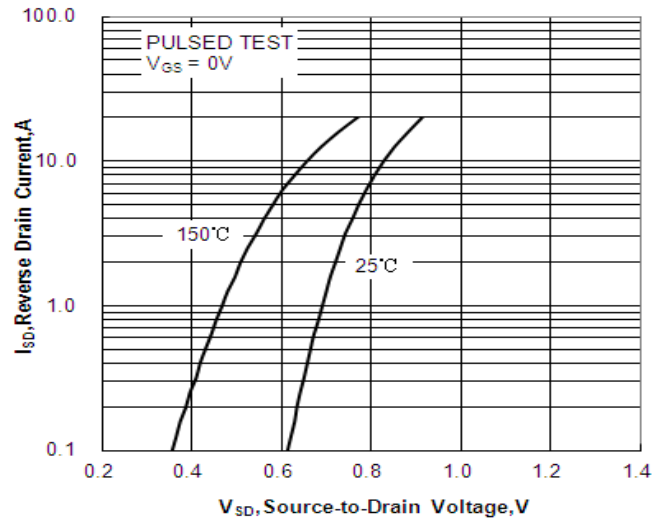

Figure 7 Typical Body Diode Transfer Characteristics

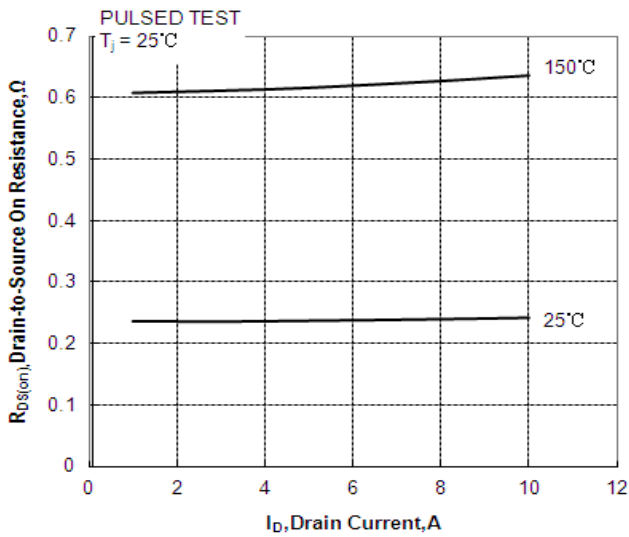

Figure 8 Typical Drain to Source ON Resistance vs Drain Current

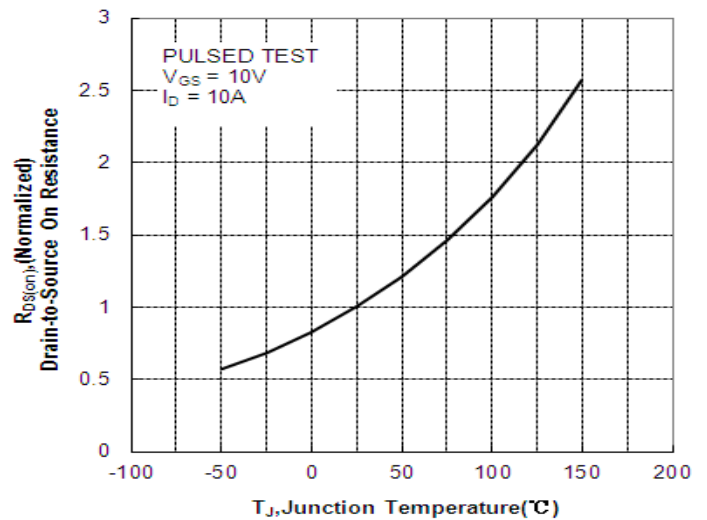

Figure 9 Typical Drain to Source on Resistance vs Junction Temperature

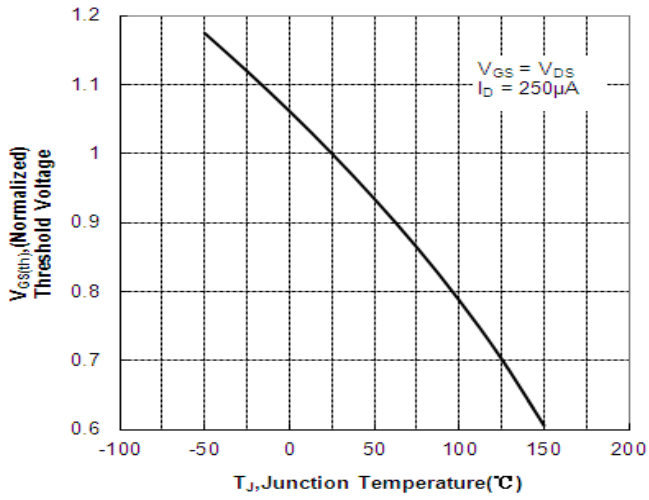

Figure 10 Typical Theshold Voltage vs Junction Temperature

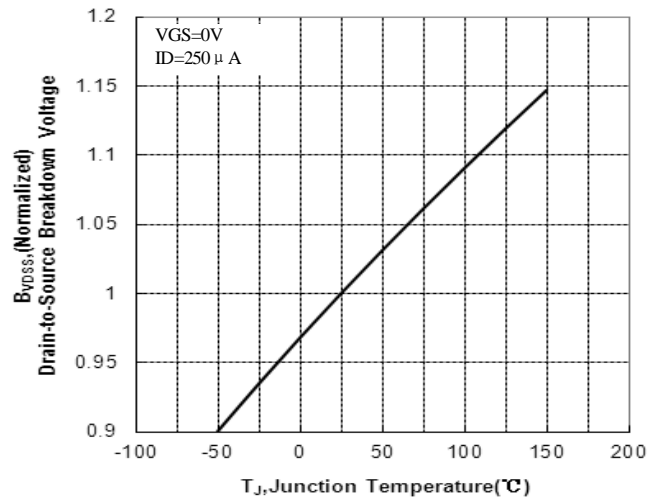

Figure 11 Typical Breakdown Voltage vs Junction Temperature

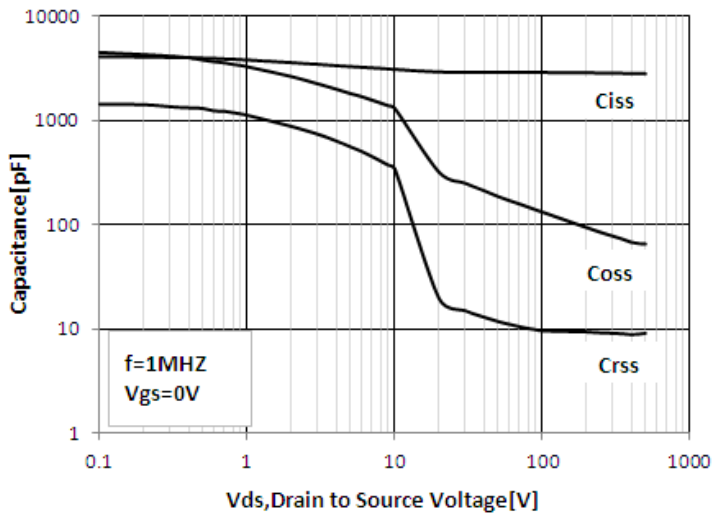

Figure 12 Typical Capacitance vs Drain to Source Voltage

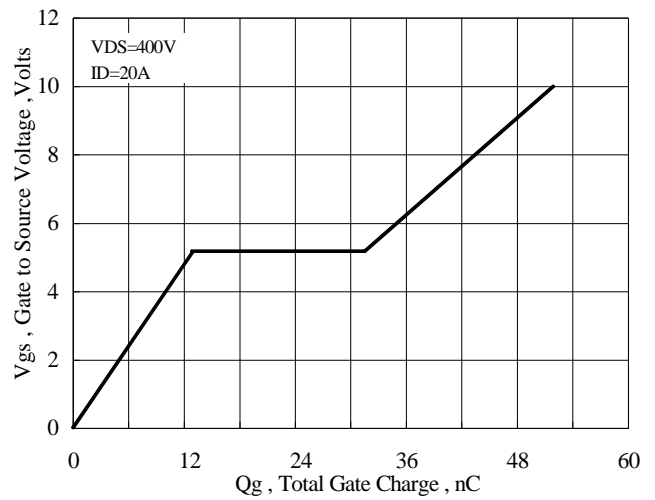

Figure 13 Typical Gate Charge vs Gate to Source Voltage

Test Circuit and Waveform:



Figure 14. Gate Charge Test Circuit



Figure 15. Gate Charge Waveforms



Figure 16. Resistive Switching Test Circuit



Figure 17. Resistive Switching Waveforms



Figure 18. Diode Reverse Recovery Test Circuit

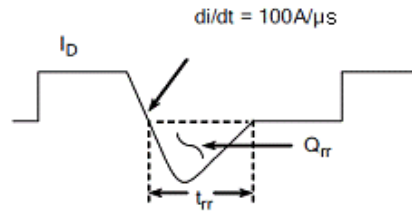

Figure 19. Diode Reverse Recovery Waveform

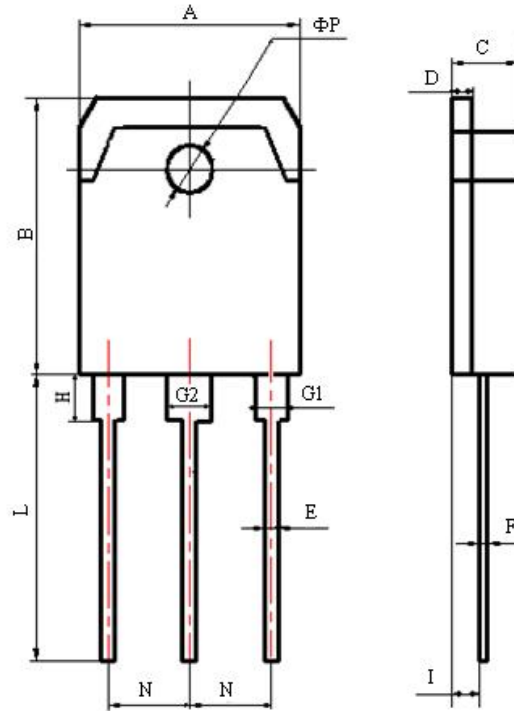

Figure 20. Unclamped Inductive Switching Test Circuit



Figure 21. Unclamped Inductive Switching Waveform

Package Information:



| Items | Values(mm) | |
|-------|------------|-------|
| | MIN | MAX |
| A | 15.00 | 16.00 |
| B | 19.20 | 20.60 |
| C | 4.60 | 5.00 |
| D | 1.40 | 1.60 |
| E | 0.90 | 1.10 |
| F | 0.50 | 0.70 |
| G1 | 2.00 | 2.20 |
| G2 | 3.00 | 3.20 |
| H | 3.00 | 3.70 |
| I | 1.20 | 1.70 |
| | 2.70 | 2.90 |
| L* | 19.00 | 21.00 |
| N | 5.25 | 5.65 |
| Φ P | 3.10 | 3.30 |

*: adjustable

TO-3P(N) Package

The name and content of poisonous and harmful material in products

| | Hazardous Substance | | | | | | | | | |
|--------------|---|-------|------------|--------|-------|-------|-------|-------|-------|-------|
| | Pb | Hg | Cd | Cr(VI) | PBB | PBDE | DIBP | DEHP | DBP | BBP |
| Limit | ≤0.1% | ≤0.1% | ≤ 0.01% | ≤0.1% | ≤0.1% | ≤0.1% | ≤0.1% | ≤0.1% | ≤0.1% | ≤0.1% |
| Lead Frame | ○ | ○ | ○ | ○ | ○ | ○ | ○ | ○ | ○ | ○ |
| Molding | ○ | ○ | ○ | ○ | ○ | ○ | ○ | ○ | ○ | ○ |
| Chip | ○ | ○ | ○ | ○ | ○ | ○ | ○ | ○ | ○ | ○ |
| Wire Bonding | ○ | ○ | ○ | ○ | ○ | ○ | ○ | ○ | ○ | ○ |
| Solder | × | ○ | ○ | ○ | ○ | ○ | ○ | ○ | ○ | ○ |
| Note | ○: Means the hazardous material is under the criterion of 2011/65/EU. ×: Means the hazardous material exceeds the criterion of 2011/65/EU. The plumbum element of solder exist in products presently, but within the allowed range of Eurogroup's RoHS. | | | | | | | | | |

Warnings

1. Exceeding the maximum ratings of the device in performance may cause damage to the device, even the permanent failure, which may affect the dependability of the machine. It is suggested to be used under 80 percent of the maximum ratings of the device.
2. When installing the heat sink, please pay attention to the torsional moment and the smoothness of the heat sink.
3. VDMOSFETs is the device which is sensitive to the static electricity, it is necessary to protect the device from being damaged by the static electricity when using it.
4. This publication is made by Huajing Microelectronics and subject to regular change without notice.

WUXI CHINA RESOURCES HUAJING MICROELECTRONICS CO., LTD.

Add: No.14 Liangxi RD. Wuxi, Jiangsu, China Mail:214061 <https://www.crmicro.com>
Tel: +86 0510-85807228 Fax: +86- 0510-85800864

Marketing Part: Post: 214061 Tel: +86 0510-81805277/81805336
Fax: +86 0510-85800360/85803016

Application and Service: Post: 214061 Tel / Fax: +86- 0510-81805243/81805110

单击下面可查看定价，库存，交付和生命周期等信息

[>>CRMICRO\(华润微\)](#)