

Features

- CRM(CQ) Super_Junction technology
- Much lower Ron*A performance for On-state efficiency
- Much lower FOM for fast switching efficiency

Product Summary

VDS	650V
R _{DS(on)_typ}	0.6Ω
I _D	7A

Applications

- LED/LCD/PDP TV and monitor Lighting
- Solar/Renewable/UPS-Micro Inverter System
- Charger
- Power Supply

100% Avalanche Tested

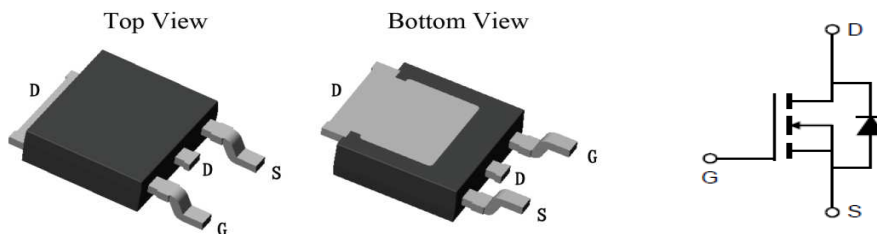
Package Marking and Ordering Information

Part #	Marking	Package	Packing	Reel Size	Tape Width	Qty
CRJD650N65GC	-	TO-252	Tape&Reel	N/A	N/A	2500pcs

Absolute Maximum Ratings

Parameter	Symbol	Value	Unit
Drain-source voltage	V _{DS}	650	V
Continuous drain current T _C = 25°C T _C = 100°C	I _D	7 4.0	A
Pulsed drain current (T _C = 25°C, t _p limited by T _{jmax})	I _{D pulse}	28	A
Avalanche energy, single pulse (L=60mH, R _g =30Ω)	E _{AS}	90	mJ
Gate-Source voltage	V _{GS}	±30	V
Power dissipation (T _C = 25°C)	P _{tot}	133	W
Operating junction and storage temperature	T _j , T _{stg}	-55...+150	°C

Thermal Resistance

Parameter	Symbol	Value	Unit
Thermal resistance, junction – case. Max	R_{thJC}	0.94	°C/W
Thermal resistance, junction – ambient. Max	R_{thJA}	95	

Electrical Characteristic (at $T_j = 25\text{ °C}$, unless otherwise specified)

Parameter	Symbol	Value			Unit	Test Condition
		min.	typ.	max.		

Static Characteristic

Drain-source breakdown voltage	BV_{DSS}	650	-	-	V	$V_{GS}=0V, I_D=250\mu A$
Gate threshold voltage	$V_{GS(th)}$	3.5	4	4.5	V	$V_{DS}=V_{GS}, I_D=250\mu A$
Zero gate voltage drain current	I_{DSS}	-	-	1	μA	$V_{DS}=650V, V_{GS}=0V$ $T_C=25\text{ °C}$ $T_C=150\text{ °C}$
Gate-source leakage current	I_{GSS}	-	0.3	80	nA	$V_{GS}=\pm 30V, V_{DS}=0V$
Drain-source on-state resistance	$R_{DS(on)}$	-	0.6	0.68	Ω	$V_{GS}=10V, I_D=3.5A,$ $T_C=25\text{ °C}$ $T_C=150\text{ °C}$
Transconductance	g_{fs}	-	8.7	-	S	$V_{DS}=20V, I_D=3.5A$

Dynamic Characteristic

Input Capacitance	C_{iss}	-	507	-	pF	$V_{GS}=0V, V_{DS}=100V,$ $f=1MHz$
Output Capacitance	C_{oss}	-	26	-		
Reverse Transfer Capacitance	C_{rss}	-	22	-		
Gate Total Charge	Q_G	-	15	-	nC	$V_{GS}=10V, V_{DS}=480V,$ $I_D=3.5A, f=1MHz$
Gate-Source charge	Q_{gs}	-	3.8	-		
Gate-Drain charge	Q_{gd}	-	6	-		
Turn-on delay time	$t_{d(on)}$	-	18	-	ns	$T_j=25\text{ °C}, V_{GS}=10V,$ $I_D=3.5A, V_{DS}=400V,$ $R_g=25\Omega$
Rise time	t_r	-	12	-		
Turn-off delay time	$t_{d(off)}$	-	48	-		
Fall time	t_f	-	53	-		
Gate resistance	R_G	-	2.5	-	Ω	$V_{GS}=0V, V_{DS}=0V,$ $f=1MHz$

Body Diode Characteristic

Parameter	Symbol	Value			Unit	Test Condition
		min.	typ.	max.		
Body Diode Forward Voltage	V_{SD}	0.5	0.84	1	V	$V_{GS}=0V, I_{SD}=3.5A$
Body Diode Reverse Recovery Time	t_{rr}	-	187	-	ns	$I_{sd}=3.5A$ $dI/dt=100A/us, V_{ds}=100V$
Body Diode Reverse Recovery Charge	Q_{rr}	-	1.59	-	uC	

Typical Performance Characteristics

Fig 1. Output Characteristics (Tj=25°C)

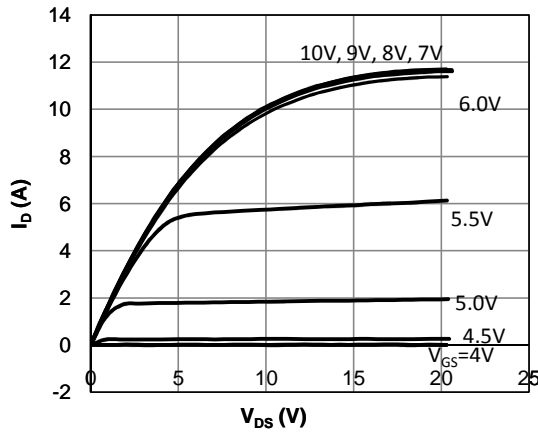

Fig 2. Output Characteristics (Tj=150°C)

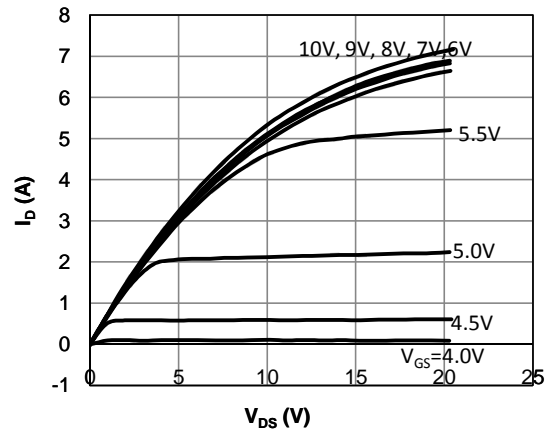

Fig 3: Transfer Characteristics

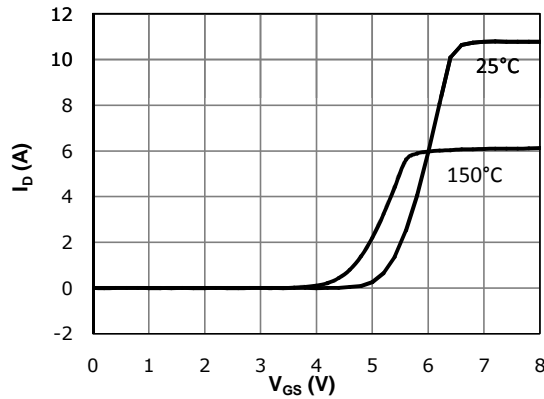

Fig 4: Vth Vs Tj Temperature Characteristics

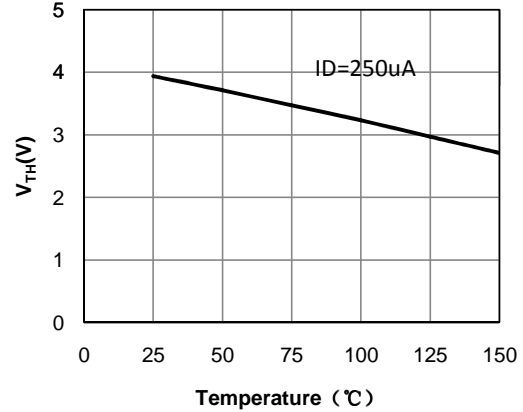

Fig 5: Rds(on) Vs Ids Characteristics(Tc=25°C)

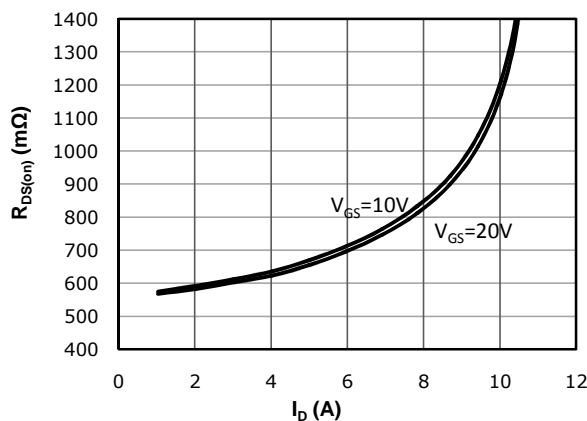

Fig 6: Rds(on) vs. Temperature

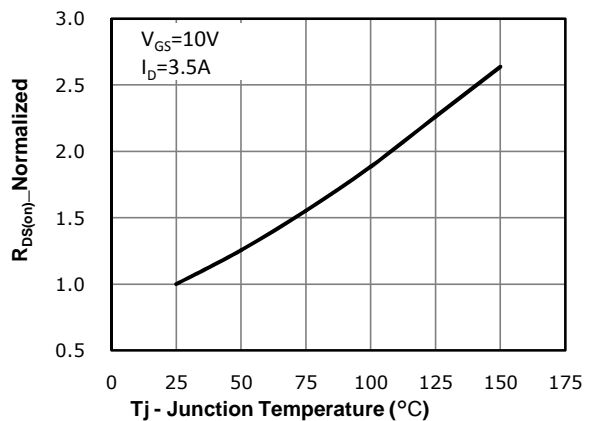

Fig 7: BVdss vs. Temperature

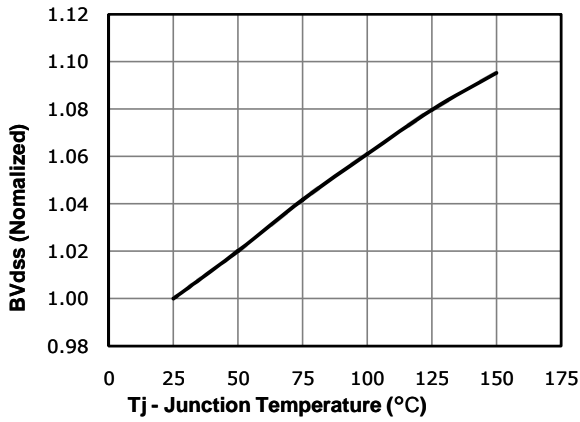

Fig 8: Rds(on) vs Gate Voltage

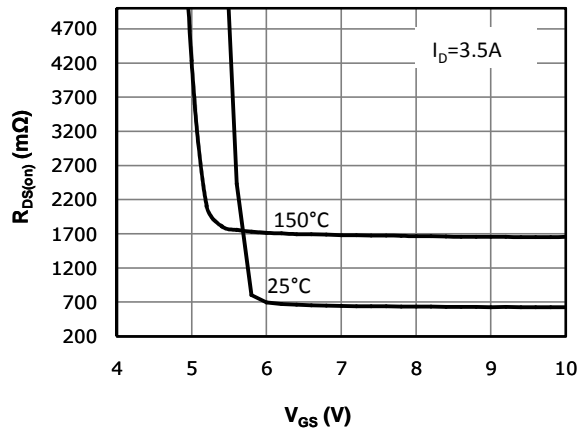

Fig 9: Body-diode Forward Characteristics

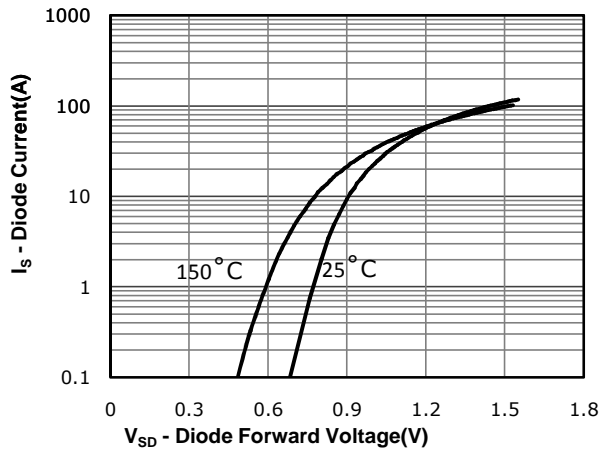

Fig 10: Gate Charge Characteristics

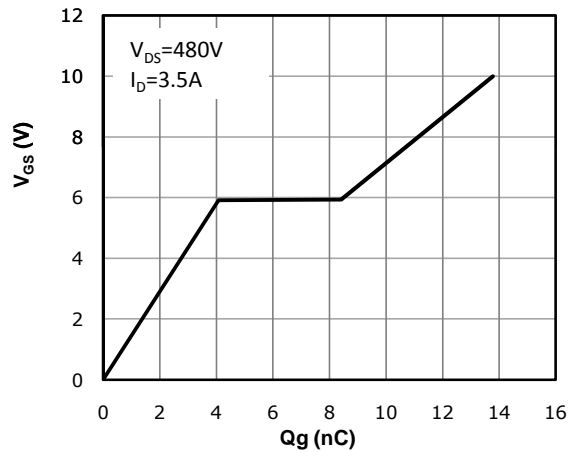

Fig 11: Capacitance Characteristics

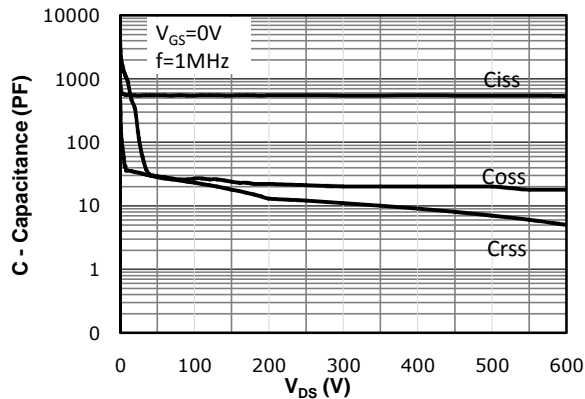

Fig 12: Safe Operating Area

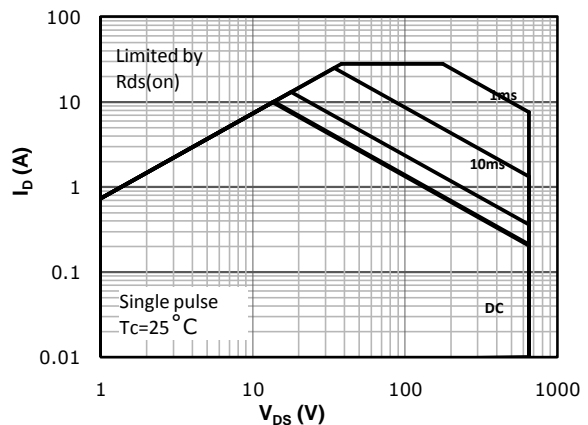
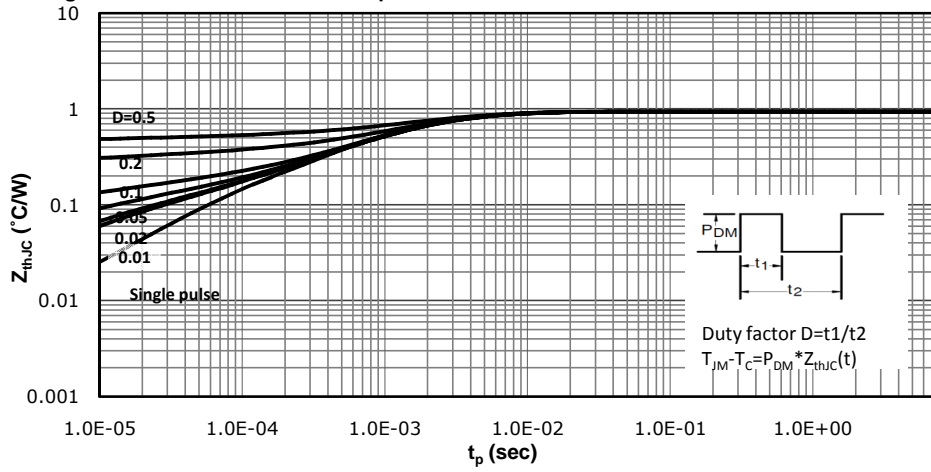
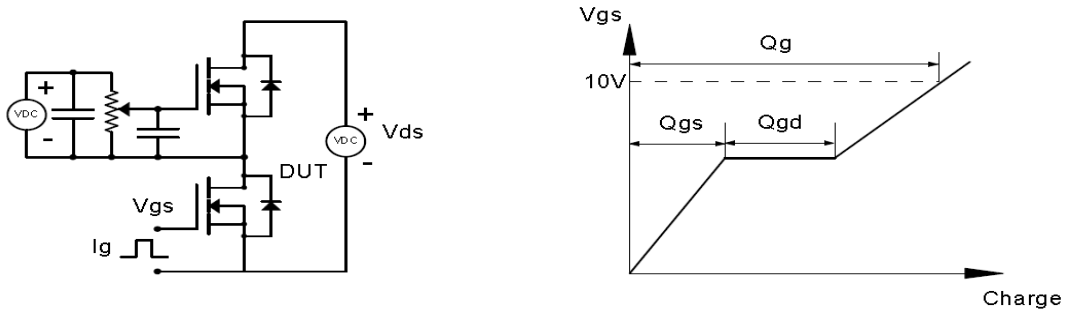

Fig 13: Max. Transient Thermal Impedance



Test Circuit & Waveform

Gate Charge Test Circuit & Waveform



Resistive Switching Test Circuit & Waveforms

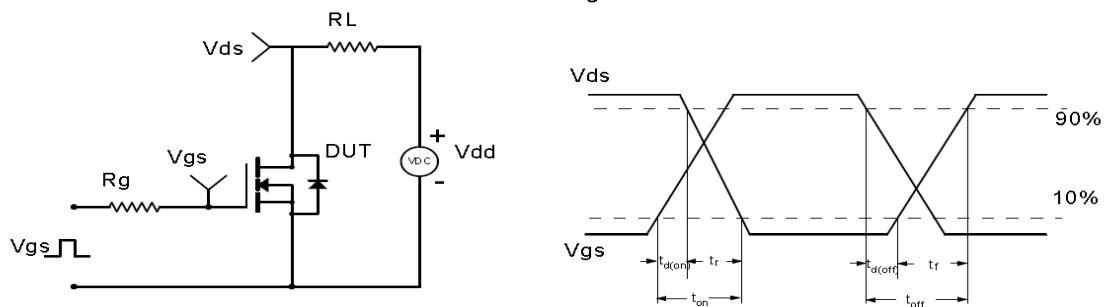

Unclamped Inductive Switching (UIS) Test Circuit & Waveforms

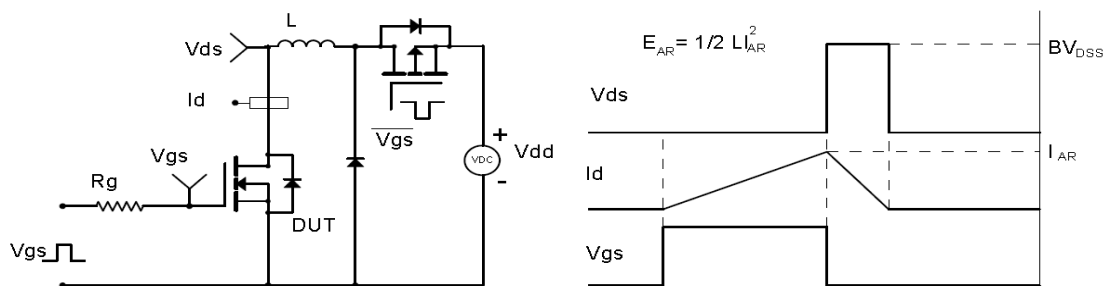

Diode Recovery Test Circuit & Waveforms

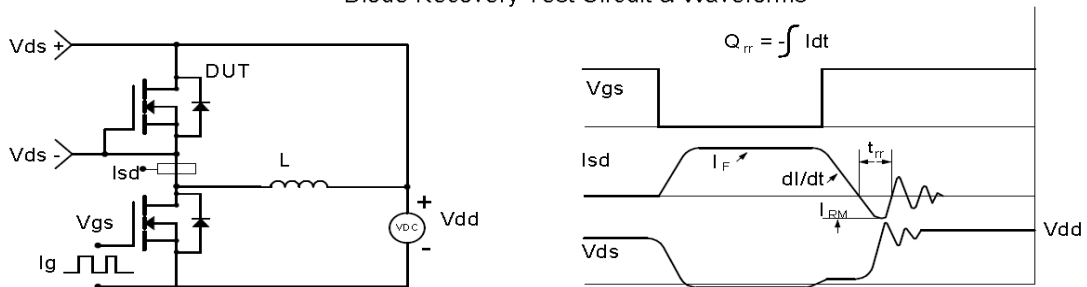

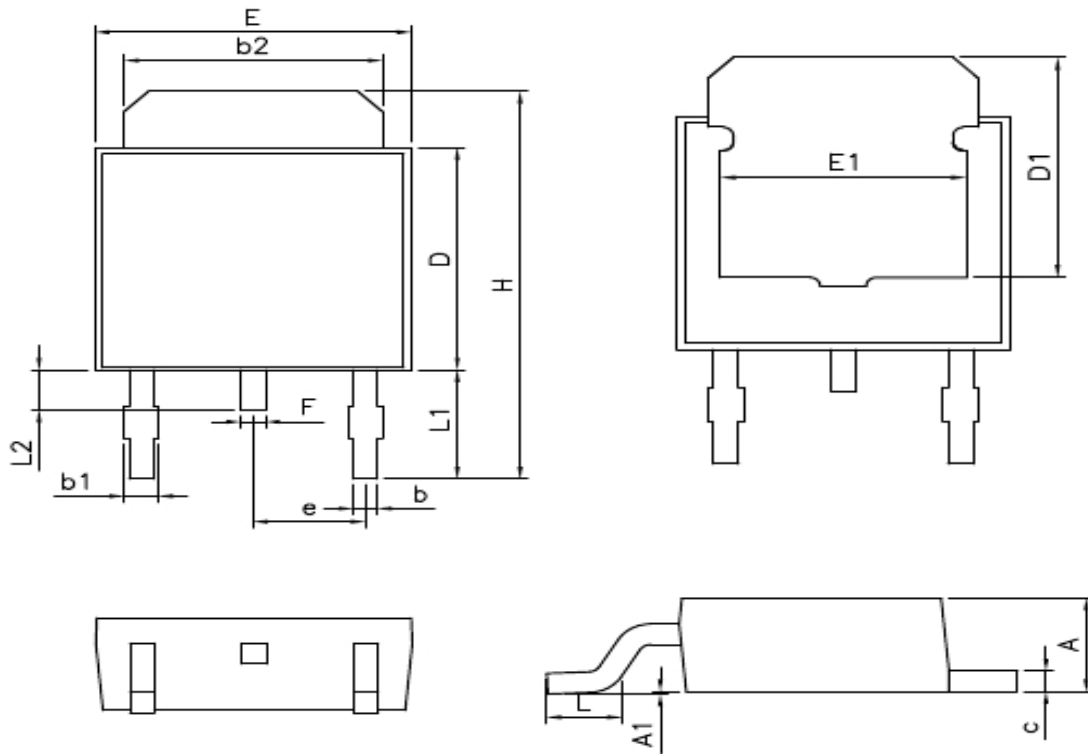
Package Outline: TO-252

Symbol	Dimensions In Millimeters		Dimensions In Inches	
	Min.	Max.	Min.	Max.
A	2.20	2.40	0.087	0.094
A1	0.00	0.15	0.000	0.006
b	0.50	0.70	0.020	0.028
b1	0.60	0.90	0.024	0.035
b2	5.20	5.50	0.205	0.217
c	0.45	0.55	0.018	0.022
D	5.40	5.80	0.213	0.228
D1	4.57	-	0.180	-
e	2.29 BSC.		0.090 BSC.	
E	6.40	6.80	0.252	0.268
E1	3.81	-	0.150	-
F	0.70	0.90	0.028	0.035
H	9.40	10.20	0.370	0.402
L	1.40	1.77	0.055	0.070
L1	2.40	3.00	0.094	0.118
L2	0.80	1.20	0.031	0.047

Revision History

Revision	Date	Major changes
1.0	2019-7-2	Release of formal version

Disclaimer

Unless otherwise specified in the datasheet, the product is designed and qualified as a standard commercial product and is not intended for use in applications that require extraordinary levels of quality and reliability, such as automotive, aviation/aerospace and life-support devices or systems.

Any and all semiconductor products have certain probability to fail or malfunction, which may result in personal injury, death or property damage. Customer are solely responsible for providing adequate safe measures when design their systems.

CRM(CQ) reserves the right to improve product design, function and reliability without notice.

单击下面可查看定价，库存，交付和生命周期等信息

[>>CRMICRO\(华润微\)](#)