

**Features**

- CRM(CQ) Super\_Junction technology
- Much lower Ron\*A performance for On-state efficiency
- Much lower FOM for fast switching efficiency

**Product Summary**

V <sub>DS</sub>	650V
R <sub>DS(on)_typ</sub>	0.39Ω
I <sub>D</sub>	11A

**Applications**

- LED/LCD/PDP TV and monitor Lighting
- Solar/Renewable/UPS-Micro Inverter System
- Charger
- Power Supply

**100% Avalanche Tested**

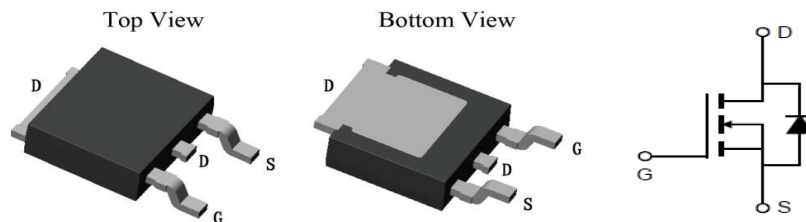
**Package Marking and Ordering Information**

Part #	Marking	Package	Packing	Reel Size	Tape Width	Qty
CRJD390N65GC	-	TO-252	Tape&Reel	N/A	N/A	2500pcs

**Absolute Maximum Ratings**

Parameter	Symbol	Value	Unit
Drain-source voltage	V <sub>DS</sub>	650	V
Continuous drain current T <sub>C</sub> = 25°C T <sub>C</sub> = 100°C	I <sub>D</sub>	11 7.0	A
Pulsed drain current (T <sub>C</sub> = 25°C, t <sub>p</sub> limited by T <sub>jmax</sub> )	I <sub>D pulse</sub>	44	A
Avalanche energy, single pulse (L=60mH, Rg=30Ω)	E <sub>AS</sub>	120	mJ
Gate-Source voltage	V <sub>GS</sub>	±30	V
Power dissipation (T <sub>C</sub> = 25°C)	P <sub>tot</sub>	74	W
Operating junction and storage temperature	T <sub>j</sub> , T <sub>stg</sub>	-55...+150	°C

**Thermal Resistance**

Parameter	Symbol	Value	Unit
Thermal resistance, junction – case. Max	$R_{thJC}$	1.68	°C/W
Thermal resistance, junction – ambient. Max	$R_{thJA}$	73	

**Electrical Characteristic (at  $T_j = 25\text{ °C}$ , unless otherwise specified)**

Parameter	Symbol	Value			Unit	Test Condition
		min.	typ.	max.		

**Static Characteristic**

Drain-source breakdown voltage	$BV_{DSS}$	650	-	-	V	$V_{GS}=0V, I_D=250\mu A$
Gate threshold voltage	$V_{GS(th)}$	3.5	-	4.5	V	$V_{DS}=V_{GS}, I_D=250\mu A$
Zero gate voltage drain current	$I_{DSS}$	-	-	1	$\mu A$	$V_{DS}=650V, V_{GS}=0V$ $T_C=25\text{ °C}$
		-	10	-		$T_C=150\text{ °C}$
Gate-source leakage current	$I_{GSS}$	-	0.3	80	nA	$V_{GS}=\pm 30V, V_{DS}=0V$
Drain-source on-state resistance	$R_{DS(on)}$	-	0.39	0.45	$\Omega$	$V_{GS}=10V, I_D=5.5A,$ $T_C=25\text{ °C}$
		-	1	-		$T_C=150\text{ °C}$
Transconductance	$g_{fs}$	-	12	-	S	$V_{DS}=20V, I_D=5.5A$

**Dynamic Characteristic**

Input Capacitance	$C_{iss}$	-	770	-	pF	$V_{GS}=0V, V_{DS}=100V,$ $f=1MHz$
Output Capacitance	$C_{oss}$	-	32	-		
Reverse Transfer Capacitance	$C_{rss}$	-	23	-		
Gate Total Charge	$Q_G$	-	22	-	nC	$V_{GS}=10V, V_{DS}=480V,$ $I_D=5.5A, f=1MHz$
Gate-Source charge	$Q_{gs}$	-	5.3	-		
Gate-Drain charge	$Q_{gd}$	-	8.8	-		
Turn-on delay time	$t_{d(on)}$	-	20	-	ns	$T_j=25\text{ °C}, V_{GS}=10V,$ $I_D=5.5A, V_{DS}=400V,$ $R_g=25\Omega$
Rise time	$t_r$	-	15	-		
Turn-off delay time	$t_{d(off)}$	-	74	-		
Fall time	$t_f$	-	43	-		
Gate resistance	$R_G$	-	2.0	-	$\Omega$	$V_{GS}=0V, V_{DS}=0V,$ $f=1MHz$

**Body Diode Characteristic**

Parameter	Symbol	Value			Unit	Test Condition
		min.	typ.	max.		
Body Diode Forward Voltage	$V_{SD}$	0.5	0.84	1	V	$V_{GS}=0V, I_{SD}=5.5A$
Body Diode Reverse Recovery Time	$t_{rr}$	-	218	-	ns	$I_{sd}=5.5A$ $dI/dt=100A/\mu s, V_{ds}=10$ $0V$
Body Diode Reverse Recovery Charge	$Q_{rr}$	-	2.35	-	uC	

Typical Performance Characteristics

Fig 1. Output Characteristics (Tj=25°C)

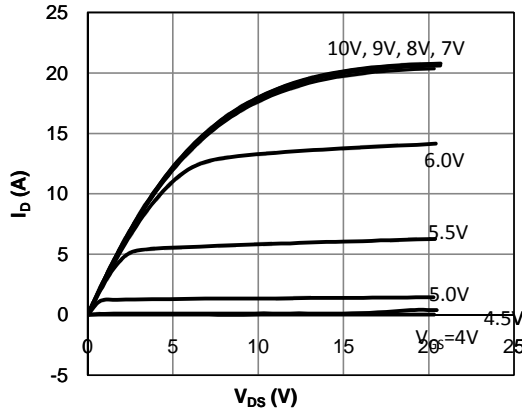

Fig 2. Output Characteristics (Tj=150°C)

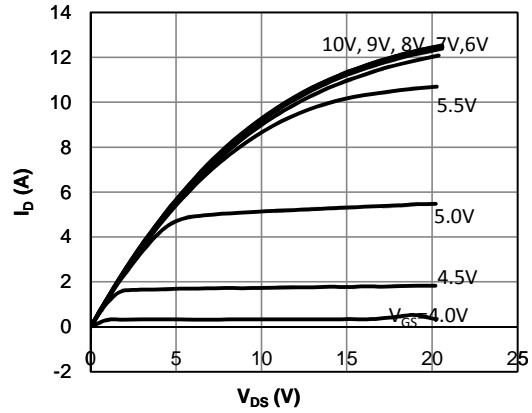

Fig 3: Transfer Characteristics

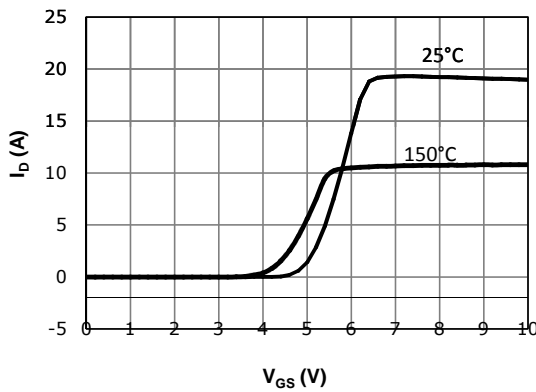

Fig 4:  $V_{TH}$  Vs  $T_j$  Temperature Characteristics

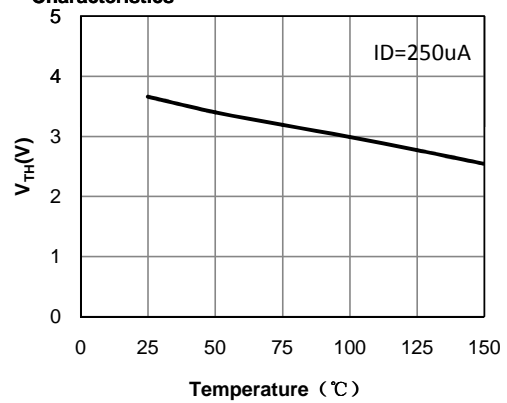

Fig 5:  $R_{dson}$  Vs  $I_{ds}$  Characteristics ( $T_c = 25^\circ\text{C}$ )

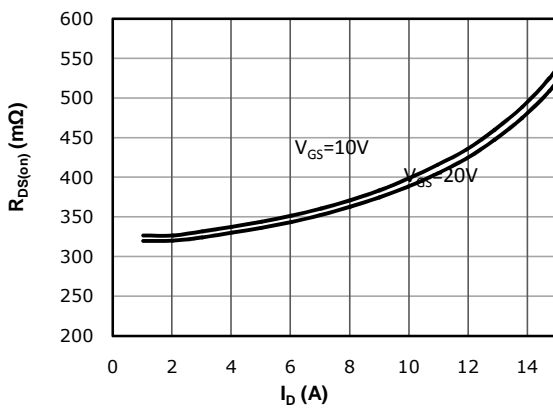

Fig 6:  $R_{ds(on)}$  vs. Temperature

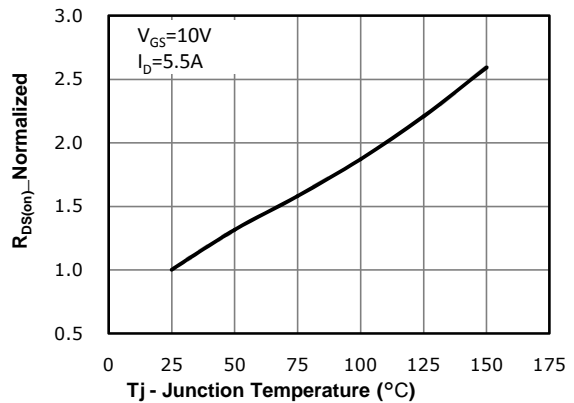

Fig 7: BVdss vs. Temperature

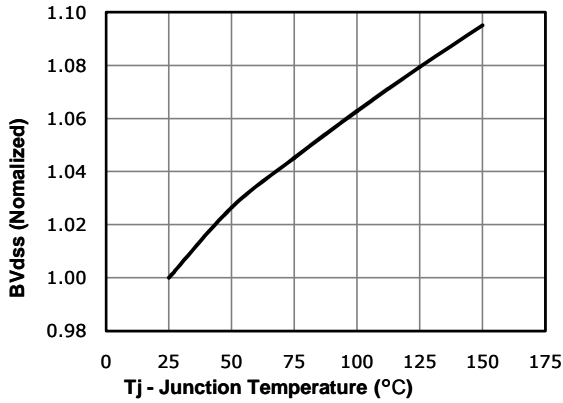

Fig 8: Rds(on) vs Gate Voltage

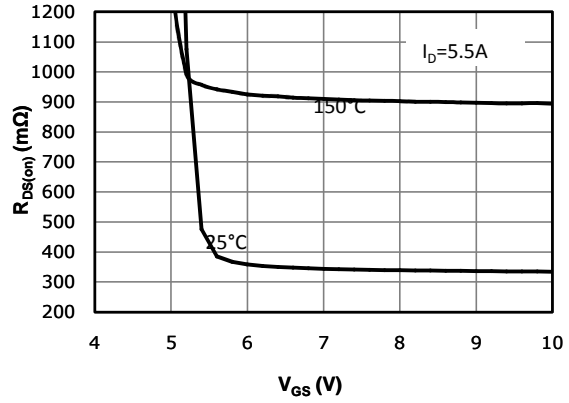

Fig 9: Body-diode Forward Characteristics

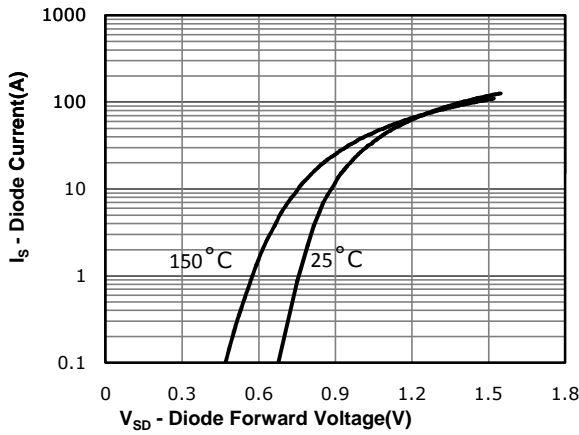

Fig 10: Gate Charge Characteristics

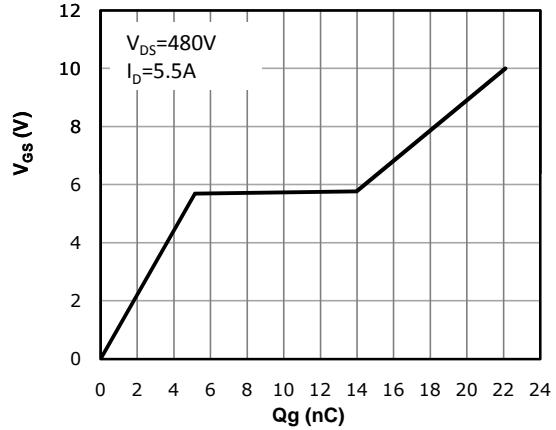

Fig 11: Capacitance Characteristics

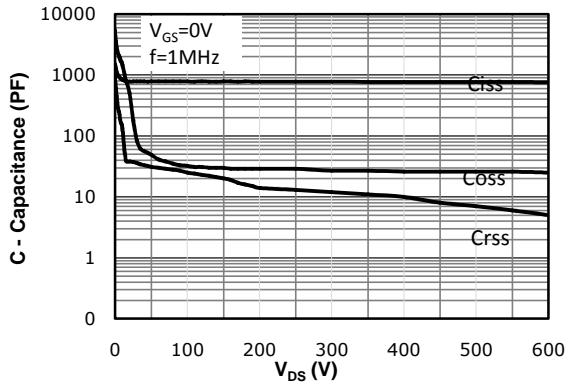

Fig 12: Safe Operating Area

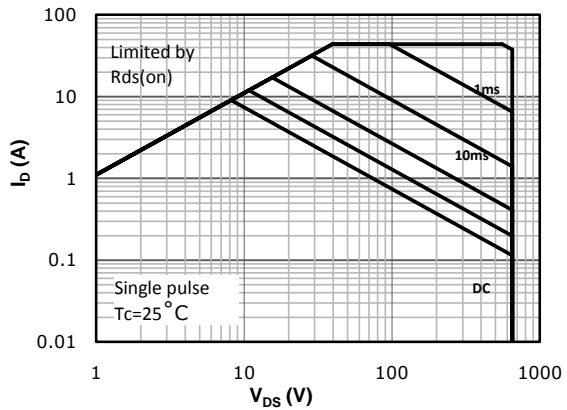
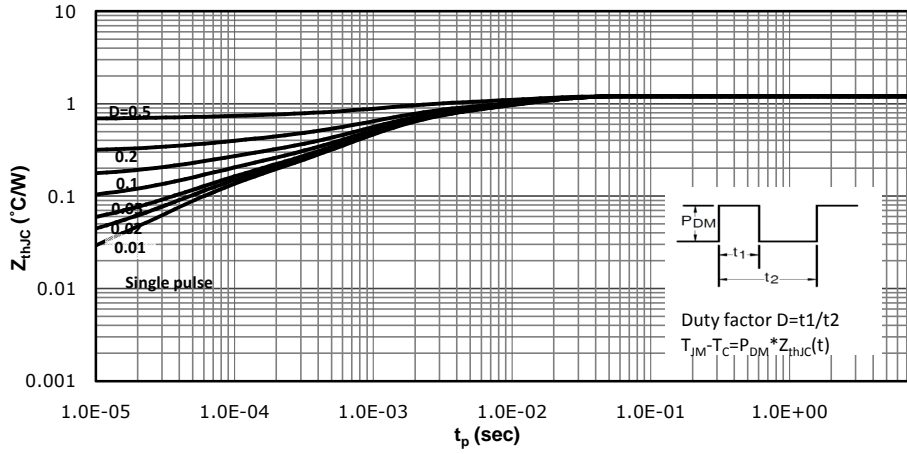
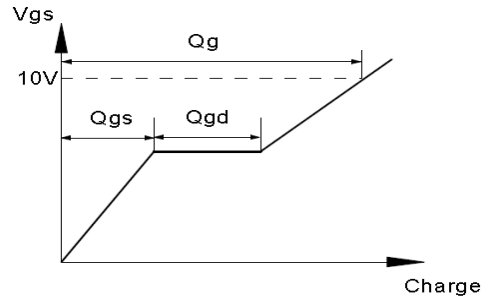
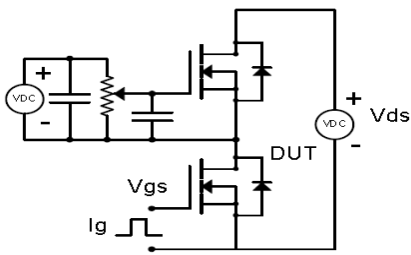

Fig 13: Max. Transient Thermal Impedance



## Test Circuit & Waveform

Gate Charge Test Circuit & Waveform



Resistive Switching Test Circuit & Waveforms

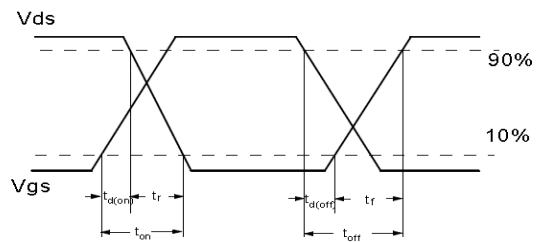
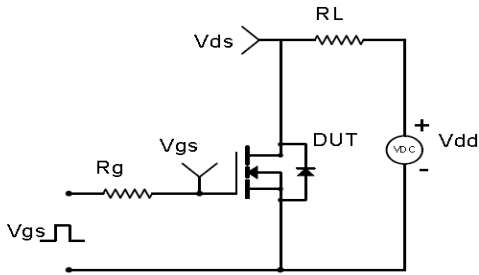

Unclamped Inductive Switching (UIS) Test Circuit & Waveforms

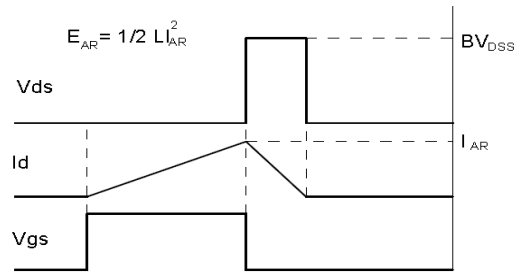
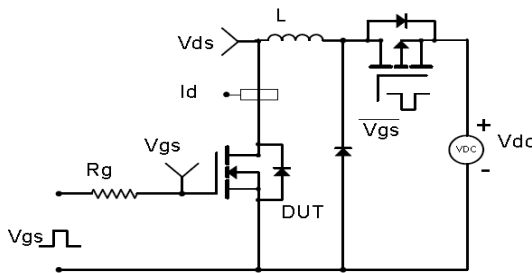

Diode Recovery Test Circuit & Waveforms

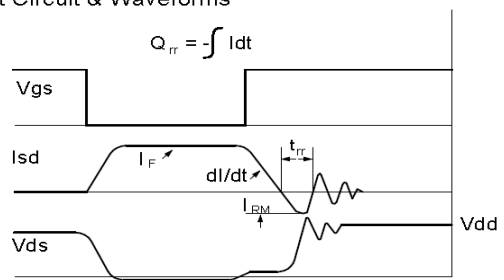
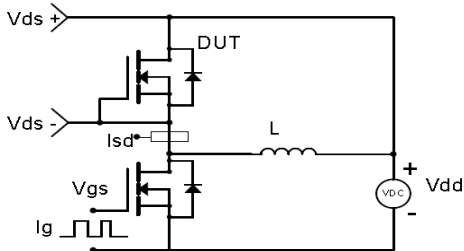

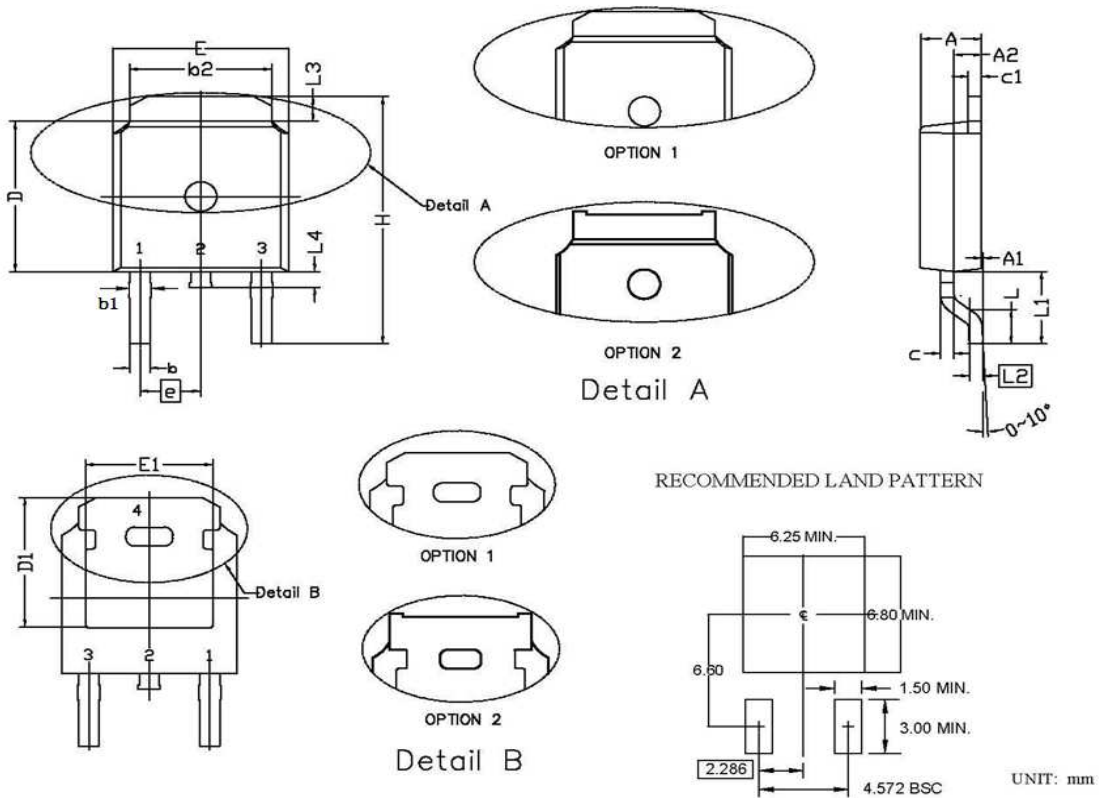
**Package Outline: TO-252**

Symbol	Dimensions In Millimeters		Dimensions In Inches	
	Min.	Max.	Min.	Max.
A	2.15	2.45	0.085	0.096
A1	0.00	0.15	0.000	0.006
A2	0.76	1.36	0.030	0.054
b	0.60	0.91	0.024	0.036
b1	0.65	1.15	0.026	0.045
b2	5.00	5.64	0.197	0.222
c	0.45	0.61	0.018	0.024
c1	0.36	0.66	0.014	0.026
D	5.80	6.30	0.228	0.248
D1	5.00	6.00	0.197	0.236
e	2.29 BSC.		0.090 BSC.	
E	6.30	6.90	0.248	0.272
E1	4.55	5.30	0.179	0.209
H	9.40	10.48	0.370	0.413
L	1.18	1.70	0.046	0.067
L1	2.92 REF		0.115 REF	
L2	0.36	0.66	0.014	0.026
L3	0.72	1.35	0.028	0.053
L4	0.60	1.20	0.024	0.047



**Revision History**

Revision	Date	Major changes
1.0	2019-4-2	Release of formal version

**Disclaimer**

Unless otherwise specified in the datasheet, the product is designed and qualified as a standard commercial product and is not intended for use in applications that require extraordinary levels of quality and reliability, such as automotive, aviation/aerospace and life-support devices or systems.

Any and all semiconductor products have certain probability to fail or malfunction, which may result in personal injury, death or property damage. Customer are solely responsible for providing adequate safe measures when design their systems.

CRM(CQ) reserves the right to improve product design, function and reliability without notice.

单击下面可查看定价，库存，交付和生命周期等信息

[>>CRMICRO\(华润微\)](#)