

**General Description:**

CS3N80 A4R, the silicon N-channel Enhanced VDMOSFETs, is obtained by the self-aligned planar Technology which reduce the conduction loss, improve switching performance and enhance the avalanche energy. The transistor can be used in various power switching circuit for system miniaturization and higher efficiency. The package form is TO-252, which accords with the RoHS standard.

**Features:**

- I **Fast Switching**
- I **Low ON Resistance**( $R_{dson} \leq 4.8\Omega$ )
- I **Low Gate Charge** (Typical Data: 17.3nC)
- I **Low Reverse transfer capacitances**(Typical: 4.3pF)
- I **100% Single Pulse avalanche energy Test**

**Applications:**

Power switch circuit of adaptor and charger.

**Absolute** ( $T_j = 25^\circ\text{C}$  unless otherwise specified):

Symbol	Parameter	Rating	Units
$V_{DSS}$	Drain-to-Source Voltage	800	V
$I_D$	Continuous Drain Current $T_C = 25^\circ\text{C}$	3	A
	Continuous Drain Current $T_C = 100^\circ\text{C}$	1.9	A
$I_{DM}^{a1}$	Pulsed Drain Current $T_C = 25^\circ\text{C}$	12	A
$V_{GS}$	Gate-to-Source Voltage	$\pm 30$	V
$E_{AS}^{a2}$	Single Pulse Avalanche Energy	153	mJ
$dv/dt^{a3}$	Peak Diode Recovery $dv/dt$	5.0	V/ns
$P_D$	Power Dissipation $T_C = 25^\circ\text{C}$	130	W
	Derating Factor above $25^\circ\text{C}$	1.04	W/ $^\circ\text{C}$
$T_J, T_{stg}$	Operating Junction and Storage Temperature Range	150, -55 to 150	$^\circ\text{C}$

$V_{DSS}$	800	V
$I_D$	3	A
$P_D(T_C=25^\circ\text{C})$	130	W
$R_{DS(ON)Typ}$	3.7	$\Omega$

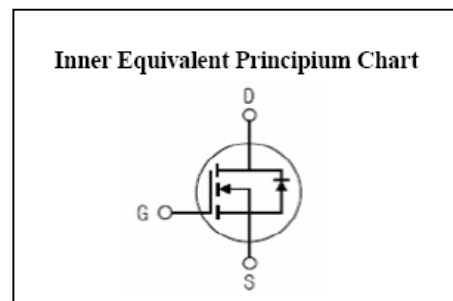
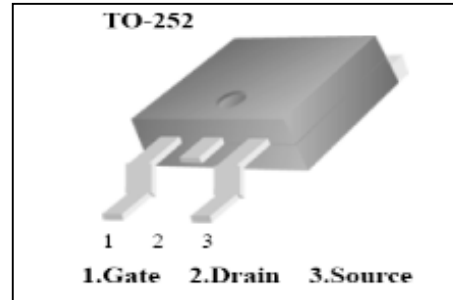

**Electrical Characteristics** (T<sub>j</sub>= 25°C unless otherwise specified):

<b>OFF Characteristics</b>						
Symbol	Parameter	Test Conditions	Rating			Units
			Min.	Typ.	Max.	
V <sub>DSS</sub>	Drain to Source Breakdown Voltage	V <sub>GS</sub> =0V, I <sub>D</sub> =250μA	800	--	--	V
ΔBV <sub>DSS</sub> /ΔT <sub>J</sub>	Bvdss Temperature Coefficient	ID=250uA, Reference 25°C	--	0.9	--	V/°C
I <sub>DSS</sub>	Drain to Source Leakage Current	V <sub>DS</sub> = 800V, V <sub>GS</sub> = 0V, T <sub>j</sub> = 25°C	--	--	25	μA
		V <sub>DS</sub> = 640V, V <sub>GS</sub> = 0V, T <sub>j</sub> = 125°C	--	--	250	μA
I <sub>GSS(F)</sub>	Gate to Source Forward Leakage	V <sub>GS</sub> = +30V	--	--	100	nA
I <sub>GSS(R)</sub>	Gate to Source Reverse Leakage	V <sub>GS</sub> = -30V	--	--	-100	nA

<b>ON Characteristics</b>						
Symbol	Parameter	Test Conditions	Rating			Units
			Min.	Typ.	Max.	
R <sub>DS(ON)</sub>	Drain-to-Source On-Resistance	V <sub>GS</sub> =10V, I <sub>D</sub> =1.5A	--	3.7	4.8	Ω
V <sub>GS(TH)</sub>	Gate Threshold Voltage	V <sub>DS</sub> = V <sub>GS</sub> , I <sub>D</sub> = 250μA	2.0	--	4.0	V
Pulse width tp ≤ 300μs, δ ≤ 2%						

<b>Dynamic Characteristics</b>						
Symbol	Parameter	Test Conditions	Rating			Units
			Min.	Typ.	Max.	
g <sub>fs</sub>	Forward Transconductance	V <sub>DS</sub> =15V, I <sub>D</sub> = 1.5A	--	3.26	--	S
R <sub>g</sub>	Gate resistance	f = 1.0MHz	--	3.0	--	Ω
C <sub>iss</sub>	Input Capacitance	V <sub>GS</sub> = 0V V <sub>DS</sub> = 25V f = 1.0MHz	--	567	--	PF
C <sub>oss</sub>	Output Capacitance		--	48	--	
C <sub>rss</sub>	Reverse Transfer Capacitance		--	4.3	--	

<b>Resistive Switching Characteristics</b>						
Symbol	Parameter	Test Conditions	Rating			Units
			Min.	Typ.	Max.	
t <sub>d(ON)</sub>	Turn-on Delay Time	I <sub>D</sub> = 3.0A V <sub>DD</sub> = 400V V <sub>GS</sub> = 10V R <sub>G</sub> = 10Ω	--	11.6	--	ns
t <sub>r</sub>	Rise Time		--	9.5	--	
t <sub>d(OFF)</sub>	Turn-Off Delay Time		--	22.7	--	
t <sub>f</sub>	Fall Time		--	14	--	
Q <sub>g</sub>	Total Gate Charge	I <sub>D</sub> = 3.0A V <sub>DD</sub> = 640V V <sub>GS</sub> = 10V	--	17.3	--	nC
Q <sub>gs</sub>	Gate to Source Charge		--	2.6	--	
Q <sub>gd</sub>	Gate to Drain ("Miller") Charge		--	9.9	--	

Source-Drain Diode Characteristics						
Symbol	Parameter	Test Conditions	Rating			Units
			Min.	Typ.	Max.	
$I_S$	Continuous Source Current (Body Diode)	$T_C = 25\text{ }^\circ\text{C}$	--	--	3	A
$I_{SM}$	Maximum Pulsed Current (Body Diode)		--	--	12	A
$V_{SD}$	Diode Forward Voltage	$I_S=3.0\text{A}, V_{GS}=0\text{V}$	--	--	1.5	V
$T_{rr}$	Reverse Recovery Time	$I_S=3.0\text{A}, T_j = 25\text{ }^\circ\text{C}$ $dI_F/dt=100\text{A}/\mu\text{s},$ $V_{GS}=0\text{V}$	--	531	--	ns
$Q_{rr}$	Reverse Recovery Charge		--	2370	--	nC
$I_{rrm}$	Reverse Recovery Current		--	8.9	--	A
Pulse width $t_p \leq 300\mu\text{s}, \delta \leq 2\%$						

Symbol	Parameter	Max.	Units
$R_{\theta JC}$	Junction-to-Case	0.95	$^\circ\text{C}/\text{W}$
$R_{\theta JA}$	Junction-to-Ambient	100	$^\circ\text{C}/\text{W}$

<sup>a1</sup>: Repetitive rating; pulse width limited by maximum junction temperature

<sup>a2</sup>:  $L=10\text{mH}, I_D=5.5\text{A}, \text{Start } T_j=25\text{ }^\circ\text{C}$

<sup>a3</sup>:  $I_{SD}=3\text{A}, di/dt \leq 100\text{A}/\mu\text{s}, V_{DD} \leq BV_{DS}, \text{Start } T_j=25\text{ }^\circ\text{C}$

<sup>a4</sup>: Recommend soldering temperature defined by IPC/JEDEC J-STD 020

Characteristics Curve:

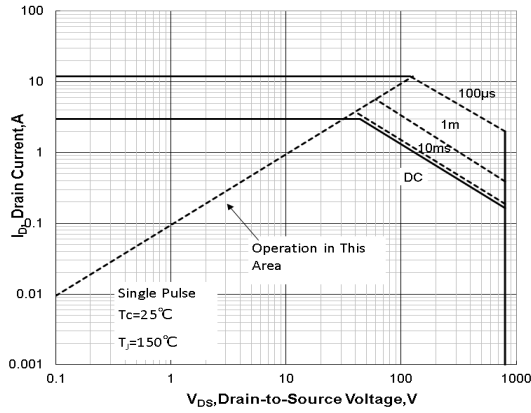

Figure 1 Maximum Forward Bias Safe Operating Area

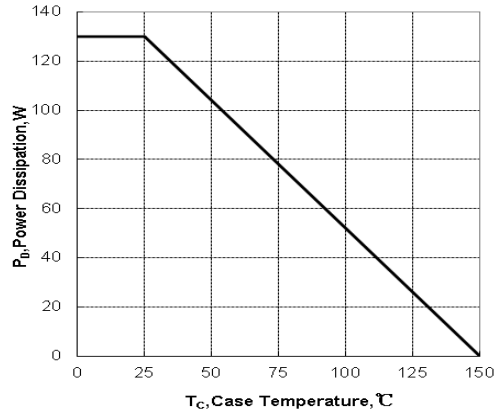

Figure 2 Maximum Power dissipation vs Case Temperature

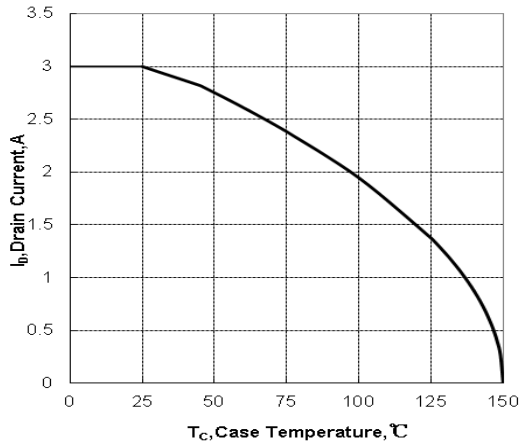

Figure 3 Maximum Continuous Drain Current vs Case Temperature

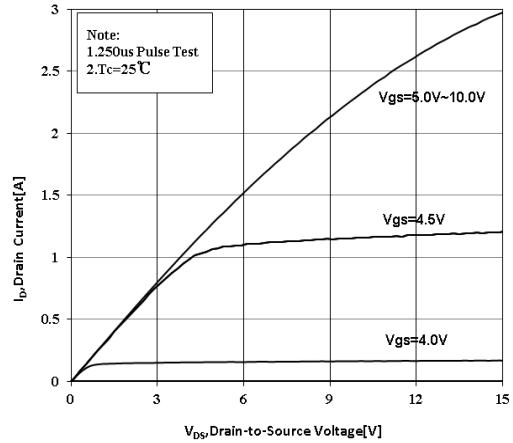

Figure 4 Typical Output Characteristics

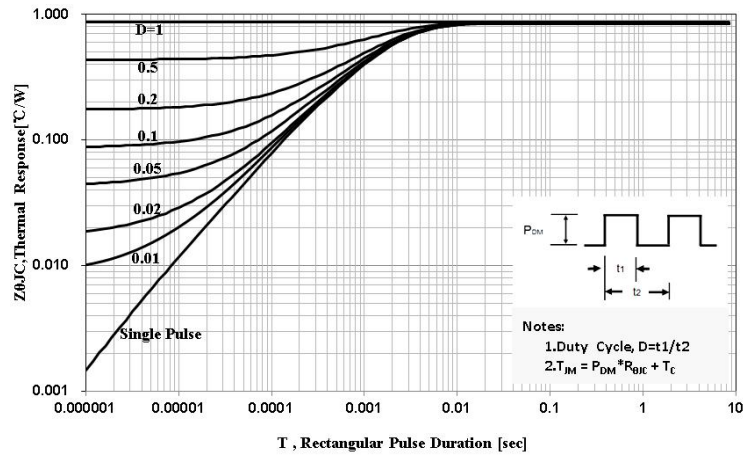

Figure 5 Maximum Effective Thermal Impedance , Junction to Case

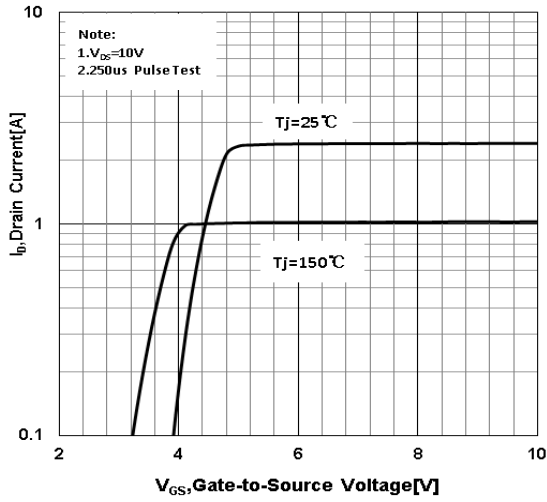

Figure 6 Typical Transfer Characteristics

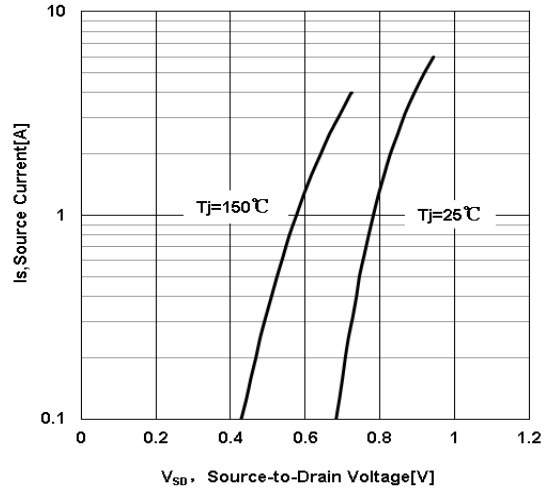

Figure 7 Typical Body Diode Transfer Characteristics

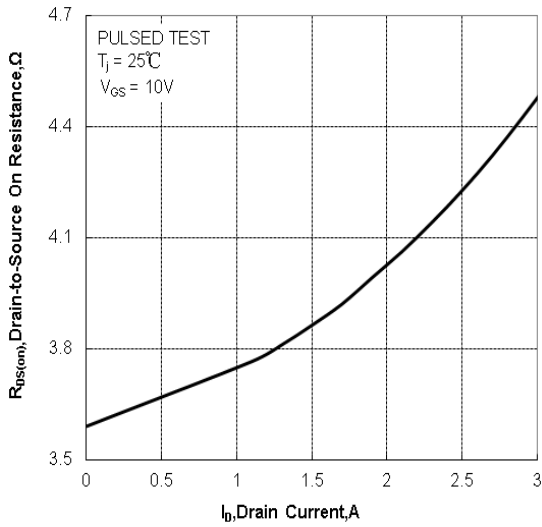

Figure 8 Typical Drain to Source ON Resistance vs Drain Current

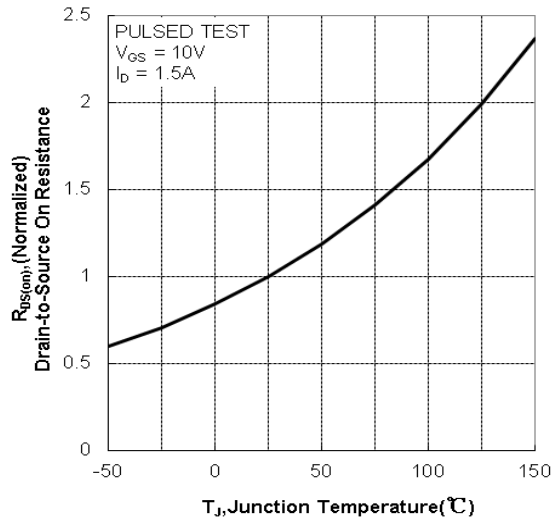

Figure 9 Typical Drain to Source on Resistance vs Junction Temperature

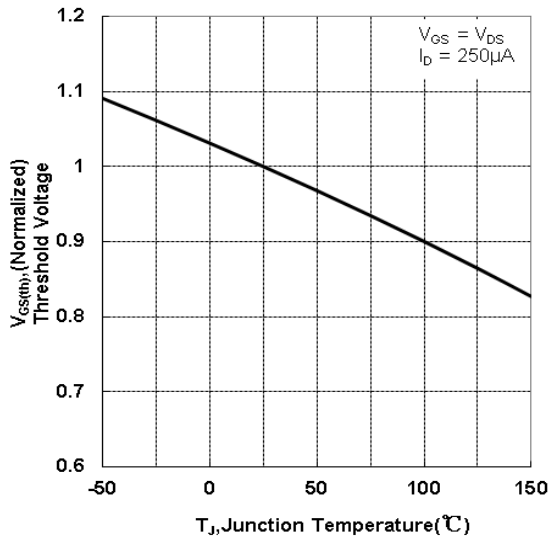

Figure 10 Typical Theshold Voltage vs Junction Temperature

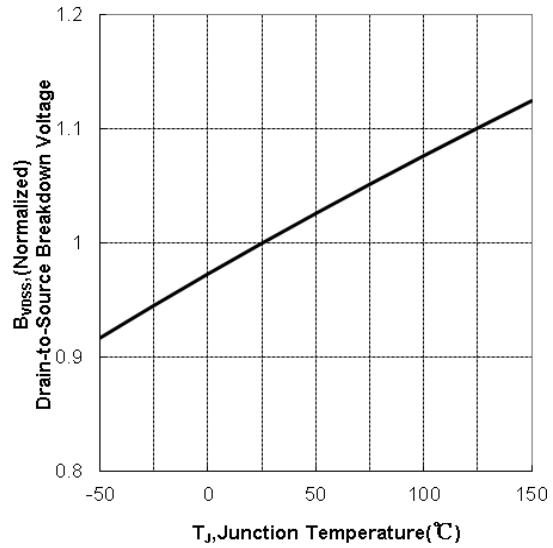

Figure 11 Typical Breakdown Voltage vs Junction Temperature

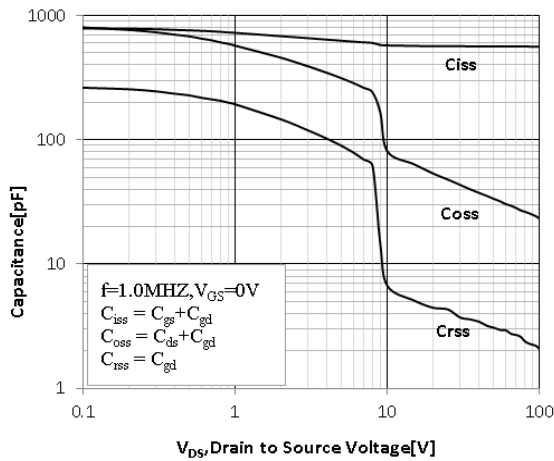

Figure 12 Typical Capacitance vs Drain to Source Voltage

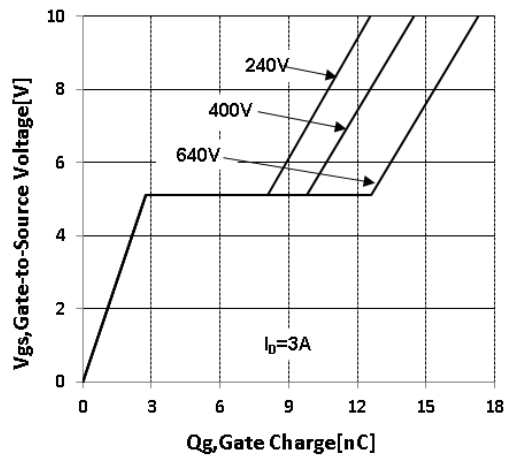

Figure 13 Typical Gate Charge vs Gate to Source Voltage

**Test Circuit and Waveform**



Figure 14. Gate Charge Test Circuit

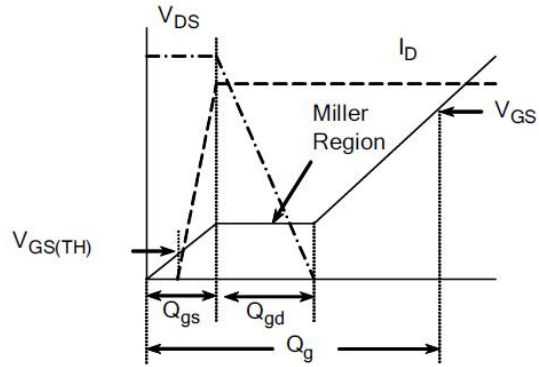

Figure 15. Gate Charge Waveforms



Figure 16. Resistive Switching Test Circuit

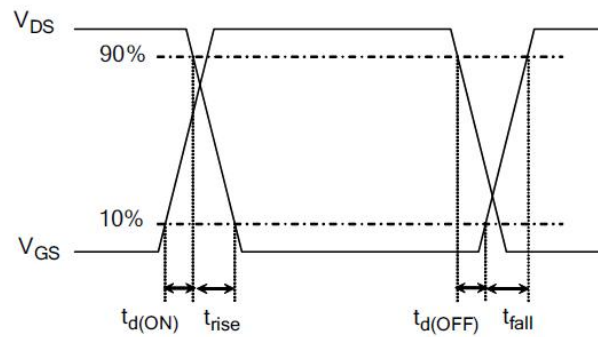

Figure 17. Resistive Switching Waveforms

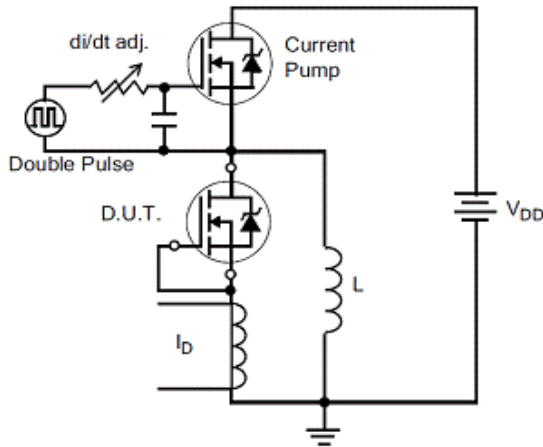

Figure 18. Diode Reverse Recovery Test Circuit

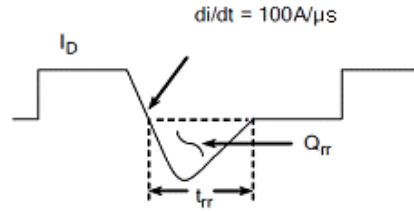

Figure 19. Diode Reverse Recovery Waveform

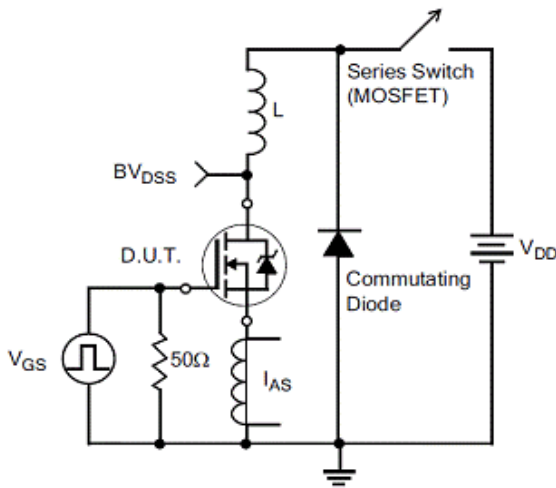

Figure 20. Unclamped Inductive Switching Test Circuit

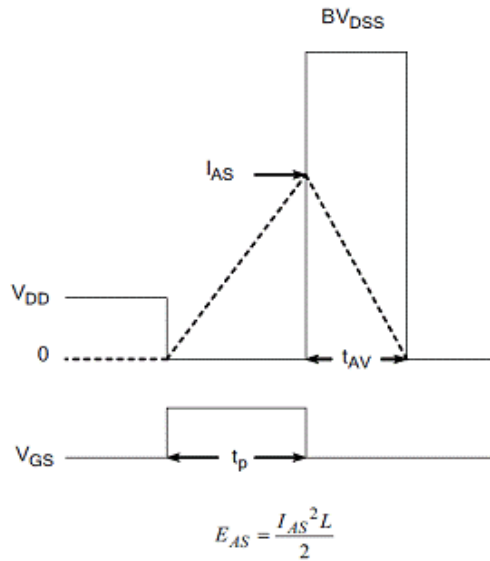
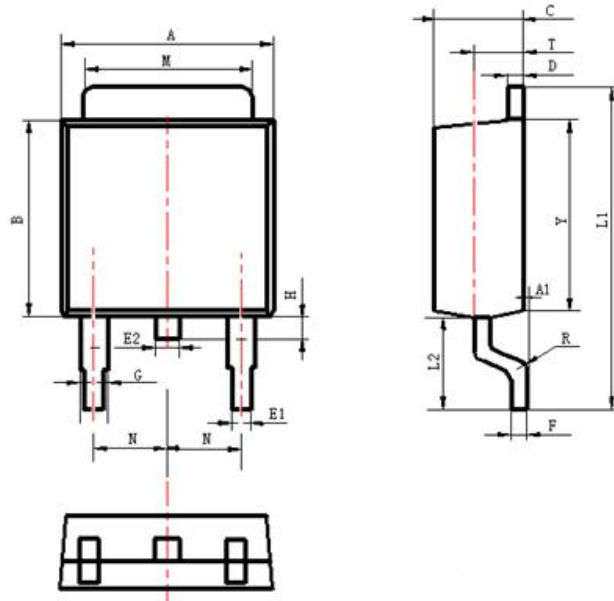

Figure 21. Unclamped Inductive Switching Waveform



**Package Information:**



Items	Values(mm)	
	MIN	MAX
A	6.30	6.90
A1	0	0.16
B	5.70	6.30
C	2.10	2.50
D	0.30	0.70
E1	0.60	0.90
E2	0.70	1.00
F	0.30	0.60
G	0.70	1.20
L1	9.60	10.50
L2	2.70	3.10
H	0.40	1.00
M	5.10	5.50
N	2.09	2.49
R	0.3	
T	1.40	1.60
Y	5.10	6.30

TO-252 Package

**The name and content of poisonous and harmful material in products**

Part's Name	Hazardous Substance									
	Pb	Hg	Cd	Cr(VI)	PBB	PBDE	DI BP	DEHP	DBP	BBP
Limit	≤ 0.1%	≤ 0.1%	≤ 0.01%	≤0.1%	≤0.1%	≤0.1%	≤0.1%	≤0.1%	≤0.1%	≤0.1%
Lead Frame	○	○	○	○	○	○	○	○	○	○
Molding	○	○	○	○	○	○	○	○	○	○
Chip	○	○	○	○	○	○	○	○	○	○
Wire Bonding	○	○	○	○	○	○	○	○	○	○
Solder	×	○	○	○	○	○	○	○	○	○
Note	○: Means the hazardous material is under the criterion of 2011/65/EU. ×: Means the hazardous material exceeds the criterion of 2011/65/EU. The plumbum element of solder exist in products presently, but within the allowed range of Eurogroup's RoHS.									

**Warnings**

1. Exceeding the maximum ratings of the device in performance may cause damage to the device, even the permanent failure, which may affect the dependability of the machine. It is suggested to be used under 80 percent of the maximum ratings of the device.
2. When installing the heatsink, please pay attention to the torsional moment and the smoothness of the heatsink.
3. VDMOSFETs is the device which is sensitive to the static electricity, it is necessary to protect the device from being damaged by the static electricity when using it.
4. This publication is made by Huajing Microelectronics and subject to regular change without notice.

**WUXI CHINA RESOURCES HUAJING MICROELECTRONICS CO., LTD.**

**Add:** No.14 Liangxi RD. Wuxi, Jiangsu, China    **Mail:**214061    <http://www.crhj.com.cn>  
**Tel:** +86 0510-85807228    **Fax:** +86- 0510-85800864

**Marketing Part:**                      **Post:** 214061                      **Tel:** +86 0510-81805277/81805336  
**Fax:** +86 0510-85800360/85803016

**Application and Service: Post: 214061 Tel / Fax: +86- 0510-81805243/81805110**

单击下面可查看定价，库存，交付和生命周期等信息

[>>CRMICRO\(华润微\)](#)