

Features

- Uses CRM(CQ) advanced SkyMOS3 technology
- Extremely low on-resistance $R_{DS(on)}$
- Excellent $Q_g \times R_{DS(on)}$ product(FOM)
- Qualified according to JEDEC criteria

Applications

- Motor control and drive
- Battery management System
- UPS (Uninterruptible Power Supplies)

Product Summary

V_{DS}	150V
$R_{DS(on).typ}$	3.8mΩ
I_D	185A

100% DVDS Tested
100% Avalanche Tested

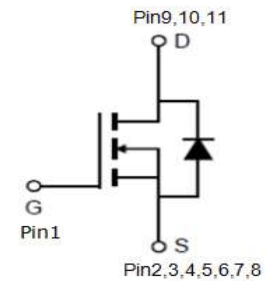

CRSZ043N15N3Z

Package Marking and Ordering Information

Part #	Marking	Package	Packing	Reel Size	Tape Width	Qty
CRSZ043N15N3Z	CRSZ043N15N3Z	TOLL	Tape&Reel	N/A	N/A	2000pcs

Absolute Maximum Ratings

Parameter	Symbol	Value	Unit
Drain-source voltage	V_{DS}	150	V
Continuous drain current $T_C = 25^\circ\text{C}$ (Silicon limit) $T_C = 25^\circ\text{C}$ (Package limit) $T_C = 100^\circ\text{C}$ (Silicon limit)	I_D	185 300 117	A
Pulsed drain current ($T_C = 25^\circ\text{C}$, t_p limited by T_{jmax})	$I_{D\ pulse}$	740	A
Avalanche energy, single pulse ($I_D = 74\text{A}$, $R_g = 25\Omega$) ^[1]	E_{AS}	1367	mJ
Gate-Source voltage	V_{GS}	±20	V
Power dissipation ($T_C = 25^\circ\text{C}$)	P_{tot}	257	W
Operating junction and storage temperature	T_j, T_{stg}	-55...+150	°C

※. Notes:

1.EAS is tested at starting $T_j = 25^\circ\text{C}$, $L = 0.5\text{mH}$, $I_{AS} = 74\text{A}$, $V_{GS} = 10\text{V}$.

Thermal Resistance

Parameter	Symbol	Max	Unit
Thermal resistance, junction – case.	R_{thJC}	0.49	°C/W
Thermal resistance, junction – ambient(min. footprint)	R_{thJA}	62	

Electrical Characteristic (at $T_j = 25\text{ }^\circ\text{C}$, unless otherwise specified)

Parameter	Symbol	Value			Unit	Test Condition
		min.	typ.	max.		

Static Characteristic

Drain-source breakdown voltage	BV_{DSS}	150	-	-	V	$V_{GS}=0V, I_D=250\mu A$
		150	-	-	V	$V_{GS}=0V, I_D=1mA$
Gate threshold voltage	$V_{GS(th)}$	2.0	3.0	4.0	V	$V_{DS}=V_{GS}, I_D=250\mu A$
Zero gate voltage drain current	I_{DSS}	-	-	1	μA	$V_{DS}=150V, V_{GS}=0V$ $T_j=25^\circ C$ $T_j=125^\circ C$
		-	-	100		
Gate-source leakage current	I_{GSS}	0	-	± 100	nA	$V_{GS}=\pm 20V, V_{DS}=0V$
Drain-source on-state resistance	$R_{DS(on)}$	-	3.8	4.3	mΩ	$V_{GS}=10V, I_D=90A$
Transconductance	g_{fs}	67.95	135.9	271.8	S	$V_{DS}=5V, I_D=90A$

Dynamic Characteristic

Input Capacitance	C_{iss}	3338	5007	7510.5	pF	$V_{GS}=0V, V_{DS}=75V,$ $f=1MHz$
Output Capacitance	C_{oss}	539	809	1213.5		
Reverse Transfer Capacitance	C_{rss}	12	23	46		
Gate Total Charge	Q_G	50	75.3	113.0	nC	$V_{GS}=10V, V_{DS}=75V,$ $I_D=90A$
Gate-Source charge	Q_{gs}	20	29.6	44.4		
Gate-Drain charge	Q_{gd}	8	16.8	33.6		
Turn-on delay time	$t_{d(on)}$	-	22.3	-	ns	$V_{GS}=10V, V_{DD}=75V,$ $R_{G_ext}=2.7\Omega$
Rise time	t_r	-	60.2	-		
Turn-off delay time	$t_{d(off)}$	-	58.6	-		
Fall time	t_f	-	28.1	-		
Gate resistance	R_G	-	4.0	-	Ω	$V_{GS}=0V, V_{DS}=0V,$ $f=1MHz$

Body Diode Characteristic

Parameter	Symbol	Value			Unit	Test Condition
		min.	typ.	max.		
Body Diode Forward Voltage	V_{SD}	-	0.85	1.4	V	$V_{GS}=0V, I_{SD}=90A$
Body Diode Reverse Recovery Time	t_{rr}	-	99.6	-	ns	$I_F=90A, dI/dt=100A/\mu s$
Body Diode Reverse Recovery Charge	Q_{rr}	-	323.3	-	nC	

Typical Performance Characteristics

Fig 1: Output Characteristics

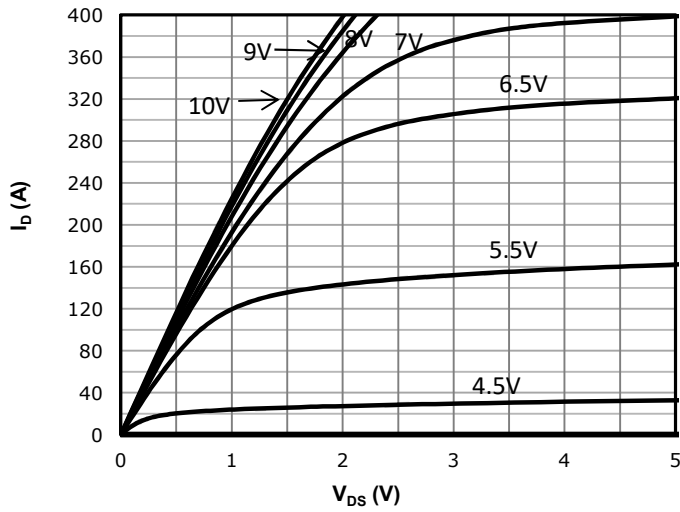

Fig 2: Transfer Characteristics

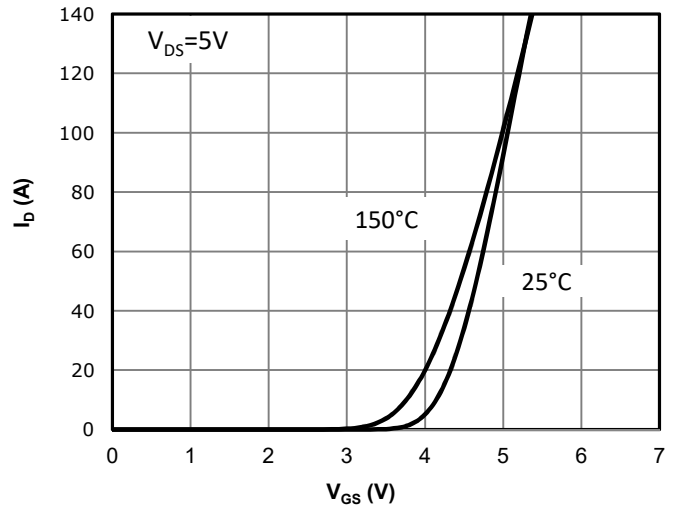
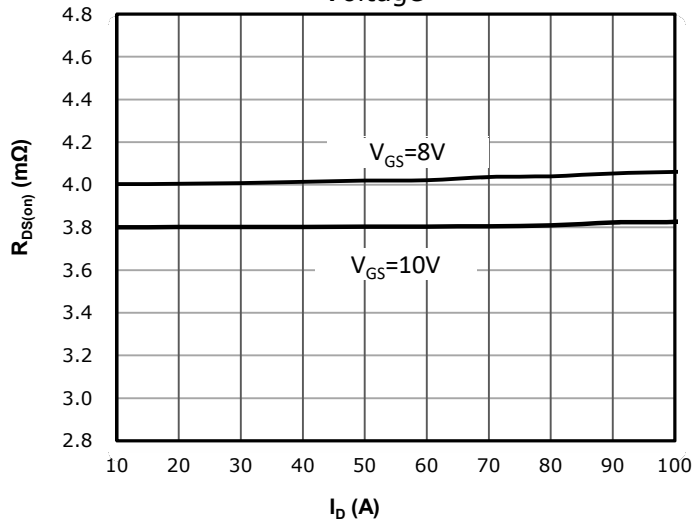
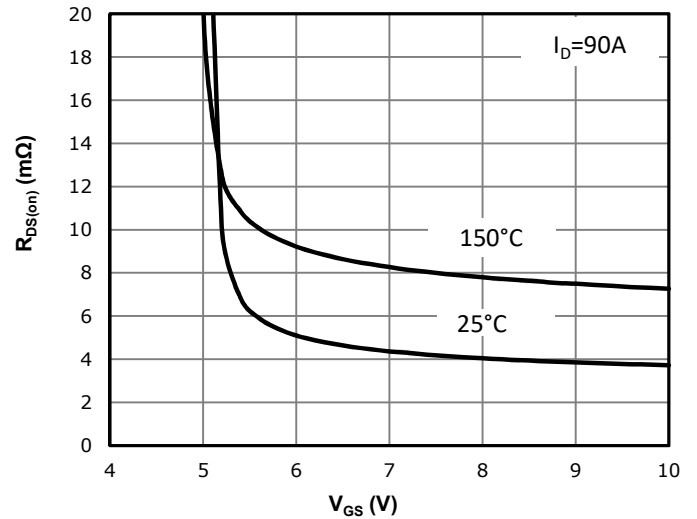
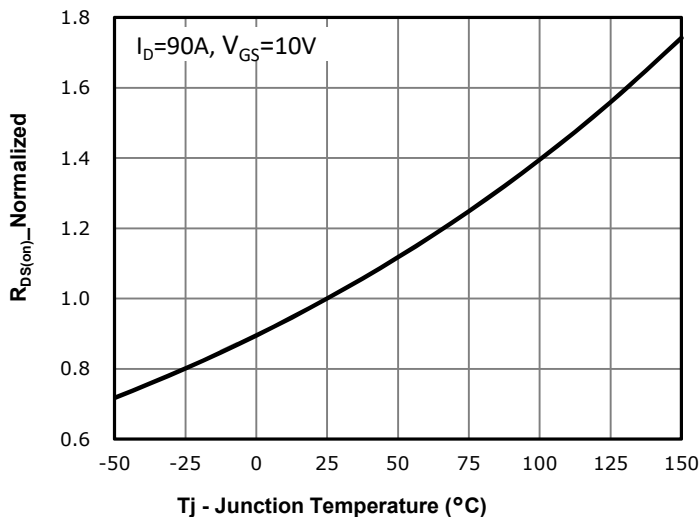
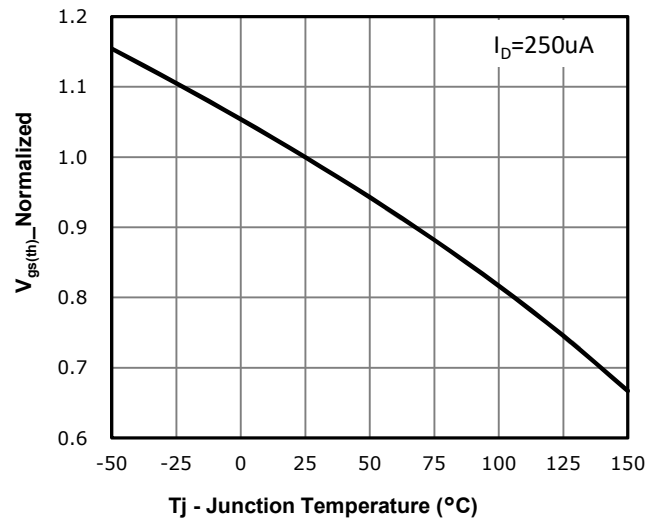

 Fig 3: $R_{DS(on)}$ vs Drain Current and Gate Voltage

 Fig 4: $R_{DS(on)}$ vs Gate Voltage

 Fig 5: $R_{DS(on)}$ vs. Temperature

 Fig 6: $V_{GS(th)}$ vs. Temperature

Fig 7: BVdss vs. Temperature

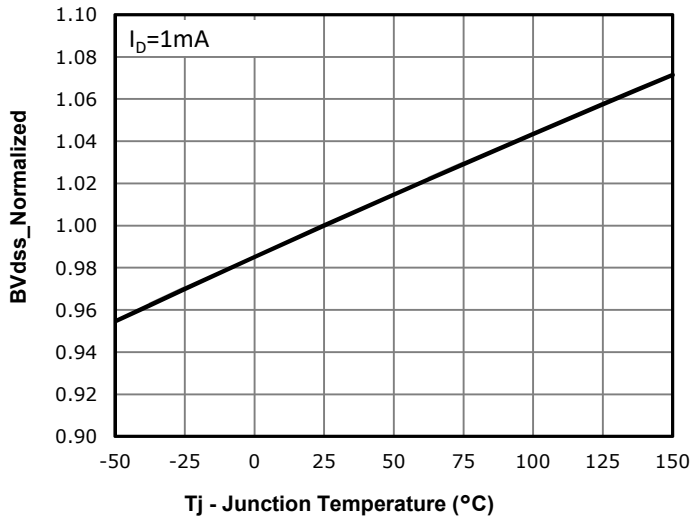

Fig 8: Capacitance Characteristics

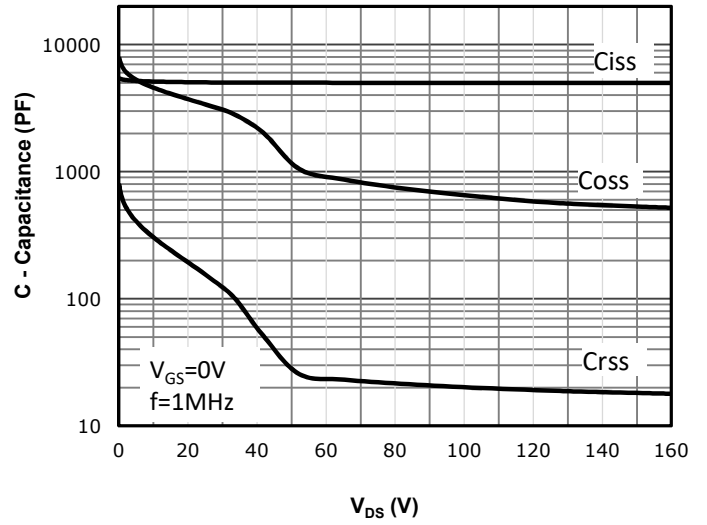

Fig 9: Gate Charge Characteristics

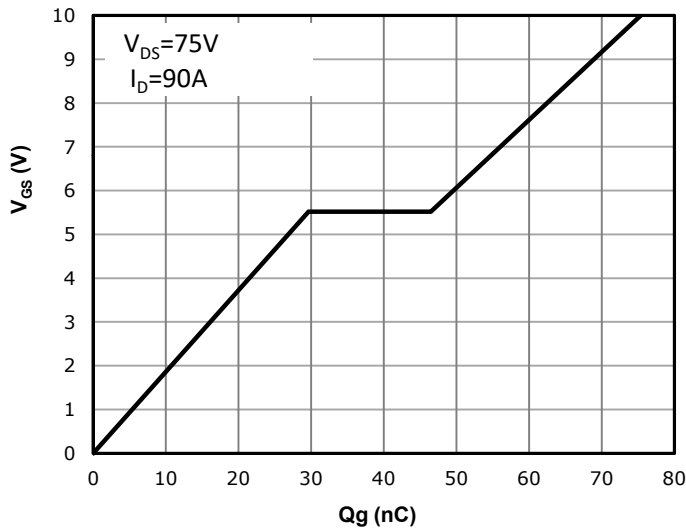

Fig 10: Body-diode Forward Characteristics

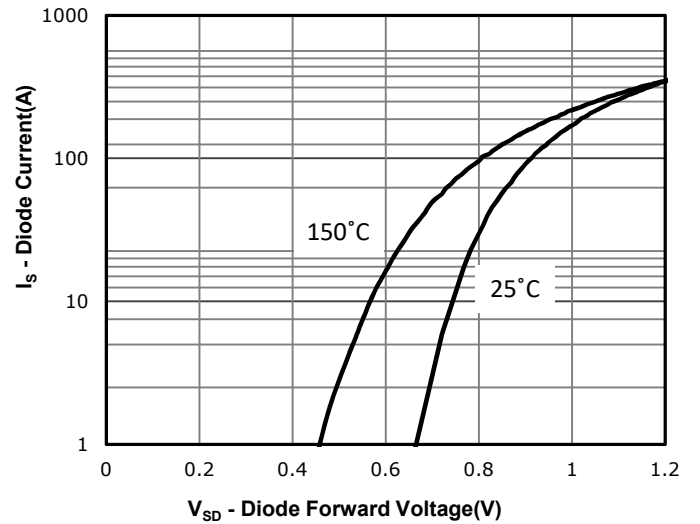

Fig 11: Power Dissipation

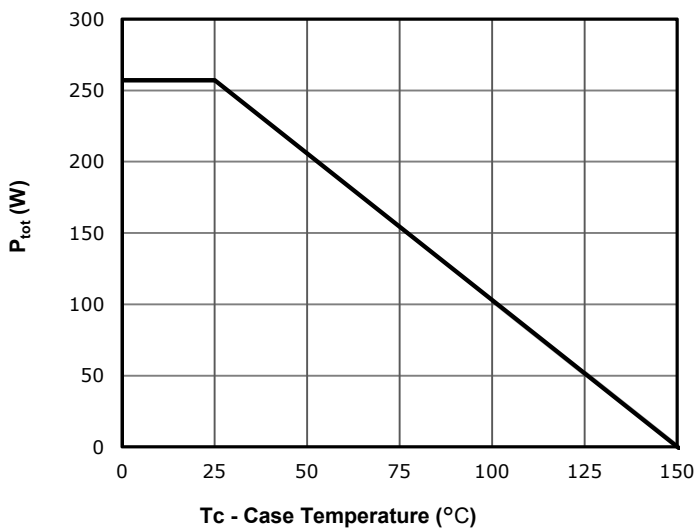

Fig 12: Drain Current Derating

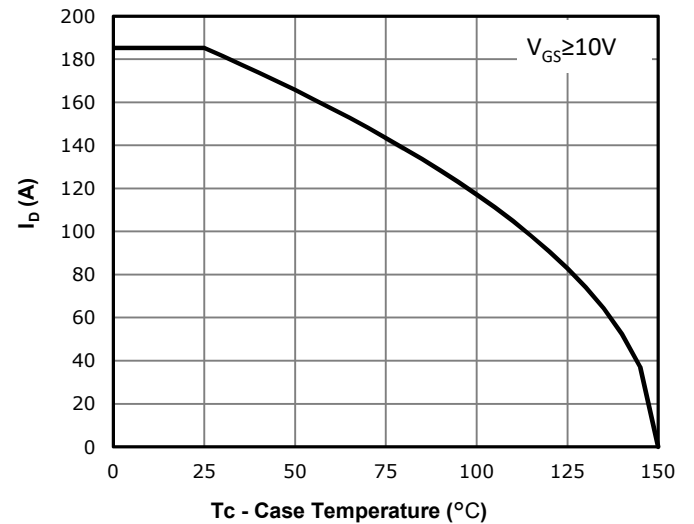

Fig 13: Safe Operating Area

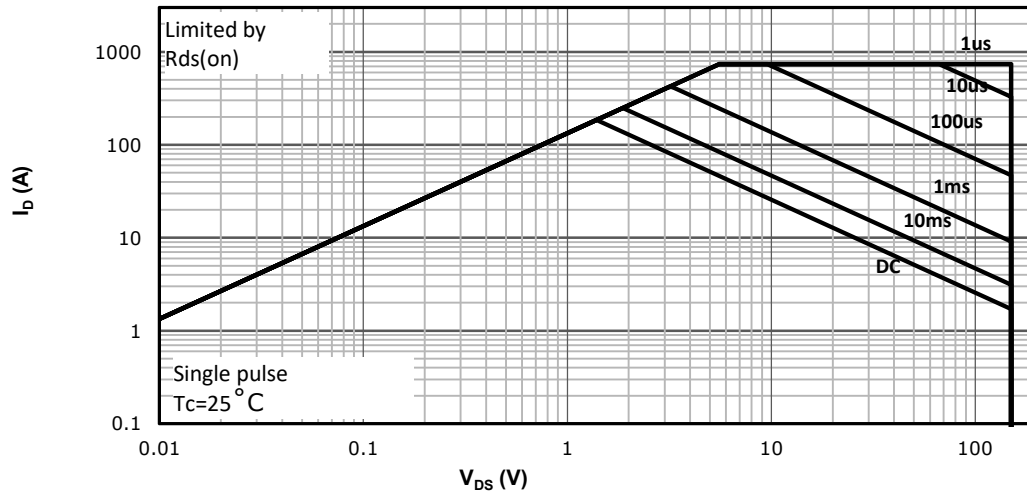
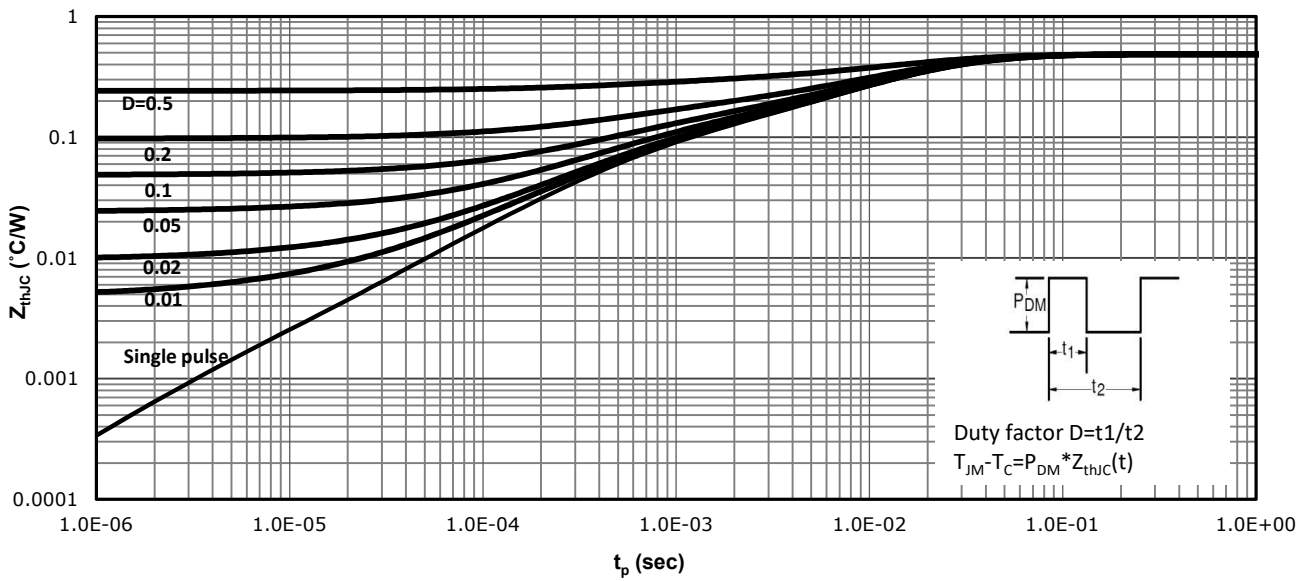
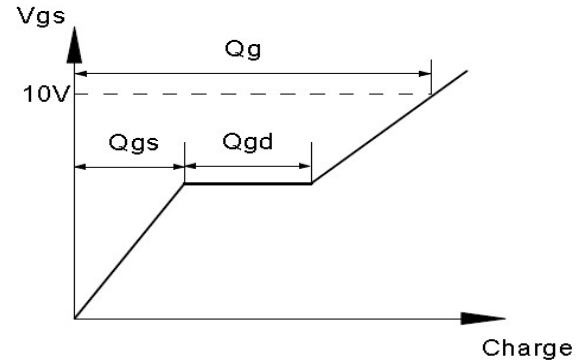
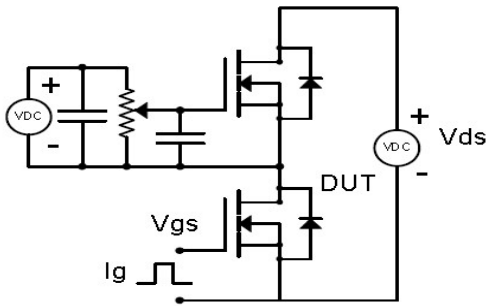

Fig 14: Max. Transient Thermal Impedance



Test Circuit & Waveform

Gate Charge Test Circuit & Waveform



Resistive Switching Test Circuit & Waveforms

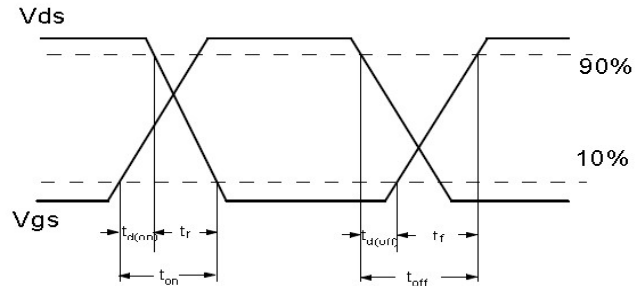
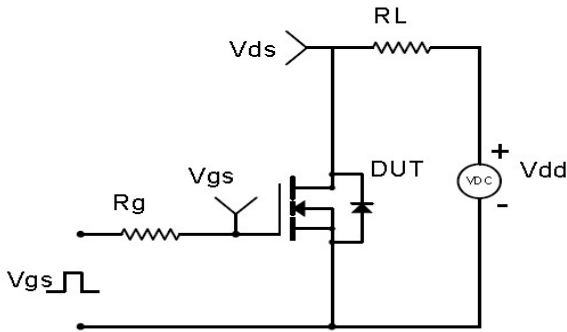

Unclamped Inductive Switching (UIS) Test Circuit & Waveforms

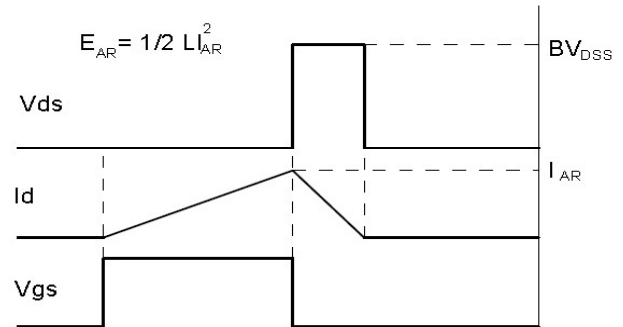
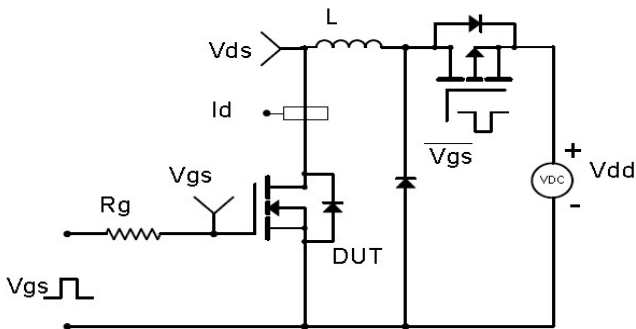

Diode Recovery Test Circuit & Waveforms

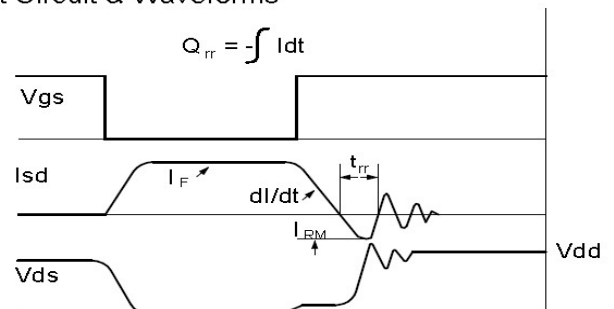
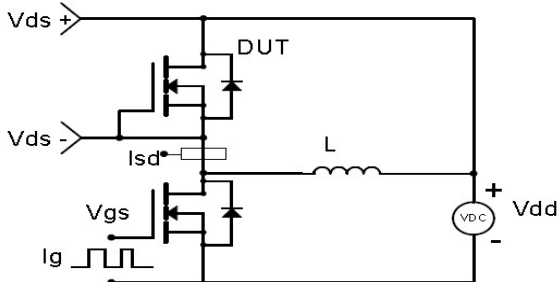

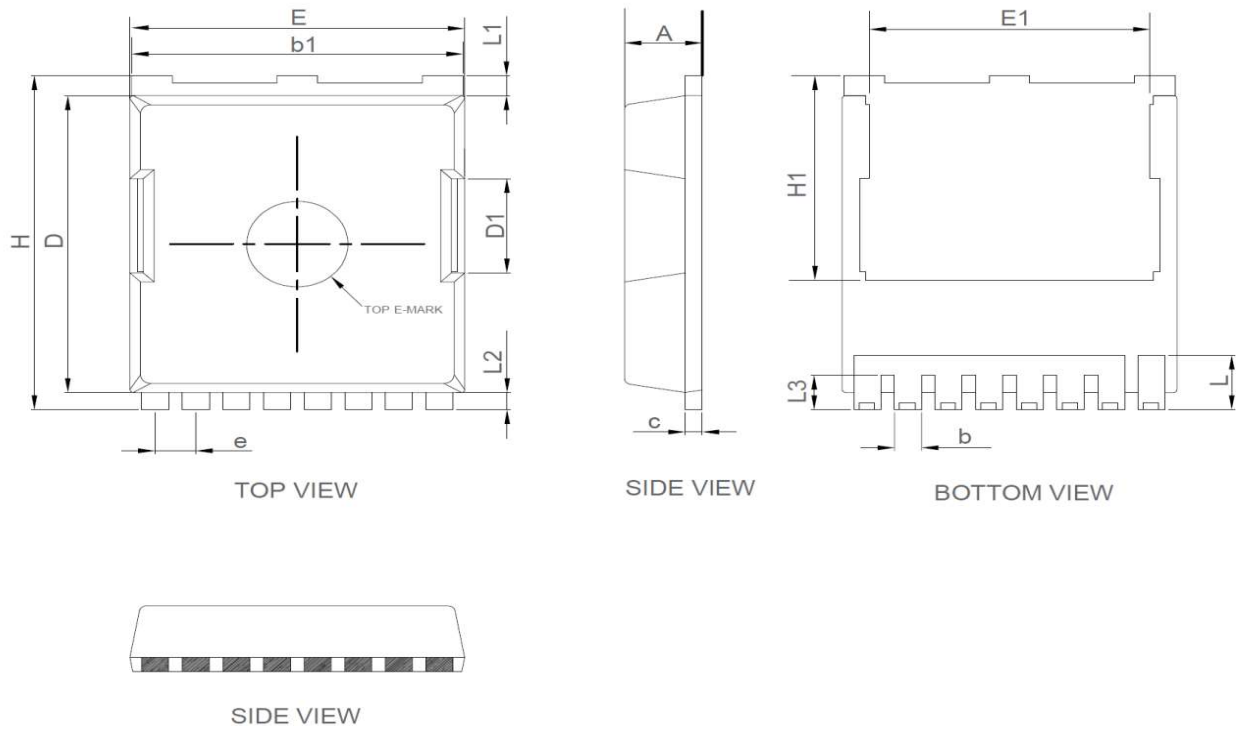
Package Outline: TOLL

Symbol	Dimensions In Millimeters		Dimensions In Inches	
	Min.	Max.	Min.	Max.
A	2.15	2.45	0.085	0.096
b	0.60	0.90	0.024	0.035
b1	9.65	9.95	0.380	0.392
c	0.35	0.65	0.014	0.026
D	10.18	10.70	0.401	0.421
D1	3.15	3.45	0.124	0.136
E	9.70	10.10	0.382	0.398
E1	7.35	8.45	0.289	0.333
e	1.10	1.30	0.043	0.051
H	11.45	11.95	0.451	0.470
H1	6.55	7.50	0.258	0.295
L	1.35	2.10	0.053	0.083
L1	0.50	0.90	0.020	0.035
L2	0.40	0.80	0.016	0.031
L3	0.95	1.35	0.037	0.053

Marking



NOTE:

NXBBAAAAY

- N —Wire Bond code
- X —Assembly location code
- BB —Fab code
- AAAA —Lot code
- Y —Bin code

Revision History

Revision	Date	Major changes
1.0	2023/9/13	Release of Preliminary version.
2.0	2023/10/26	Update Package Schematic Diagram

Disclaimer

Unless otherwise specified in the datasheet, the product is designed and qualified as a standard commercial product and is not intended for use in applications that require extraordinary levels of quality and reliability, such as automotive, aviation/aerospace and life-support devices or systems.

Any and all semiconductor products have certain probability to fail or malfunction, which may result in personal injury, death or property damage. Customer are solely responsible for providing adequate safe measures when design their systems.

CRM(CQ) reserves the right to improve product design, function and reliability without notice.

单击下面可查看定价，库存，交付和生命周期等信息

[>>CRMICRO\(华润微\)](#)