



DC Input 4-Pin Half Pitch Mini-Flat Phototransistor Optocoupler

Features

- High isolation 3750 V_{RMS}
- Multiple CTR selection available
- DC input with transistor output
- Operating temperature range - 55 °C to 125 °C
- RoHS compliance
- REACH compliance
- Halogen compliance
- Regulatory Approvals
 - UL - UL1577 (E364000)
 - VDE - EN60747-5-5(VDE0884-5)
 - CQC – GB4943.1, GB8898
 - IEC60065, IEC60950

Description

These series of general purpose optocoupler consists of a photo transistor optically coupled to a gallium arsenide Infrared-emitting diode in a 4-lead half pitch Mini-Flat package.

Applications

- DC-DC Converters
- Programmable controllers
- Telecommunication equipment
- Hybrid substrates that require high density mounting

Package Outline

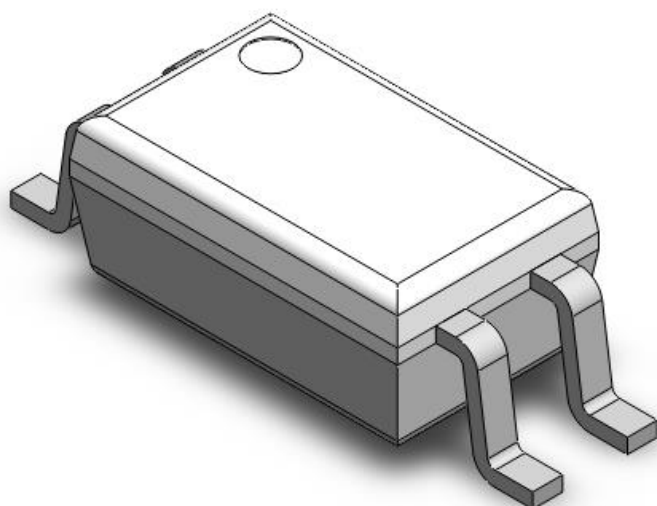

Schematic

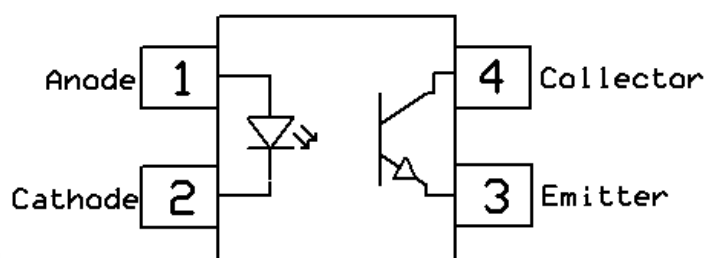



CTH217 Series

DC Input 4-Pin Half Pitch Mini-Flat

Phototransistor Optocoupler

Absolute Maximum Rating at 25°C

<i>Symbol</i>	<i>Parameters</i>	<i>Ratings</i>	<i>Units</i>	<i>Notes</i>
V _{ISO}	Isolation voltage	3750	V _{RMS}	
T _{OPR}	Operating temperature	-55 ~ +125	°C	
T _{STG}	Storage temperature	-55 ~ +150	°C	
T _{SOL}	Soldering temperature	260	°C	
P _{TOT}	Total power dissipation	200	mW	
Emitter				
I _F	Forward current	50	mA	
I _{F(TRANS)}	Peak transient current (≤1μs P.W,300pps)	1	A	
V _R	Reverse voltage	6	V	
P _D	Power dissipation	70	mW	
Detector				
P _C	Power dissipation	150	mW	
B _{VCEO}	Collector-Emitter Breakdown Voltage	80	V	
B _{VECO}	Emitter-Collector Breakdown Voltage	7	V	
I _C	Collector Current	50	mA	



CTH217 Series

DC Input 4-Pin Half Pitch Mini-Flat Phototransistor Optocoupler

Electrical Characteristics $T_A = 25^\circ\text{C}$ (unless otherwise specified)

Emitter Characteristics

Symbol	Parameters	Test Conditions	Min	Typ	Max	Units	Notes
V_F	Forward voltage	$I_F = 10\text{mA}$		1.24	1.4	V	
I_R	Reverse Current	$V_R = 6\text{V}$	-	-	5	μA	
C_{IN}	Input Capacitance	$f = 1\text{MHz}$	-	10	30	pF	

Detector Characteristics

Symbol	Parameters	Test Conditions	Min	Typ	Max	Units	Notes
$B_{V_{CEO}}$	Collector-Emitter Breakdown	$I_C = 0.1\text{mA}$	80	-	-	V	
$B_{V_{ECO}}$	Emitter-Collector Breakdown	$I_E = 0.1\text{mA}$	7	-	-	V	
I_{CEO}	Collector-Emitter Dark Current	$V_{CE} = 20\text{V}, I_F = 0\text{mA}$	-	-	100	nA	

Transfer Characteristics

Symbol	Parameters	Test Conditions	Min	Typ	Max	Units	Notes	
CTR	Current Transfer Ratio	$I_F = 5\text{mA}, V_{CE} = 5\text{V}$	CTH217	50		600	%	
			CTH217A	80		160		
			CTH217B	130		260		
			CTH217C	200		400		
			CTH217D	300		600		
$V_{CE(SAT)}$	Collector-Emitter Saturation Voltage	$I_F = 20\text{mA}, I_C = 1\text{mA}$	-	0.1	0.2	V		
R_{IO}	Isolation Resistance	$V_{IO} = 500\text{V}_{DC}$	5×10^{10}			Ω		
C_{IO}	Isolation Capacitance	$f = 1\text{MHz}$		0.5	1	pF		

Switching Characteristics

Symbol	Parameters	Test Conditions	Min	Typ	Max	Units	Notes
t_r	Rise Time	$I_C = 2\text{mA}, V_{CE} = 2\text{V}, R_L = 100\Omega$	-	6	18	μs	
t_f	Fall Time		-	8	18		



CTH217 Series DC Input 4-Pin Half Pitch Mini-Flat Phototransistor Optocoupler

Typical Characteristic Curves

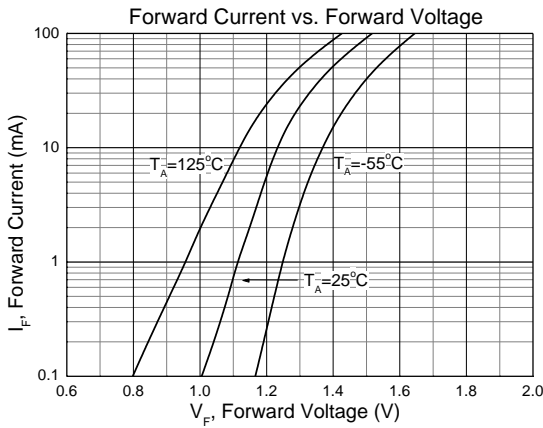

Figure 1

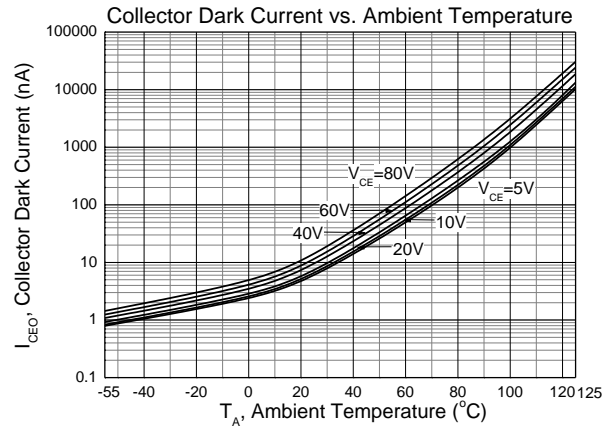

Figure 2

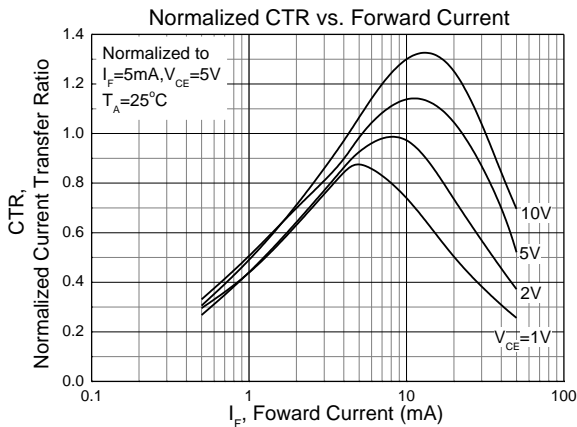

Figure 3

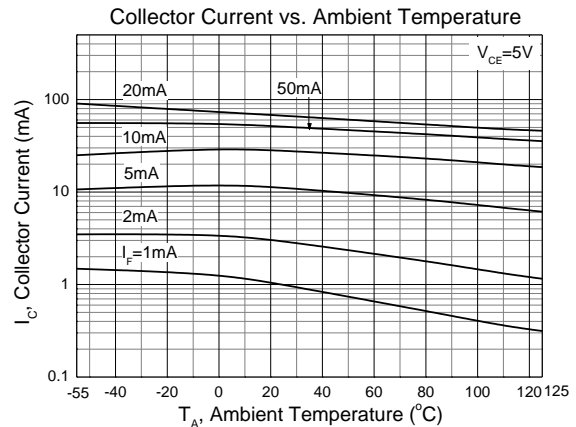

Figure 4

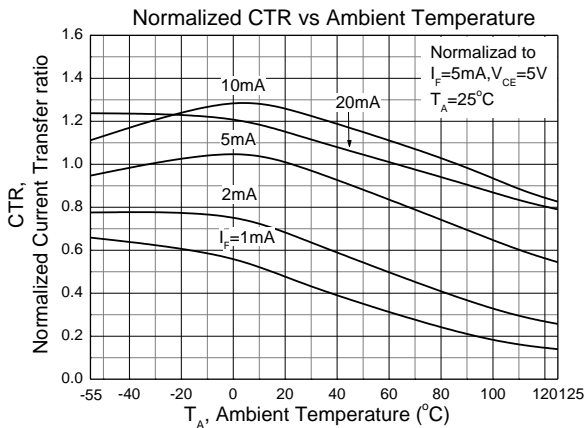

Figure 5

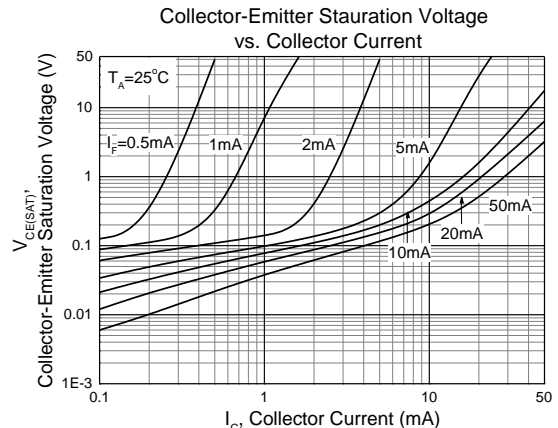

Figure 6



CTH217 Series

DC Input 4-Pin Half Pitch Mini-Flat

Phototransistor Optocoupler

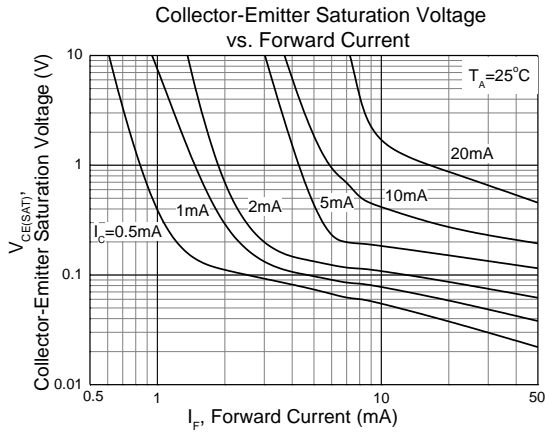

Figure 7

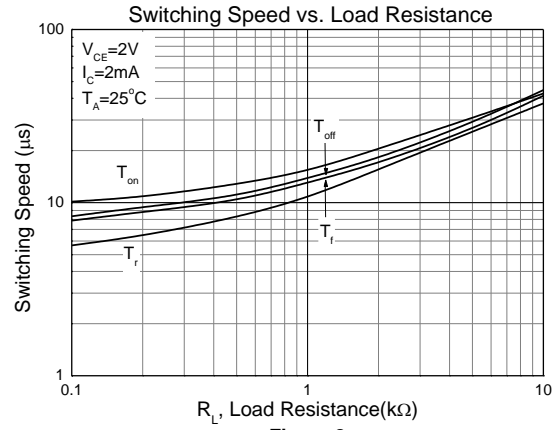

Figure 8

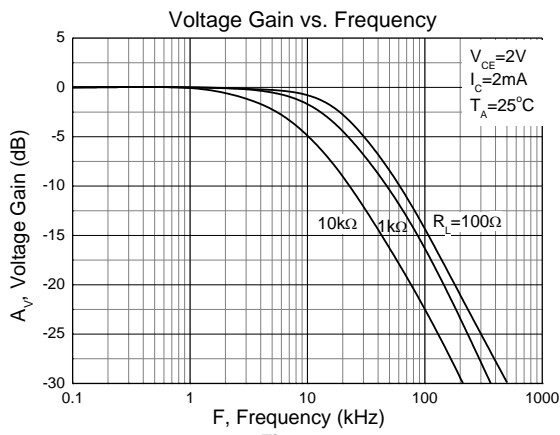

Figure 9

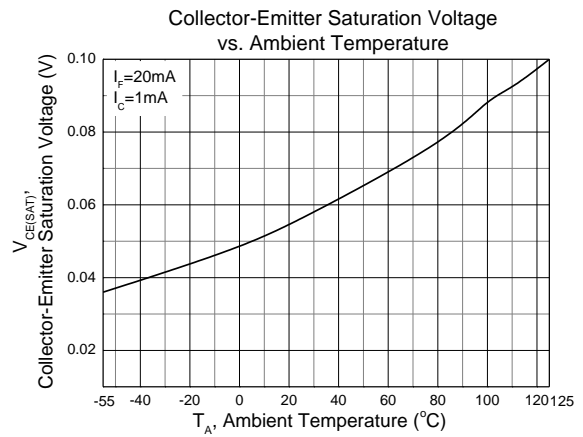

Figure 10



CTH217 Series DC Input 4-Pin Half Pitch Mini-Flat Phototransistor Optocoupler

Test Circuit

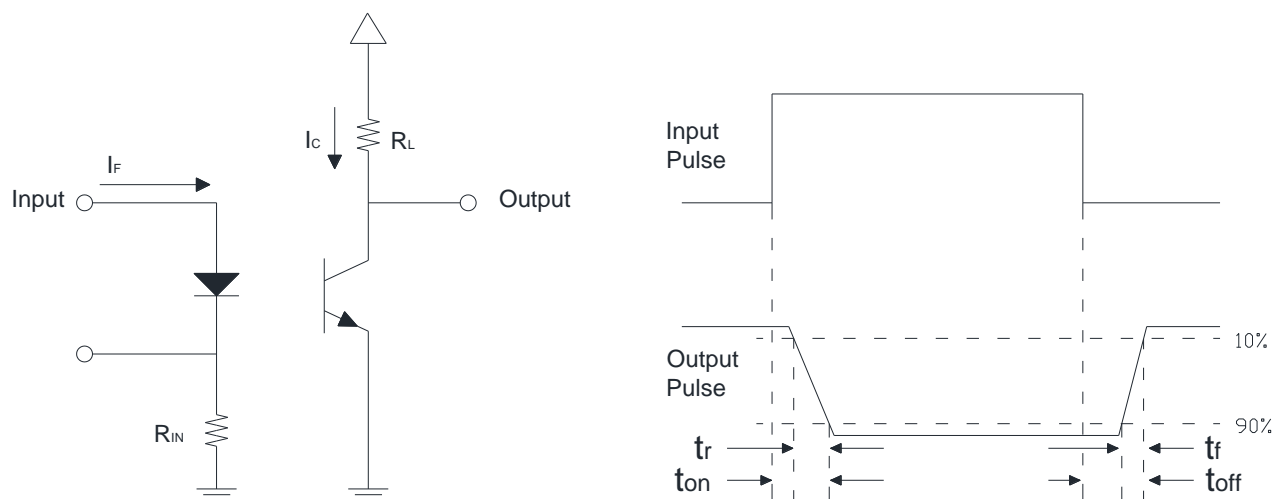

Figure 11: Switching Time Test Circuits



CTH217 Series

DC Input 4-Pin Half Pitch Mini-Flat

Phototransistor Optocoupler

Package Dimension *Dimensions in mm unless otherwise stated*

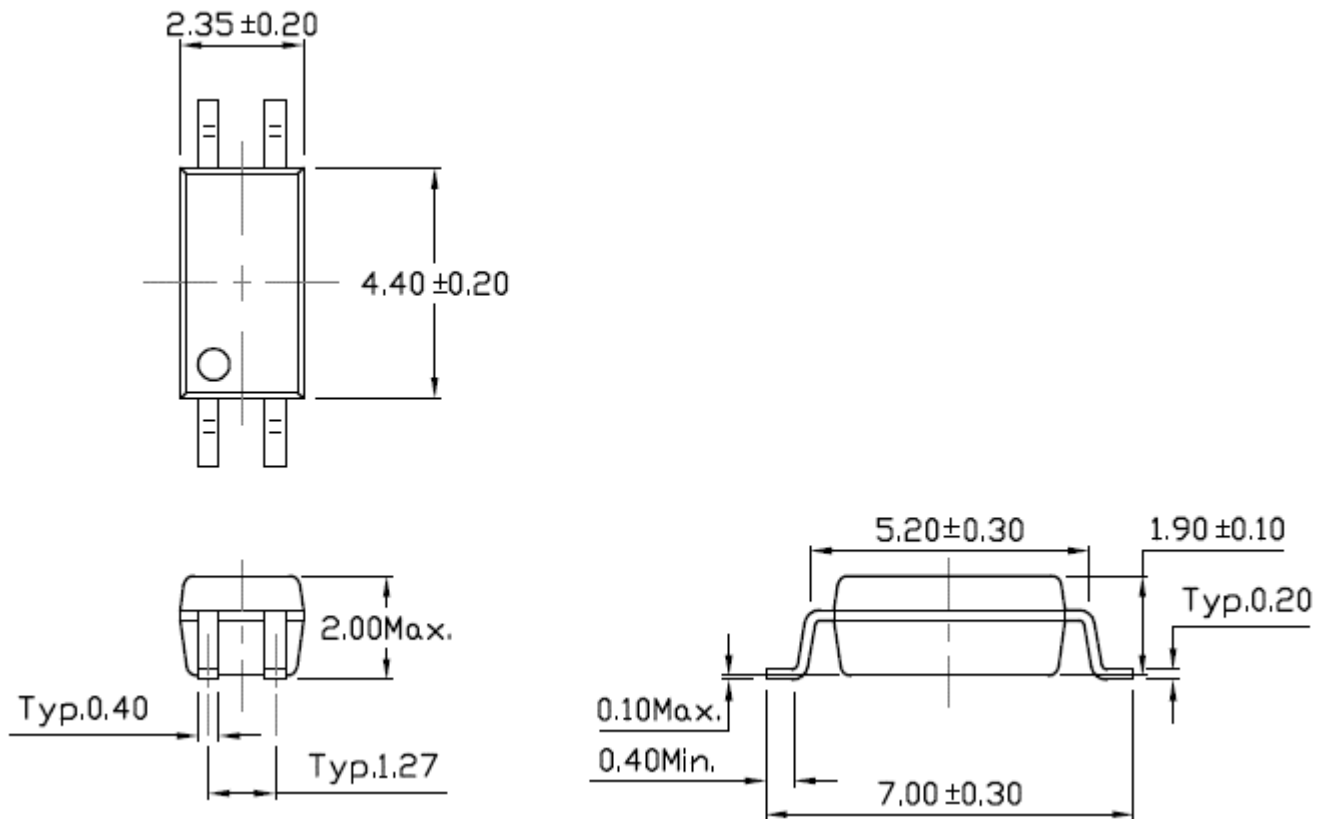

Recommended Solder Mask *Dimensions in mm unless otherwise stated*

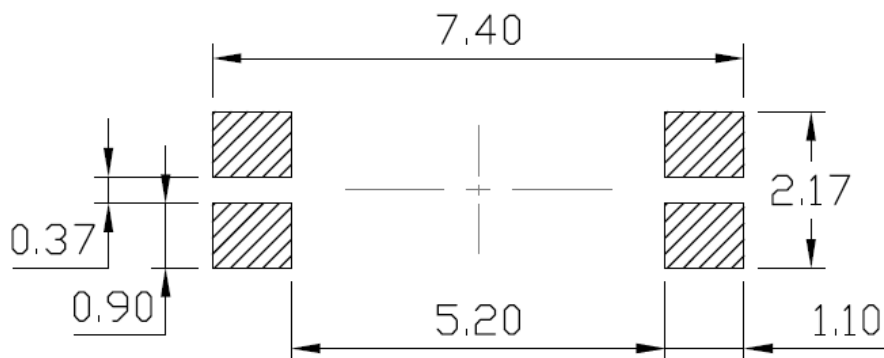



CTH217 Series

DC Input 4-Pin Half Pitch Mini-Flat Phototransistor Optocoupler

Marking Information



Note:

- CT : Denotes "CT Micro"
- 217 : Product Number
- R : CTR Rank
- V : VDE Option
- Y : Fiscal Year
- WW : Work Week
- K : Manufacturing Code

Ordering Information

CTH217X(V)(Z)

X = Part No. (X=A, B, C, D or none)

V = VDE Option (V or none)

Z = Tape and reel option (T1 or T2)

Option	Description	Quantity
T1	Surface Mount Lead Forming – With Option 1 Taping	5000 Units/Reel
T2	Surface Mount Lead Forming – With Option 2 Taping	5000 Units/Reel



CTH217 Series

DC Input 4-Pin Half Pitch Mini-Flat

Phototransistor Optocoupler

Carrier Tape Specifications *Dimensions in mm unless otherwise stated*

Option T1

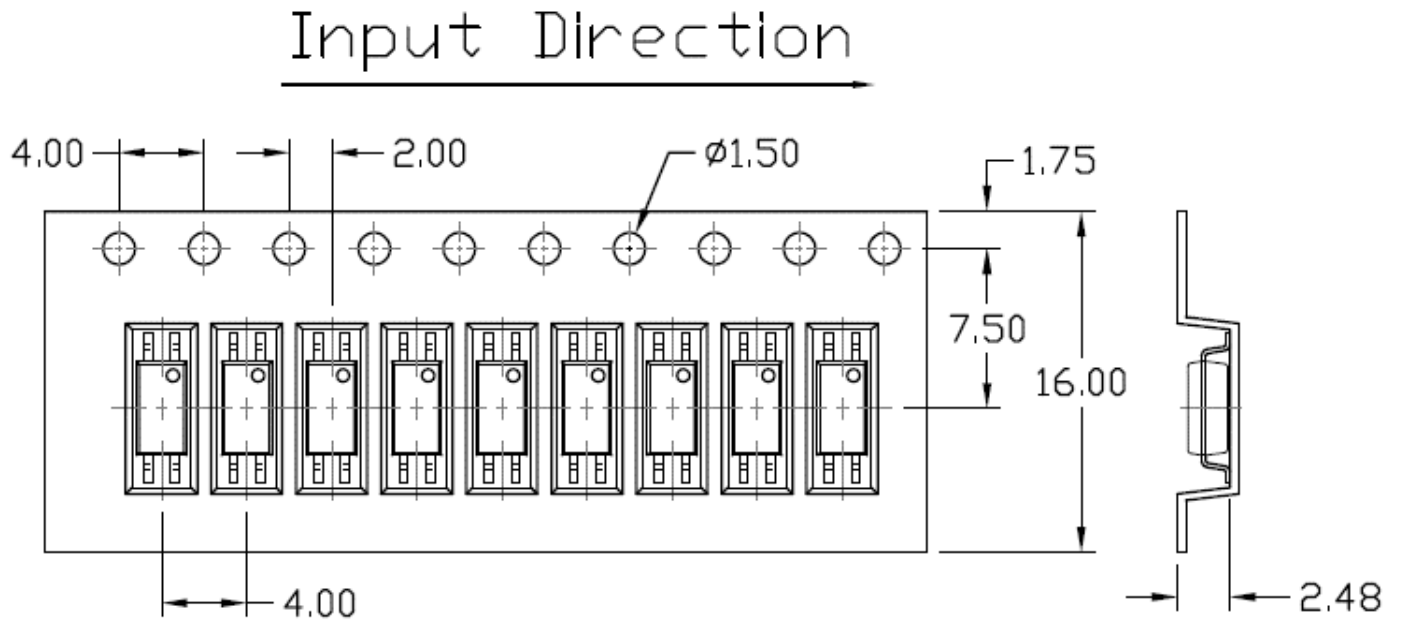

Option T2

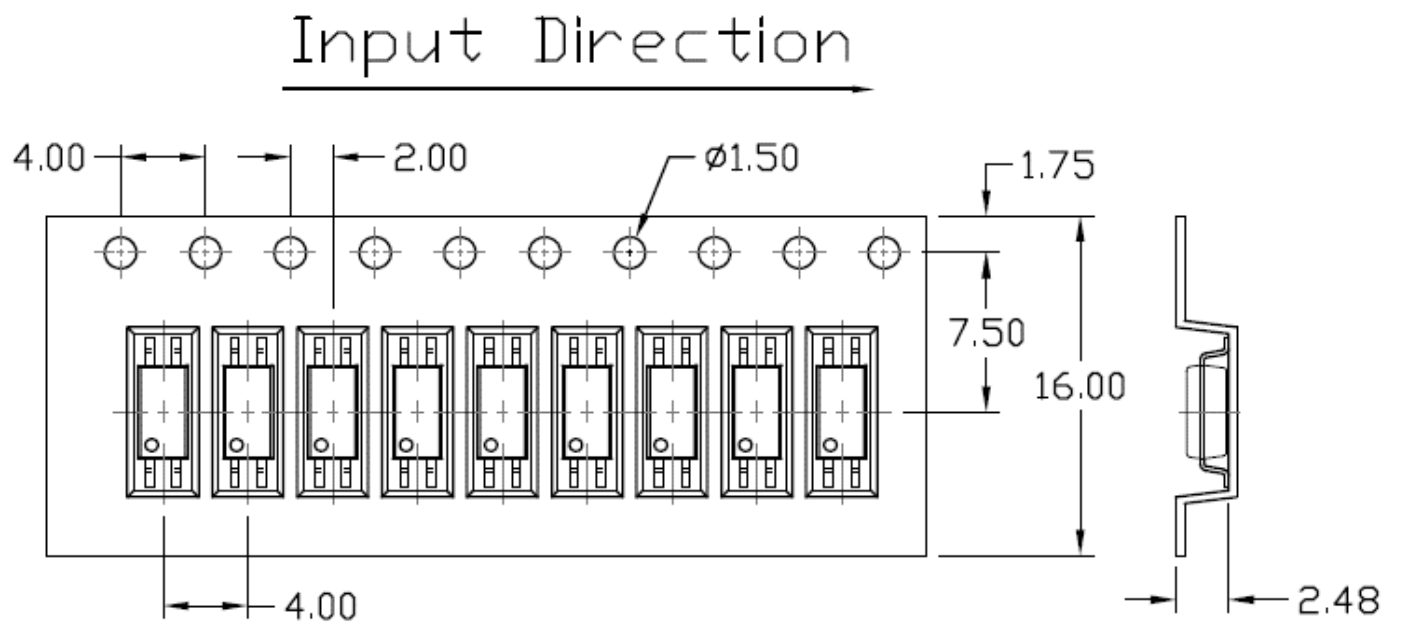



DC Input 4-Pin Half Pitch Mini-Flat
Phototransistor Optocoupler

Reflow Profile

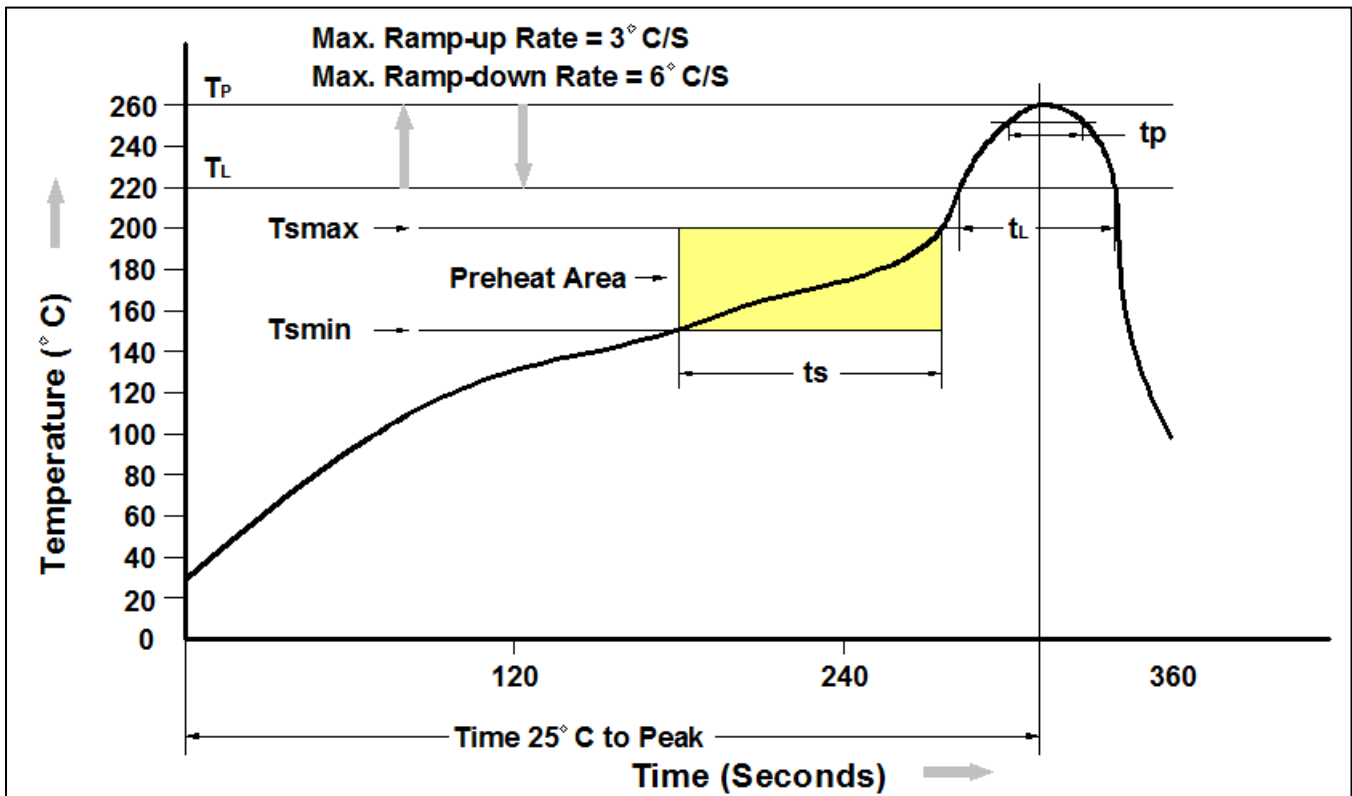

Profile Feature	Pb-Free Assembly Profile
Temperature Min. (Tsmin)	150°C
Temperature Max. (Tsmax)	200°C
Time (ts) from (Tsmin to Tsmax)	60-120 seconds
Ramp-up Rate (tL to tp)	3°C/second max.
Liquidous Temperature (TL)	217°C
Time (tL) Maintained Above (TL)	60 – 150 seconds
Peak Body Package Temperature	260°C +0°C / -5°C
Time (tp) within 5°C of 260°C	30 seconds
Ramp-down Rate (TP to TL)	6°C/second max
Time 25°C to Peak Temperature	8 minutes max.



CTH217 Series

DC Input 4-Pin Half Pitch Mini-Flat Phototransistor Optocoupler

DISCLAIMER

CT MICRO RESERVES THE RIGHT TO MAKE CHANGES WITHOUT FURTHER NOTICE TO ANY PRODUCTS HEREIN TO IMPROVE RELIABILITY, FUNCTION OR DESIGN. CT MICRO DOES NOT ASSUME ANY LIABILITY ARISING OUT OF THE APPLICATION OR USE OF ANY PRODUCT OR CIRCUIT DESCRIBED HEREIN; NEITHER DOES IT CONVEY ANY LICENSE UNDER ITS PATENT RIGHTS, NOR THE RIGHTS OF OTHERS.

DISCOLORATION MIGHT OCCUR ON THE PACKAGE SURFACE AFTER SOLDERING, REFLOW OR LONG TERM USE. THIS DOES NOT IMPACT THE PRODUCT PERFORMANCE NOR THE PRODUCT RELIABILITY.

CT MICRO ARE NOT AUTHORIZED FOR USE AS CRITICAL COMPONENTS IN LIFE SUPPORT DEVICES OR SYSTEMS WITHOUT EXPRESS WRITTEN APPROVAL OF CT MICRO INTERNATIONAL CORPORATION.

- 1. Life support devices or systems are devices or systems which, (a) are intended for surgical implant into the body, or (b) support or sustain life, or (c) whose failure to perform when properly used in accordance with instruction for use provided in the labelling, can be reasonably expected to result in significant injury to the user.*
- 2. A critical component is any component of a life support device or system whose failure to perform can be reasonably expected to cause the failure of the life support device or system, or to affect its safety or effectiveness.*

单击下面可查看定价，库存，交付和生命周期等信息

[>>CT-MICRO\(兆龙科技\)](#)