



# CTH214 Series AC Input 4-Pin Half Pitch Mini-Flat Phototransistor Optocoupler

## Features

- High isolation 3750 VRMS
- CTR flexibility available see order information
- DC input with transistor output
- Operating Temperature range - 55 °C to 110 °C
- Regulatory Approvals
  - UL - UL1577 (E364000)
  - VDE - EN60747-5-5(VDE0884-5)
  - CQC – GB4943.1, GB8898
  - IEC60065, IEC60950
- Green Package

## Description

The CTH214 series consists of a phototransistor optically coupled to two gallium arsenide Infrared-emitting diode, connected in inverse parallel in a 4-lead half pitch Mini-Flat package.

## Applications

- Switch mode power supplies
- Computer peripheral interface
- Microprocessor system interface

## Package Outline

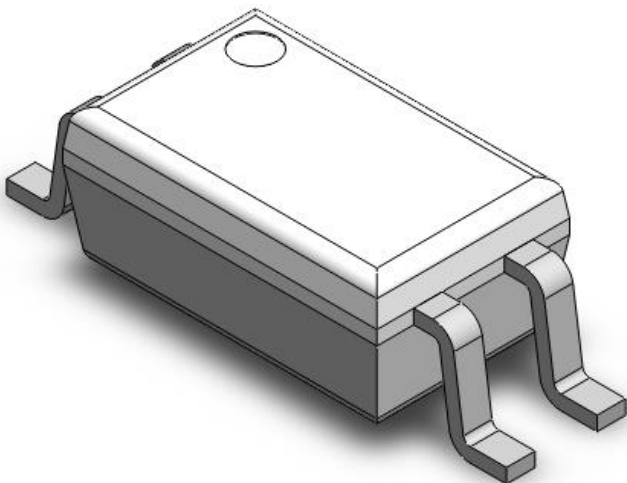

## Schematic

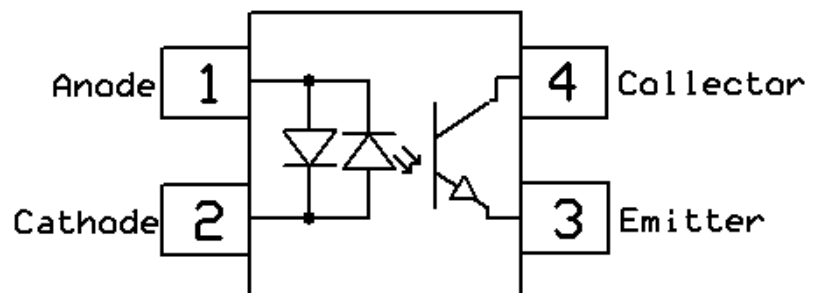



# CTH214 Series

## AC Input 4-Pin Half Pitch Mini-Flat Phototransistor Optocoupler

### Absolute Maximum Rating at 25°C

| <b>Symbol</b>         | <b>Parameters</b>                        | <b>Ratings</b> | <b>Units</b>     | <b>Notes</b> |
|-----------------------|--|----------------|------------------|--------------|
| V <sub>ISO</sub>      | Isolation voltage                        | 3750           | V <sub>RMS</sub> |              |
| P <sub>TOT</sub>      | Total power dissipation                  | 200            | mW               |              |
| T <sub>OPR</sub>      | Operating temperature                    | -55 ~ +110     | °C               |              |
| T <sub>STG</sub>      | Storage temperature                      | -55 ~ +150     | °C               |              |
| T <sub>SOL</sub>      | Soldering temperature                    | 260            | °C               |              |
| <b>Emitter</b>        |  |                |                  |              |
| I <sub>F</sub>        | Forward current                          | ±50            | mA               |              |
| I <sub>F(TRANS)</sub> | Peak transient current (≤1μs P.W,300pps) | 1              | A                |              |
| P <sub>D</sub>        | Emitter power dissipation                | 70             | mW               |              |
| <b>Detector</b>       |  |                |                  |              |
| P <sub>D</sub>        | Detector power dissipation               | 150            | mW               |              |
| B <sub>VCEO</sub>     | Collector-Emitter Breakdown Voltage      | 80             | V                |              |
| B <sub>VECO</sub>     | Emitter-Collector Breakdown Voltage      | 6              | V                |              |
| I <sub>C</sub>        | Collector Current                        | 50             | mA               |              |



# CTH214 Series

## AC Input 4-Pin Half Pitch Mini-Flat Phototransistor Optocoupler

### Electrical Characteristics $T_A = 25^\circ\text{C}$ (unless otherwise specified)

#### Emitter Characteristics

| Symbol   | Parameters        | Test Conditions         | Min | Typ  | Max | Units | Notes |
|----------|-------------------|-------------------------|-----|------|-----|-------|-------|
| $V_F$    | Forward voltage   | $I_F = \pm 10\text{mA}$ |     | 1.24 | 1.4 | V     |       |
| $C_{IN}$ | Input Capacitance | $f = 1\text{MHz}$       | -   | 30   | -   | pF    |       |

#### Detector Characteristics

| Symbol        | Parameters                     | Test Conditions                         | Min | Typ | Max | Units | Notes |
|---------------|--------------------------------|---|-----|-----|-----|-------|-------|
| $B_{V_{CEO}}$ | Collector-Emitter Breakdown    | $I_C = 100\mu\text{A}$                  | 80  | -   | -   | V     |       |
| $B_{V_{ECO}}$ | Emitter-Collector Breakdown    | $I_E = 100\mu\text{A}$                  | 6   | -   | -   | V     |       |
| $I_{CEO}$     | Collector-Emitter Dark Current | $V_{CE} = 20\text{V}, I_F = 0\text{mA}$ | -   | -   | 100 | nA    |       |

#### Transfer Characteristics

| Symbol        | Parameters                           | Test Conditions                            | Min  | Typ  | Max | Units    | Notes |
|---------------|--------------------------------------|--|--|------|-----|----------|-------|
| CTR           | Current Transfer Ratio               | CTH214                                     | $I_F = \pm 1\text{mA}, V_{CE} = 5\text{V}$ | 20   | -   | 300      | %     |
|               |                                      | CTH214A                                    |  | 50   | -   | 150      |       |
| CTR           | Current Transfer Ratio               | CTH214                                     | $I_F = \pm 5\text{mA}, V_{CE} = 5\text{V}$ | 30   | -   | 600      | %     |
|               |                                      | CTH214A                                    |  | 80   | -   | 300      |       |
|               | CTR Symmetry                         | $I_F = \pm 1\text{mA}, V_{CE} = 5\text{V}$ | 0.7  | -    | 1.3 |          |       |
| $V_{CE(SAT)}$ | Collector-Emitter Saturation Voltage | $I_F = \pm 20\text{mA}, I_C = 1\text{mA}$  | -  | 0.04 | 0.2 | V        |       |
| $R_{IO}$      | Isolation Resistance                 | $V_{IO} = 500\text{V}_{DC}$                | $5 \times 10^{10}$                         | -    | -   | $\Omega$ |       |
| $C_{IO}$      | Isolation Capacitance                | $f = 1\text{MHz}$                          | -  | 0.5  | 1   | pF       |       |

#### Switching Characteristics

| Symbol | Parameters | Test Conditions   | Min | Typ | Max | Units         | Notes |
|--------|------------|---|-----|-----|-----|---------------|-------|
| $t_r$  | Rise Time  | $I_C = 2\text{mA}, V_{CE} = 2\text{V}, R_L = 100\Omega$ | -   | 6   | -   | $\mu\text{s}$ |       |
| $t_f$  | Fall Time  |   | -   | 8   | -   |               |       |



# CTH214 Series AC Input 4-Pin Half Pitch Mini-Flat Phototransistor Optocoupler

## Typical Characteristic Curves

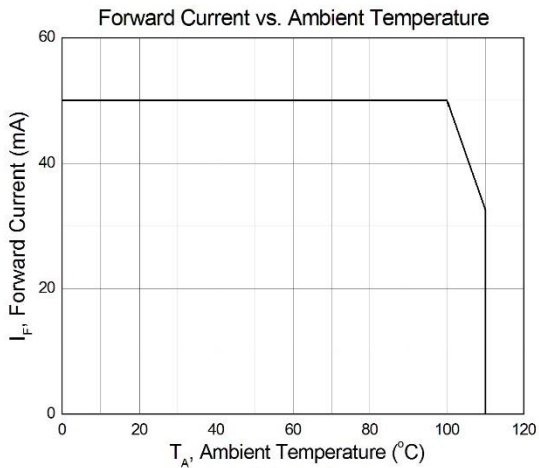

Figure 1

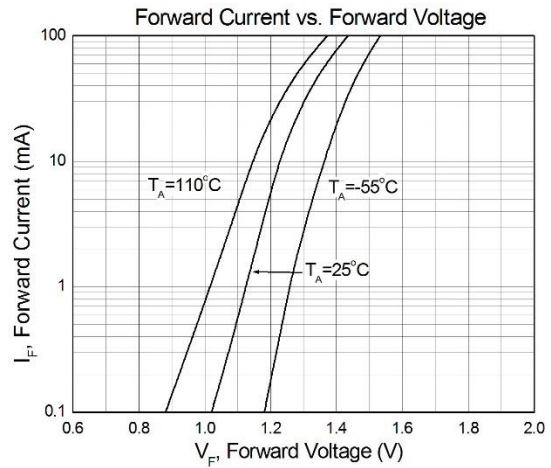

Figure 2

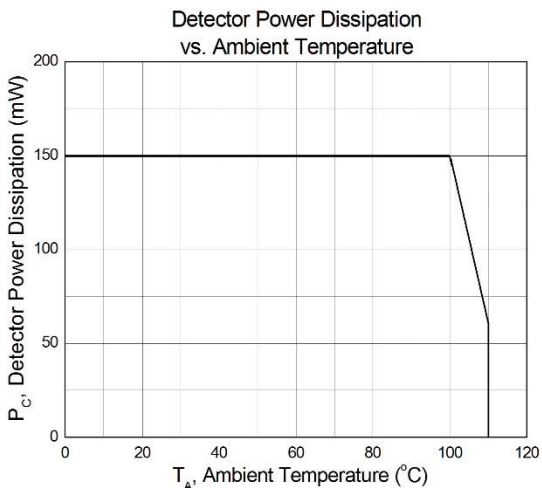

Figure 3

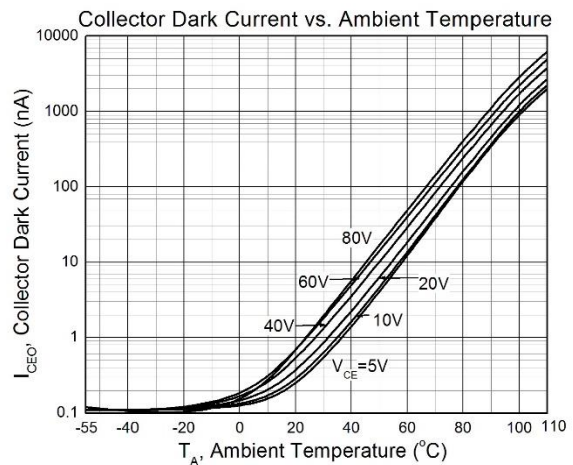

Figure 4

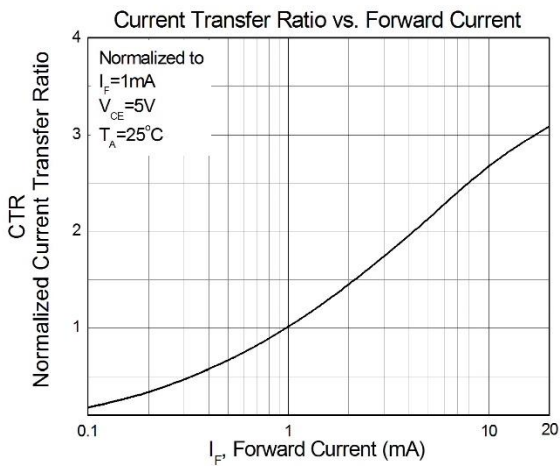

Figure 5

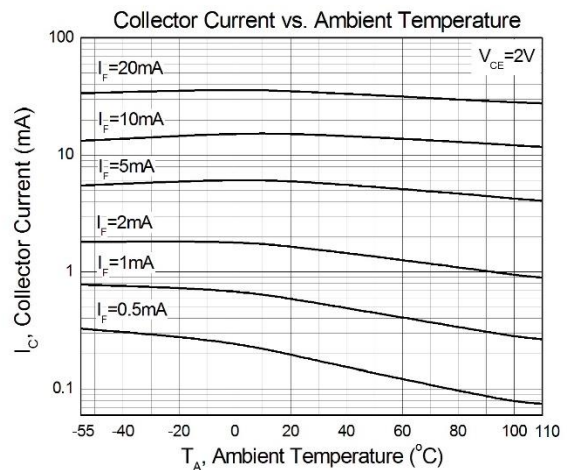

Figure 6



# CTH214 Series AC Input 4-Pin Half Pitch Mini-Flat Phototransistor Optocoupler

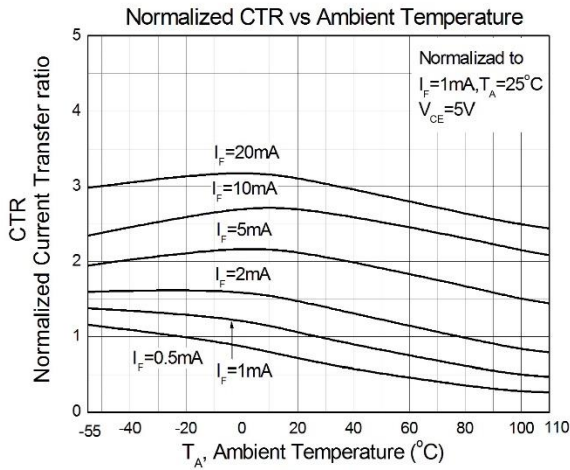

Figure 7

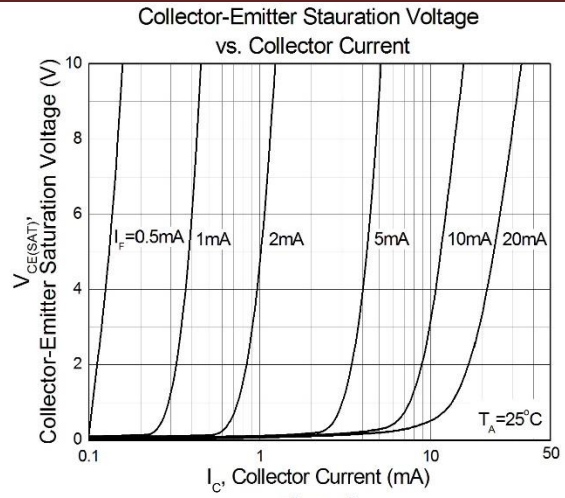

Figure 8

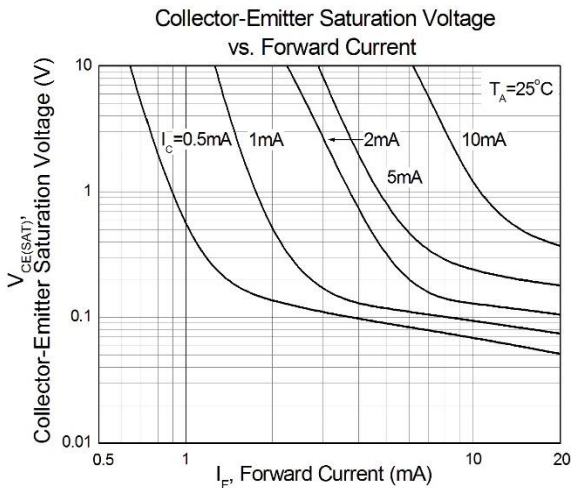

Figure 9

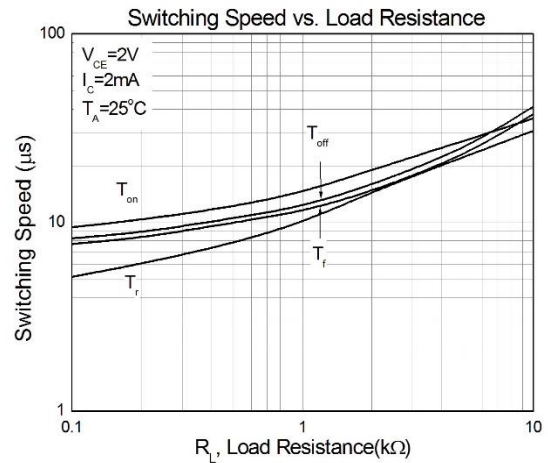

Figure 10

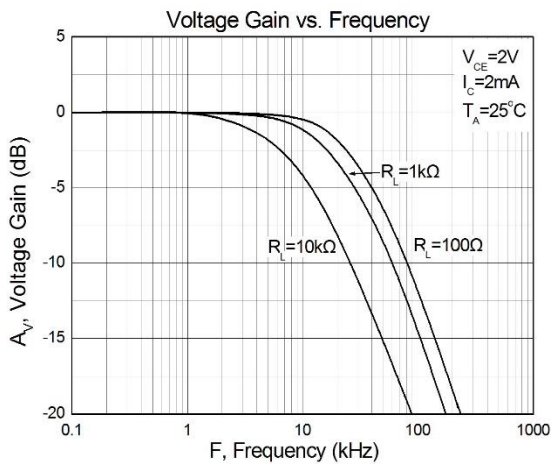

Figure 11

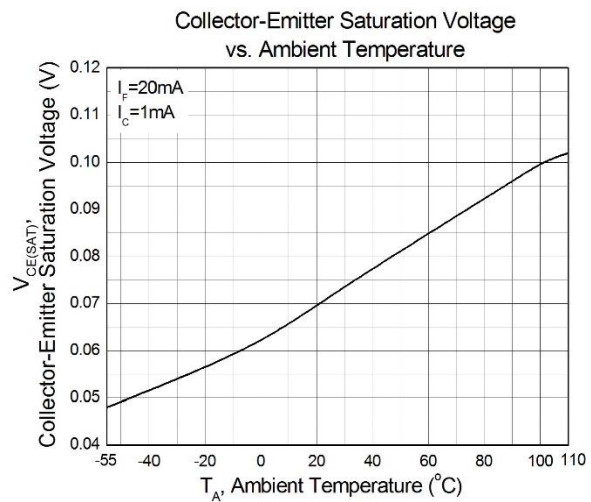
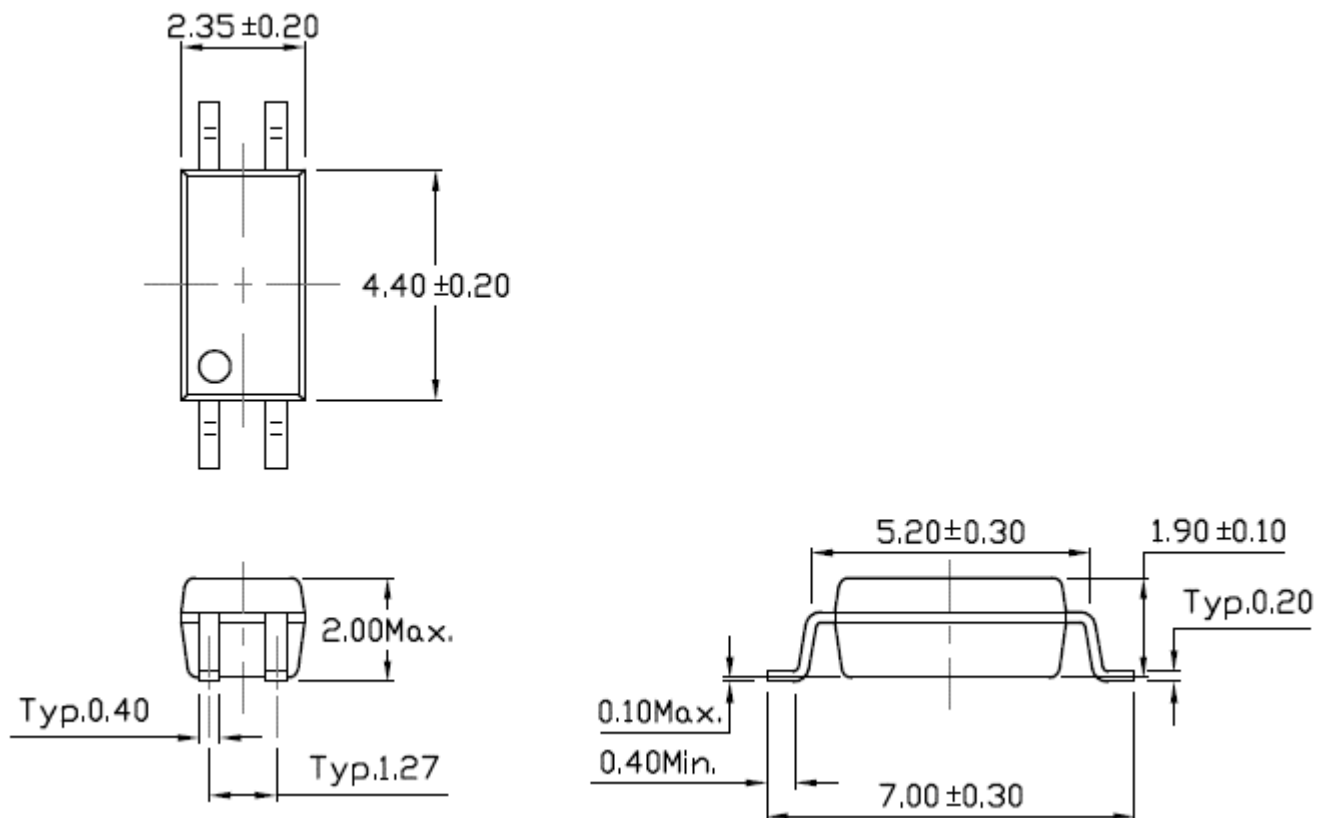

Figure 12



# CTH214 Series AC Input 4-Pin Half Pitch Mini-Flat Phototransistor Optocoupler

## Package Dimension *Dimensions in mm unless otherwise stated*



## Recommended Solder Mask *Dimensions in mm unless otherwise stated*

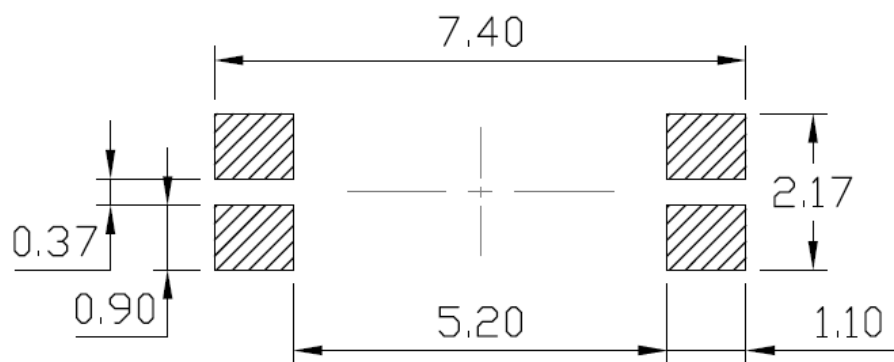



# CTH214 Series

## AC Input 4-Pin Half Pitch Mini-Flat

### Phototransistor Optocoupler

### Marking Information

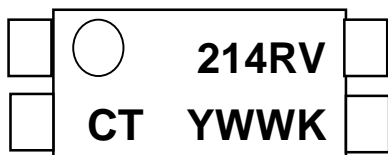

#### Note:

- CT : Denotes "CT Micro"
- 214 : Product Number
- R : CTR Rank
- V : VDE Option
- Y : Fiscal Year
- WW : Work Week
- K : Manufacturing Code

### Ordering Information

#### CTH214X(V)(Z)

X = Part No. (X=A or none)

V = VDE Option (V or none)

Z = Tape and reel option (T1 or T2)

| <b>Option</b> | <b>Description</b>                                | <b>Quantity</b> |
|---------------|---|-----------------|
| T1            | Surface Mount Lead Forming – With Option 1 Taping | 5000 Units/Reel |
| T2            | Surface Mount Lead Forming – With Option 2 Taping | 5000 Units/Reel |



# CTH214 Series AC Input 4-Pin Half Pitch Mini-Flat Phototransistor Optocoupler

## Carrier Tape Specifications *Dimensions in mm unless otherwise stated*

### Option T1

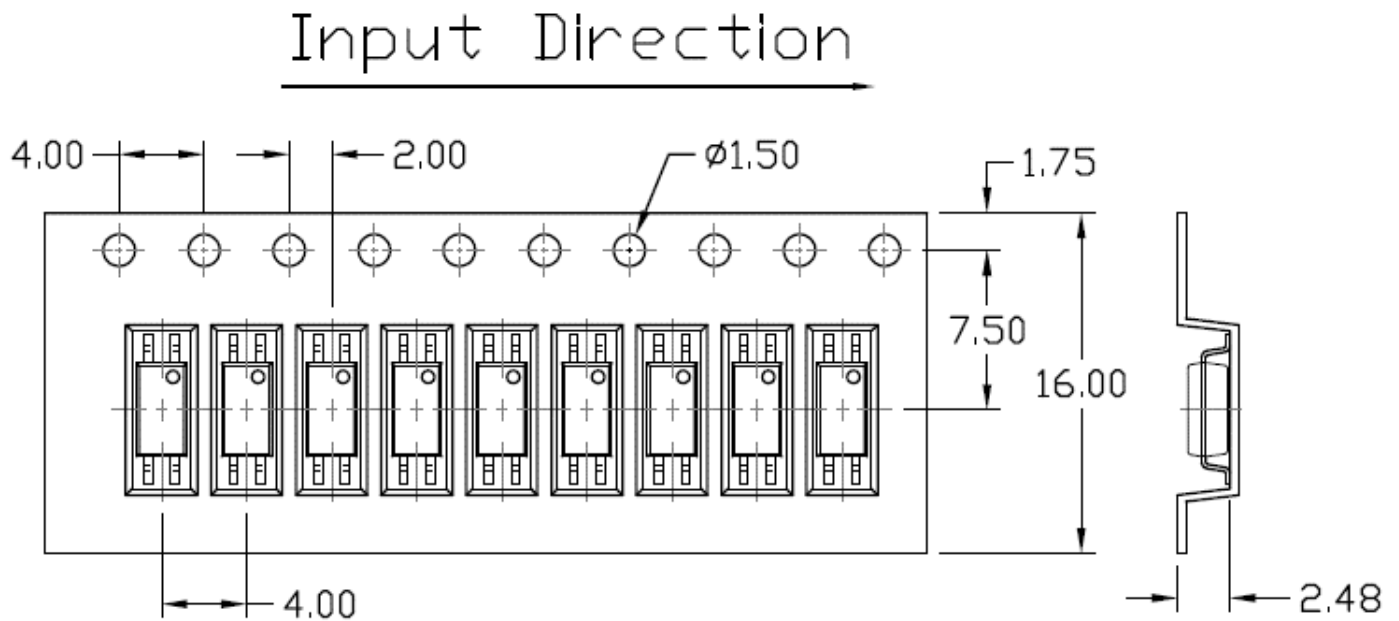

### Option T2

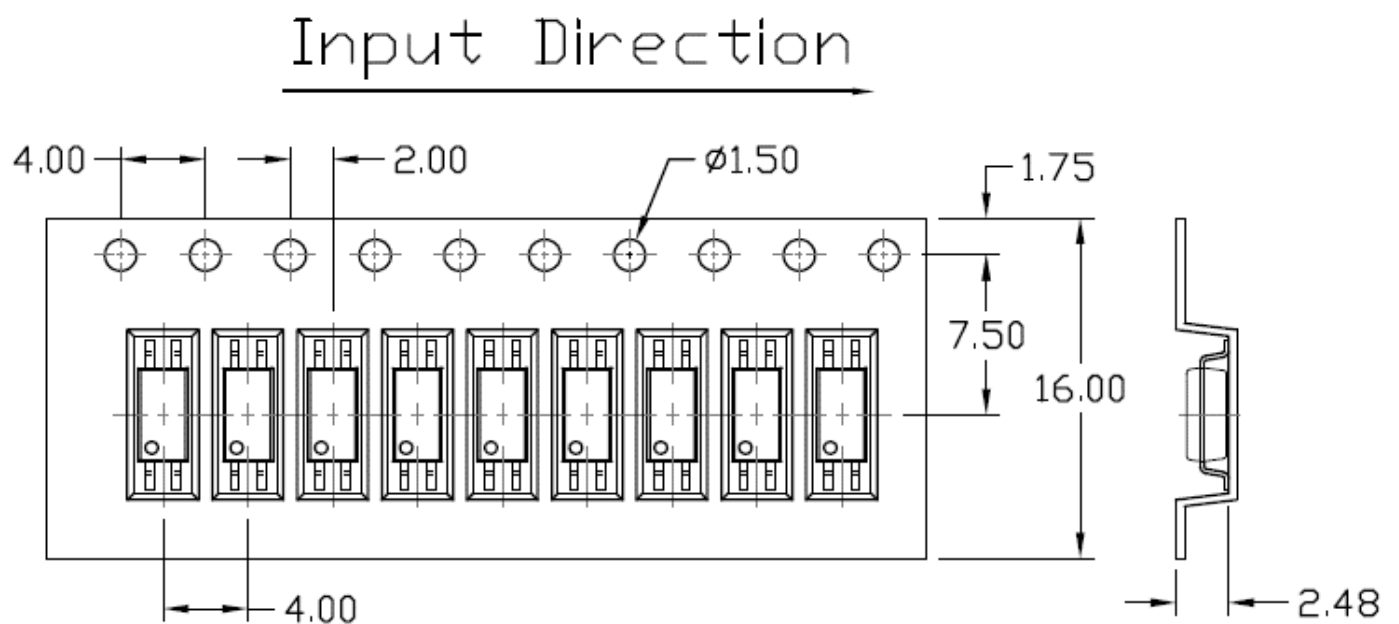





# CTH214 Series

## AC Input 4-Pin Half Pitch Mini-Flat Phototransistor Optocoupler

### Reflow Profile

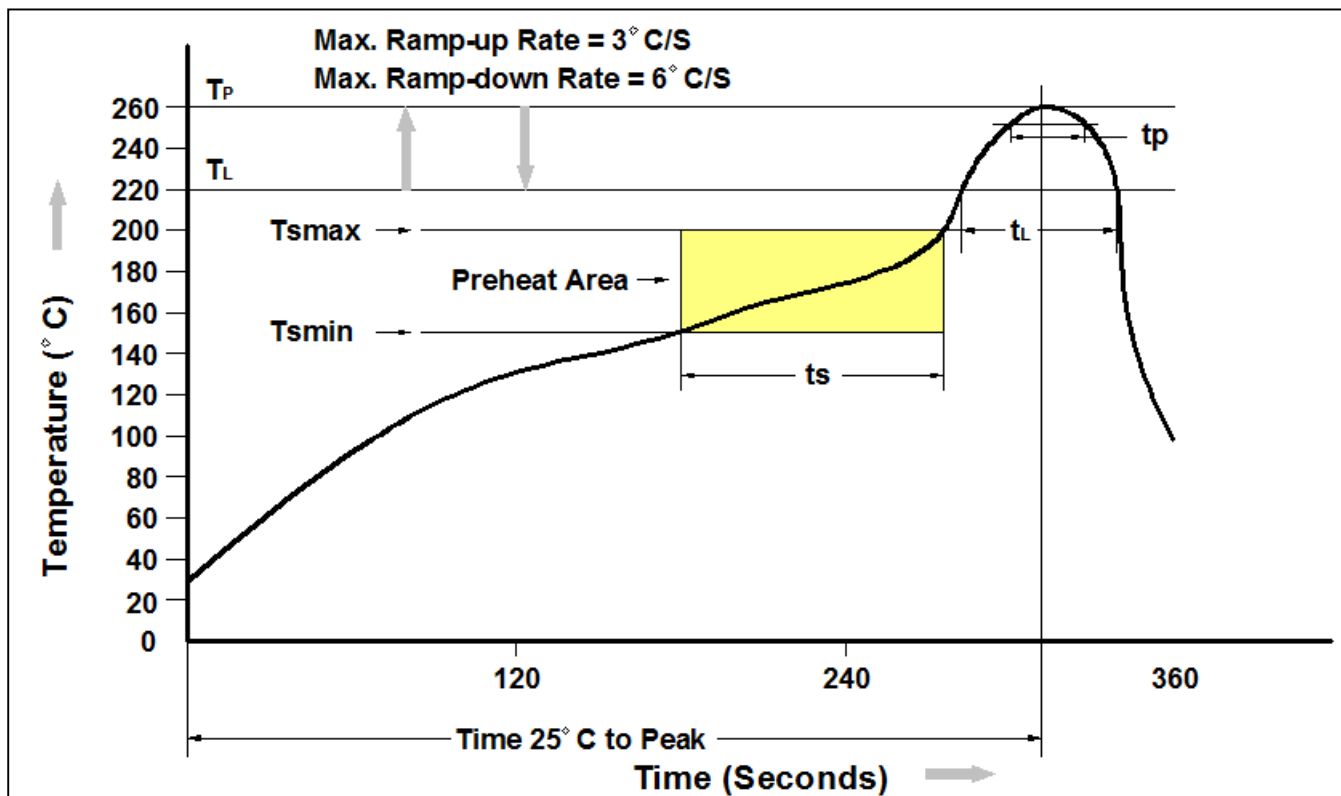

| Profile Feature   | Pb-Free Assembly Profile |
|---|--------------------------|
| Temperature Min. (Tsmin)                                  | 150°C                    |
| Temperature Max. (Tsmax)                                  | 200°C                    |
| Time (ts) from (Tsmin to Tsmax)                           | 60-120 seconds           |
| Ramp-up Rate (t <sub>L</sub> to t <sub>P</sub> )          | 3°C/second max.          |
| Liquidous Temperature (T <sub>L</sub> )                   | 217°C                    |
| Time (t <sub>L</sub> ) Maintained Above (T <sub>L</sub> ) | 60 – 150 seconds         |
| Peak Body Package Temperature                             | 260°C +0°C / -5°C        |
| Time (t <sub>P</sub> ) within 5°C of 260°C                | 30 seconds               |
| Ramp-down Rate (T <sub>P</sub> to T <sub>L</sub> )        | 6°C/second max           |
| Time 25°C to Peak Temperature                             | 8 minutes max.           |



# CTH214 Series

## AC Input 4-Pin Half Pitch Mini-Flat Phototransistor Optocoupler

---

### DISCLAIMER

CT MICRO RESERVES THE RIGHT TO MAKE CHANGES WITHOUT FURTHER NOTICE TO ANY PRODUCTS HEREIN TO IMPROVE RELIABILITY, FUNCTION OR DESIGN. CT MICRO DOES NOT ASSUME ANY LIABILITY ARISING OUT OF THE APPLICATION OR USE OF ANY PRODUCT OR CIRCUIT DESCRIBED HEREIN; NEITHER DOES IT CONVEY ANY LICENSE UNDER ITS PATENT RIGHTS, NOR THE RIGHTS OF OTHERS.

---

DISCOLORATION MIGHT OCCUR ON THE PACKAGE SURFACE AFTER SOLDERING, REFLOW OR LONG TERM USE. THIS DOES NOT IMPACT THE PRODUCT PERFORMANCE NOR THE PRODUCT RELIABILITY.

---

CT MICRO ARE NOT AUTHORIZED FOR USE AS CRITICAL COMPONENTS IN LIFE SUPPORT DEVICES OR SYSTEMS WITHOUT EXPRESS WRITTEN APPROVAL OF CT MICRO INTERNATIONAL CORPORATION.

- 1. Life support devices or systems are devices or systems which, (a) are intended for surgical implant into the body, or (b) support or sustain life, or (c) whose failure to perform when properly used in accordance with instruction for use provided in the labelling, can be reasonably expected to result in significant injury to the user.*
- 2. A critical component is any component of a life support device or system whose failure to perform can be reasonably expected to cause the failure of the life support device or system, or to affect its safety or effectiveness.*

单击下面可查看定价，库存，交付和生命周期等信息

[>>CT-MICRO\(兆龙科技\)](#)