

## SPECIFICATIONS

- CONTACT RATING:** Dependent upon contact material  
**MECHANICAL LIFE:** 30,000 make-and-break cycles.  
**CONTACT RESISTANCE:** 10 mΩ max. initial @ 2-4VDC  
 100mA for both silver and gold plated contacts.  
**INSULATION RESISTANCE:** 1,000 MΩ min.  
**DIELECTRIC STRENGTH:** 1,000 Vrms min. @ sea level.  
**OPERATING TEMPERATURE:** -40°C to 85°C.

## MATERIALS

- CASE:** Diallyl phthalate (DAP) (UL94v-0).  
**HOUSING:** Stainless Steel.  
**ACTUATOR:** Nylon, black std.  
**CONTACT/TERMINALS:** Copper alloy, with silver or gold plated.  
**TERMINAL SEAL:** Epoxy.



5M  
Slide Switches

## HOW TO ORDER

MODEL NO.    ACTUATOR    ACTUATOR COLOR    MOUNTING EARS    TERMINATIONS    TERMINAL PLATING    SEAL    RoHS SOLDERING

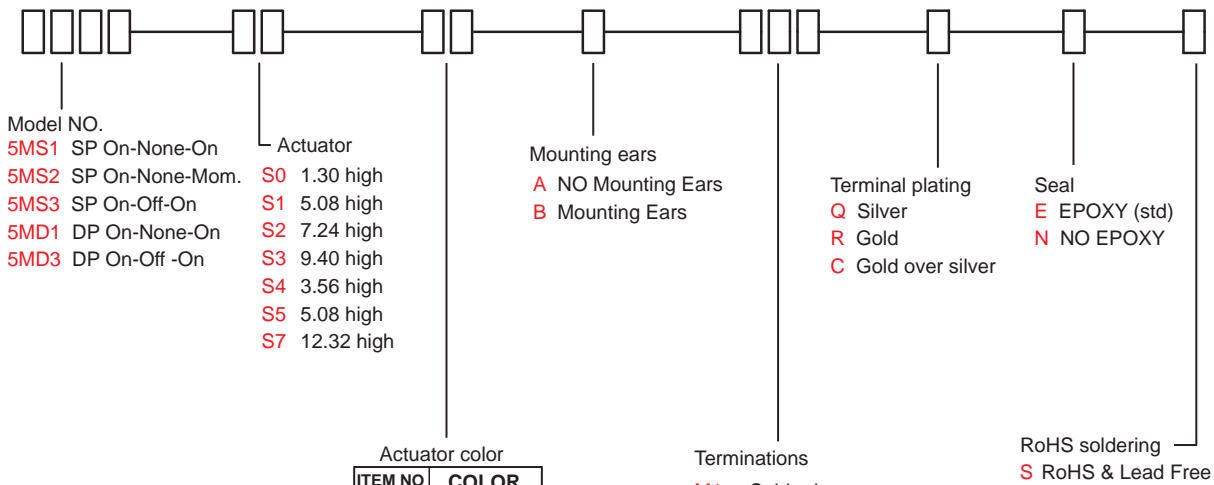

Actuator color

ITEM NO	COLOR
01	White
02	Black (Std)
03	Red
04	Orange
05	Yellow
06	Green
07	Blue
08	Brown
09	Gray

\* Besides standard color, other colors need to check stocks available.

Terminations

<b>M1</b>	Solder Lug
<b>M2</b>	PC thru-hole
<b>M3</b>	Quick Connect
<b>M51</b>	18.70 high, wire wrap
<b>M52</b>	24.20 high, wire wrap
<b>M53</b>	10.55 high, wire wrap
<b>M54</b>	26.97 high, wire wrap
<b>M6</b>	Right angle, PC thru-hole
<b>M7</b>	Vertical right angle, PC thru-hole
<b>VS2</b>	V-bracket

# 5M Series

Slide Switches

## SWITCH FUNCTION

NO. POLES	UL/CSA MODEL NO.	MODEL NO.	SWITCH FUNCTION			CONNECTED TERMINALS / SCHEMATIC		
			POS.1	POS.2	POS.3	POS.1	POS.2	POS.3
SP	Q1511	5MS1	ON	NONE	ON	2-1	N/A	2-3
	Q1512	5MS2	ON	NONE	MOM		OPEN	
	Q1513	5MS3	ON	OFF	ON			
DP	Q1521	5MD1	ON	NONE	ON	2-1,5-4	N/A	2-3,5-6
	Q1523	5MD3	ON	OFF	ON		OPEN	

MOM=MENTORY

## POLE OPTIONS

5M Slide Switches

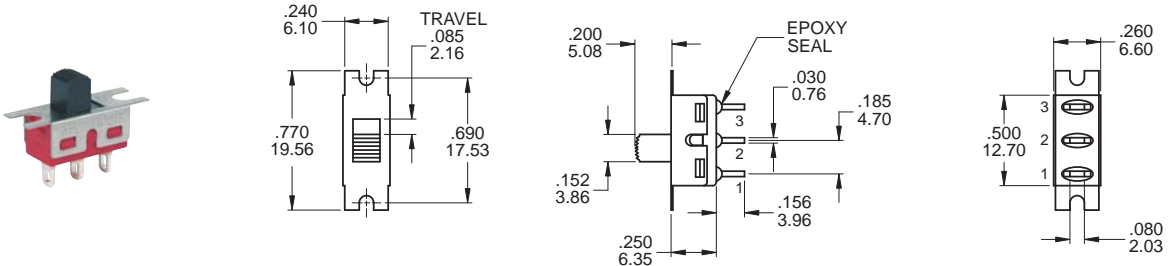

### SPDT

Part No. Shown : 5MS1S102BM1QES

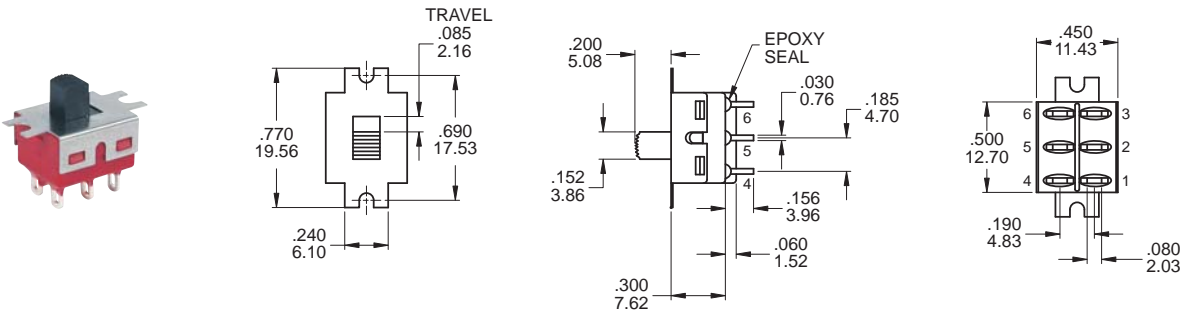

### DPDT

Part No. Shown : 5MD1S102BM1QES

## ACTUATOR OPTIONS

### S1 STD

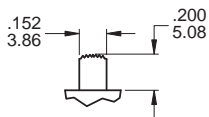

### S2

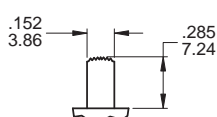

### S0 Only for S1,S2,D1,D3 model type

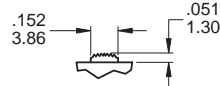

### FRONT

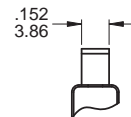

### ▲ S5 Only DPDT

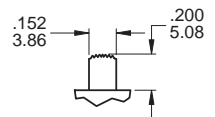

### S3

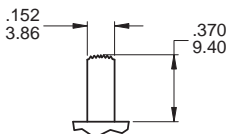

### S4

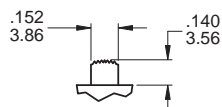

### S7

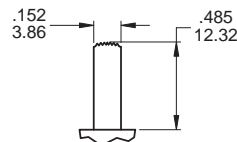

For S0,S1,S2,S3,S4 actuator

\* Subtract .014(0.36) from Actuator height for M6, M7 P.C. mounting option.

### FRONT

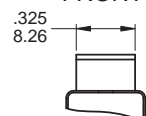

## TERMINATION OPTIONS

### M1 Solder lug

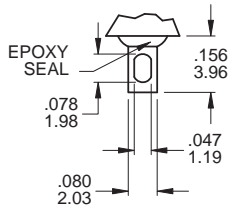

.030(0.76) THK.

### M2 PC Thru-hole

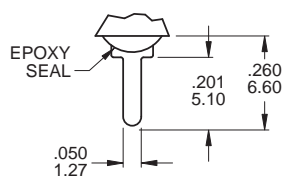

.030(0.76) THK.

### M3 Quick connect

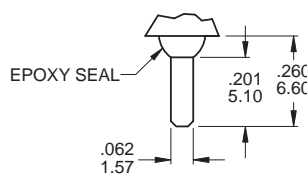

THK .030(0.76)

### M5 Wire Wrap

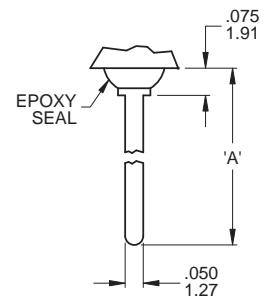

THK .030(0.76)

## OTHER TERMINATION OPTIONS

**M6** Right angle P.C. Mount

**M7** Right angle P.C. Mount

**VS2** Vertical bracket P.C. Mount

OPTION CODE	DIM. 'A'
M51	.736 (18.70)
M52	.953 (24.20)
M53	.415 (10.55)
M54	1.062 (26.97)

### M6

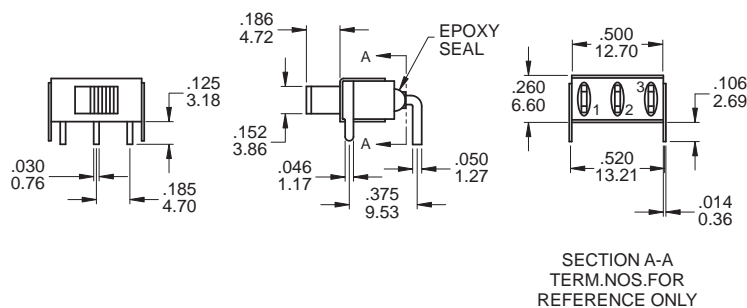

#### P.C. MOUNTING

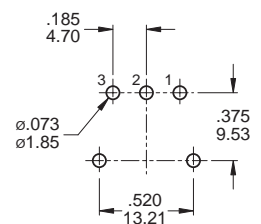

### SPDT

Part No. Shown : 5MS1S102AM6QES

### M6

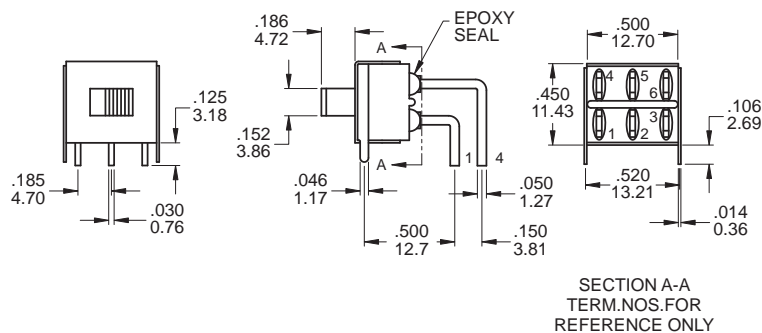

#### P.C. MOUNTING

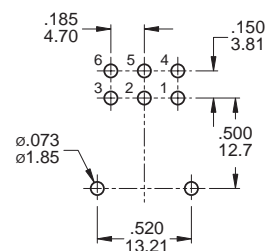

### DPDT

Part No. Shown : 5MD1S102AM6QES



5M  
Slide Switches

# 5M Series

Slide Switches

M7

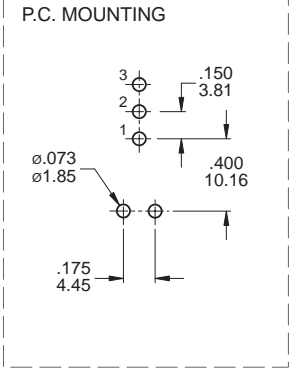
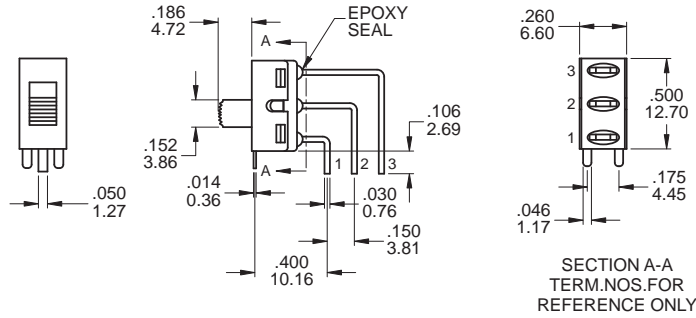

SPDT

Part No. Shown : 5MS1S102AM7QES

M7

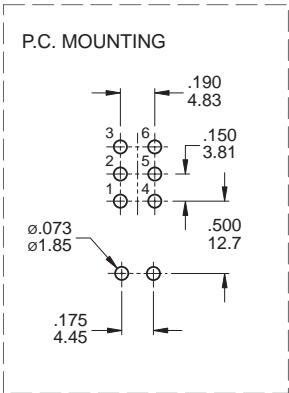
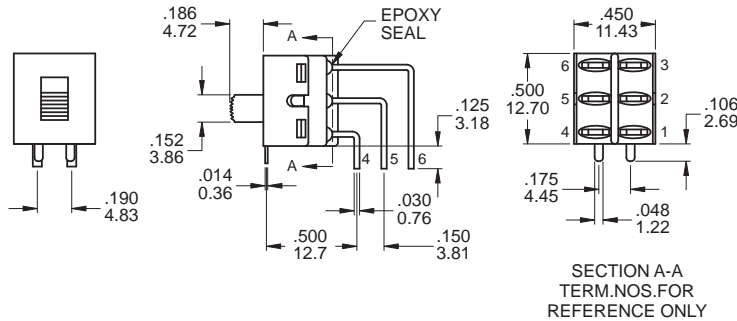
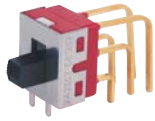

DPDT

Part No. Shown : 5MD1S102AM7RES

VS2

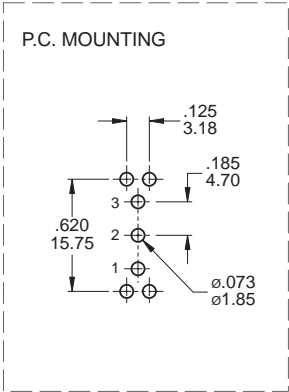
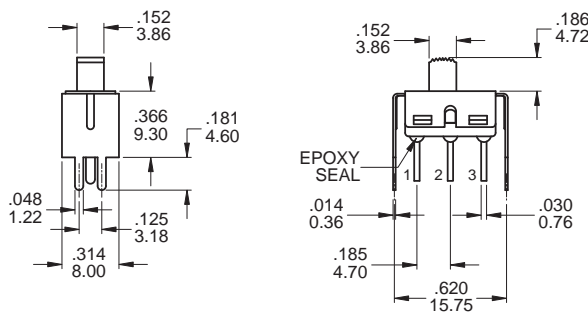
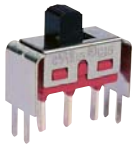

SPDT

Part No. Shown : 5MS1S102AVS2QES

VS2

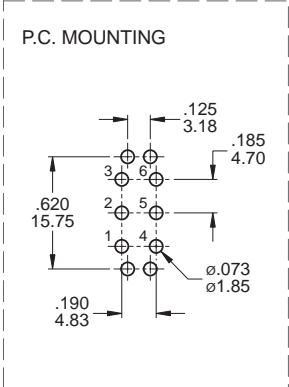
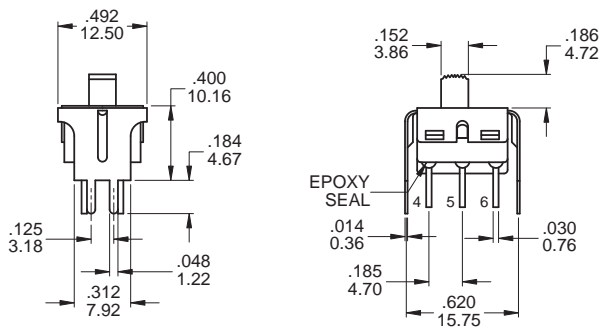
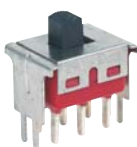

DPDT

Part No. Shown : 5MD1S102AVS2QES

**MOUNTING EARS / PANEL MOUNT**

**MOUNTING EARS**

"A" WITHOUT MOUNTING EARS

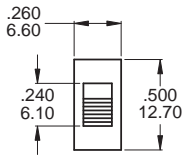

"B" WITH MOUNTING EARS

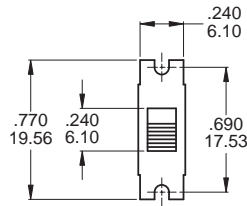

**THREE POSITIONS ONLY**

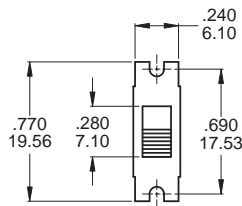
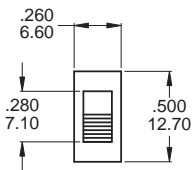

**PANEL MOUNTING**

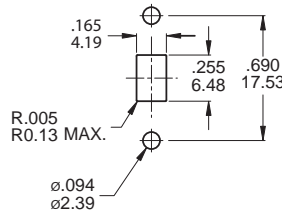

For S0,S1,S2,S3,S4 actuator

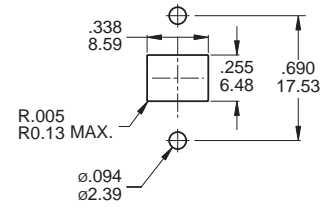

For S5 actuator only

**THREE POSITIONS ONLY**

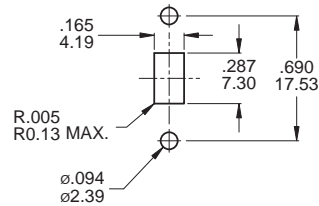

For S0,S1,S2,S3,S4 actuator

**CONTACT MATERIAL OPTIONS**

	CONTACT PLATING	TERMINAL PLATING	RATINGS
Q	Silver	Q = Silver	5 Amps with resistant load @ 120VAC or 28VDC 2 Amps with resistant load @ 250VAC
C	Gold over Silver	C = Gold over silver	
R	Gold	R = Gold	0.4 Volt - Amps ( VA ) max. @ 20V max. ( AC or DC )

**SOLDERING PROCESSES**

**MANUAL SOLDERING :** Use soldering iron of 30 watts, controlled at 350°C approximately 5 seconds while applying solder.

**WAVE SOLDERING :** Recommended Soldering Temperature : 270 ± 5°C

Duration of Solder Immersion : Max 5sec. (PCB is 1.6mm in thickness)



单击下面可查看定价，库存，交付和生命周期等信息

[>>Dailywell\(德利威\)](#)